

Bible Story 1

CREATION

GENESIS 1:1-2:25

1. CREATION

(GENESIS 1:1-2:25)

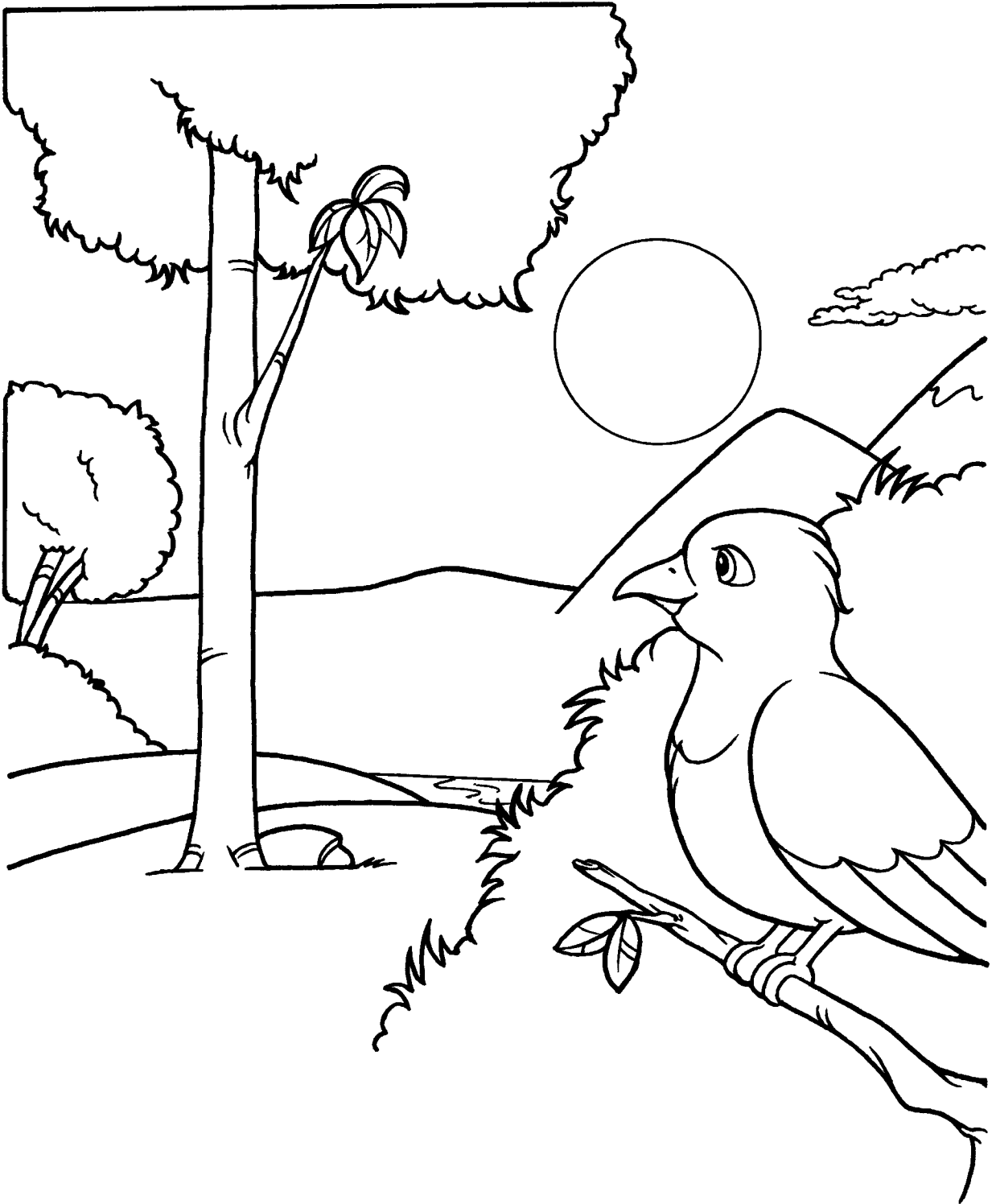

"And God made the beast of the earth after his kind,
and cattle after their kind, and every thing that creepeth
upon the earth after his kind: and God saw that it was good."

GENESIS 1:25

1. CREATION

(GENESIS 1:1-2:25)

MEMORY VERSE:

"In the beginning was the Word, and the Word was with God, and the Word was God. He was in the beginning with God. All things were made through Him, and without Him nothing was made that was made." JOHN 1:1-3

TRUE OR FALSE:

1. "In the beginning God created the heavens and the earth." **GENESIS 1:1**
TRUE OR FALSE
2. "The earth was without form, and void; and darkness was on the face of the deep. And the Spirit of God was hovering over the face of the waters." **GENESIS 1:2**
TRUE OR FALSE
3. "Then God said, 'Let there be light'; and there was light." **GENESIS 1:3**
TRUE OR FALSE

CIRCLE THE CORRECT WORDS:

4. "God called the light (**BRIGHT, DAY**), and the darkness He called (**NIGHT, SPACE**). So the evening and the morning were the first day." **GENESIS 1:5**
5. "And God called the firmament (**HEAVEN, EARTH**). So the evening and the morning were the second day." **GENESIS 1:8**
6. "And God called the dry land (**DIRT, EARTH**), and the gathering together of the waters He called (**SEAS, PUDDLES**). And God saw that it was good." **GENESIS 1:10**

TRUE OR FALSE:

7. Then God said, "Let the earth bring forth grass, the herb that yields seed, and the fruit tree that yields fruit according to its kind, whose seed is in itself, on the earth"; but it did not happen. **GENESIS 1:11**
TRUE OR FALSE
8. "Then God made two great lights: the greater light to rule the day, and the lesser light to rule the night. He made the stars also." **GENESIS 1:16**
TRUE OR FALSE
9. "So God created great sea creatures and every living thing that moves, with which the waters abounded, according to their kind, and every winged bird according to its kind. And God saw that it was good." **GENESIS 1:21**
TRUE OR FALSE

FILL IN THE BLANKS:

10. "Then God said, 'Let the earth bring forth the living creature according to _____, cattle and creeping thing and beast of the earth, each according to _____'; and it was so." **GENESIS 1:24**
11. "Then God said, 'Let _____ make man in _____ image, according to _____ likeness.'" **GENESIS 1:26**

1. CREATION

(GENESIS 1:1-2:25)

S A D A M L M O O N T E V E T
 E E U A I F I C Y V D O O G N
 V A I G Y R I D J C E O K Y E
 E R H I Q N S N E V A E H L D
 N T S E R U T A E R C P T P R
 D H H S I F K N A M K F E I A
 A A K O T Y W O M A N D F T G
 Y G E W F M N S R E T A W L O
 S D O G F O T I R I P S Y U N
 I Q Y A V D E T S E R H R M G
 J F D E T A E R C U S D S N O
 E S T A R S M N D A U F D L D
 B E G I N N I N G U N W R M K
 F H B E I Z T H G I N Y I A V
 S W T P E L T T A C O S B X E

- | | | | |
|-----------|---------|----------|---------------|
| ADAM | EARTH | LIGHT | SEVEN DAYS |
| BEGINNING | EVE | MAN | SPIRIT OF GOD |
| BIRDS | FISH | MOON | STARS |
| CATTLE | GARDEN | MULTIPLY | SUN |
| CREATED | GOD | NIGHT | WATERS |
| CREATURES | GOOD | RESTED | WOMAN |
| DAY | HEAVENS | | |

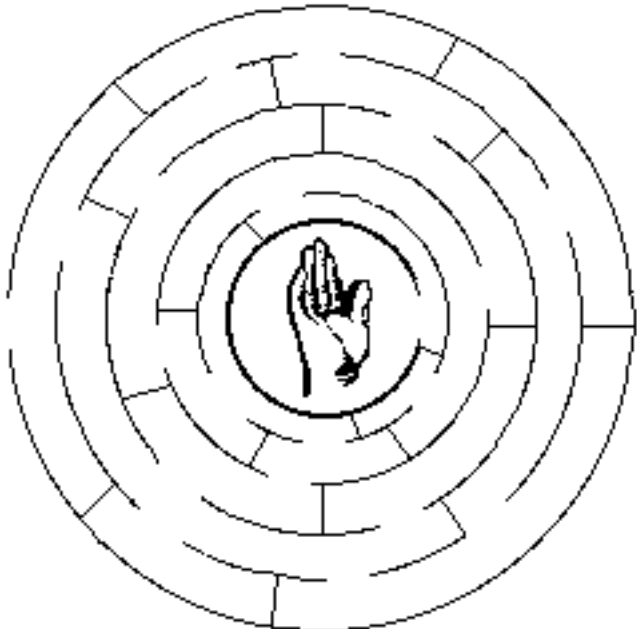

1. CREATION

(GENESIS 1:1-2:25)

MEMORY VERSE:

"In the beginning was the Word, and the Word was with God, and the Word was God. He was in the beginning with God. All things were made through Him, and without Him nothing was made that was made." JOHN 1:1-3

TRUE OR FALSE:

1. "In the beginning God created the heavens and the earth." **GENESIS 1:1**
TRUE OR FALSE
2. "The earth was without form, and void; and darkness was on the face of the deep. And the Spirit of God was hovering over the face of the waters." **GENESIS 1:2**
TRUE OR FALSE
3. "Then God said, 'Let there be light'; and there was light." **GENESIS 1:3**
TRUE OR FALSE

FILL IN THE BLANKS:

4. "God called the light _____, and the darkness He called _____. So the evening and the morning were the first day." **GENESIS 1:5**
5. "And God called the firmament _____. So the evening and the morning were the second day." **GENESIS 1:8**
6. "And God called the dry land _____, and the gathering together of the waters He called _____. And God saw that it was good." **GENESIS 1:10**

TRUE OR FALSE:

7. Then God said, "Let the earth bring forth grass, the herb that yields seed, and the fruit tree that yields fruit according to its kind, whose seed is in itself, on the earth"; but it did not happen. **GENESIS 1:11**
TRUE OR FALSE
8. "Then God made two great lights: the greater light to rule the day, and the lesser light to rule the night. He made the stars also." **GENESIS 1:16**
TRUE OR FALSE
9. "So God created great sea creatures and every living thing that moves, with which the waters abounded, according to their kind, and every winged bird according to its kind. And God saw that it was good." **GENESIS 1:21**
TRUE OR FALSE

FILL IN THE BLANKS:

10. "Then God said, 'Let the earth bring forth the living creature according to _____, cattle and creeping thing and beast of the earth, each according to _____'; and it was so." **GENESIS 1:24**
11. "Then God said, 'Let _____ make man in _____ image, according to _____ likeness.'" **GENESIS 1:26**

1. CREATION (GENESIS 1:1-2:25)

L S K T Y I W V M U E A S T T B C L G J F U T Q U
 O L O D Q E A B Q N H O P W K V G J J A V C T A E
 Z P B D U P F G E U T A T I W S S T P V Y Q C O D
 M U H Q Q S M C B L L H E A V E N S Z K A N M Y K
 F T T C T I P I N D T P W H I U Q W F U D R P E G
 M N F H H Y R I Y L U T E A R T H N A M O W M A C
 Q D V U G D T Z R U W A A J U B U K D E T A E R C
 S R I J S I O H M I Q M B C M H M M B O F U L E M
 Q A O K T B N K A F T D A D F U S L B Z H K C Q N
 V Z N S T B M K S L N O H N O Q E U K Y N B S U Q
 P E H M L I G H T Y D Y F U E T V G M L E I G T R
 B M I J R P J R V H I E J G P P E C Z P E F E V U
 Q D U T R P S E Y B S S T O O L N V B I M W Y S M
 J W G A W Y R N K O V M Y S K D D U I T J L U N E
 I Q A A P F A B W I U U K L E J A B Z L Q J W U S
 C B F A R O T C E R U B P O J R Y N F U V B I S Z
 T I F U N D S V L G A S G U G B S H Z M E B A E P
 C T T E B J E C W M I E K O F J S B B B V K C T J
 J A Q N B W N N A F D N D I Y H R A D A V J L K H
 W L H Q C O B D W Y D J N I T T E U K M L K P N D
 Y B A B O S A D Z B W M G I W J T V B Z A U A B C
 J Z U M D S G C O D E G P B N Y A A U B I M I Y U
 T Z U N W I H H O O T V S R U G W E Y T L B E Z U
 N F I S H A G R A F G O E W G R J I E P R Y Y A S
 A N T A K G D E K B L V O G H D Q S E Z U R A B Y

ADAM

BEGINNING

BIRDS

CATTLE

CREATED

DAY

EARTH

EVE

FISH

GARDEN

GOD

GOOD

HEAVENS

LIGHT

MAN

MOON

MULTIPLY

NIGHT

RESTED

SEVEN DAYS

SPIRIT OF GOD

STARS

SUN

WATERS

WOMAN

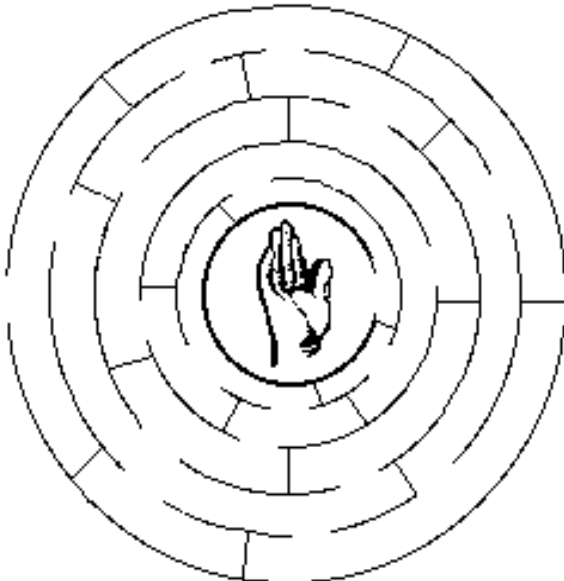

1. CREATION

(GENESIS 1:1-2:25)

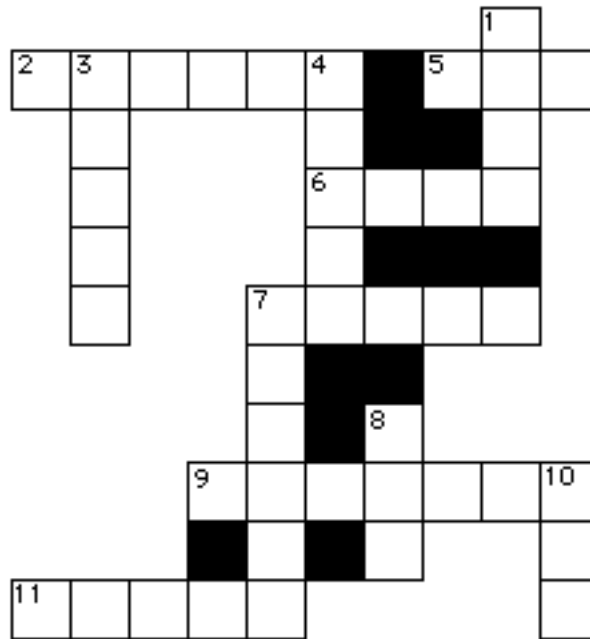

- 9 ACROSS "In the beginning God _____ the heavens and the earth." **GENESIS 1:1**
- 7 DOWN "And the ____ of God was hovering over the face of the waters." **GENESIS 1:2**
- 11 ACROSS "Then God said, 'Let there be _____'" **GENESIS 1:3**
- 10 DOWN "God called the light _____," **GENESIS 1:5**
- 4 DOWN "and the darkness He called _____." **GENESIS 1:5**
- 2 ACROSS On the second day, God called the firmament _____ **GENESIS 1:8**
- 3 DOWN "And God called the dry land _____," **GENESIS 1:10**
- 5 ACROSS "Then ____ made two great lights: the greater light to rule the day, and the lesser light to rule the night." **GENESIS 1:16**
- 7 ACROSS "He made the ____ also." **GENESIS 1:16**
- 6 ACROSS "So God created great sea creatures and every living thing that moves, with which the waters abounded, according to their kind, and every winged bird according to its kind. And God saw that it was _____." **GENESIS 1:21**
- 8 DOWN "Then God said, 'Let Us make__ in Our image, according to Our likeness.'" **GENESIS 1:26**
- 1 DOWN "In the beginning was the Word, and the Word was with God, and the _____ was God. He was in the beginning with God. All things were made through Him, and without Him nothing was made that was made." **JOHN 1:1-3**

Bible Story 2

**GOD MAKES
ADAM & EVE**

GENESIS 1:26-4:1

2. GOD MAKES ADAM AND EVE

(GENESIS 1:26-4:1)



"So God created man in His own image; in the image of
God He created him; male and female He created them."

GENESIS 1:27

2. GOD MAKES ADAM AND EVE (GENESIS 1:26-4:1)

MEMORY VERSE:

"So God created man in His own image; in the image of God He created him; male and female He created them." GENESIS 1:27

CIRCLE THE CORRECT WORDS:

1. "Then God said, 'Let Us make man in Our image, according to Our likeness; let him have dominion over...' " GENESIS 1:26

fish
cattle

birds
mountains

stars
creeping things

TRUE OR FALSE:

2. "So God created man in His own image; in the image of God He created him; male and female He created them." GENESIS 1:27

TRUE OR FALSE

3. "And the LORD God formed man of the dust of the ground, and breathed into his nostrils the breath of life; and man became a living being." GENESIS 2:7

TRUE OR FALSE

4. And the Lord God said, "It is good that man is alone..." GENESIS 2:18

TRUE OR FALSE

CIRCLE THE CORRECT WORDS:

5. "And the LORD God caused a deep sleep to fall on Adam, and he slept; and He took one of his (**EARS, RIBS**) and closed up the flesh in its place." GENESIS 2:21

6. "Then the (**EAR, RIB, TOOTH**) which the LORD God had taken from the man He made into a woman, and He brought her to the man." GENESIS 2:22

TRUE OR FALSE:

7. "And Adam called his wife's name Eve, because she was the mother of all living."

GENESIS 3:20

TRUE OR FALSE

2. GOD MAKES ADAM AND EVE (GENESIS 1:26-4:1)

V Y L P I T L U M W O M A N L
H E L P E R G A T E I E V O T
W U U E M A N A H I V E R I N
Z C R E A T E D R E U D I M E
D V D E V I E C E D G R F N P
F O S G N M A N W O E P F M R
I Y M R T Q J G D Y O N R C E
Z Y S I Q T E Q E F I W N D S
T S S E N E K I L R U O D N M
M R F A C I A D A M W N Y O C
G E G A M I O F U B A Q T T U
G T J S D B F N I B A H S Y A
F R U I T F U L S T E U M J U
R E S F Y B S U B R D T Z D T
H R I B R I H T R E E F U V E

ADAM
CREATED
DECEIVED
DOMINION
DUST
EVE

FRUITFUL
FRUIT
GARDEN
HELPER
HUSBAND
IMAGE

LORD GOD
MAN
MOTHER
MULTIPLY
NAME
OUR LIKENESS

RIB
SERPENT
TREE
WIFE
WOMAN

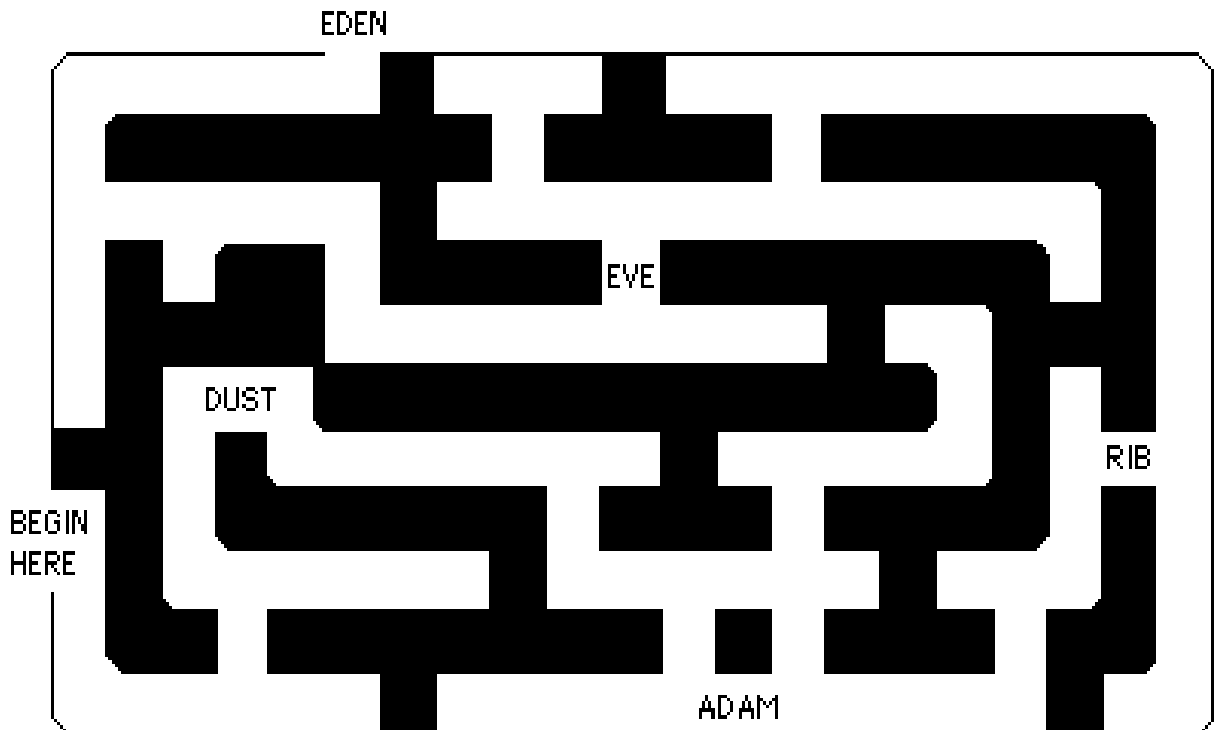

2. GOD MAKES ADAM AND EVE (GENESIS 1:26-4:1)

MEMORY VERSE:

"So God created man in His own image; in the image of God He created him; male and female He created them." GENESIS 1:27

CIRCLE THE CORRECT WORDS:

1. "Then God said, 'Let Us make man in Our image, according to Our likeness; let him have dominion over...'" **GENESIS 1:26**

fish
cattle

birds
mountains

stars
creeping things

FILL IN THE BLANKS:

2. "So _____ man in His own image; in the image of God _____ him; male and female _____ them." **GENESIS 1:27**

TRUE OR FALSE:

3. "And the LORD God formed man of the dust of the ground, and breathed into his nostrils the breath of life; and man became a living being." **GENESIS 2:7**

TRUE OR FALSE

4. And the Lord God said, "It is good that man is alone..." **GENESIS 2:18**

TRUE OR FALSE

FILL IN THE BLANKS:

5. "And the LORD God caused a deep _____ to fall on Adam, and he slept; and He took one of his _____ and closed up the flesh in its place." **GENESIS 2:21**

6. "Then the _____ which the LORD God had taken from the man He made into a woman, and He brought her to the man." **GENESIS 2:22**

7. "And Adam called his wife's name _____, because she was the mother of all living." **GENESIS 3:20**

2. GOD MAKES ADAM AND EVE

(GENESIS 1:26-4:1)

G B V A O J N G R O T M W K T U I Z L C Q B K M H Z N M V I
 S O C S B K K W E A L U I J J B Z B R M A U R T L Y J T R L
 N S A L H S B A N K U B H F Y N F A U P O E B F Q E L Q R E
 B L L P N M C F C D I S J F R U I T F U L D N H U H D V K I
 K K O A F J O U V M E E D Y R H S M B M Y K Y D I Z R U J A
 K W M E V T D U A U W T U T D B E Z C L E G N R C C Z G S K
 O O Z U M A W G R N Q J A W C A R B Q C T S U D C S B B F Q
 W V M T I A E T C L N M O E G U P T N S A C M S T I U R F Y
 J J F N O A N O C U I G L U R V E P R G E D N A B S U H Q R
 Q B M D N U K M H D I K O G S C N Z U E Q M Q M M G Y D V B
 S W Q R H E I J R L S O E H Q A T F K Y M N P C R I A O B T
 P E S A I N E K E U V V U N U E Z V B U U Q L N B F E N R P
 M L Q Z U Q P G M F U S R B E I B F I W L R J O G L M Z B K
 B V V E A T R E E L U P I E M S D H F I T U D I B B B F I Z
 B D P M F B I M Q Y A T I V P S S N W A I M D N I K W I F E
 O D B D F N Y A N H D W B S J L K E L C P E R I V M Z N U O
 H Z G W T A B D D B D B R U Q G E E J L L S M M S I U B Q V
 S Z Q A Q Y B A Y E W H W B L J B H B P Y Z J O M U I A H L
 S O J Q R Q P H M O C J G H J P U M B A U P L D K B J D C C
 R W I B H D P G A I T E T U T Z Y J K I T J P U I W L P C Y
 V H C I A U E D S R L Y I R E H T O M D V H O R R V M U N Y
 N Q T T U Q Y N V F A K K V W F E Q J O S D L S K K P K U P
 G I C A U T F V Y Y O P W Q E B E V K G E C T J Q G B I K D
 D L J L T H O B K B A G I T K D J E U D T U P L Y P E B S D
 P H W B T T J G B D P K U P M B V E M R K U N P C H C R U A
 K T Y Z D T W C W I A G M L L E A V B O N S R B Z K H Q N W
 S Y J Z D R S Z L F R P F J U K V V Y L B Y A N A H M I E Z
 P M A N Q R S H W B D S O B G M K L R E Y J P S K C B J S C
 P O T N C W I K W E Y O E J C Z U A T Y Z G L L R O I L B P
 R A N K U P A K Z H S T P H V B O I T A A A B P V V J T Y

ADAM
 CREATED
 DECEIVED
 DOMINION
 DUST
 EVE

FRUIT
 FRUITFUL
 GARDEN
 HELPER
 HUSBAND
 IMAGE

LORD GOD
 MAN
 MOTHER
 MULTIPLY
 NAME
 OUR LIKENESS

RIB
 SERPENT
 TREE
 WIFE
 WOMAN

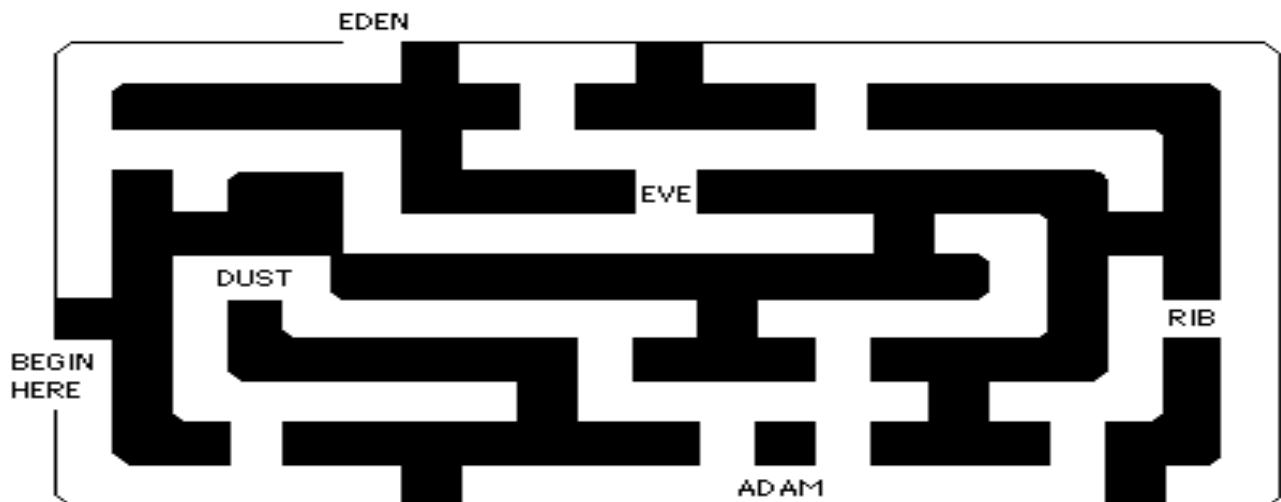

2. GOD MAKES ADAM AND EVE

(GENESIS 1:26-4:1)

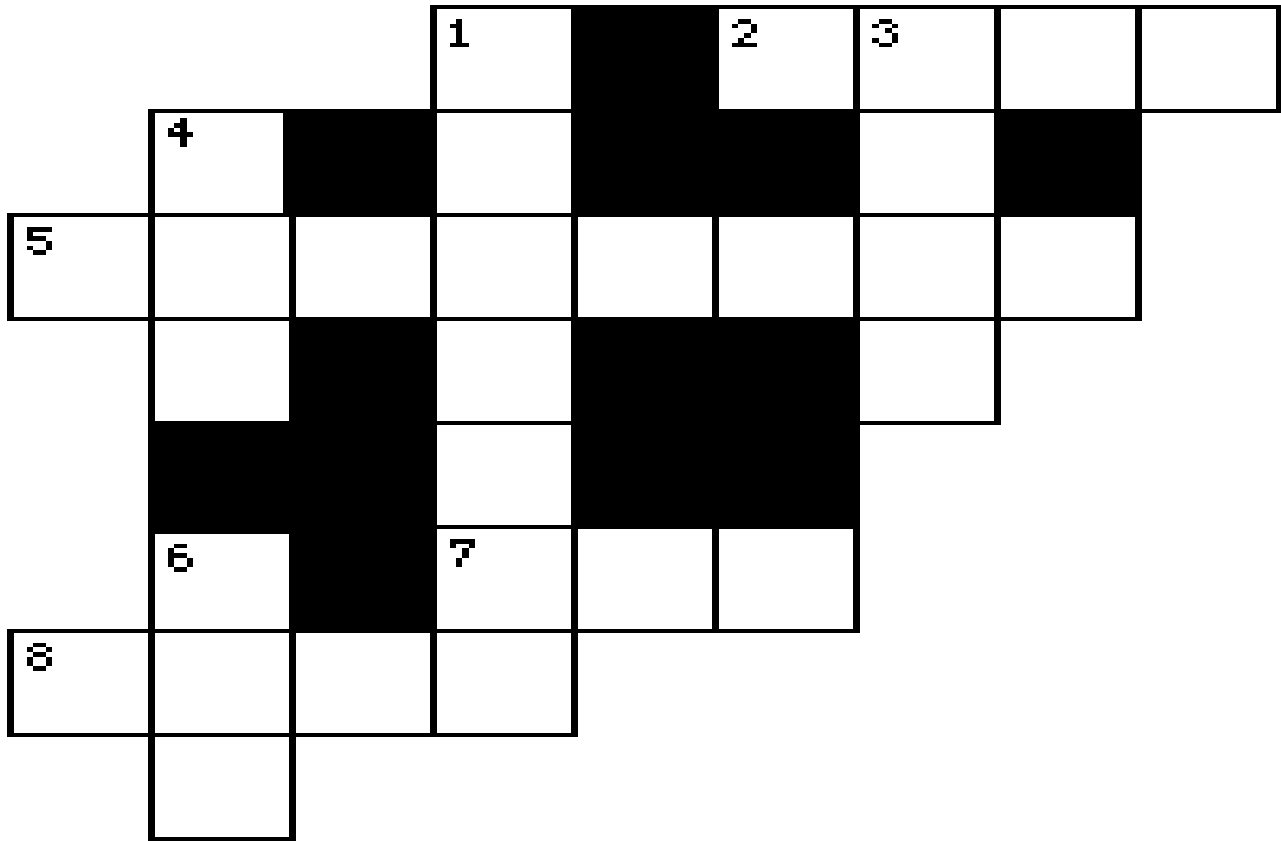

- 5 ACROSS Then God said, "Let Us make man in Our image, according to Our _____."
GENESIS 1:26
- 6 DOWN "So _____ created man in His own image; in the image of God He created him; male and female He created them." **GENESIS 1:27**
- 3 DOWN "And the LORD God formed man of the _____ of the ground, and breathed into his nostrils the breath of life; and man became a living being." **GENESIS 2:7**
- 8 ACROSS And the Lord God said, "It is not _____ that man is alone." **GENESIS 2:18**
- 2 ACROSS "And the LORD God caused a deep sleep to fall on _____, and he slept; and He took one of his ribs and closed up the flesh in its place." **GENESIS 2:21**
- 4 DOWN "Then the _____ which the LORD God had taken from the man He made into a woman, and He brought her to the man." **GENESIS 2:22**
- 7 ACROSS "And Adam called his wife's name _____, because she was the mother of all living."
GENESIS 3:20
- 1 DOWN "So God _____ man in His own image; in the image of God He created him; male and female He created them." **GENESIS 1:27**

Bible Story 3

THE GARDEN OF EDEN

GENESIS 2:8-17

3. THE GARDEN OF EDEN (GENESIS 2:8-17)

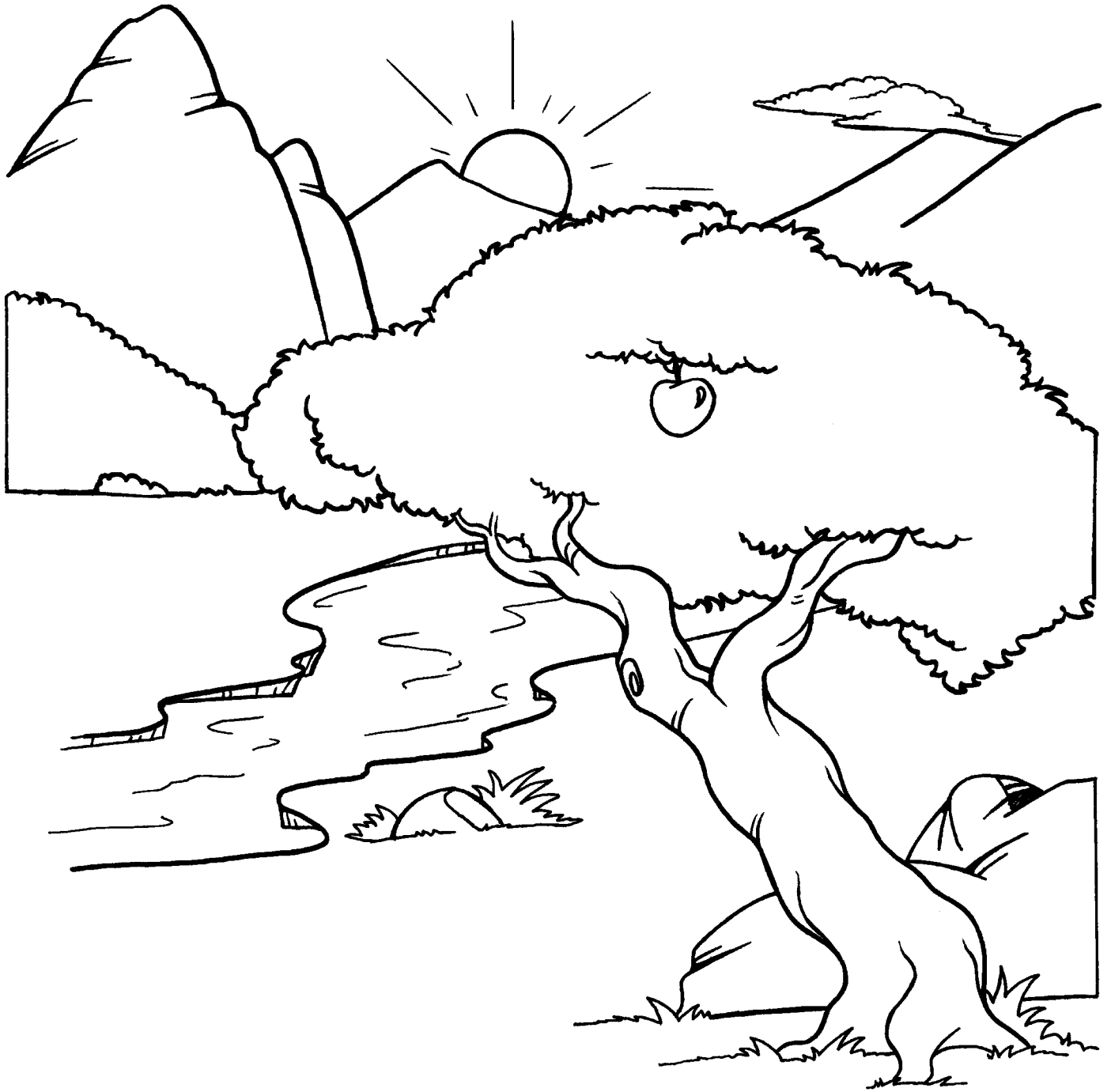

"And the LORD God commanded the man, saying, 'Of every tree of the garden you may freely eat; but of the tree of the knowledge of good and evil you shall not eat, for in the day that you eat of it you shall surely die.' "

GENESIS 2:16-17

3. THE GARDEN OF EDEN (GENESIS 2:8-17)

MEMORY VERSE:

"The LORD God planted a garden eastward in Eden, and there He put the man whom He had formed." GENESIS 2:8

CIRCLE THE CORRECT WORD:

1. "The LORD God planted a garden eastward in (**SWEDEN, EDEN**), and there He put the man whom He had formed." GENESIS 2:8

UNDERLINE THE CORRECT ANSWER:

2. "And out of the ground the LORD God made..." GENESIS 2:9
a. every tree grow that is pleasant to the sight and good for food
b. The tree of life was also in the midst of the garden
c. and the tree of the knowledge of good and evil
d. All of the above

CIRCLE THE CORRECT WORD:

3. "Now a (**GARDENHOSE, RIVER**) went out of Eden to water the garden, and from there it parted and became four riverheads." GENESIS 2:10

TRUE OR FALSE:

4. WRITE A T FOR TRUE OR AN F FOR FALSE

"The name of the first river is Pishon..." GENESIS 2:11 _____

"The name of the second river is Gihon..." GENESIS 2:13 _____

The name of the third river is Mississippi... GENESIS 2:14 _____

"...The name of the fourth river is Euphrates." GENESIS 2:14 _____

5. "Then the LORD God took the man and put him in the garden of Eden to tend and keep it." GENESIS 2:15

TRUE OR FALSE

CIRCLE THE CORRECT WORD:

6. "And the LORD God commanded the man, saying, 'Of every tree of the garden you may freely eat; but of the tree of the knowledge of good and evil you shall not eat, for in the day that you eat of it you shall surely (**LIVE, DIE**).'" GENESIS 2:16-17

3. THE GARDEN OF EDEN (GENESIS 2:8-17)

N D E T N A L P T B V L M M R
 O A R P G E P S M U Z O B A K
 G J M T F V A M O L K R P D K
 I S Y E K E B C E N E D R A G
 H U S E T A R H P U E G C E Y
 O I Y V D G V Z M R F O D I R
 N E D R B O F O O D I D T K G
 K A D D K L Q L B P K V B B I
 Q L I V E D N A D O O G E P K
 K V N F K K D O N M S T B R U
 L D E E A L E U H C M M D P A
 W Q D J T A V L O S O Z N U V
 T R E E O F L I F E I J E Z B
 K E J O W P N A M C A P T V O
 I N I U S L A M I N A S G F U

ADAM
 ANIMALS
 EDEN
 EUPHRATES
 EVE
 FOOD
 GARDEN

GIHON
 GOLD
 GOOD AND EVIL
 HIDDEKEL
 LORD GOD
 MAN
 NAME

PISHON
 PLANTED
 RIVER
 TEND
 TREE OF LIFE
 TREE

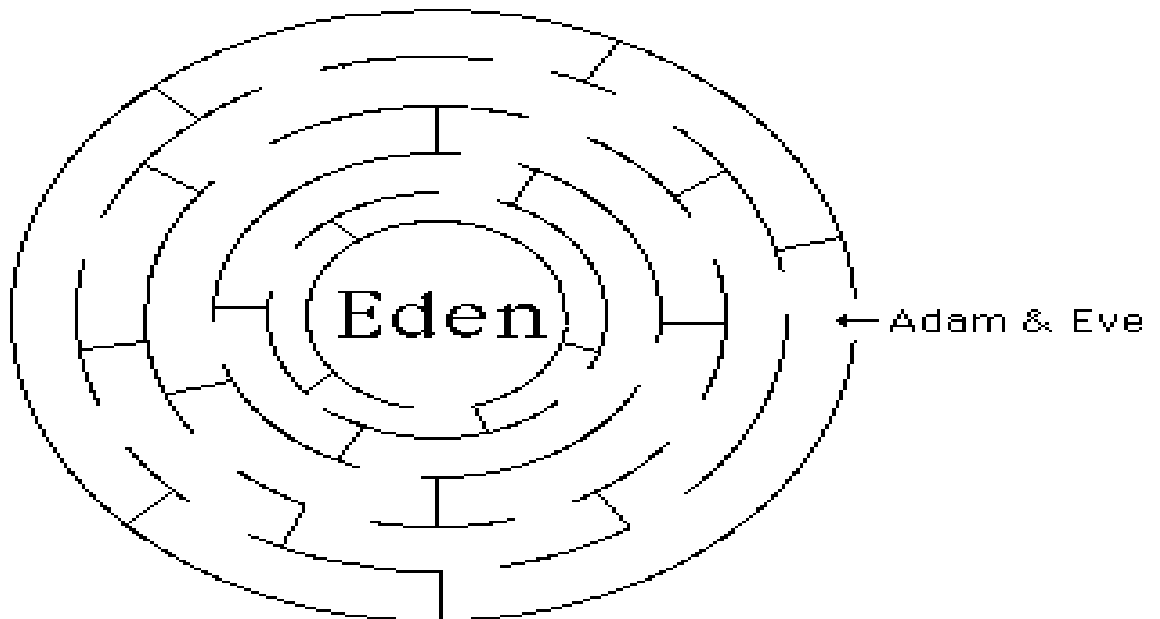

3. THE GARDEN OF EDEN (GENESIS 2:8-17)

MEMORY VERSE:

"The LORD God planted a garden eastward in Eden, and there He put the man whom He had formed." GENESIS 2:8

FILL IN THE BLANK:

1. "The LORD God planted a garden eastward in _____, and there He put the man whom He had formed." **GENESIS 2:8**

UNDERLINE THE CORRECT ANSWER:

2. "And out of the ground the LORD God made..." **GENESIS 2:9**
a. every tree grow that is pleasant to the sight and good for food
b. The tree of life was also in the midst of the garden
c. and the tree of the knowledge of good and evil
d. All of the above

FILL IN THE BLANK:

3. "Now a _____ went out of Eden to water the garden, and from there it parted and became four riverheads." **GENESIS 2:10**

TRUE OR FALSE:

4. WRITE A T FOR TRUE OR AN F FOR FALSE

"The name of the first river is Pishon..." **GENESIS 2:11** _____

"The name of the second river is Gihon..." **GENESIS 2:13** _____

The name of the third river is Mississippi... **GENESIS 2:14** _____

"...The name of the fourth river is Euphrates." **GENESIS 2:14** _____

5. "Then the LORD God took the man and put him in the garden of Eden to tend and keep it." **GENESIS 2:15**

TRUE OR FALSE

FILL IN THE BLANKS:

6. "And the LORD God commanded the man, saying, 'Of every tree of the garden you may freely eat; but of the tree of the knowledge of good and evil you shall not eat, for in the day that you eat of it _____.' " **GENESIS 2:16-17**

3. THE GARDEN OF EDEN (GENESIS 2:8-17)

O S Y C M I Q B W G K K O V B K W F L M E Y E W Y
 J L O T D O C N K W R W I U S G G O J L I E M L U
 Q K A C W N U A D A E L R U E P T E B U S E J J W
 S W V J Q G J Y T O N A N I M A L S J G G J Q B I
 P V R W B H O R I F G W F A J S K P H C J A V B A
 M J C E I I E O E U C D F O O D W N E D E V E K C
 B B A Y V E K Q D T V W R D M O I K D E T N A L P
 B W L J S I S U P A C Z Y O G T U J T V P K V J L
 O E O T T U R Q I O N O X D L W E F J U Z U V K P
 H L Z N A A M T Y M C D D W O I U Y Y L F O L U A
 S E V E N A M E B J N A E T V H P T R E B Z A M I
 S V M A L F J H B K H E F V S J H W D K B B I B E
 R D F S B F M T P G R K D L I D R U C E K A L Y Y
 V D G L Z T A T P H E U B R P L A G G D M M R R A
 N Z M I Z Q D T Y G M N E A A U T H S D Z Z U T Q
 G Z Q P H H A R R D Q U H O T G E M Q I B B U T A
 D O S U N O T R F E N D T A W O S V U H I T C C O
 P W Q T K A N W O V E L L P B L N S M B Z P Q M Y
 K H V N O U N P J B Y O U A H O O U J N F Z N P E
 S Q P D B A A N W G M U F D J U H B Q H Z F R M A
 P I B R M U A D S C A F W L Y I S H L B B V U L E
 P L Q A H T U K L Z S L Q Y I I I U J A D F N M Q
 R H J Z F T E B S O V Y N S K F P Q T U K H B S U
 B T E N D D N C I H G H I M P B E T W V B N I G T
 O T I E V D Q D A K Y B S U G R M P K A U E F E V

ADAM
 ANIMALS
 EDEN
 EUPHRATES
 EVE
 FOOD
 GARDEN

GIHON
 GOLD
 GOOD AND EVIL
 HIDDEKEL
 LORD GOD
 MAN
 NAME

PISHON
 PLANTED
 RIVER
 TEND
 TREE OF LIFE
 TREES

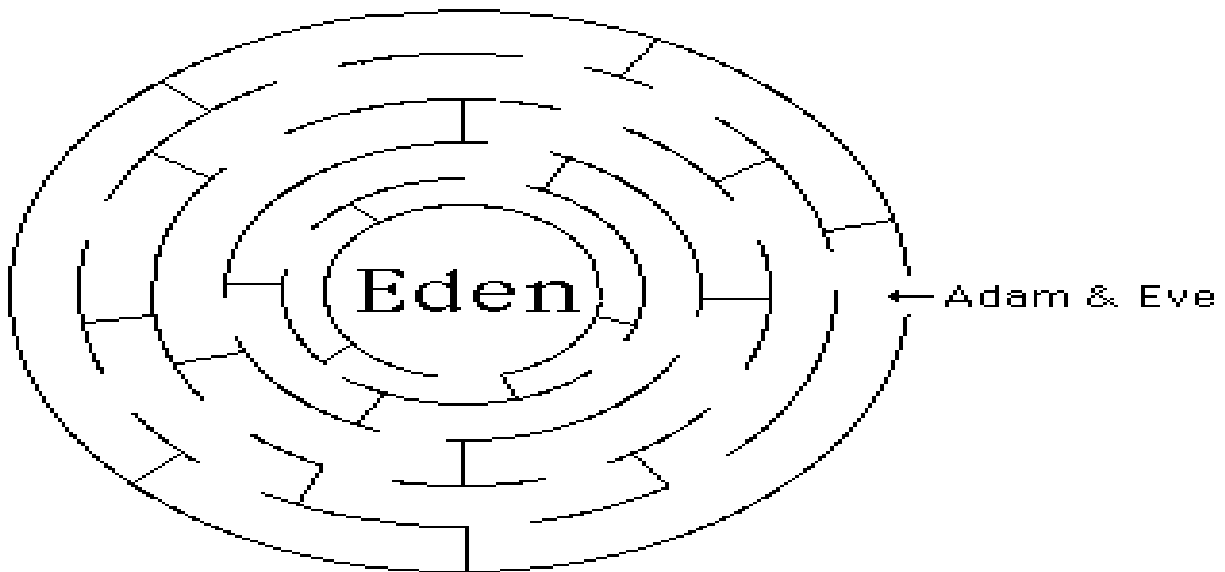

3. THE GARDEN OF EDEN (GENESIS 2:8-17)

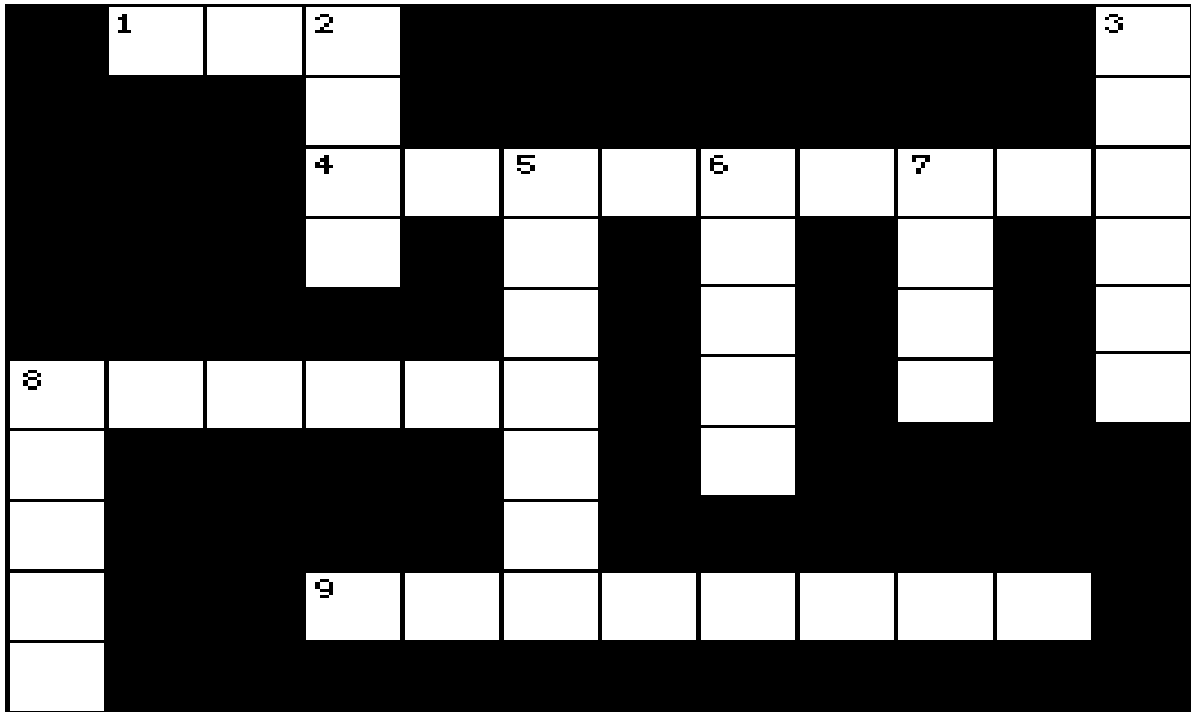

8 ACROSS "The LORD God planted a _____ eastward in Eden, and there He put the man whom He had formed." **GENESIS 2:8**

7 DOWN And out of the ground the LORD God made every _____ grow that is pleasant to the sight and good for food, the tree of life, and the tree of the knowledge of good and evil.
GENESIS 2:9

6 DOWN "Now a _____ went out of Eden to water the garden, and from there it parted and became four riverheads." **GENESIS 2:10**

3 DOWN "The name of the first river is _____." **GENESIS 2:11**

8 DOWN "The name of the second river is _____." **GENESIS 2:13**

9 ACROSS "The name of the third river is _____." **GENESIS 2:14**

4 ACROSS "The name of the fourth river is _____." **GENESIS 2:14**

2 DOWN "Then the LORD God took the man and put him in the garden of _____ to tend and keep it." **GENESIS 2:15**

1 ACROSS "And the LORD God commanded the man, saying, 'Of every tree of the garden you may freely eat; but of the tree of the knowledge of good and evil you shall not eat, for in the day that you eat of it you shall surely _____.'" **GENESIS 2:16-17**

5 DOWN "The LORD God _____ a garden eastward in Eden, and there He put the man whom He had formed." **GENESIS 2:8**

Bible Story 4

ADAM & EVE ARE TEMPTED

GENESIS 3:1-4:1

4. ADAM AND EVE ARE TEMPTED

(GENESIS 3:1-4:1)



"And they heard the sound of the LORD God walking in the garden in the cool of the day, and Adam and his wife hid themselves from the presence of the LORD God among the trees of the garden."

GENESIS 3:8

4. ADAM AND EVE ARE TEMPTED (GENESIS 3:1-4:1)

MEMORY VERSE:

"But I fear, lest somehow, as the serpent deceived Eve by his craftiness, so your minds may be corrupted from the simplicity that is in Christ." 2 CORINTHIANS 11:3

TRUE OR FALSE:

1. "Now the serpent was more cunning than any beast of the field which the LORD God had made. And he said to the woman, 'Has God indeed said, "You shall not eat of every tree of the garden?" ' " **GENESIS 3:1**
TRUE OR FALSE
2. "And the serpent said to the woman, 'You will surely not die.' " **GENESIS 3:4**
TRUE OR FALSE

CIRCLE THE CORRECT WORDS:

3. "So when the woman saw that the tree was good for food, that it was pleasant to the (**EYE, NOSE**), and a tree desirable to make one (**WISE, FOOLISH**), she took of its fruit and ate..." **GENESIS 3:6**

TRUE OR FALSE:

4. ...She also gave to her husband with her, but he did not eat. **GENESIS 3:6**
TRUE OR FALSE

CIRCLE THE CORRECT WORDS:

5. "And they heard the sound of the LORD God walking in the garden in the cool of the day, and Adam and his wife (**HIT, HID**) themselves from the presence of the LORD God among the (**TREES, ANIMALS**) of the garden." **GENESIS 3:8**

TRUE OR FALSE:

6. "Then the LORD God called to Adam and said to him, 'Where are you?' " **GENESIS 3:9**
TRUE OR FALSE
7. "Then the man said, 'The woman whom You gave to be with me, she gave me of the tree, and I ate.'
GENESIS 3:12
TRUE OR FALSE

CIRCLE THE CORRECT WORD:

8. "...And the woman said, 'The (**MAN, SERPENT**) deceived me, and I ate.' " **GENESIS 3:13**

TRUE OR FALSE: WRITE T FOR TRUE OR F FOR FALSE:

9. "So the LORD God said,..."
to the serpent... "You are cursed more than all cattle and every beast..." **GENESIS 3:14** _____
to the woman... "I will greatly multiply your sorrow..." **GENESIS 3:16** _____
to Adam... "Blessed is the ground for your sake..." **GENESIS 3:17** _____

4. ADAM AND EVE ARE TEMPTED

(GENESIS 3:1-4:1)

G N E D R A G E T P F E B L C
 F O M M W T Z V P T S D E E S
 L P D S E Y E E G D U W K W H
 L A D A M E Y H D O E N S J U
 M G G N I N N U C I O S I U E
 S K D E J J Y A L J A D R C C
 O B L L I K O H J H W R U U S
 P U S B U D J Z C Q U E B O C
 E E F I L F O E E R T T H A N
 N L I V E S I W V O D N P E Q
 E K V B K N H Y T A S E E P L
 D C R A O K A I W W J P V T K
 C H E R U B I M D V H R A C D
 Z U C C I P F N O M Q E R S D
 F T I U R F A J H W O S E A T

ADAM
 AFRAID
 CHERUBIM
 CUNNING
 CURSED
 DIE

EAT
 EVE
 EVIL
 EYES
 FRUIT
 GARDEN

GOD
 GOOD
 HID
 OPENED
 SEED

SERPENT
 TREE OF LIFE
 TUNICS
 WISE
 WOMAN

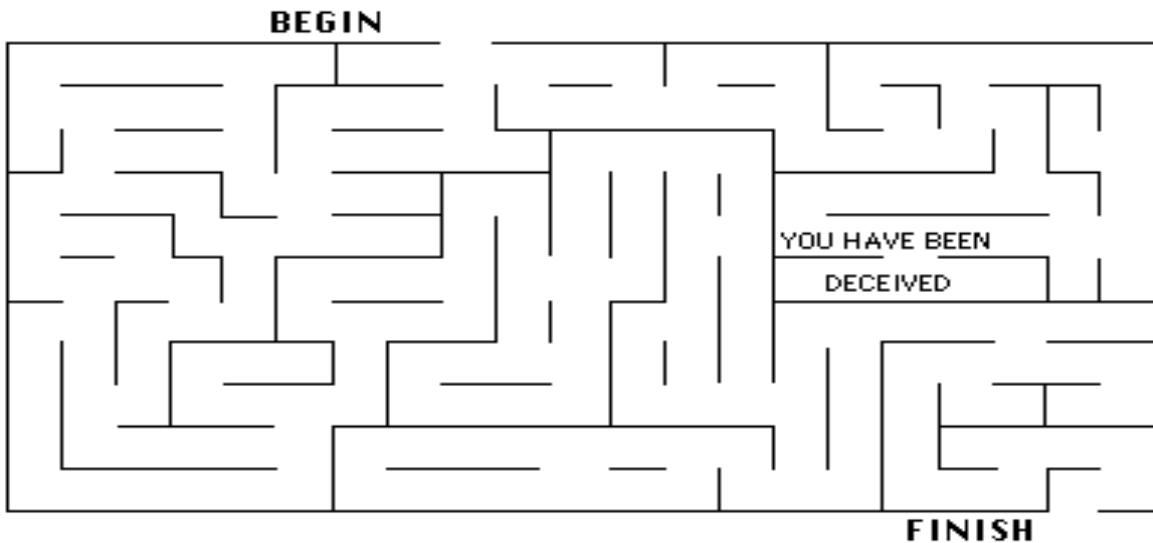

4. ADAM AND EVE ARE TEMPTED (GENESIS 3:1-4:1)

MEMORY VERSE:

"But I fear, lest somehow, as the serpent deceived Eve by his craftiness, so your minds may be corrupted from the simplicity that is in Christ." 2 CORINTHIANS 11:3

TRUE OR FALSE:

1. "Now the serpent was more cunning than any beast of the field which the LORD God had made. And he said to the woman, 'Has God indeed said, "You shall not eat of every tree of the garden?"' **GENESIS 3:1**

TRUE OR FALSE

2. "And the serpent said to the woman, 'You will surely not die.'" **GENESIS 3:4**

TRUE OR FALSE

FILL IN THE BLANKS:

3. "So when the woman saw that the tree was good for food, that it was pleasant to the _____, and a tree desirable to make one _____, she took of its fruit and ate..." **GENESIS**

3:6

TRUE OR FALSE:

4. ...She also gave to her husband with her, but he did not eat. **GENESIS 3:6**

TRUE OR FALSE

FILL IN THE BLANKS:

5. "And they heard the sound of the LORD God walking in the garden in the cool of the day, and Adam and his wife _____ themselves from the presence of the LORD God among the _____ of the garden." **GENESIS 3:8**

TRUE OR FALSE:

6. "Then the LORD God called to Adam and said to him, 'Where are you?' " **GENESIS 3:9**

TRUE OR FALSE

7. "Then the man said, 'The woman whom You gave to be with me, she gave me of the tree, and ate.'" **GENESIS 3:12**

TRUE OR FALSE

FILL IN THE BLANK:

8. "...And the woman said, 'The _____ deceived me, and I ate.'" **GENESIS 3:13**

TRUE OR FALSE

WRITE I FOR TRUE OR F FOR FALSE:

9. "So the LORD God said,..."

to the serpent... "You are cursed more than all cattle and every beast..." _____

(**GENESIS 3:17**)

to the woman... "I will greatly multiply your sorrow..." (**GENESIS 3:16**) _____

to Adam... "Blessed is the ground for your sake..." (**GENESIS 3:17**) _____

4. ADAM AND EVE ARE TEMPTED

(GENESIS 3:1-4:1)

G B L L P V M C U R F U T U Y R B F H L U T J P S K K P B U
 M K K O U I J D T E L A W O T D A Z N J W V H O J Q G B R N
 B K W Z T O T W O M Y D B L W C U B E B I S D L L Y P E Q E
 P O V M E N A K M D S D H G A R D E N B A E C T P C H C I S
 M J J S N H T I J E E W J O U G T D E K C T U P B Z K H J B
 W Q I D D I A R E Q H N Y U G S U B M J L K U N N A H M L T
 N W B F O U U D E N B T E I H Q N B J K E V E R S K C X J I
 G S W M R G E E B E O L K P B U I U Q U P N S A T A E I V L
 K P E Q A A N P G Y O A P I O M C Y V M A D I A R F A V R E
 B M L S Z F Q I H M I F G B V J S E E B I B Y P L R O M R I
 Y B V Q E F B Y G A R O L R S Q V E V Y S Y J L P V V T K A
 K B D V M T N B D S F A K I U L A J V R E Z G G H Z N Q J K
 P O D P D Q A B V V Y P T W F J E A L T R A A N L Y J V S Q
 U H Z B W D I E B Y B A G I B E I V A T P B K I Q E L U F Y
 Y S Z Q Q H Y P G K D D P G U T S K I C E U R N U H H I D R
 F S O J B A Q P C W F Y S T H R G U L M N E B N I Z D G Q B
 K R G I I U U Y C L B S O K U W F O R P T D N U C C R B V T
 T V W O T U Q F Z H E M T W Q K J Z U M E K Y C C S Z D B P
 G N H C O T T O H W E U W I T M P B U L Y G N Y M G B O R K
 E G Q T A D H J K W H R I U P L Z A C C A C M M R I Y N B Z
 Y D I C L T T W K Z T W U M A D A M Q N Q M Q T B F A Z I O
 G P L J B D T S R O L S H B L U F Z N A A N P F G L E F U V
 M K H W Z D R S E A U E J M I G B B R M O Q L H B B M N Q L
 Q S T Y Z Q R I N K W J D F J M B T U O Y R J D I K B B H C
 H P Y J N C W A C U Q M C O B C K P K W S U D R V M Z A C Y
 V P O T K U P G L N N G U E J V M Z B E E M D S S I U D C Y
 V R A N O J N I V U I O R P H U Z F Y S A E R M M U I P N P
 G B V A B K V W C D S V S K T B B E I G E S M C K B J U U D
 S O C S H E K A C L V S E J J N I V F E Q Z J U I W L K K D
 N S A L F S B F H U U P D F Y H Z F W Y U P L R R V M I S A

ADAM
 AFRAID
 CHERUBIM
 CUNNING
 CURSED
 DIE
 EAT
 EVE

EVIL
 EYES
 FRUIT
 GARDEN
 GOD
 GOOD
 HID

OPENED
 SEED
 SERPENT
 TREE OF LIFE
 TUNICS
 WISE
 WOMAN

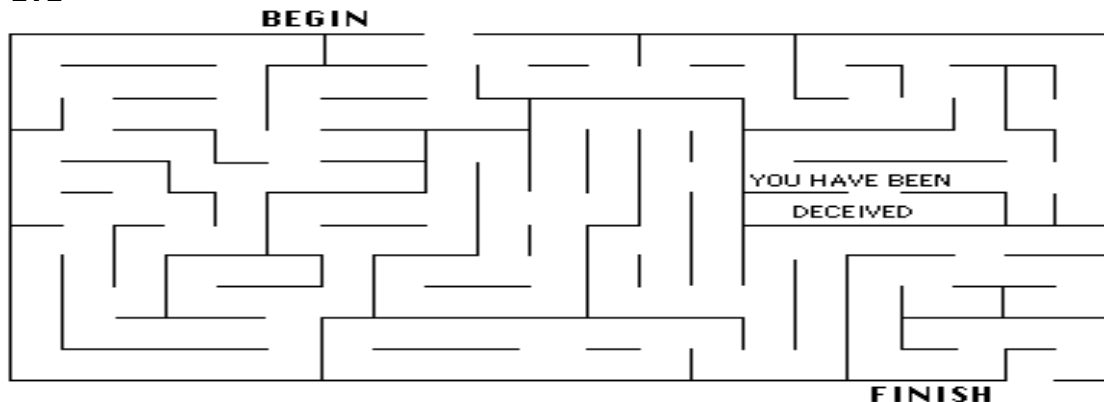

4. ADAM AND EVE ARE TEMPTED

(GENESIS 3:1-4:1)

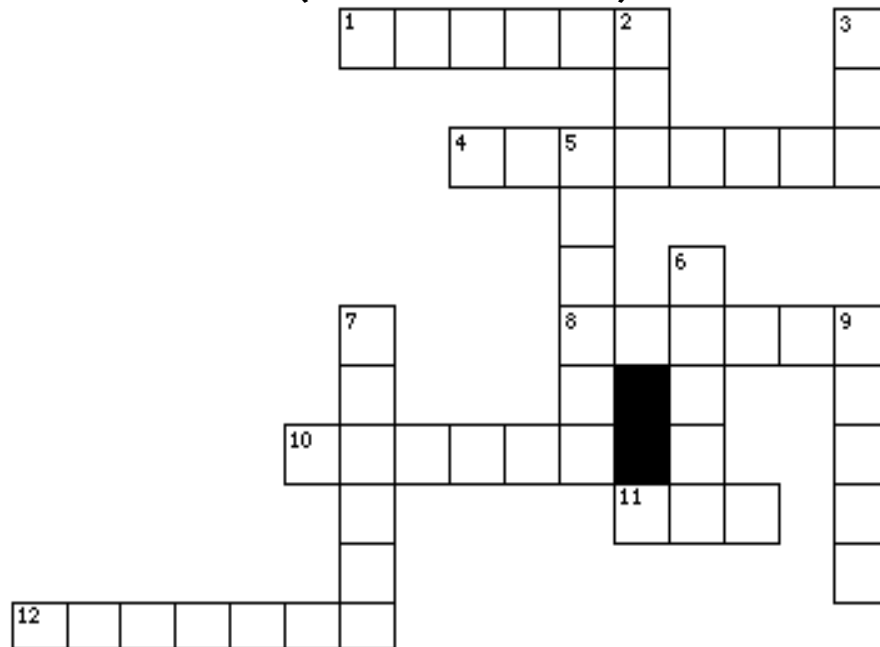

- 12 ACROSS "Now the _____ was more cunning than any beast of the field which the LORD God had made. And he said to the woman, 'Has God indeed said, 'You shall not eat of every tree of the garden?'" **GENESIS 3:1**
- 2 DOWN "And the serpent said, 'You will surely not ____.'" **GENESIS 3:4**
- 6 DOWN "So when the woman saw that the tree was good for food, that it was pleasant to the eye, and a tree desirable to make one wise, she took of its _____ and ate." **GENESIS 3:6**
- 11 ACROSS She also gave to her husband with her, and he _____. **GENESIS 3:6**
- 3 DOWN "And they heard the sound of the LORD God walking in the garden in the cool of the day, and Adam and his wife ____ themselves from the presence of the LORD God among the trees of the garden." **GENESIS 3:8**
- 1 ACROSS "Then the LORD God _____ to Adam and said to him, 'Where are you?' " **GENESIS 3:9**
- 9 DOWN "The man said, 'The _____ whom You gave to be with me, she gave me of the tree, and I ate.'" **GENESIS 3:12**
- 4 ACROSS "And the woman said, 'The serpent _____ me, and I ate.'" **GENESIS 3:13**
- "So the LORD God said,**
- 5 DOWN To the serpent... **GENESIS 3:14**
You are _____ more than all cattle and every beast
- 8 ACROSS To the woman... **GENESIS 3:16**
I will greatly multiply your _____
- 10 ACROSS To Adam... **GENESIS 3:17**
Cursed is the _____ for your sake
- 7 DOWN "But I fear, lest somehow, as the serpent deceived Eve by his craftiness, so your minds may be corrupted from the simplicity that is in____." **2 CORINTHIANS 11:3**

Bible Story 5

CAIN & ABEL

GENESIS 4:1-17

5. CAIN AND ABEL (GENESIS 4:1-17)

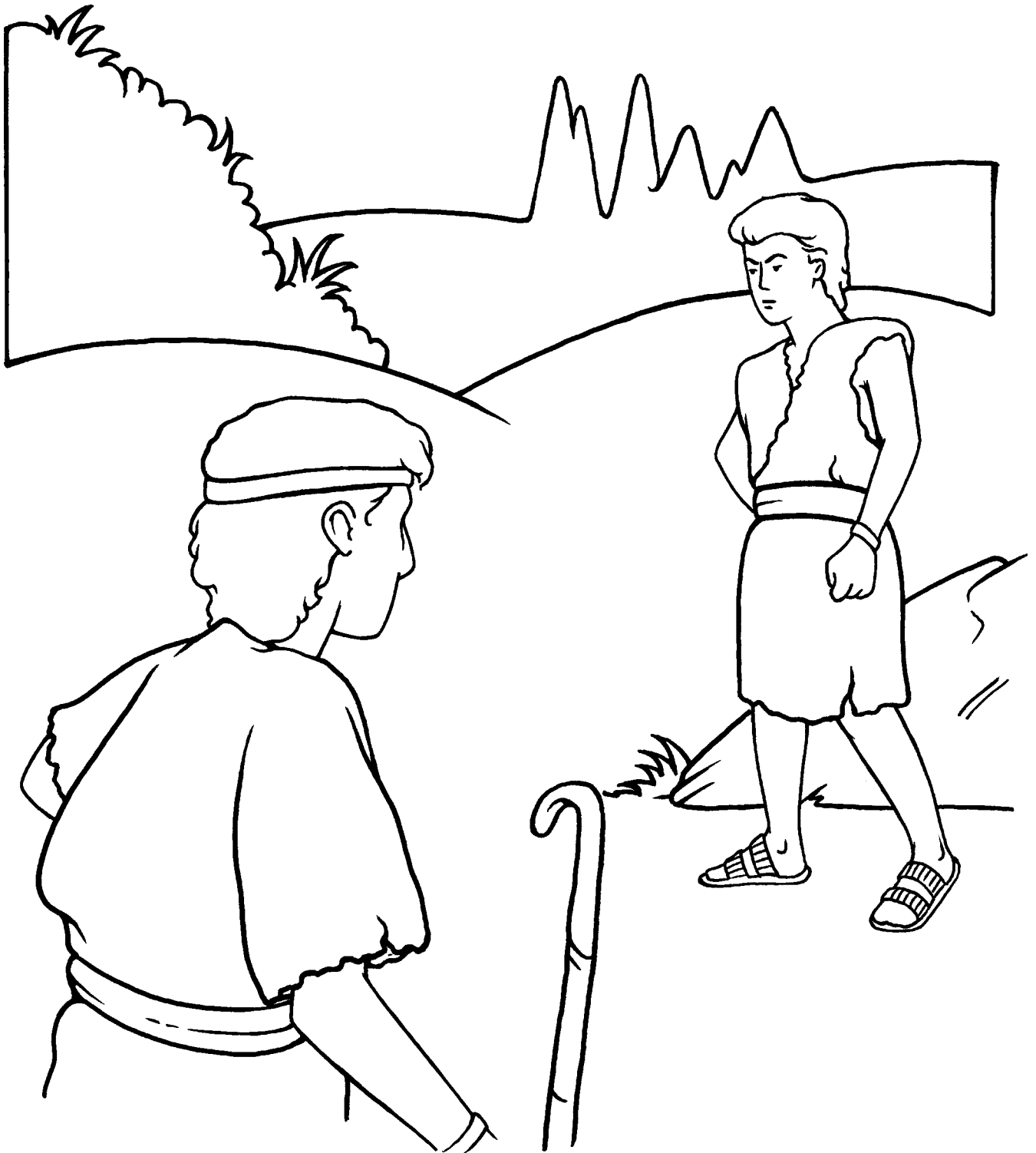

"Now Cain talked with Abel his brother; and it came to pass, when they were in the field, that Cain rose against Abel his brother and killed him."

GENESIS 4:8

5. CAIN AND ABEL (GENESIS 4:1-17)

MEMORY VERSE:

"If you do well, will you not be accepted? And if you do not do well, sin lies at the door. And its desire is for you, but you should rule over it." Genesis 4:7

FILL IN THE BLANKS:

1. "It came to pass that _____ brought an offering of the fruit of the ground to the LORD." **GENESIS 4:3**
2. "_____ also brought of the _____ of his flock and of their fat." **GENESIS 4:4**

CIRCLE THE CORRECT ANSWER:

3. Whose offering did the Lord respect? **GENESIS 4:4-5**
CAIN'S ABEL'S NO ONE'S
4. "So the LORD said to Cain, 'Why are you so (HAPPY, ANGRY)?'" **GENESIS 4:6**

TRUE OR FALSE:

5. "Now Cain talked with Abel his brother; and it came to pass, when they were in the field, that Cain rose against Abel his brother and killed him." **GENESIS 4:8**
TRUE OR FALSE
6. The LORD said to Cain, "What have you done? The voice of your _____ brother's blood cries out to Me from the ground." **GENESIS 4:10**
TRUE OR FALSE

FILL IN THE BLANK:

7. "So now you are _____ from the earth, which has opened its mouth to receive your brother's blood from your hand." **GENESIS 4:11**

CIRCLE THE CORRECT WORD:

8. "And Cain said to the LORD, 'My punishment is (GREATER, SMALLER) than I can bear!'" **GENESIS 4:13**

TRUE OR FALSE:

9. "Then Cain went out from the presence of the LORD and dwelt in the land of Nod on the east of Eden." **GENESIS 4:16**
TRUE OR FALSE

5. CAIN AND ABEL

(GENESIS 4:1-17)

P K M A R K R N F R A H I T L
 U H I Z X E T I E I B C L O Y
 N C Z L L H R S K L E C R P F
 I O X L L S P D E R L D E S R
 S V I U T E E Z E Q S N R K U
 H T Y B C S D F P I F E I Z I
 M N O T R M Q N E J H U E O T
 E R E U A X V X R T Q K V V Y
 N D C I D I U A O L V S E L P
 T J A J A V G R F J M U A C D
 P L E L M N B D S V R N K F D
 O F F E R I N G H R B E Q I A
 H D M M E A B P E R I S Y E W
 A N G R Y C D U E K U N R L Z
 K R X P C M O K P J Q T M D C

ABEL
 ADAM
 ANGRY
 BROTHERS
 CAIN
 CURSED

EVE
 FIELD
 FIRSTBORN
 FRUIT
 KEEPER OF SHEEP
 KILLED

LORD
 MARK
 OFFERING
 PUNISHMENT
 RESPECTED
 TILLER



5. CAIN AND ABEL (GENESIS 4:1-17)

MEMORY VERSE:

"If you do well, will you not be accepted? And if you do not do well, sin lies at the door. And its desire is for you, but you should rule over it." GENESIS 4:7

FILL IN THE BLANKS:

1. "It came to pass that _____ brought an offering of the fruit of the ground to the LORD." **GENESIS 4:3**
2. "_____ also brought of the _____ of his flock and of their fat." **GENESIS 4:4**
3. "And the LORD respected _____ and his offering." **GENESIS 4:4**
4. "But He did not respect _____ and his offering." **GENESIS 4:5**
5. "So the LORD said to Cain, 'Why are you so _____ ?' " **GENESIS 4:6**

TRUE OR FALSE:

6. "Now Cain talked with Abel his brother; and it came to pass, when they were in the field, that Cain rose against Abel his brother and killed him." **GENESIS 4:8**

TRUE OR FALSE

7. The LORD said to Cain, "What have you done? The voice of your brother's blood cries out to Me from the ground." **GENESIS 4:10**
- TRUE OR FALSE**

FILL IN THE BLANKS:

8. "So now you are _____ from the earth, which has opened its mouth to receive your brother's blood from your hand." **GENESIS 4:11**
9. "And Cain said to the LORD, 'My punishment is _____ than I can bear!' " **GENESIS 4:13**
10. "Then Cain went out from the _____ of the LORD and dwelt in the land of Nod on the east of Eden." **GENESIS 4:16**

5. CAIN AND ABEL (GENESIS 4:1-17)

Z F W A N U D U H C Y U C E W Y L L O T
 O M Y Z K A Q E T D F T Z M W H U A V W
 W Q E E K F N N T P U N I S H M E N T I
 H V S R K F C R R W O O H Q Z X W O S H
 E S A R O E U Q O K J M K D E L L I K J
 Q M J M E T E X R B W J K N O O Q A P D
 I Q T D B H J P W I T K R Y A I N P T U
 L V N W H Q T N E E S S E M K R I A W O
 H P A Q F H K O D R S G R A U F S D B L
 T B S X A I S A R E O H D I N Y V Y H O
 Y O L I F N E Y P B T F N E F X U S J U
 O Q F T V A G L N P I C S S S D U M Y I
 A J P F I U M R D I A G E H U R A U K I
 V I U A E U J Q Y Y G L C P E F U X P B
 C C T L L R T U K B O D V V S E D C G R
 A T N E O T I Q B R W F C Y D E P S K W
 L C B B N N A N D B R V C M L B R E G G
 O A D Z H T I T G U A B A K U E D J P T
 Z T I L L E R A I P F D H W F H W M S K
 M J R Z I D A T C P A G R L L T T G O W

ABEL
 ADAM
 ANGRY
 BROTHERS
 CAIN
 CURSED

EVE
 FIELD
 FIRSTBORN
 FRUIT
 KEEPER OF SHEEP
 KILLED

LORD
 MARK
 OFFERING
 PUNISHMENT
 RESPECTED
 TILLER



5. CAIN AND ABEL (GENESIS 4:1-17)

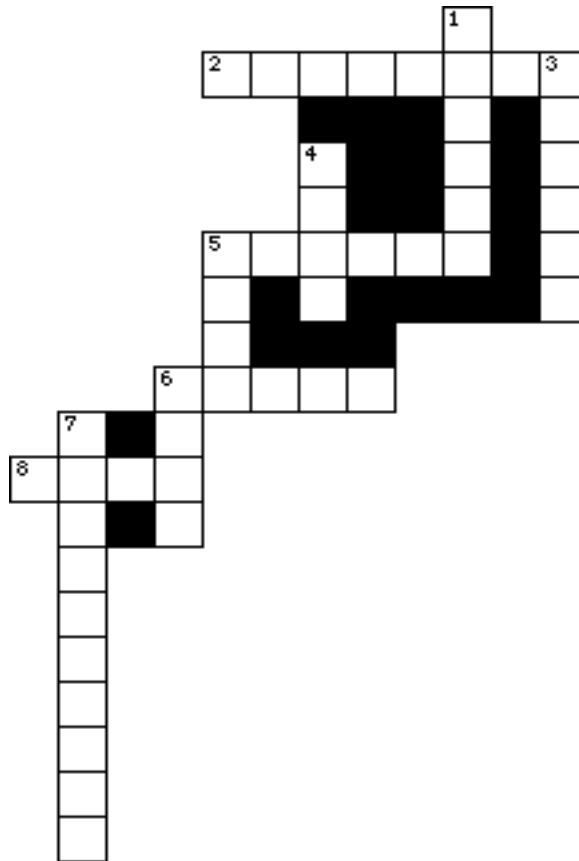

- 8 ACROSS *"If you do well, will you not be accepted? And if you do not do well, sin lies at the door. And its desire is for you, but you should _____ over it."* **GENESIS 4:7**
- 2 ACROSS "It came to pass that Cain brought an _____ of the fruit of the ground to the LORD." **GENESIS 4:3**
- 6 DOWN "_____ also brought of the firstlings of his flock and of their fat." **GENESIS 4:4**
- 5 DOWN "And _____ was very angry, and his countenance fell." **GENESIS 4:5**
- 6 ACROSS "So the LORD said to Cain, 'Why are you so _____?'" **GENESIS 4:6**
- 1 DOWN "Now Cain talked with Abel his brother; and it came to pass, when they were in the field, that Cain rose against Abel his brother and _____ him." **GENESIS 4:8**
- 3 DOWN The LORD said to Cain, "What have you done? The voice of your brother's blood cries out to Me from the _____." **GENESIS 4:10**
- 5 ACROSS "So now you are _____ from the earth, which has opened its mouth to receive your brother's blood from your hand." **GENESIS 4:11**
- 7 DOWN "And Cain said to the LORD, 'My _____ is greater than I can bear!'" **GENESIS 4:13**
- 4 DOWN "Then Cain went out from the presence of the _____ and dwelt in the land of Nod on the east of Eden." **GENESIS 4:16**

Bible Story 6

ENOCH

GENESIS 5:18-24

6. ENOCH
(GENESIS 5:18-24)



"And Enoch walked with God; and he was not, for God took him.."
GENESIS 5:24

6. ENOCH (GENESIS 5:18-24)

MEMORY VERSE:

"But without faith it is impossible to please Him, for he who comes to God must believe that He is, and that He is a rewarder of those who diligently seek Him." HEBREWS 11:6

CIRCLE THE CORRECT WORD:

1. "Jared lived one hundred and sixty-two years, and begot (ENOCH, EGGNOG)."
GENESIS 5:18

TRUE OR FALSE:

2. "Enoch lived sixty-five years, and begot Methuselah." GENESIS 5:21

TRUE OR FALSE

3. After he begot Methuselah, Enoch walked with God one hundred years, and begot sons and daughters. GENESIS 5:22

TRUE OR FALSE

CIRCLE THE CORRECT WORD:

4. "So all the days of Enoch were (ONE, THREE) hundred and sixty-five years."
GENESIS 5:23

FILL IN THE BLANKS:

5. "And Enoch _____ God; and he was not, for God took him.."
GENESIS 5:24

CIRCLE THE CORRECT WORDS:

6. "By (FAITH, FAINT) Enoch was translated so that he did not see death, 'and was not found because God had translated him', for before his translation he had this testimony, that he (PLEASED, DISPLEASED) God." HEBREWS 11:5

6. ENOCH

(GENESIS 5:18-24)

C	S	R	A	E	Y	U	G	B	A	M	A	S	Z	F
U	P	S	T	S	F	W	X	T	L	X	N	G	K	J
Q	P	T	D	J	K	J	G	O	D	I	M	D	K	T
D	W	A	Y	F	B	N	R	O	Q	E	V	E	Q	E
C	Q	D	E	K	L	A	W	K	F	T	R	E	J	J
N	T	Z	H	D	Y	S	Q	Q	H	Y	G	A	D	Z
N	A	S	O	F	N	Z	I	Y	P	L	F	P	J	Z
O	U	G	U	O	M	K	P	E	J	I	H	Z	B	K
A	N	O	S	D	N	A	R	G	T	A	E	R	G	C
H	U	D	Q	P	H	B	H	L	T	O	A	C	B	T
W	H	J	S	E	L	Z	Z	N	B	V	W	C	R	I
T	E	Q	S	O	D	F	I	V	H	C	O	N	E	O
M	E	T	H	U	S	E	L	A	H	Q	X	Q	B	T
I	R	I	I	O	R	H	V	Q	I	Z	P	I	K	A
W	J	K	L	C	E	N	V	T	A	U	E	W	E	N

ENOCH
 GOD
 GREAT-GRANDSON
 JARED
 LIVED

METHUSELAH
 NOAH
 TOOK
 WALKED
 YEARS

WRITE DOWN THE LETTERS AS YOU COME TO THEM ON THE LINES BELOW

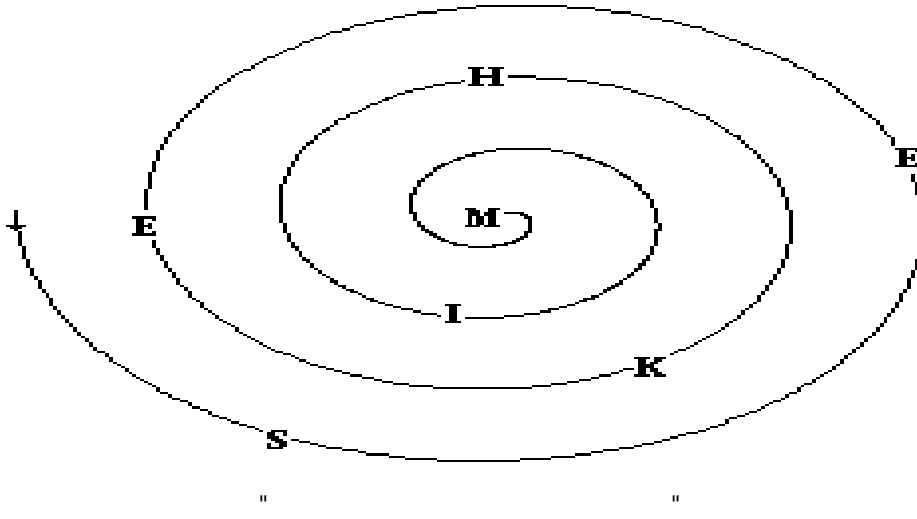

6. ENOCH

(GENESIS 5:18-24)

MEMORY VERSE:

"But without faith it is impossible to please Him, for he who comes to God must believe that He is, and that He is a rewarder of those who diligently seek Him." HEBREWS 11:6

FILL IN THE BLANK:

1. "Jared lived one hundred and sixty-two years, and begot _____."
GENESIS 5:18

TRUE OR FALSE:

2. "Enoch lived sixty-five years, and begot Methuselah." GENESIS 5:21

TRUE OR FALSE

3. After he begot Methuselah, Enoch walked with God one hundred years, and begot sons and daughters. GENESIS 5:22

TRUE OR FALSE

FILL IN THE BLANKS:

4. "So all the days of Enoch were _____ hundred and sixty-five years."
GENESIS 5:23

5. "And Enoch _____ God; and he was not, for God took him.."
GENESIS 5:24

6. "By _____ Enoch was translated so that he did not see death, 'and was not found because God had translated him', for before his translation he had this testimony, that he _____ God." HEBREWS 11:5

6. ENOCH

(GENESIS 5:18-24)

U Y S V X O J D K H T H P S D H Z R V M
 Y K N N W A I R O A A T I S V R O F U U
 Y P B K E V H A B M E T H U S E L A H X
 R U O G G C C C H U A T Y I B E A Y U S
 F O K D L R T Z O U U R B A G M K X A E
 T Y K P V A E E F N E R B G D E K L A W
 H F O K D L C A V T E W P W C Q U D D J
 E K J S D O J M T T N P P A Z N N F D M
 L T Q P Z Z W D I G Q N Y F S Y U B W G
 M G S P Z M Y W O D R K F R H M D G O D
 G J P R O F J Q N D X A A U P A L E T O
 M E A X W M T X H Q N E N T P S U H L V
 B Y M R H Q N I I C Y B O D R V F T A S
 P G B O E S A T H A O N D O S Y L L O P
 M M B S Q D S A U U A C E M E O Y U A T
 W Q O L I Q L L A J Y D V J N K N W P W
 N H H K L V P B F K Q W I K C W H Q A B
 G V S W H P U Z F S U K L G V L X N D H
 K V S V T B T Z T M Q I J H C W O I Y J
 B G R J Y Q N N Q J T E W G C W I S S Y

ENOCH
 GOD
 GREAT-GRANDSON
 JARED
 LIVED

METHUSELAH
 NOAH
 TOOK
 WALKED
 YEARS

WRITE DOWN THE LETTERS AS YOU COME TO THEM ON THE LINES BELOW

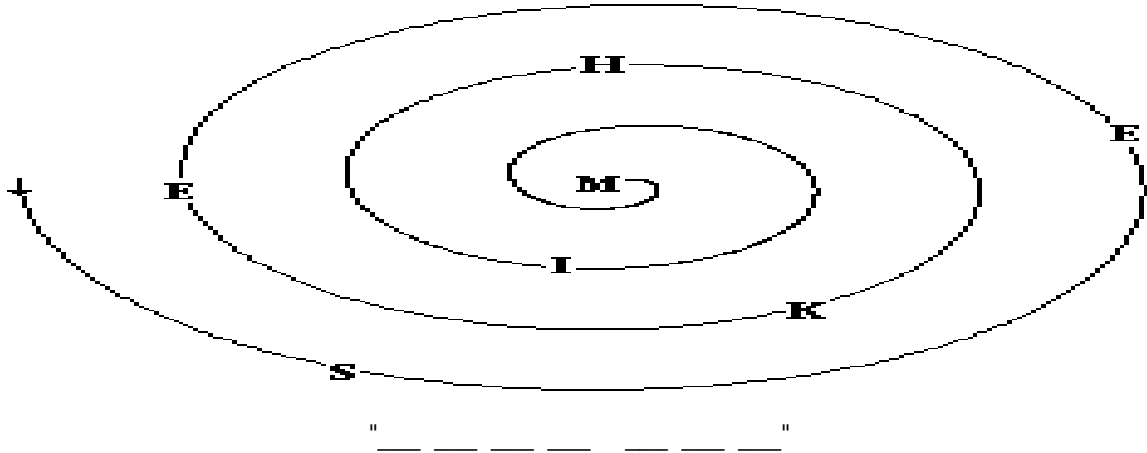

6. ENOCH (GENESIS 5:18-24)

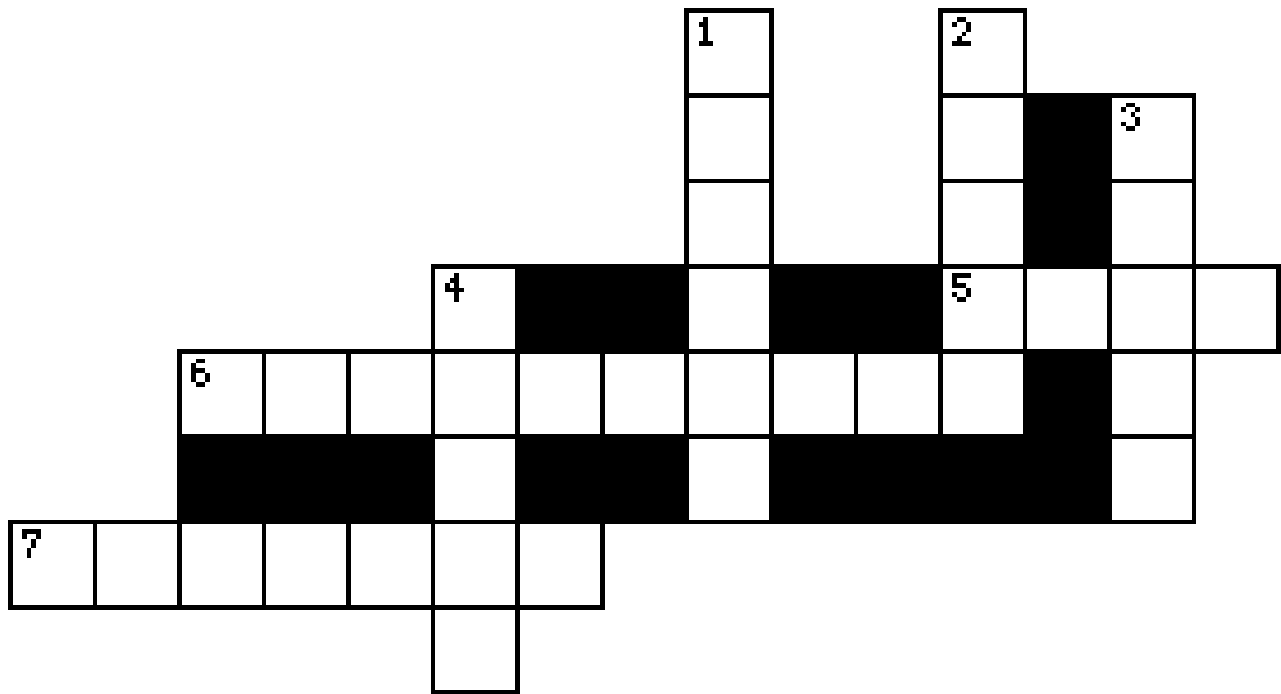

- 2 DOWN *"But without _____ it is impossible to please Him, for he who comes to God must believe that He is, and that He is a rewarder of those who diligently seek Him."*
HEBREWS 11:6
- 3 DOWN "Jared lived one hundred and sixty-two years, and begot _____." **GENESIS 5:18**
- 6 ACROSS "Enoch lived sixty-five years, and begot _____." **GENESIS 5:21**
- 1 DOWN "After he begot Methuselah, Enoch _____ with God three hundred years, and begot sons and daughters. **GENESIS 5:22**
- 4 DOWN "So all the days of Enoch were _____ hundred and sixty-five years." **GENESIS 5:23**
- 5 ACROSS "And Enoch walked with God; and he was not, for God _____ him.." **GENESIS 5:24**
- 7 ACROSS "By faith Enoch was translated so that he did not see death, 'and was not found because God had translated him', for before his translation he had this testimony, that he _____ God." **HEBREWS 11:5**

Bible Story 7

NOAH BUILDS THE ARK

GENESIS 5:28-6:22

7. NOAH BUILDS THE ARK

(GENESIS 5:28-6:22)

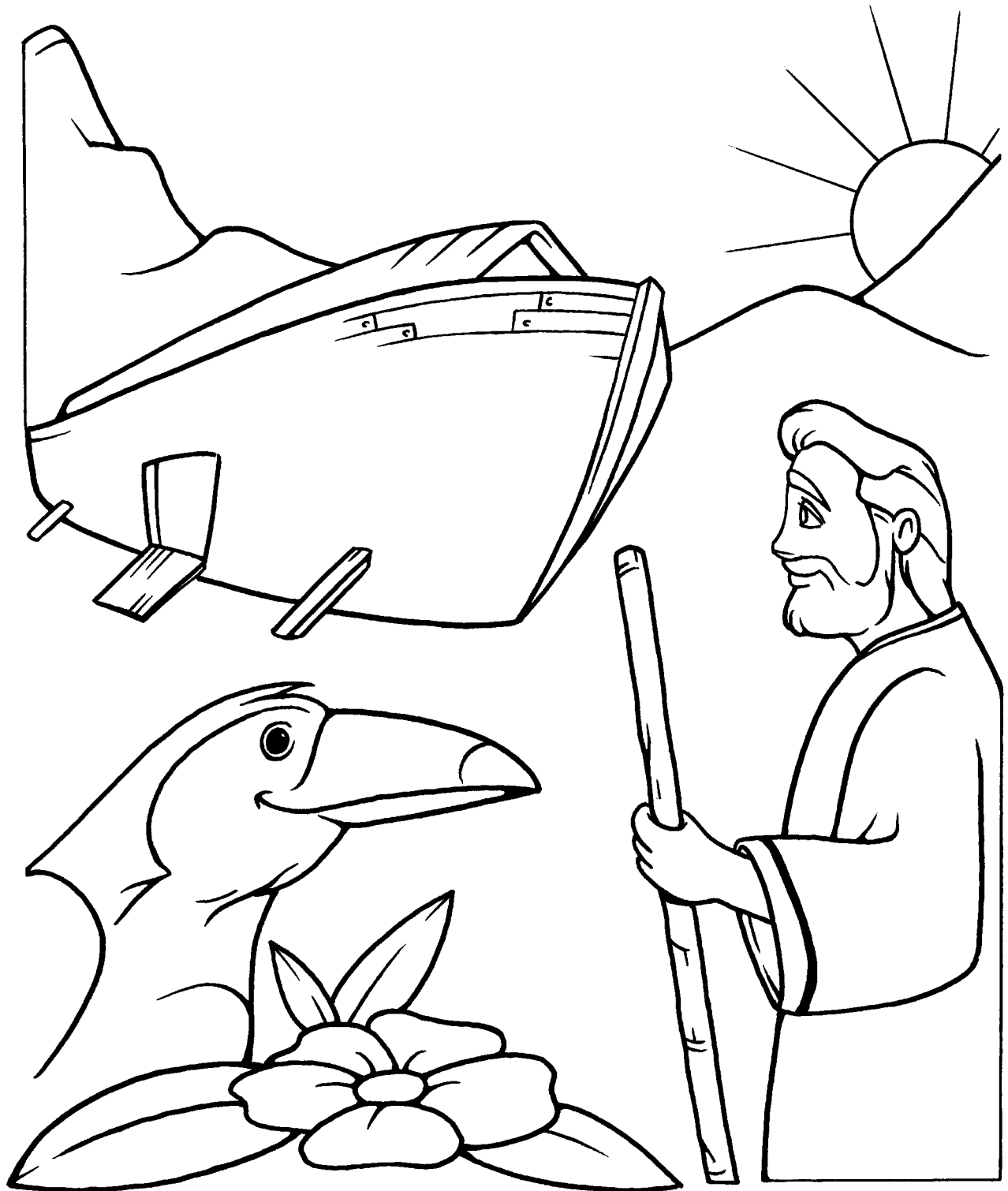

"By faith Noah, being divinely warned of things not yet seen, moved with godly fear, prepared an ark for the saving of his household."

HEBREWS 11:7

7. NOAH BUILDS THE ARK

(GENESIS 5:28-6:22)

MEMORY VERSE:

"By faith Noah, being divinely warned of things not yet seen, moved with godly fear, prepared an ark for the saving of his household." HEBREWS 11:7

CIRCLE THE CORRECT WORDS:

1. "Lamech lived one hundred and eighty-two years, and begot a son. And he called his name **(NOBE, NOAH)**, saying, 'This one will **(COMFORT, ANGER)** us concerning our work and the toil of our hands, because of the ground which the LORD has **(BLESSED, CURSED)**.' " **GENESIS 5:28-29**
2. "And Noah was **(FIVE, EIGHT)** hundred years old, and Noah begot Shem, Ham, and Japheth." **GENESIS 5:32**

TRUE OR FALSE:

3. "Then the LORD saw the wickedness of man was great in the earth, and that every intent of the thoughts of his heart was only evil continually." **GENESIS 6:5**
TRUE OR FALSE
4. And the LORD was happy that He had made man on the earth, and He was glad in His heart.
GENESIS 6:6
TRUE OR FALSE

FILL IN THE BLANKS:

5. "So the LORD said, 'I will _____ man whom I have created from the face of the earth, both man and beast, creeping thing and birds of the air, for I am _____ that I have made them.' " **GENESIS 6:7**

TRUE OR FALSE:

6. "But Noah found grace in the eyes of the LORD." **GENESIS 6:8**
TRUE OR FALSE

CIRCLE THE CORRECT WORDS:

7. The LORD said to Noah, ' Make yourself an ark of **(BEAVERWOOD, GOPHERWOOD)**; make rooms in the ark, and cover it inside and outside with **(PITCH, PAINT)**.' " **GENESIS 6:14**
8. "And behold, I Myself am bringing the flood waters on the **(OCEAN, EARTH)**, to destroy from under heaven all flesh in which is the breath of life." **GENESIS 6:17**
9. "But I will establish My covenant with you; and you shall go into the ark- you, your sons, your wife, and your sons' wives with you. And of every living thing of all flesh you shall bring **(TWO, FOUR)** of every sort into the ark, to keep them alive with you; they shall be male and female." **GENESIS 6:18-19**

7. NOAH BUILDS THE ARK

(GENESIS 5:28-6:22)

N P G G F O O D B G P O P O Q L L J L G
 W O D S F F Q X W I N D O W O L B D R Q
 D I Y A L I F U W Q D F W I H D R I D E
 S R V R K U R V Y W Q U J L A N E N O P
 C Y O E R H C Y O R T S E D M V O U H G
 N R O C S O G E U G J W H D E A O V Y G
 P E K O I D S Z K X I D A D H K W C Q L
 C X P R Q I O U Y C J N N S R K H G K M
 X V Z R S P O O K W I I F A V A C O E Y
 C T S U S K W E W M C V G U Y O J H H T
 X O T P O R D U A R X E I J M U S C G P
 P J V T E N J L H D E M E M X W T Q O V
 R C G U E H S H F I V H A L C I N A J E
 E Q O S Z E C I T C D N P J P K A E M N
 M L S M P N V E Q E D F L O O D I G N J
 H P W K F A H X M E H N G T G Y G A R L
 Y V D S E O Y Q D A I P B I R D S T M O
 Y G K Y U I R B X P L B A B J Y S N I R
 M Y A X V P G T H L M A W J N E R B F D
 B Q L I V E M V M O O S K V B H V K J A

- | | | | |
|-----------|------------|-----------|------------|
| ANIMALS | EVIL | GRIEVED | PITCH |
| ARK | FLOOD | HAM | SHEM |
| BIRDS | FOOD | JAPHETH | SORRY |
| COMFORT | GIANTS | LAMECH | WICKEDNESS |
| COMMANDED | GOD | LORD | WINDOW |
| CORRUPT | GOPHERWOOD | NOAHWIVES | DESTROY |

HELP THESE PENGUINS FIND THEIR WAY TO THE ARK



7. NOAH BUILDS THE ARK

(GENESIS 5:28-6:22)

MEMORY VERSE:

"By faith Noah, being divinely warned of things not yet seen, moved with godly fear, prepared an ark for the saving of his household, by which he condemned the world and became heir of the righteousness which is according to faith." HEBREWS 11:7

FILL IN THE BLANKS:

1. "Lamech lived one hundred and eighty-two years, and begot a son. And he called his name _____, saying, 'This one will _____ us concerning our work and the toil of our hands, because of the ground which the LORD has _____.'" **GENESIS 5:28-29**
2. "And Noah was five hundred years old, and Noah begot _____, _____, and _____." **GENESIS 5:32**

TRUE OR FALSE:

3. "Then the LORD saw the wickedness of man was great in the earth, and that every intent of the thoughts of his heart was only evil continually." **GENESIS 6:5**
TRUE OR FALSE
4. And the LORD was happy that He had made man on the earth, and He was glad in His heart.
GENESIS 6:6
TRUE OR FALSE

FILL IN THE BLANKS:

5. "So the LORD said, 'I will _____ man whom I have created from the face of the earth, both man and beast, creeping thing and birds of the air, for I am _____ that I have made them.'" **GENESIS 6:7**

TRUE OR FALSE:

6. "But Noah found grace in the eyes of the LORD." **GENESIS 6:8**
TRUE OR FALSE

CIRCLE THE CORRECT WORDS:

7. The LORD said to Noah, ' Make yourself an ark of (**BEAVERWOOD, GOPHERWOOD**); make rooms in the ark, and cover it inside and outside with (**PITCH, PAINT**).'" **GENESIS 6:14**

FILL IN THE BLANKS:

8. "And behold, I Myself am bringing the _____ _____ on the earth, to _____ from under heaven all flesh in which is the breath of life." **GENESIS 6:17**
9. "But I will establish My _____ with you; and you shall go into the ark- you, your sons, your wife, and your sons' wives with you. And of every living thing of all flesh you shall bring _____ of every sort into the ark, to keep them alive with you; they shall be male and _____ female." **GENESIS 6:18-19**

7. NOAH BUILDS THE ARK

(GENESIS 5:28-6:22)

P A A O C T S K K Y L B B U Q G A E L C K S M P M I I D C C
R V S B U R S K W X A H R X L J V E J L N Z J B K U J P C Y
X C L H J R I R L D O J W H J P K M B P B P L N I X L U N Y
O A P F D W A E W D B Y G C O M F O R T Y J P S R W M K U P
S L U O K P G N W I E K T U T Z J J B A Z H O L K V P I K D
L O O H S N G O R F A V K Q W F A Q K I A D L P Q K X X S D
K L T V C K W D P B P P E T K B P V J E S E V I W G E R U A
F Z N I M T S C Z H A G W I M X H E K Y X C T H Y R R O S W
W M D O J B I V O E E K I P R K E V U A U Y O R T S E D N Z
V F R N T C A P A H D R U L L G T V M Q E U P L Y P C Q E C
J M A H A D F C K T Y G W J U M H L X A C U N Q C H H I S P
X Q Z I A W U C U L S P M O G Z U A Y O O S R T Z K M J X Y
W S H A M K T H N U M S W B O X O I R Y M Y A P A H X L T E
E Q E U U S H E M W U O F O C D Z L T E M J P U K C I J I J
L V M A E I O D U Q X T O J D I X R T A A G L R R O V V L R
V P D F N E M R D N S W E H V N A U C E N A Y R V V M R E L
D B L F Q P J O W I E I P T U Z I U M Q D K M O Z N T R I P
D Q W A X I K L L I J H K J B F M W P U E R T C Y J Q K A P
Z J Q T M Y G R U S C J J Y N Z Z C M T D B F U E L V J K B
Z I X Q N E H E F V M K F R H X B Q L V D N H I H D U S Q X
O C I H A B C M L U G D E S T N A I G S K Y D C Z R G F Y D
W T T A Y B G H A U O D Y D X D T N C L G N R C C Z B Q R T
H C A U Q P A Q Y R O U T D N K P R S A C M S M S X D V X P
Q J L U U O D N H G K O W C A E Z U G M M Q M R G Y O X T G
I W B T N P V Y D A V L U G U X S K E I N P C X I A N R P B
L Y Z T Q Y B M X O S O G S V U F S Y N Q L U G F E Z B K A
H J Z D T F G A O D O U H Q A Y V B U A R J R B L M F I Z V
T E V I L O C S I D P F X U E E F I W S U D S I B X N U O F
Y T N D H J Z V R W T I V M I E H F I E M D J V K Z X Q V R
O N K Q T W H Y F T W I S J S J N W A T E R L S M U A H L F

- | | | | | |
|------------|------------|---------|--------|---------|
| ANIMALS | EVIL | GRIEVED | PITCH | ARK |
| FLOOD | HAM | SHEM | BIRDS | FOOD |
| JAPHETH | SORRY | COMFORT | GIANTS | LAMECH |
| WICKEDNESS | COMMANDED | GOD | LORD | WINDOW |
| CORRUPT | GOPHERWOOD | NOAH | WIVES | DESTROY |

HELP THESE PENGUINS FIND THEIR WAY TO THE ARK



7. NOAH BUILDS THE ARK

(GENESIS 5:28-6:22)

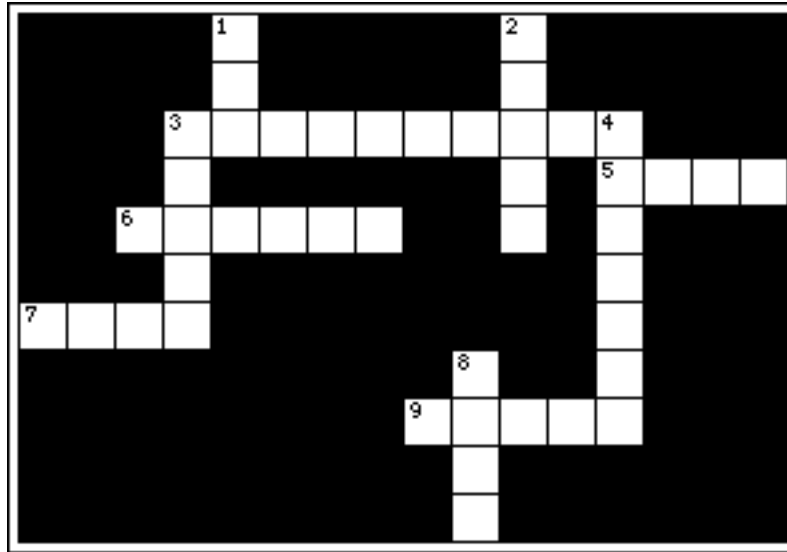

- 6 ACROSS "By faith Noah, being divinely warned of things not yet seen, moved with godly fear, prepared an ark for the _____ of his household." **HEBREWS 11:7**
- 8 DOWN "Lamech lived one hundred and eighty-two years, and begot a son. And he called his name _____, saying, 'This one will comfort us concerning our work and the toil of our hands, because of the ground which the LORD has cursed.'" **GENESIS 5:28-29**
- 7 ACROSS "And Noah was _____ hundred years old, and Noah begot Shem, Ham, and Japheth." **GENESIS 5:32**
- 5 ACROSS "Then the LORD saw the wickedness of man was great in the earth, and that every intent of the thoughts of his heart was only _____ continually." **GENESIS 6:5**
- 9 ACROSS "And the LORD was _____ that He had made man on the earth, and He was grieved in His heart." **GENESIS 6:6**
- 4 DOWN "So the LORD said, 'I will _____ man whom I have created from the face of the earth, both man and beast, creeping thing and birds of the air, for I am sorry that I have made them.'" **GENESIS 6:7**
- 3 DOWN "But Noah found _____ in the eyes of the LORD." **GENESIS 6:8**
- 3 ACROSS The LORD said to Noah, ' Make yourself an ark of _____; make rooms in the ark, and cover it inside and outside with pitch." **GENESIS 6:14**
- 2 DOWN "And behold, I Myself am bringing the _____ waters on the earth, to destroy from under heaven all flesh in which is the breath of life." **GENESIS 6:17**
- 1 DOWN "But I will establish My covenant with you; and you shall go into the ark- you, your sons, your wife, and your sons' wives with you. And of every living thing of all flesh you shall bring _____ of every sort into the ark, to keep them alive with you; they shall be male and female." **GENESIS 6:18-19**

Bible Story 8

**GOD SENDS
A GREAT FLOOD**

GENESIS 7:1-8:19

8. GOD SENDS A GREAT FLOOD (GENESIS 7:1-8:19)

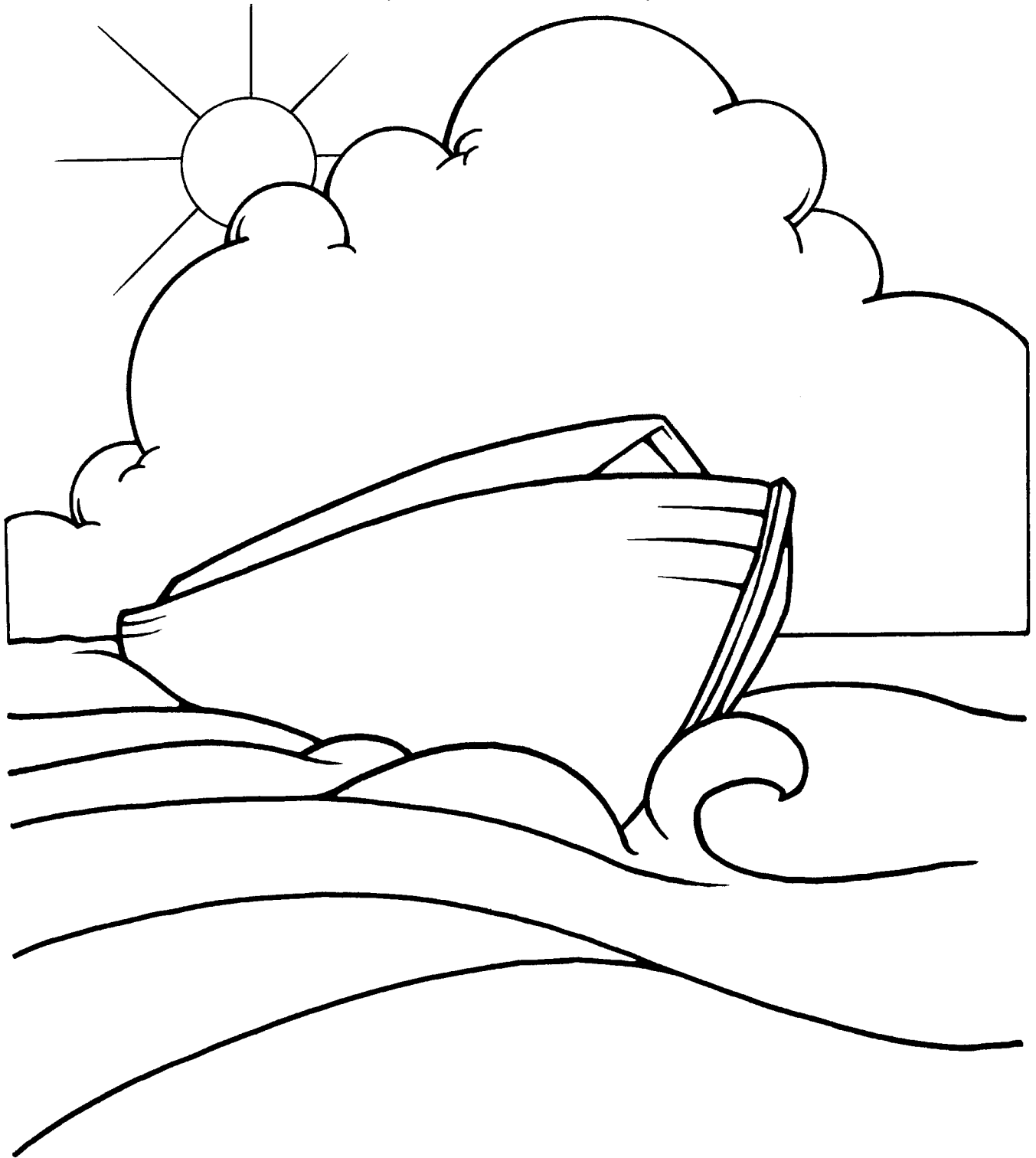

"Now the flood was on the earth forty days. The waters increased and lifted up the ark, and it rose high above the earth."

GENESIS 7:17

8. GOD SENDS A GREAT FLOOD (GENESIS 7:1-8:19)

MEMORY VERSE:

"The Lord is not slack concerning His promise, as some count slackness, but is longsuffering toward us, not willing that any should perish but that all should come to repentance." 2 PETER 3:9

TRUE OR FALSE:

1. "The LORD said to Noah, 'Come into the ark, you and all your household, because I have seen that you are righteous before Me in this generation.' " **GENESIS 7:1**
TRUE OR FALSE

UNDERLINE THE CORRECT ANSWER:

2. The LORD said, 'You shall take with you...' " **GENESIS 7:2-3**
a. seven each of every clean animal, a male and his female
b. two each of animals that are unclean, a male and his female
c. seven each of birds of the air, male and female
d. all of the above

TRUE OR FALSE:

3. "And Noah did according to all that the LORD commanded him." **GENESIS 7:5**
TRUE OR FALSE

CIRCLE THE CORRECT WORDS:

4. "So Noah, with his sons, his wife, and his sons' wives, went into the ark because of the waters of the **(RIVERS, FLOOD)**. Of the clean beasts, of beasts that are unclean, of birds, and of everything that creeps on the earth, **(TWO BY TWO, THREE BY THREE)** they went into the ark to Noah, male and female, as God had commanded Noah." **GENESIS 7:7-9**

TRUE OR FALSE:

5. "So those that entered, male and female of all flesh, went in as God had commanded him; and the LORD shut him in." **GENESIS 7:16**
TRUE OR FALSE
6. "Now the flood was on the earth forty days. The waters increased and lifted up the ark, and it rose high above the earth." **GENESIS 7:17**
TRUE OR FALSE

FILL IN THE BLANKS:

7. "And the waters prevailed exceedingly on the earth, and all the high hills under the whole heaven were _____." **GENESIS 7:19**
8. "_____ in whose nostrils was the breath of the spirit of life, _____ that was on dry land, _____."
GENESIS 7:22

CIRCLE THE CORRECT WORDS:

9. "And the waters prevailed on the earth one hundred and fifty days. Then God **(FORGOT, REMEMBERED)** Noah, and every living thing, and all the animals that were in the ark. And God made a wind to pass over the earth, and the waters subsided. **GENESIS 7:24-8:1**
10. "God spoke to Noah, saying, '**(GO OUT OF, STAY IN)** the ark, you and your wife, and your sons' wives with you.' " **GENESIS 8:15-16**

8. GOD SENDS A GREAT FLOOD

(GENESIS 7:1-8:19)

R C L E A N K A D T T K X L V
 I R A I N X V R R O N E V E S
 G S H H A O N K L A O D T S L
 H O D R A V E N C L R L L Y A
 T N F A E L E V I L O A F A M
 E S S E V I W F Y V J A T D I
 O K F T N T W I N D O W S Y N
 U O W E L O E G E V O D A T A
 S S T H G I N Y T R O F B R U
 U O Y F M O W T Y B O W T O V
 A P S N I A T N U O F L H F P
 U R E S T E D S D P I Y O R I
 R E M E M B E R E D P S P R R
 T F S Y A N S D R I B G U R D
 E D K R H C A E O W T M V E F

ANIMALS
 ARARAT
 ARK
 BIRDS
 CLEAN
 DOVE

FLOOD
 FORTY DAYS
 FORTY NIGHTS
 FOUNTAINS
 LORD
 NOAH

OLIVE LEAF
 RAIN
 RAVEN
 REMEMBERED
 RESTED
 RIGHTEOUS

SEVEN
 SONS
 TWO BY TWO
 TWO EACH
 WINDOWS
 WIVES

WRITE DOWN THE LETTERS IN THE BOXES AS YOU COME TO THEM ON THE LINES BELOW

→		A				E		T				A
	L		L					R	O		N	
				M			E		C			T
		S			O		D		E			
			O			C			P		N	
	H				U		L			E		

8. GOD SENDS A GREAT FLOOD

(GENESIS 7:1-8:19)

MEMORY VERSE:

"The Lord is not slack concerning His promise, as some count slackness, but is longsuffering toward us, not willing that any should perish but that all should come to repentance." 2 PETER 3:9

FILL IN THE BLANK:

1. "The LORD said to Noah, 'Come into the ark, you and all your household, because I have seen that you are _____ before Me in this generation.'" GENESIS 7:1

UNDERLINE THE CORRECT ANSWER:

2. The LORD said, 'You shall take with you...' " GENESIS 7:2-3
- a. seven each of every clean animal, a male and his female
 - b. two each of animals that are unclean, a male and his female
 - c. seven each of birds of the air, male and female
 - d. all of the above

TRUE OR FALSE:

3. "And Noah did according to all that the LORD commanded him." GENESIS 7:5
TRUE OR FALSE

FILL IN THE BLANKS:

4. "So Noah, with his sons, his wife, and his sons' wives, went into the ark because of the waters of the _____. Of the clean beasts, of beasts that are unclean, of birds, and of everything that creeps on the earth, _____ they went into the ark to Noah, male and female, as God had commanded Noah." GENESIS 7:7-9

TRUE OR FALSE:

5. "So those that entered, male and female of all flesh, went in as God had commanded him; and the LORD shut him in." GENESIS 7:16
TRUE OR FALSE

FILL IN THE BLANKS:

6. "Now the flood was on the earth _____ days. The waters increased and lifted up the ark, and it rose high above the earth." GENESIS 7:17
7. "And the waters prevailed exceedingly on the earth, and all the high hills under the whole heaven were _____." GENESIS 7:19
8. "_____ in whose nostrils was the breath of the spirit of life, _____ that was on dry land, _____." GENESIS 7:22
9. "And the waters prevailed on the earth one hundred and fifty days. Then God _____ Noah, and every living thing, and all the animals that were in the ark. And God made a wind to pass over the earth, and the waters subsided. GENESIS 7:24-8:1
10. "God spoke to Noah, saying, '_____ the ark, you and your wife, and your sons' wives with you.'" GENESIS 8:15-16

8. GOD SENDS A GREAT FLOOD

(GENESIS 7:1-8:19)

A S K F J P S A H M V K R T U X U A Q B S Q R F G A V Q L I
M G S N I A T N U O F D R W L X V Y X Y F F N D S B K H Y S
X D C V H Y Z C Z F A A Y L P G Z U Q K J H K R A H R U J C
T E T X G B F W Y S I D Y A M E A T F K S W Y H L P W N H T
Y P I S E D P J N N R O D P C I U W G F G U M D C U Y H W E
L Z O V U R G U J W L K J P C K E O A J A I Z F Y V B P Z K
I C R A V E N K T U W Q I A V X F B M M R E U W D L G U A E
O C T M W C K O P D J K P X Z P P Y M V A K L Y T R P Y P O
V Q A A S U O E T H G I R V K P T T A W S E I E L R F N X E
Q I N Z D G B I L S U L T Q F U O W O Z F Y K S V E Q M I N
Z W R S W R U T J J O W V D K Z N O K F N B N K V I K H C S
U Z P H W I K E C H E K R V S V I H C I T I M T P V L B N M
A K I M Y D N J V R P I F S M F J A Y Z Q R C E T U G O Z J
A K Q X R G C D T Q E J E M O F J E U T C D D F J V X Y F D
N Q D O P N U K O O T S J C A R O C D M D S N Y I P Q A N H
I J L S Z G M K W W C S T Z T K Y R Y G Y B Y R P I L O F R
M B D E R E R E B M E M E R O E M K T N T G R T J N K R J M P T
A B J V S Z D P H E S U U L D Y H A G Y Q I D L D F V B G K
L R Q O W E L Z H A O N G U Z R G I T R N O V M D V U H G R
S B R J B J V Y P W C E F T J G F Z I H T I C A W O X N Z X
N K I J M P S E J E H A K M S I Y S I U B W G X A I V X A W
M E L E W N V Y N B H V D O M C Q N P V K A U H Y Q V E B U
G F S A U U R O H E U C B E L K D C G Y N E A T T X E E K E
F J T W F O C J Q K A D A E X U C Z C A I P U O S S A V S E
H F O R T Y D A Y S E C A E P A M X E Y J Q T N G I F I O O
A T F L I F M F O S N N H M O V P L J R E T E D O O L F M Z
W E A Z X L L A A U C O K X C W C R N T F F K K M P I U Y N
X J Y X G L B H W H N Q S N D N T P H E S V O V X O M S S K
P Z Y T A R A R A P Q E K O U X O J E U A I O E T R I S G K
E Z O P Y M X A V E L N A B T O E P D S G F P F L A O A U J

ANIMALS
ARARAT
ARK
BIRDS
CLEAN
DOVE
FLOOD

FORTY DAYS
FORTY NIGHTS
FOUNTAINS
LORD
NOAH
OLIVE LEAF

RAIN
RAVEN
REMEMBERED
RESTED
RIGHTEOUS
SEVEN EACH

SONS
TWO BY TWO
TWO EACH
UNCLEAN
WINDOW
WIVES

WRITE DOWN THE LETTERS IN THE BOXES AS YOU COME TO THEM ON THE LINES BELOW

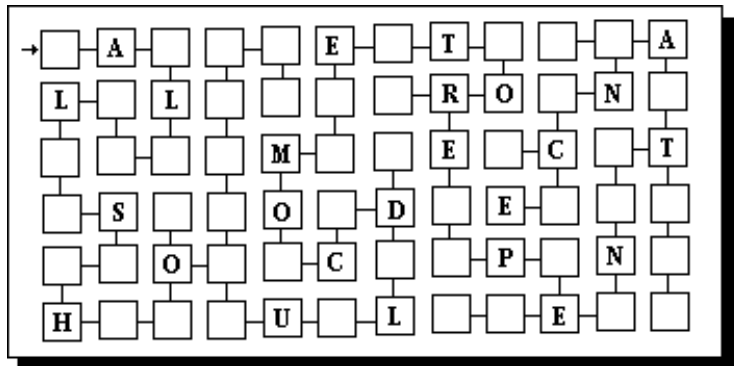

8. GOD SENDS A GREAT FLOOD

(GENESIS 7:1-8:19)

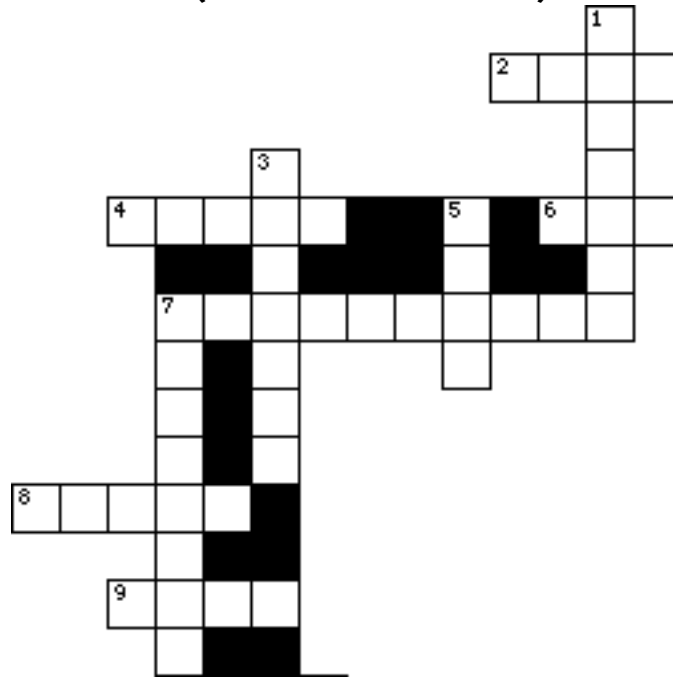

- 3 DOWN "The Lord is not slack concerning His _____ as some count slackness, but is longsuffering toward us, not willing that any should perish but that all should come to repentance." **2 PETER 3:9**
- 7 DOWN "The LORD said to Noah, 'Come into the ark, you and all your household, because I have seen that you are _____ before Me in this generation.'" **GENESIS 7:1**
- 4 ACROSS The LORD said, "You shall take with you seven each of _____ clean animal, a male and his female." **GENESIS 7:2**
- 9 ACROSS "And _____ did according to all that the LORD commanded him." **GENESIS 7:5**
- 6 ACROSS "So Noah, with his sons, his wife, and his sons' wives, went into the _____ because of the waters of the flood." **GENESIS 7:7**
- 10 ACROSS "So those that entered, male and female of all flesh, went in as God had commanded him; and the LORD _____ him in." **GENESIS 7:16**
- 8 ACROSS "Now the flood was on the earth _____ days. The waters increased and lifted up the ark, and it rose high above the earth." **GENESIS 7:17**
- 1 DOWN "And the waters prevailed exceedingly on the earth, and all the high hills under the whole heaven were _____." **GENESIS 7:19**
- 5 DOWN "All in whose nostrils was the breath of the spirit of life, all that was on dry land, _____." **GENESIS 7:22**
- 7 ACROSS "And the waters prevailed on the earth one hundred and fifty days. Then God _____ Noah, and every living thing, and all the animals that were in the ark. And God made a wind to pass over the earth, and the waters subsided. **GENESIS 7:24-8:1**
- 2 ACROSS "God _____ to Noah, saying, 'Go out of the ark, you and your wife, and your sons' wives with you.'" **GENESIS 8:15-16**

Bible Story 9

GOD'S COVENANT

GENESIS 8:20-9:17

9. GOD'S COVENANT (GENESIS 8:20-9:17)



"The rainbow shall be in the cloud, and I will look on it to remember the everlasting covenant between God and every living creature of all flesh that is on the earth."

GENESIS 9:16

9. GOD'S COVENANT (GENESIS 8:20-9:17)

MEMORY VERSE:

"The rainbow shall be in the cloud, and I will look on it to remember the everlasting covenant between God and every living creature of all flesh that is on the earth."
GENESIS 9:16

CIRCLE THE CORRECT WORDS:

1. "Noah built an (**ALTAR, ANOTHER ARK**) to the LORD, and took of every clean animal and of every clean bird, and offered burnt offerings on the (**ALTAR, ARK**)." GENESIS 8:20
2. "And the LORD (**HEARD, SMELLED**) a soothing aroma. Then the LORD said in His (**HEART, HEAD**), 'I will never again curse the ground for man's sake.' " GENESIS 8:21

TRUE OR FALSE:

3. "So God blessed Noah and his sons, and said to them: 'Be fruitful and multiply, and fill the earth.' " GENESIS 9:1
TRUE OR FALSE
4. "Then God spoke to Noah and to his sons with him, saying: 'And as for Me, behold, I establish My covenant with you and with your descendants after you.' " GENESIS 9:8-9
TRUE OR FALSE
5. "Thus I establish My covenant with you: Never again shall all flesh be cut off by the waters of the flood; never again shall there be a flood to destroy the earth." GENESIS 9:11
TRUE OR FALSE

CIRCLE THE CORRECT WORDS:

6. God said, "I set My (**RAIN, RAINBOW**) in the cloud, and it shall be for the sign of the covenant between Me and the earth." GENESIS 9:13

FILL IN THE BLANK:

7. "The rainbow shall be in the cloud, and I will look on it to remember the everlasting covenant between _____ and every living creature of all flesh that is on the earth." GENESIS 9:16

9. GOD'S COVENANT

(GENESIS 8:20-9:17)

P W K S O N S J V V Q W J D N
V D I S N R A R O M A D J I B
G K Q O U E F V E B X I C M A
Y A A O V S G N I R E F F O S
Q H S E N R E M E M B E R O P
D G H Z C I R H Z W H C X O D
O S S P F O A Y U Y M P V U W
O A I F I N V G U U G L O F D
K U L L U A C E A K Q L D U R
P K B O H G O D N R C O E D O
Z S A O I I G G I A E P S I L
S Y T D P P O M X Y N V S V S
T X S R A I N B O W W T E E I
V F E E K Q W X Q H G D L N G
G L R A T L A U B F X Q B M N

ALTAR
GOD
REMEMBER
COVENANT

FLOOD
RAINBOW
CLOUD
NOAH

OFFERINGS
BLESSED
NEVER AGAIN
SONS

AROMA
LORD
SIGN
ESTABLISH



9. GOD'S COVENANT (GENESIS 8:20-9:17)

MEMORY VERSE:

"The rainbow shall be in the cloud, and I will look on it to remember the everlasting covenant between God and every living creature of all flesh that is on the earth."

GENESIS 9:16

FILL IN THE BLANKS:

1. "Noah built an _____ to the LORD, and took of every clean animal and of every clean bird, and offered burnt _____ on the altar." **GENESIS 8:20**
2. "And the LORD _____ a soothing aroma. Then the LORD said in His _____, 'I will never again curse the ground for man's sake.'" **GENESIS 8:21**

TRUE OR FALSE:

3. "So God blessed Noah and his sons, and said to them: 'Be fruitful and multiply, and fill the earth.'" **GENESIS 9:1**
TRUE OR FALSE
4. "Then God spoke to Noah and to his sons with him, saying: 'And as for Me, behold, I establish My covenant with you and with your descendants after you.'" **GENESIS 9:8-9**
TRUE OR FALSE

FILL IN THE BLANKS:

5. "Thus I establish My _____ with you: Never again shall all flesh be cut off by the waters of the flood; never again shall there be a _____ to destroy the earth." **GENESIS 9:11**
6. God said, "I set My _____ in the cloud, and it shall be for the sign of the covenant between Me and the earth." **GENESIS 9:13**
7. "The rainbow shall be in the cloud, and I will look on it to remember the _____ between God and every living creature of all flesh that is on the earth." **GENESIS 9:16**

9. GOD'S COVENANT

(GENESIS 8:20-9:17)

O F F R B J I U U P P I F V Y Q A J Y G Q Y U Z A
F J U S R N I G I R Z Q I H H J S T E A E W V L L
G U M B T D D F P Y S S U Y F J P B H T P C T W A
Q X N B E Y Z Y N R T S H G Q C W V L N G A W W Z
C K V Z W A P I S E V O I M M R J Q B B R N A V Y
F B S F R I Z F R E B M E M E R E O R K R R T H E
C D L O G B V B C S I G N L H S H V O L A G Z W K
J C M W F L U S N L G E P U T V G Y W D I I V S G
K A B P D O D L G V W Z K A M O N X H O N K K R Z
V Z M Y E N O A H N D P B V D D F C J H B F B V S
O R I L S U W A P T I L R E G F L O O D O T M B B
B D O N S P E E C O I R E Z Q I G J S Y W S S K E
Y Y X D E W E Z K S K E E M W M I N R Q G T H G W
D Q K C L C B C H J A U N F G O E B V K L O J P G
G Q E V B P D L C Q G V A M F O G L J G Y Y L E B
C H Y O Z R V W X L S N I I H O W L D O T T X I T
L O R D A F S C P P A I P V W F P C O V E N A N T
X F T S N N N A R V U A Q Q D U O D U J P T B N D
E O E K O M P Z E G K G F B I D I N V M V G K A P
D I Z S S E Y S M Y S A R V C I L K C N E F N V T
K U Q L H T G D H Q Y R C B P V D A G R N I P I C
Y H O D U L N G Y D X E G W L E S U O M J Y F W P
B H V L S M W P Y O F V O Y O M U W Q I A M H A N
Z Q L F C E Y C M O L E W U P N J K A F H R J M B
U U S A Y Z Z V B K K N J K D B L Y E J N A K H I

ALTAR
GOD
REMEMBER
COVENANT

FLOOD
RAINBOW
CLOUD
NOAH

OFFERINGS
BLESSED
NEVER AGAIN
SONS

AROMA
LORD
SIGN
ESTABLISH



9. GOD'S COVENANT (GENESIS 8:20-9:17)

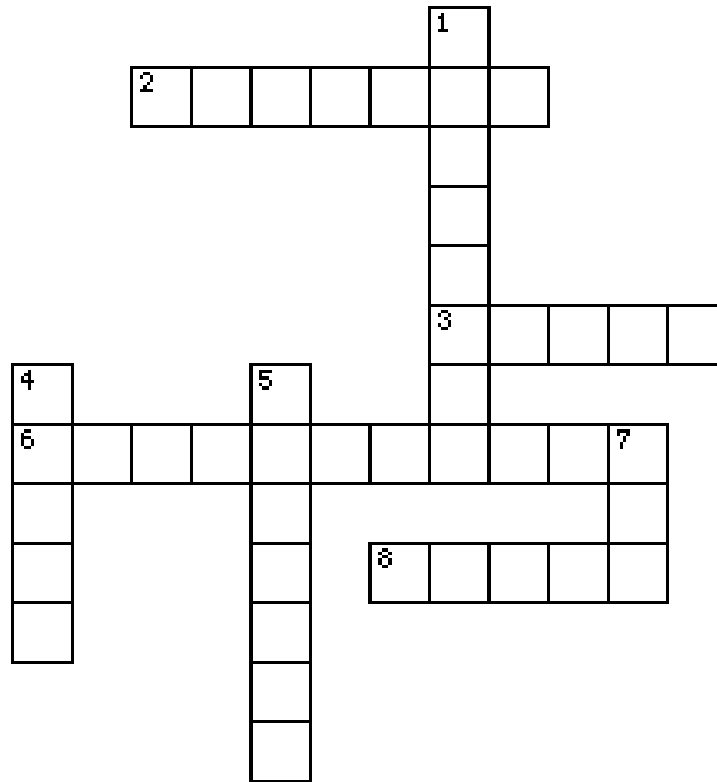

- 6 ACROSS "The rainbow shall be in the cloud, and I will look on it to remember the _____ covenant between God and every living creature of all flesh that is on the earth." **GENESIS 9:16**
- 3 ACROSS "Noah built an altar to the LORD, and took of every clean animal and of every clean bird, and offered burnt offerings on the _____." **GENESIS 8:20**
- 4 DOWN "And the LORD smelled a soothing aroma. Then the LORD said in His _____, 'I will never again curse the ground for man's sake.'" **GENESIS 8:21**
- 5 DOWN "So God _____ Noah and his sons, and said to them: 'Be fruitful and multiply, and fill the earth.'" **GENESIS 9:1**
- 1 DOWN "Then God spoke to Noah and to his sons with him, saying: 'And as for Me, behold, I establish My _____ with you and with your descendants after you.'" **GENESIS 9:8-9**
- 8 ACROSS "Thus I establish My covenant with you: Never again shall all flesh be cut off by the waters of the flood; never again shall there be a _____ to destroy the earth." **GENESIS 9:11**
- 2 ACROSS God said, "I set My _____ in the cloud, and it shall be for the sign of the covenant between Me and the earth." **GENESIS 9:13**
- 7 DOWN "The rainbow shall be in the cloud, and I will look on it to remember the everlasting covenant between _____ and every living creature of all flesh that is on the earth." **GENESIS 9:16**

Bible Story 10

THE TOWER OF BABEL

GENESIS 10:8-10; 11:1-9

10. THE TOWER OF BABEL

(GENESIS 10:8-10; 11:1-9)

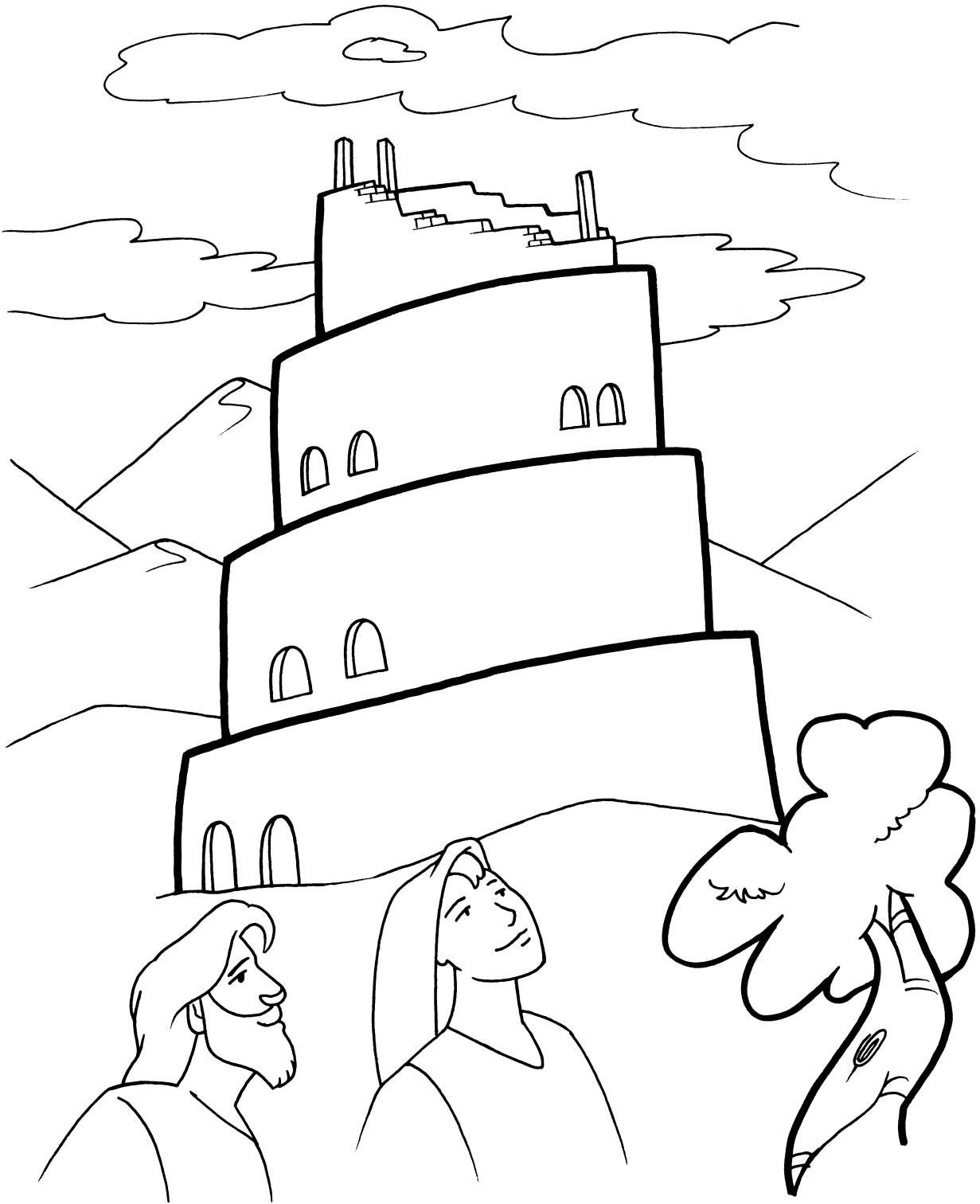

"And they said, Go to, let us build us a city and a tower, whose top *may reach* unto heaven; and let us make us a name, lest we be scattered abroad upon the face of the whole earth."

GENESIS 11:4

10. THE TOWER OF BABEL

(GENESIS 10:8-10; 11:1-9)

MEMORY VERSE:

*"And He will bring down their pride together with the trickery of their hands."
ISAIAH 25:11*

TRUE OR FALSE:

1. "Now the whole earth had one language and one speech." **GENESIS 11:1**
TRUE OR FALSE
2. And it came to pass, as they journeyed from the east, that they found a plain in the land of Shinsplints, and they dwelt there. **GENESIS 11:2**
TRUE OR FALSE

FILL IN THE BLANKS:

3. "And they said, 'Come, let ____ build _____ a city, and a tower whose top is in the heavens; let ____ make a name for _____, lest ____ be scattered abroad over the face of the whole earth.'" **GENESIS 11:4**

CIRCLE THE CORRECT WORDS:

4. "And the LORD said, 'Indeed the people are one and they all have one (**LANGUAGE, HAIRDO**), and this is what they begin to do; now (**EVERYTHING, NOTHING**) that they propose to do will be withheld from them.'" **GENESIS 11:6**

TRUE OR FALSE:

5. The LORD said, "Come, let Us go down and there confuse their language, that they may not understand one another's speech." **GENESIS 11:7**
TRUE OR FALSE
6. "So the LORD scattered them abroad from there over the face of all the earth, and they ceased from building the city." **GENESIS 11:8**
TRUE OR FALSE

CIRCLE THE CORRECT WORDS:

7. "Therefore its name is called (**BABY, BABEL**), because there the LORD confused the language of all the earth; and from there the LORD (**SCARED, SCATTERED**) them abroad over the face of all the earth." **GENESIS 11:9**

10. THE TOWER OF BABEL

(GENESIS 10:8-10; 11:1-9)

A L A N G U A G E S H I N A R
D L O R D S Q I B E N O Y O O
N O Y Y M J S A J V E N S E M
A Y T I C C B B W B N W F K S
T O G J U E A U C Z O Z M A H
S C V S L K N E S Y T S Y E U
R O H G E T I P C T S J Z G N
E N W R S N E V A E H N D W T
D F S D F F E N T F A I T P E
N U X S C H S Z T M A M T V R
U S A K H S P E E C H R E J R
R E S C Y U R F R I J O U E P
Y I E I U T P H E B Z D W C H
K K W R I T X F D Z G O L F D
I H Y B F A I M D W T M F H A

BABEL	HUNTER	SCATTERED	BAKE
LANGUAGE	SHINAR	BRICKS	LORD
SPEECH	CITY	NAME	STONE
CONFUSE	NIMROD	TOWER	CUSH
ONE	UNDERSTAND	HEAVENS	

FILL IN THE LETTERS OF THE VERSE BELOW,

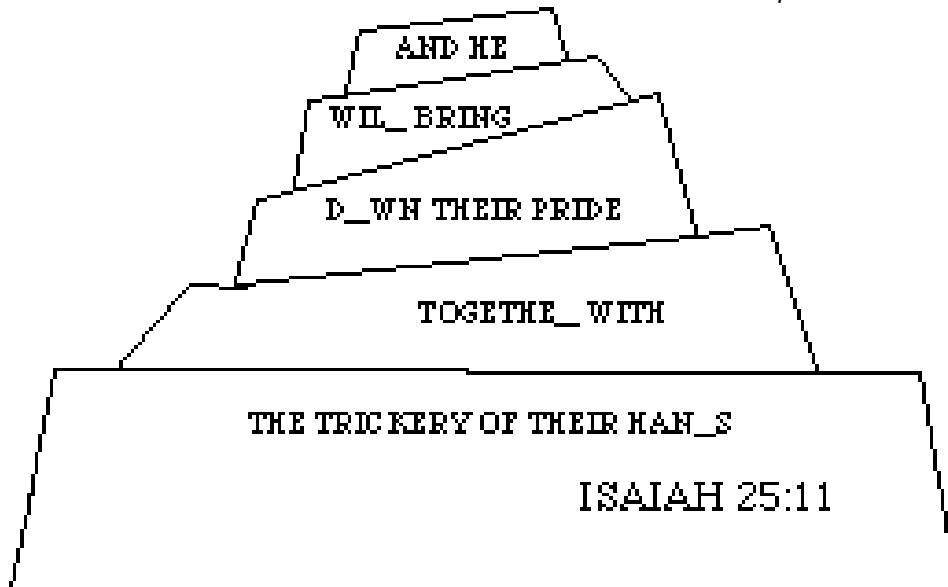

NOW USE THOSE LETTERS TO ANSWER THIS QUESTION...

Who will bring down their pride? "THE _ _ _ _"

10. THE TOWER OF BABEL

(GENESIS 10:8-10; 11:1-9)

MEMORY VERSE:

"And He will bring down their pride together with the trickery of their hands. The fortress of the high fort of your walls He will bring down, lay low, and bring to the ground, down to the dust." ISAIAH 25:11-12

TRUE OR FALSE:

1. "Now the whole earth had one language and one speech." **GENESIS 11:1**
TRUE OR FALSE
2. And it came to pass, as they journeyed from the east, that they found a plain in the land of Shinsplints, and they dwelt there. **GENESIS 11:2**
TRUE OR FALSE

FILL IN THE BLANKS:

3. "And they said, 'Come, let ____ build _____ a city, and a tower whose top is in the heavens; let ____ make a name for _____, lest ____ be scattered abroad over the face of the whole earth.'" **GENESIS 11:4**
4. "And the LORD said, 'Indeed the people are one and they all have one _____, and this is what they begin to do; now _____ that they propose to do will be withheld from them.'" **GENESIS 11:6**

TRUE OR FALSE:

5. The LORD said, "Come, let Us go down and there confuse their language, that they may not understand one another's speech." **GENESIS 11:7**
TRUE OR FALSE

FILL IN THE BLANKS:

6. "So the LORD scattered them abroad from there over the face of all the earth, and they _____ from building the city." **GENESIS 11:8**
7. "Therefore its name is called _____, because there the LORD confused the language of all the earth; and from there the LORD _____ them abroad over the face of _____ the earth." **GENESIS 11:9**

10. THE TOWER OF BABEL

(GENESIS 10:8-10; 11:1-9)

V Z M X F B P I S P K L U O W L I D U Q I H R J N
 O R I Y Z L Z F C R P K V W Y O V S W A F N A I M
 B D O L A O V B N Y Z I F J U B E U K E J Y M K H
 Y Y X N N U U L P R S Q I V K A M J Y G Q R U Z L
 D Q K D S S D A C E T S U H Y K N L Y A O W V W A
 G Q E C P P W E S N E V A E H E L J E D S C W W Z
 C H Y E H W E Z X C I T Y Y H A B T H T H N A V Y
 X F E V U C E D C X V S H G N P L B L N I R T H E
 E C T O R P B C E V G O I G F O A V B B N G Z W K
 H O O N E R D L H R W E U M R D S Q R K A I V S G
 K I E S T F V W S T E A P D Q Q P O O L R K K R Z
 Y H Z K N M N C U O G T K X X J W V W D E F B V S
 B H Q L U E P A C E D Z T U H J J Y H O P T M B B
 Z Q V D H T Y Z X J K P R A M C H X J H G S S K E
 U U L F B A B E L Q A E E V C X N C S Y G T H G W
 F F S A S L G S P L G D N E G S F J R Q L O J P G
 T O W E R M E D R P S N A Z Q V G C O N F U S E B
 J U R B Y M N G E V A A I U W D I N V K Y Y L E T
 U M S R A E W P E N O T S U G I E B J G T T X I D
 S N B N J Z Y C M G U S P I X M G L D O P T B N P
 X K B X N I Z V H Y K R Q X W O W L U J V G K A T
 K V C E D I U U Y Q S E F Q D O K D V M E F N V C
 B S Z I Y D G I Y D Y D R B I F O N C N N I P I P
 D L F W R Z F P M O X N C V C U I K G R J Y F W N
 C B W G I B Y N B O F U G B P D L A O M A M H A B

BABEL	HUNTER	SCATTERED	BAKE	LANGUAGE
SHINAR	BRICKS	LORD	SPEECH	CITY
NAME	STONE	CONFUSE	NIMROD	TOWER
CUSH	ONE	UNDERSTAND	HEAVENS	

FILL IN THE LETTERS OF THE VERSE BELOW,

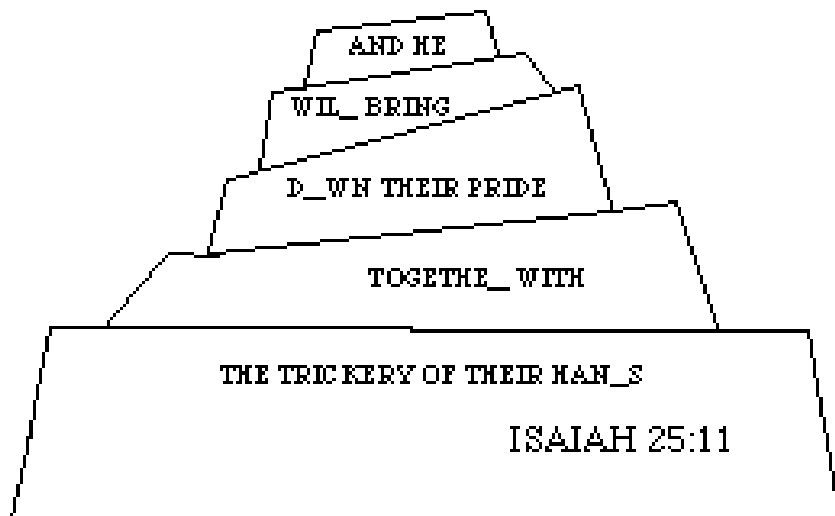

NOW USE THOSE LETTERS TO ANSWER THIS QUESTION...

Who will bring down their pride? "THE _ _ _ _"

10. THE TOWER OF BABEL

(GENESIS 10:8-10; 11:1-9)

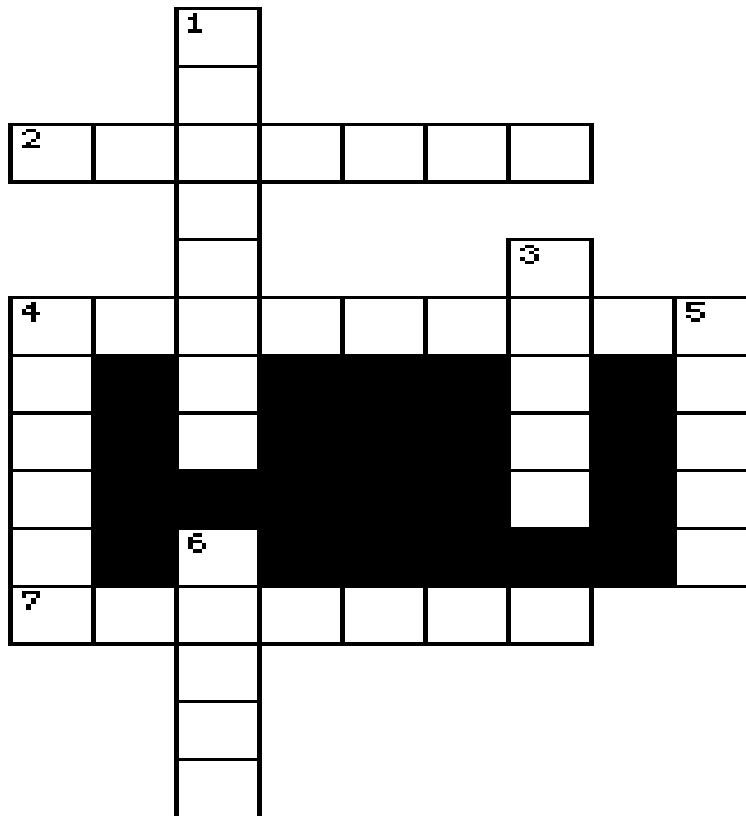

- 3 DOWN "And He will bring down their _____ together with the trickery of their hands." **ISAIAH 25:11**
- 4 DOWN "Now the whole earth had one language and one _____." **GENESIS 11:1**
- 5 DOWN "And it came to pass, as they journeyed from the east, that they found a plain in the land of Shinar, and they _____ there." **GENESIS 11:2**
- 7 ACROSS "And they said, 'Come, let us build ourselves a city, and a tower whose top is in the _____ let us make a name for ourselves, lest we be scattered abroad over the face of the whole earth.'" **GENESIS 11:4**
- 1 DOWN "And the LORD said, 'Indeed the people are one and they all have one _____, and this is what they begin to do; now nothing that they propose to do will be withheld from them.'" **GENESIS 11:6**
- 2 ACROSS The LORD said, "Come, let Us go down and there _____ their language, that they may not understand one another's speech." **GENESIS 11:7**
- 4 ACROSS "So the LORD _____ them abroad from there over the face of all the earth, and they ceased from building the city." **GENESIS 11:8**
- 6 DOWN "Therefore its name is called _____, because there the LORD confused the language of all the earth; and from there the LORD scattered them abroad over the face of all the earth." **GENESIS 11:9**

Bible Story 11

GOD CALLS ABRAM

GENESIS 11:26-12:9

11. GOD CALLS ABRAM

(GENESIS 11:26-12:9)

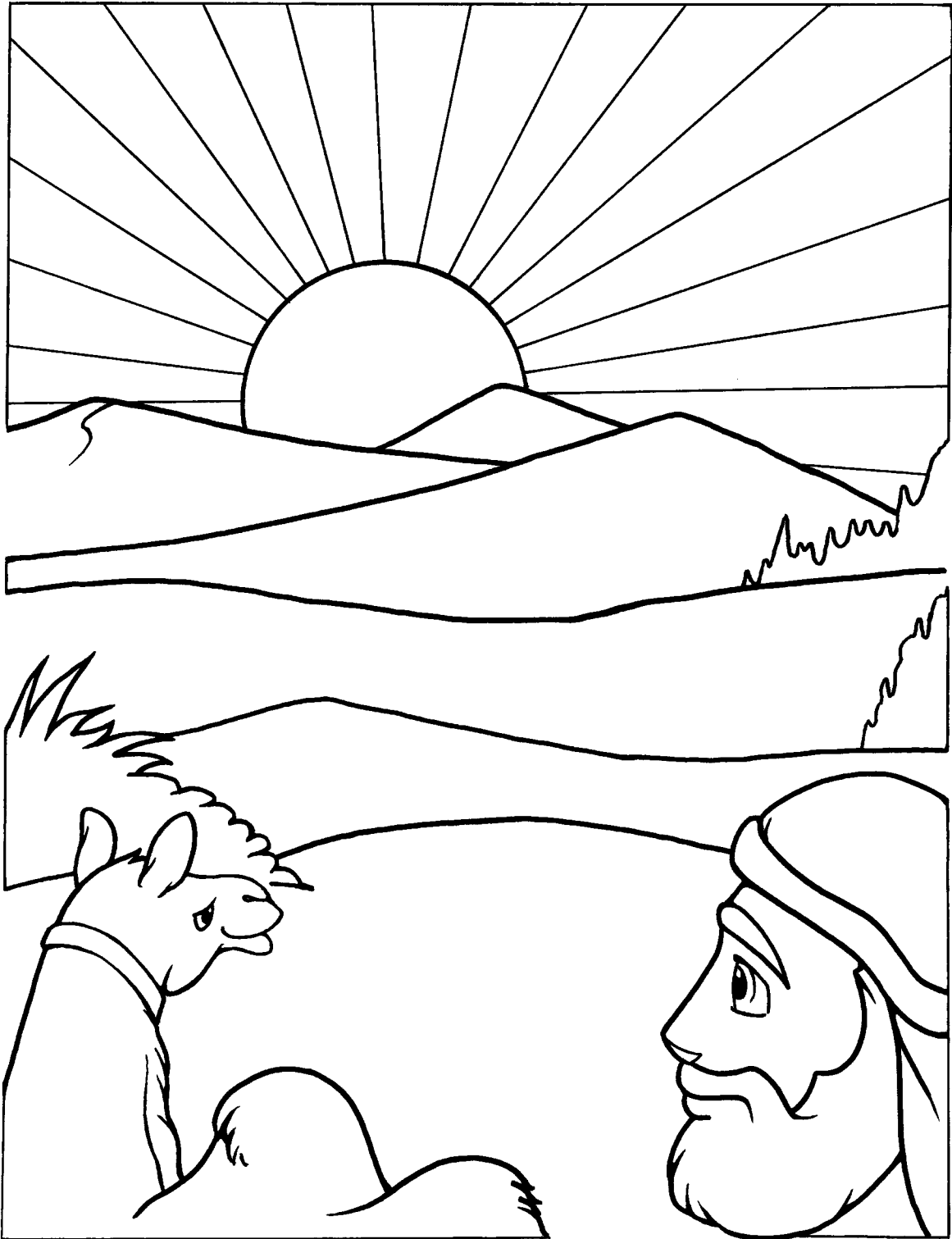

"By faith Abraham obeyed when he was called to go out to the place which he would afterward receive as an inheritance."

HEBREWS 11:8

11. GOD CALLS ABRAM

(GENESIS 11:26-12:9)

MEMORY VERSE:

"By faith Abraham obeyed when he was called to go out to the place which he would afterward receive as an inheritance." HEBREWS 11:8

CIRCLE THE CORRECT WORDS:

1. "Now the LORD had said to Abram..." **GENESIS 12:1-3**
'Get out of your country,
from your kindred and from your father's house,
to a land that (**I, YOU**) will show you.
(**I, YOU**) will make you a great nation;
(**I, YOU**) will bless you and make your name great;
and you shall be a blessing.
(**I, YOU**) will bless those who bless you,
and (**I, YOU**) will curse him who curses you;
and in you all the families of the earth shall be blessed.'
2. "Then Abram took (**SANDRA, SARAI**) his wife and (**LOT, LOOT**) his brother's son, and all their possessions that they had gathered, and the people whom they had acquired in (**HAIRLAND, HARAN**), and they departed to go to the land of (**CANDY, CANAAN**)."
GENESIS 12:5

TRUE OR FALSE:

3. "Abram passed through the land to the place of Shechem, as far as the terebinth tree of Moreh. And the Canaanites were then in the land." **GENESIS 12:6**
TRUE OR FALSE
4. "Then the LORD appeared to Abram and said, 'To your descendants I will give this land.'" **GENESIS 12:7**
TRUE OR FALSE

FILL IN THE BLANKS:

5. "And there he built an _____ to the LORD, who had appeared to him. And he moved from there to the mountain east of Bethel, and he pitched his tent with Bethel on the west and Ai on the east; there he built an _____ to the LORD and called on the name of the LORD." **GENESIS 12:7-8**

11. GOD CALLS ABRAM

(GENESIS 11:26-12:9)

A M A R B A Z P F Z E E W Y N
M V H D W B Z I A B A R U P G
X Q A E Z K K Q Y N E U B Y Z
T T E R A H C D Y S O T M B J
C Z G N I S S E L B W I H D P
Y A W P K E T O O H L W T E N
A U N Z K F T J F M Z D W A L
L A X A Q J I Q V M M W U R N
T S T N A D N E C S E D F C U
A N P C J N O R M S D R O L O
R M E C B T T I S V P Y I G F
L G S Q B E A L V N E R R A B
C H A L D E A N S O J W O H S
I F G I R J N S M J H P X R L
O I A R A S R T A J G Z G G L

ABRAM	CANAAN	NATION	ALTAR
CHALDEANS	SARAI	BARREN	DESCENDANTS
SHOW	BETHEL	LORD	TERAH
BLESSING	LOT	UR	

Help Abram get to Canaan

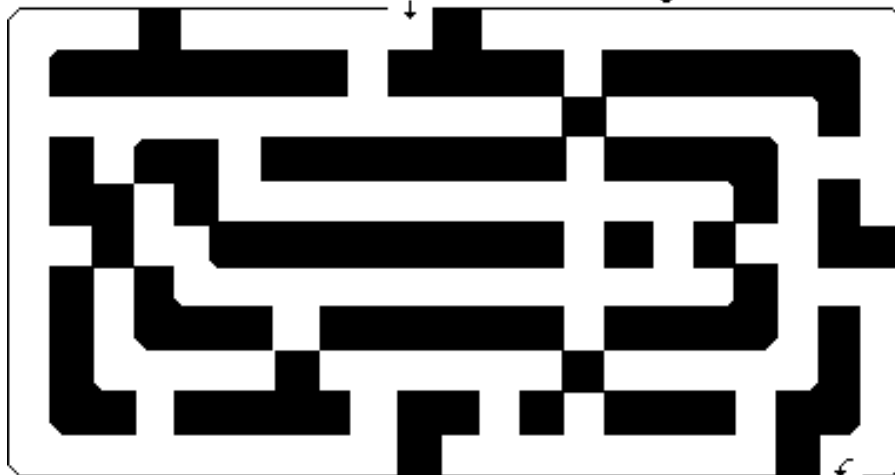

Welcome to the land of Canaan!

11. GOD CALLS ABRAM

(GENESIS 11:26-12:9)

MEMORY VERSE:

"By faith Abraham obeyed when he was called to go out to the place which he would afterward receive as an inheritance. And he went out, not knowing where he was going." HEBREWS 11:8

FILL IN THE BLANKS:

1. "Now the LORD had said to Abram..." **GENESIS 12:1-3**
'Get out of your country,
from your kindred and from your father's house,
to a land that _____ will show you.
_____ will make you a great nation;
_____ will bless you and make your name great;
and you shall be a blessing.
_____ will bless those who bless you,
and _____ will curse him who curses you;
and in you all the families of the earth shall be blessed.'
2. "Then Abram took _____ his wife and _____ his brother's son, and all their possessions that they had gathered, and the people whom they had acquired in _____, and they departed to go to the land of _____." **GENESIS 12:5**

TRUE OR FALSE:

3. "Abram passed through the land to the place of Shechem, as far as the terebinth tree of Moreh. And the Canaanites were then in the land." **GENESIS 12:6**
TRUE OR FALSE
4. "Then the LORD appeared to Abram and said, 'To your descendants I will give this land.'" **GENESIS 12:7**
TRUE OR FALSE

FILL IN THE BLANKS:

5. "And there he built an _____ to the LORD, who had appeared to him. And he moved from there to the mountain east of Bethel, and he pitched _____ his tent with Bethel on the west and Ai on the east; there he built an _____ to the LORD and called on the name of the LORD." **GENESIS 12:7-8**

11. GOD CALLS ABRAM (GENESIS 11:26-12:9)

R G H W O S Z U A E U N L R U M I B S M H X V R P
 F E S E Z L N T Y P T C W F A G H R U J X D F U M
 H Y S L M P K T N I O V W Y D O J W X Q A K H K L
 E G R D F D O D S A M B E T H E L G H L U X N B C
 L M R V M U E H Q Y A C Z X D V D T U J V U E I S
 M O V D Q T O S U B J N O D W S U K Q T A Y E F G
 L Q N D S W B D C I A R A S T P O W N E R R A B E
 G H G Z Q N H Q Q E K C A C L T L I T W E E M W Y
 M V D Z V D F C T B N H K F A W B U P K I E J L U
 B V P O P R V U H P G D U B O B L M L N S J Q J W
 P G K W B A I J T P R R A E A H E F J O G A V B I
 M S S H Q Z O K T Y H A N N P J S O B I J V E B A
 W N P Q J E N S R F G E T H T Y S E J T P K L O T
 N B T I I M H M R O D M U L A S I P H A Z U V K C
 G K P E C D I C W J V Q D T A K N K T N F O V J L
 K K R L R W U J H W B N L L D P G J J M B Z L K P
 B O X H T A A T P A G Y U U Y G O F Y L X X A U A
 Y J O T C Q H A N S L M F W S K M Y R U K A I M I
 K Q S Y J X F A K S C D L Q M G A T D G M M L X E
 P S L O W I F U B I Z A E N U P R W C C Z Z R Y Y
 U P K A Y T T E C A H S Y A X S B U G V X B U R A
 Y M W V J A Q N D G K V H I N O A G S U I T U T Q
 F B V C T L H Q W W K Y X S S S U H Q B Z P C T A
 K B J A N B A X K A R K O V E T I X U U F Z Q C O
 T O X L A Z U N I F E W I U J W I V R N Z F N M Y

ABRAM	CANAAN	NATION	ALTAR
CHALDEANS	SARAI	BARREN	DESCENDANTS
SHOW	BETHEL	LORD	TERAH
BLESSING	LOT	UR	

Help Abram get to Canaan

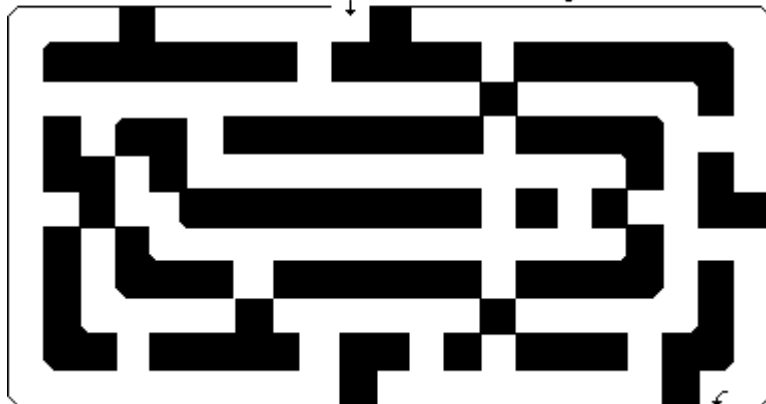

Welcome to the land of Canaan!

11. GOD CALLS ABRAM

(GENESIS 11:26-12:9)

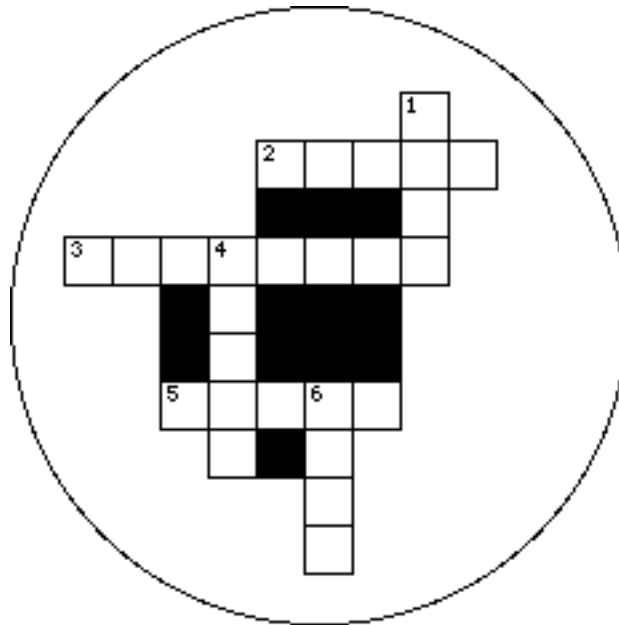

- 5 ACROSS "By _____ Abraham obeyed when he was called to go out to the place which he would afterward receive as an inheritance." **HEBREWS 11:8**
- 4 DOWN "Now the LORD had said to _____ 'Get out of your country, from your kindred and from your father's house, to a land that I will show you.'" **GENESIS 12:1**
- 3 ACROSS "Then Abram took Sarai his wife and Lot his brother's son, and all their possessions that they had gathered, and the people whom they had acquired in Haran, and they _____ to go to the land of Canaan." **GENESIS 12:5**
- 6 DOWN "Abram passed through the land to the place of Shechem, as far as the terebinth _____ of Moreh. And the Canaanites were then in the land." **GENESIS 12:6**
- 1 DOWN "Then the LORD appeared to Abram and said, 'To your descendants I will give this _____'" **GENESIS 12:7**
- 2 ACROSS "And there he built an _____ to the LORD, who had appeared to him. And he moved from there to the mountain east of Bethel, and he pitched his tent with Bethel on the west and Ai on the east; there he built an altar to the LORD and called on the name of the LORD." **GENESIS 12:7-8**

Bible Story 12

**ABRAM AND SARAI
VISIT EGYPT**

GENESIS 12:10-13:1

12. ABRAM AND SARAI VISIT EGYPT (GENESIS 12:10-13:1)

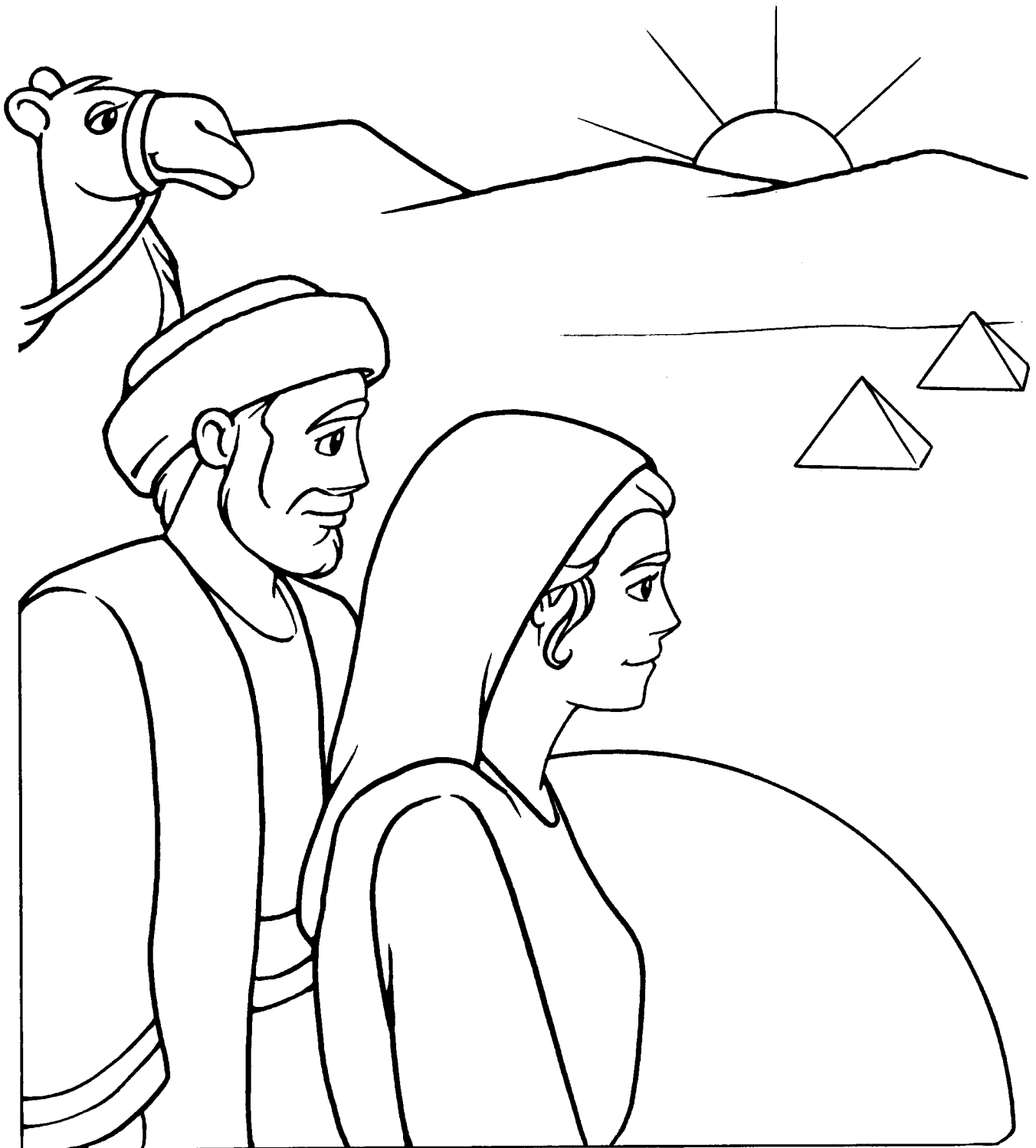

"And there was a famine in the land: and Abram went down into Egypt to sojourn there; for the famine was grievous in the land."

GENESIS 12:10

12. ABRAM AND SARAI VISIT EGYPT

(GENESIS 12:10-13:1)

MEMORY VERSE:

"Blessed is that man who makes the LORD his trust, and does not respect the proud, nor such as turn aside to lies." PSALM 40:4

FILL IN THE BLANK:

1. "There was a famine in the land, and Abram went down to _____ to sojourn there, for the famine was severe in the land." **GENESIS 12:10**

CIRCLE THE CORRECT WORDS:

2. "And it came to pass, when he was close to entering (**CANAAN, EGYPT**), that he said to Sarai his wife, 'Indeed I know that you are a woman of (**BEAUTIFUL, SAD**) countenance.'" **GENESIS 12:11**
3. Abram said, "Therefore it will happen, when the Egyptians see you, that they will say, 'This is his wife'; and they will (**KICK, KILL**) me, but they will let you live." **GENESIS 12:12**
4. Then Abram said, "Please say you are my (**FRIEND, SISTER**), that it may be well with me for your sake, and that I may live because of you." **GENESIS 12:13**

TRUE OR FALSE:

5. "But the LORD plagued Pharaoh and his house with great plagues because of Sarai, Abram's wife." **GENESIS 12:17**

TRUE OR FALSE

6. "And Pharaoh called Abram and said, 'What is this you have done to me? Why did you not tell me that she was your wife?' " **GENESIS 12:18**

TRUE OR FALSE

7. So Pharaoh commanded his men concerning him; and they asked him to stay, with his wife and all that he had. **GENESIS 12:20**

TRUE OR FALSE

12. ABRAM AND SARAI VISIT EGYPT

(GENESIS 12:10-13:1)

P H O A R A H P P O Q J D R T
Z H L H B F S E E E L S Q F T
Y A J R O S J W P P K U E E P
Y C A M E L S E D E D E N J Y
O M S E C N I R P E E A R O G
J H S P A W H B V T U H Y U E
S Z C I W L O R D C D G S G W
E Y V J S U Q K A S O V A F L
V L U F I T U A E B K S Y L A
E N E F I W E S R C Q Y D K P
R J I A R A S R L H K E J D P
E T T H V D O U W U L K I B P
S E R V A N T S J E W N P K A
F P W Q M N E X O C K O T K X
A E N I M A F H U N I D V A V

ABRAM
SEVERE
PLAGUED
FAMINE

LORD
CAMELS
SISTER
SARAI

SERVANTS
PHARAOH
EGYPT

BEAUTIFUL
SHEEP
PRINCES

OXEN
DONKEYS
WIFE

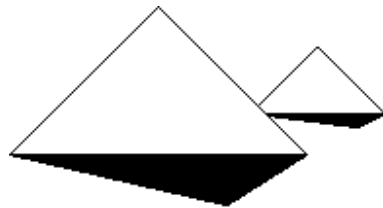

12. ABRAM AND SARAI VISIT EGYPT

(GENESIS 12:10-13:1)

MEMORY VERSE:

"Blessed is that man who makes the LORD his trust, and does not respect the proud, nor such as turn aside to lies." PSALM 40:4

FILL IN THE BLANKS:

1. "There was a famine in the land, and Abram went down to _____ to sojourn there, for the famine was _____ in the land." **GENESIS 12:10**
2. "And it came to pass, when he was close to entering _____, that he said to Sarai his wife, 'Indeed I know that you are a woman of _____ countenance.'" **GENESIS 12:11**

CIRCLE THE CORRECT WORD:

3. Abram said, "Therefore it will happen, when the Egyptians see you, that they will say, 'This is his wife'; and they will (**KICK, KILL**) me, but they will let you live." **GENESIS 12:12**

FILL IN THE BLANKS:

4. Then Abram said, "Please say you are my _____, that it may be well with me for your sake, and that I may live because of you." **GENESIS 12:13**
5. "But the LORD plagued Pharaoh and his house with _____ because of Sarai, Abram's wife." **GENESIS 12:17**

TRUE OR FALSE:

6. "And Pharaoh called Abram and said, 'What is this you have done to me? Why did you not tell me that she was your wife?' " **GENESIS 12:18**
TRUE OR FALSE
7. So Pharaoh commanded his men concerning him; and they asked him to stay, with his wife and all that he had. **GENESIS 12:20**
TRUE OR FALSE

12. ABRAM AND SARAI VISIT EGYPT

(GENESIS 12:10-13:1)

G Q B U G J K Q S A W G L S E H P H L K
X D E U G A L P V W B R M V J A J Q W D
G Y I A D B C R M L M C H R K H H O J D
R E A N E B T I A Z W A S O K Z Q E U O
Q S A R A I I L Z X U M Z C A Y O W O K
I L S Y E K N O D P F E F M P R A E E Q
P N M F P R O S S J I L P L E N A B P K
H V I M Z B T T H H X S G B G J W H T L
Z W X G C K A F M G G G K X Y T V K P W
F Q T F C E A B X E B N R A P P M S C K
A T Y H Q F N A R U Y E B C T L F U S I
M S T N A V R E S A T G A W Z J S E C J
I A L A I J R Y S S M Z U U Y C R H H S
N Q I W W T P Y I W P J K J T E W P U U
E F O X Z E I S V D O P C U V I U E E E
I H V P K J Q O O X Y N U E Y V F V C A
P R I N C E S F E W B U S K O T D U N V
V P Q E K Z D N J Y D O M O J D R O L D
V J P E E H S V J P R F D I F W S A Q Q
B T Z S Q Z J X E Z C L L T A H J R L E

ABRAM
SEVERE
PLAGUED
FAMINE

LORD
CAMELS
SISTER
SARAI

SERVANTS
PHARAOH
EGYPT

BEAUTIFUL
SHEEP
PRINCES

OXEN
DONKEYS
WIFE

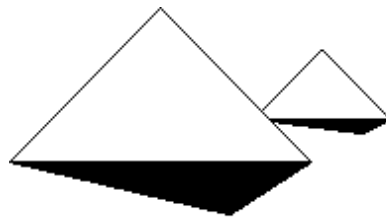

12. ABRAM AND SARAI VISIT EGYPT (GENESIS 12:10-13:1)

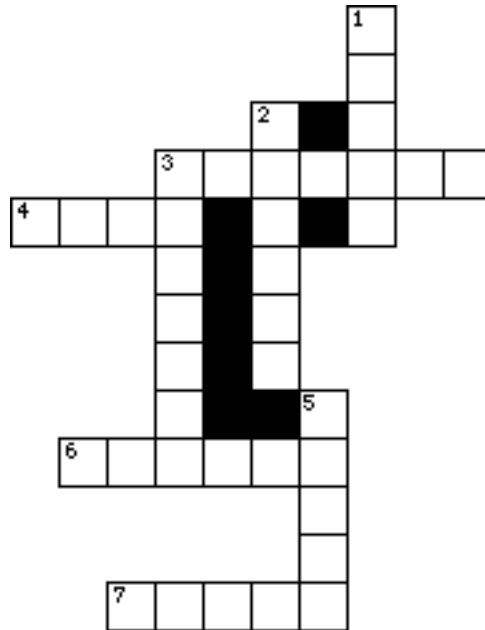

- 5 DOWN "Blessed is that man who makes the LORD his _____, and does not respect the proud, nor such as turn aside to lies." **PSALM 40:4**
- 2 DOWN "There was a _____ in the land, and Abram went down to Egypt to sojourn there, for the famine was severe in the land." **GENESIS 12:10**
- 7 ACROSS "And it came to pass, when he was close to entering _____, that he said to Sarai his wife, 'Indeed I know that you are a woman of beautiful countenance.' " **GENESIS 12:11**
- 4 ACROSS Abram said, "Therefore it will happen, when the Egyptians see you, that they will say, 'This is his wife'; and they will _____ me, but they will let you live." **GENESIS 12:12**
- 6 ACROSS Then Abram said, "Please say you are my _____, that it may be well with me for your sake, and that I may live because of you." **GENESIS 12:13**
- 3 DOWN "But the LORD plagued Pharaoh and his house with great _____ because of Sarai, Abram's wife." **GENESIS 12:17**
- 1 DOWN "And Pharaoh called _____ and said, 'What is this you have done to me? Why did you not tell me that she was your wife?' " **GENESIS 12:18**
- 3 ACROSS "So _____ commanded his men concerning him; and they sent him away, with his wife and all that he had. **GENESIS 12:20**

Bible Story 13

LOT LEAVES ABRAM

GENESIS 13:6-18

13. LOT LEAVES ABRAM

(GENESIS 13:6-18)



"Is not the whole land before thee? separate thyself, I pray thee, from me: if *thou wilt take* the left hand, then I will go to the right; or if *thou depart* to the right hand, then I will go to the left."

GENESIS 13:9

13. LOT LEAVES ABRAM

(GENESIS 13:6-18)

MEMORY VERSE:

"I will make your descendants as the dust of the earth; so that if a man could number the dust of the earth, then your descendants also could be numbered."
GENESIS 13:16

CIRCLE THE CORRECT WORDS:

1. As for Abram and Lot, "the land was not able to support them, that they may dwell together, for their possessions were so (**GREAT, SMALL**) that they could not dwell together."
GENESIS 13:6
2. "So Abram said to Lot, 'Please let there be no (**FRIENDSHIP, STRIFE**) between you and me, and between my herdsmen and your herdsmen; for we are brethren.'" GENESIS 13:8

MATCHING:

FINISH THE VERSE BY DRAWING A LINE CONNECTING ABRAM'S RESPONSE FROM THE COLUMN ON THE RIGHT:

3. Abram said to Lot, "Is not the whole land before you? Please separate from me..."
GENESIS 13:9

IF YOU TAKE THE LEFT

THEN I WILL GO TO THE LEFT

IF YOU GO TO THE RIGHT

THEN I WILL GO TO THE RIGHT

TRUE OR FALSE:

4. "Then Lot chose for himself all the plain of Jordan, and Lot journeyed east. And they separated from each other." GENESIS 13:11
TRUE OR FALSE

FILL IN THE BLANKS:

5. "Abram dwelt in the land of _____, and Lot dwelt in the cities of the plain and pitched his tent even as far as _____." GENESIS 13:12

UNDERLINE THE CORRECT WORDS:

6. "And the LORD said to Abram, after Lot had separated from him: 'Lift your eyes now and look from the place where you are- (**NORTHWARD, SOUTHWARD, UPWARD, DOWNWARD, EASTWARD, BACKWARD, & WESTWARD**); for all the land which you see I give to you and your descendants forever." GENESIS 13:14-15

13. LOT LEAVES ABRAM (GENESIS 13:6-18)

S L N M O D O S U X U Z T T I
 E W W A L K A S T N L K M X L
 P K R R K W X M M E P F Z N L
 A I Y F D L V C M A V K J E E
 R J D E R E B M U N R I S R W
 A S Y E B A Q Z O O M B G H D
 T U D R I G H T E L O T A T K
 E E J J K P D N A A N A C E X
 D S N O I S S E S S O P M R P
 D A I O K E F I R T S S X B P
 O V N E M S D R E H C M P X U
 K D P U A P V L M B S E Y E Z
 D E S C E N D A N T S O C G V
 Q Q T G T R A T L A C T F E L
 K E V F N A D R O J V A D E F

ABRAM	GIVE	POSSESSIONS	ALTAR
HERDSMEN	RIGHT	BRETHREN	JORDAN
SEPARATE	CANAAN	LEFT	SODOM
DESCENDANTS	LOT	STRIFE	DWELL
NUMBERED	WALK	EYES	

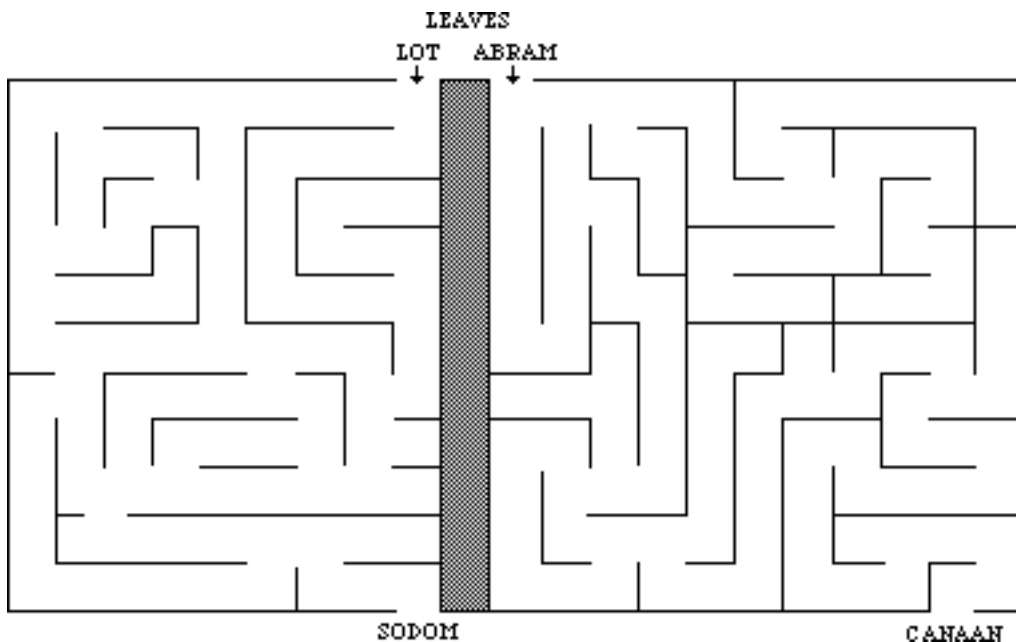

13. LOT LEAVES ABRAM

(GENESIS 13:6-18)

MEMORY VERSE:

"I will make your descendants as the dust of the earth; so that if a man could number the dust of the earth, then your descendants also could be numbered."
GENESIS 13:16

FILL IN THE BLANKS:

1. As for Abram and Lot, "the land was not able to support them, that they may dwell together, for their possessions were so _____ that they could not dwell together."
GENESIS 13:6
2. "So Abram said to Lot, 'Please let there be no _____ between you and me, and between my herdsmen and your herdsmen; for we are _____.'"
GENESIS 13:8

MATCHING:

FINISH THE VERSE BY DRAWING A LINE CONNECTING ABRAM'S RESPONSE FROM THE COLUMN ON THE RIGHT:

3. Abram said to Lot, "Is not the whole land before you? Please separate from me..."
GENESIS 13:9

IF YOU TAKE THE LEFT

THEN I WILL GO TO THE LEFT

IF YOU GO TO THE RIGHT

THEN I WILL GO TO THE RIGHT

TRUE OR FALSE:

4. "Then Lot chose for himself all the plain of Jordan, and Lot journeyed east. And they separated from each other." **GENESIS 13:11**
TRUE OR FALSE

FILL IN THE BLANKS:

5. "Abram dwelt in the land of _____, and Lot dwelt in the cities of the plain and pitched his tent even as far as _____." **GENESIS 13:12**
6. "And the LORD said to Abram, after Lot had separated from him: 'Lift your eyes now and look from the place where you are- _____, _____, _____, and _____; for all the land which you see I give to you and your descendants forever.'" **GENESIS 13:14-15**
7. "Then Abram moved his tent, and went and dwelt by the _____ of Mamre, which are in Hebron, and built an _____ there to the LORD." **GENESIS 13:18**

13. LOT LEAVES ABRAM (GENESIS 13:6-18)

E G X V A O J W G V U I O L W C U F F W E E S M M M U I A H
 L S O C S B K P W C D S V O U G V Z H L Y Q Z J C K X J D C
 M N S A L H S N A C L V S U G S A X N J U U P L U I W L P C
 G B L L T F M K F E A U P H E R D S M E N T J P R R V M U N
 M K K F P V D B U B F U T I H Q J D E B W V H O S K K P K U
 B K E E U I J E R H U I W I X U O K E B I S D L J Q G X I K
 P L W O V O T A S R F A R B V M R X M K T O L T L Y P E X S
 M O V Z T I M C T C L D B T S J D U J J A E C P S E Y E R U
 W J J M N N G D O E E D H R S Q A Y Q K C E T A R A P E S N
 N Q X F D H A W M M Y N J W U L N E V U L T U N P C H C Q E
 G S W M R I A K J Q H W D G X J E E E M B K U R B Z K H I S
 K P E Q A U U I K N X T Y A H T I J V X R N S D N A H M J X
 B M L S Z A E E G Y O L M T N W S A V Y E B Y E S K C X L T
 Y B V Q Z E F N P H M I A K O U T G V L R T Y J R L R O I J I
 K B D V M F Q I G A R O P K D K S K A T H Z G E P V W A L K
 P O D P D T X Y D S F A G W Q O J U I T R A A B H Z V V V L
 U H D B W Q N B P V Y P K I T M S O L C E X K M L Y N M R E
 Y S Z W Q H A B V O X A G U P L P Z R M N U R U Q E J T R I
 F S Z Q E A Y P B Y S D P M L U Z X U P P E B N U H L Q K A
 K R O J X L Q P G K D S S F J G F A U M A D N A I Z D V J K
 T V W I I U L Y C W F Y E T H G I R C N I K Y P C C R U S Q
 G N H C T U U F Z L B S O S B C B M Q A E G N L C S Z G F Y
 E G Q T A T Q O H W E M T O S V X Z N A Y C M Y M G X B Q R
 Y D I C L T T J K W H U W E J I K B R N A M Q M R I Y D V X
 G P L J B D H W K Z T X I P H U O T U A Q N P T X F A O X T
 M K H W Z D T S R O L S H K T B M N K C A Q L F G L E N R P
 Q S T Y Z Q T A R A U E J J J N Z P S L O R J H B B M Z B K
 H P Y J N C T S E K W J D F Y H X Z B C Y U D D I K X F I Z
 V P O T K L R I N U Q M U Y R X I F I S E M D R V M Z N U O
 V R A N A U R A C N N G O T D A Z V F G A E R S S I U X Q V

ABRAM
 HERDSMEN
 SEPARATE
 DESCENDANTS
 NUMBERED

GIVE
 RIGHT
 CANAAN
 LOT
 WALK

POSSESSIONS
 BRETHREN
 LEFT
 STRIFE
 EYES

ALTAR
 JORDAN
 SODOM
 DWELL

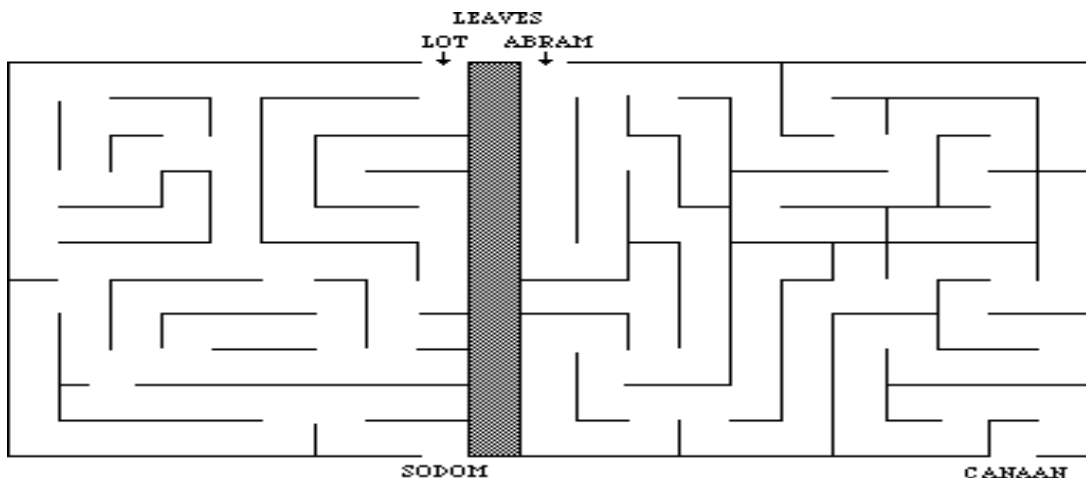

13. LOT LEAVES ABRAM (GENESIS 13:6-18)

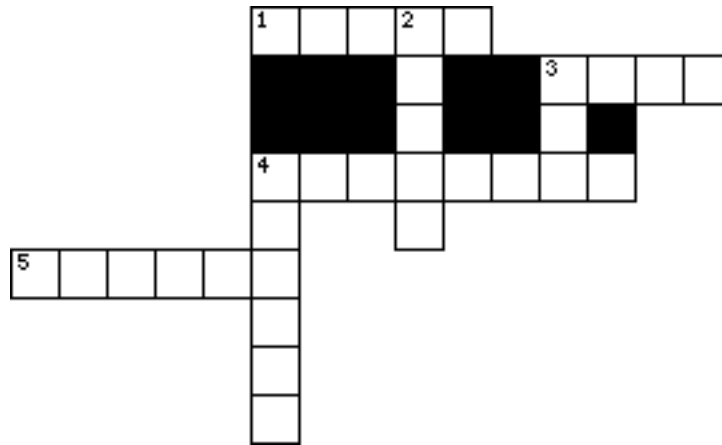

- 5 ACROSS "I will make your descendants as the dust of the earth; so that if a man could _____ the dust of the earth, then your descendants also could be numbered." **GENESIS 13:16**
- 1 ACROSS As for Abram and Lot, "the land was not able to support them, that they may dwell together, for their possessions were so _____ that they could not dwell together." **GENESIS 13:6**
- 4 DOWN "So Abram said to Lot, 'Please let there be no _____ between you and me, and between my herdsmen and your herdsmen; for we are brethren.'" **GENESIS 13:8**
- 4 ACROSS Abram said to Lot, "Is not the whole land before you? Please _____ from me." **GENESIS 13:9**
- 3 DOWN "Then _____ chose for himself all the plain of Jordan, and Lot journeyed east. And they separated from each other." **GENESIS 13:11**
- 2 DOWN "_____ dwelt in the land of Canaan, and Lot dwelt in the cities of the plain and pitched his tent even as far as Sodom." **GENESIS 13:12**
- 3 ACROSS "And the LORD said to Abram, after Lot had separated from him: 'Lift your eyes now and look from the place where you are- northward, southward, eastward, and westward; for all the _____ which you see I give to you and your descendants forever.'" **GENESIS 13:14-15**

Bible Story 14

**LOT'S CAPTIVITY
AND RESCUE**

GENESIS 14

14. LOT'S CAPTIVITY AND RESCUE

(GENESIS 14)



"And they took all the goods of Sodom and Gomorrah, and all their victuals, and went their way. And they took Lot, Abram's brother's son, who dwelt in Sodom, and his goods, and departed."

GENESIS 14:11-12

14. LOT'S CAPTIVITY AND RESCUE

(GENESIS 14)

MEMORY VERSE:

"Blessed be God Most High who has delivered your enemies into your hand."
GENESIS 14:20

FILL IN THE BLANKS:

1. "The king of _____, the king of _____, the king of Admah, the king of Zeboiim, and the king of Bela (that is Zoar) went out and joined together in _____ in the Valley of Siddim." **GENESIS 14:8**

TRUE OR FALSE:

2. "Now the Valley of Siddim was full of asphalt pits; and the kings of Sodom and Gomorrah fled; some fell there, and the remainder fled to the mountains." **GENESIS 14:10**
TRUE OR FALSE
3. "Then they took all the goods of Sodom and Gomorrah, and all their provisions, and went their way." **GENESIS 14:11**
TRUE OR FALSE

CIRCLE THE CORRECT WORDS:

4. "They also took Lot, Abram's brother's son who (**DWELT, SOJOURNED**) in Sodom, and his goods, and departed." **GENESIS 14:12**
5. "Now when Abram heard that his brother was taken captive, he armed his three hundred and eighteen trained servants who were born in his own house, and went in (**HIDING, PURSUIT**) as far as Dan." **GENESIS 14:14**

TRUE OR FALSE:

6. But he did not bring back any of the goods, neither did he bring back his brother Lot or his goods, neither the women nor any of the people. **GENESIS 14:16**
TRUE OR FALSE
7. "Then Melchizedek king of Salem brought out bread and wine; he was the priest of God Most High. And he blessed him." **GENESIS 14:18-19**
TRUE OR FALSE

FILL IN THE BLANK:

8. And Abram "gave him a _____ of all." **GENESIS 14:20**

14. LOT'S CAPTIVITY AND RESCUE (GENESIS 14)

G S L V J A B L X S T O Z O M
 O O W D B J K A V M T O L A T
 M D K R I O K P Q C M B K S S
 O O A Q P U N O I T R O P T E
 R M K E D E Z I H C L E M N I
 R K I E T G A P D Z O U F A R
 A D J N V F G O O D S L K V P
 H D S R R K T M I D D I S R X
 U M E L A S F O G N I K S E P
 E O U Y F E V I T P A C M S C
 C K D E S S E L B L E P D T D
 N W O M E N W A V U M M A M T
 A S P H A L T P I T S C E Z X
 Q Q E Y E D E N I W X C R J X
 L K A D E L P O E P N V B S G

ABRAM	GOODS	PRIEST	ASPHALT PITS
KING OF	SALEM	SERVANTS	BLESSED
LOT	SIDDIM	BREAD	MELCHIZEDEK
SODOM	CAPTIVE	PEOPLE	WINE
GOMORRAH	PORTION	WOMEN	

WRITE DOWN THE LETTERS AS YOU COME TO THEM ON THE LINES BELOW

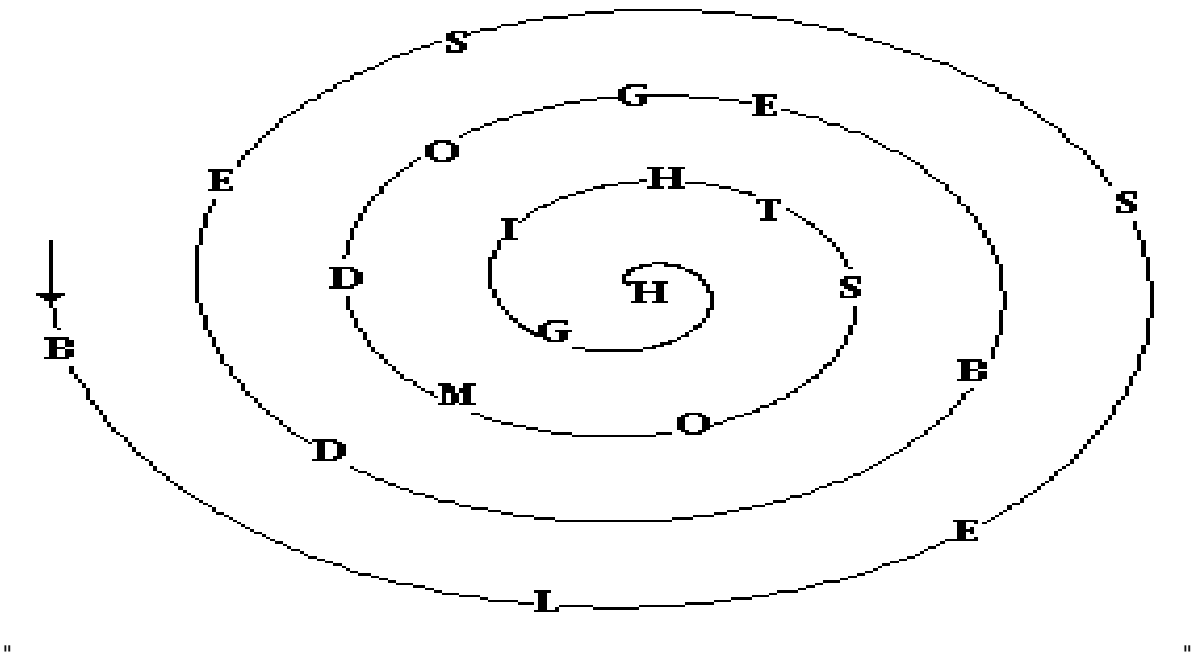

14. LOT'S CAPTIVITY AND RESCUE

(GENESIS 14)

MEMORY VERSE:

"Blessed be God Most High who has delivered your enemies into your hand."
GENESIS 14:20

FILL IN THE BLANKS:

1. "The king of _____, the king of _____, the king of Admah, the king of Zeboiim, and the king of Bela (that is Zoar) went out and joined together in _____ in the Valley of Siddim." **GENESIS 14:8**
2. "Now the Valley of Siddim was full of asphalt pits; and the kings of Sodom and Gomorrah _____; some fell there, and the remainder _____ to the mountains." **GENESIS 14:10**

TRUE OR FALSE:

3. "Then they took all the goods of Sodom and Gomorrah, and all their provisions, and went their way." **GENESIS 14:11**

TRUE OR FALSE

FILL IN THE BLANKS:

4. "They also took Lot, Abram's brother's son who _____ in Sodom, and his goods, and departed." **GENESIS 14:12**
5. "Now when Abram heard that his brother was taken captive, he armed his three hundred and eighteen trained servants who were born in his own house, and went in _____ as far as Dan." **GENESIS 14:14**

TRUE OR FALSE:

6. But he did not bring back any of the goods, neither did he bring back his brother Lot or his goods, neither the women nor any of the people. **GENESIS 14:16**

TRUE OR FALSE

FILL IN THE BLANKS:

7. "Then Melchizedek king of Salem brought out bread and wine; he was the _____ of God Most High. And he blessed him." **GENESIS 14:18-19**
8. And Abram "gave him a _____ of all." **GENESIS 14:20**

14. LOT'S CAPTIVITY AND RESCUE

(GENESIS 14)

O Y I J G E B Y Q I O A P S B Z Q C K D B C C R F
 U Q M F O P J A Y T J Z F L W S F D M F O H G T T
 O M W E P X O A U R D N H J Q P A R M I M I H H N
 C A S T L O N K J A Z T T G I B D B K J N U E N R
 C C H F S A R E T D S B A E Z S E N I W B S U A S
 K G S C R X S T A J A P K A O W N Q F Z E E E J K
 Y J C X P T O F I J S Q H D J N X T M X L R L E Z
 D H O T H M T C O O B X O A R K S Y K E P V P X Q
 D W N B K K Y O W G N M T S L S D P P G O A M I C
 U F V E E U P I X Z N V J I Q T D W M Y E N I K K
 M R V L H A I R R P D I P D T A P O V S P T J H H
 A B R A M B M Z I A V Z K D V V Y I O V U S L C D
 Y P D X R J X Z E E J C V I X I Q A T G M E S O S
 Z U O U Z J T R K D S A B M U E T W D S E C Q T B
 J D J F Q B B T Y Q R T Z R Z D Q F Q N L G O N J
 V V P I Q U N E J W H Q U C N Y I L U H C M Y D V
 U U V Q A Z E F W T D U P X Z N R L G U H V Q J A
 H B R V J R M H F F L E L E I X H F S M I E F L I
 B D X Q W S O N C O S R S F O Y D H Z B Z F T B C
 O I Y F M K W A L G G B T S U M H N G X E E H O I
 V Q T I Q A P E Q B V E E Q E A Z S U W D J N D N
 B C O I S T X M L K O S H Y E L W C G C E R V K S
 E D L G I L L M J H Q Z S R U A B A N S K L R W G
 E Q D V M X M T D G O M O R R A H V N H C W T Z C
 M T E D Z D P F O N B U B V M P V N H I K D O Y J

ABRAM
KING OF
LOT
SODOM
GOMORRAH

GOODS
SALEM
SIDDIM
CAPTIVE
PORTION

PRIEST
SERVANTS
BREAD
PEOPLE
WOMEN

ASPHALT PITS
BLESSED
MELCHIZEDEK
WINE

WRITE DOWN THE LETTERS AS YOU COME TO THEM ON THE LINES BELOW

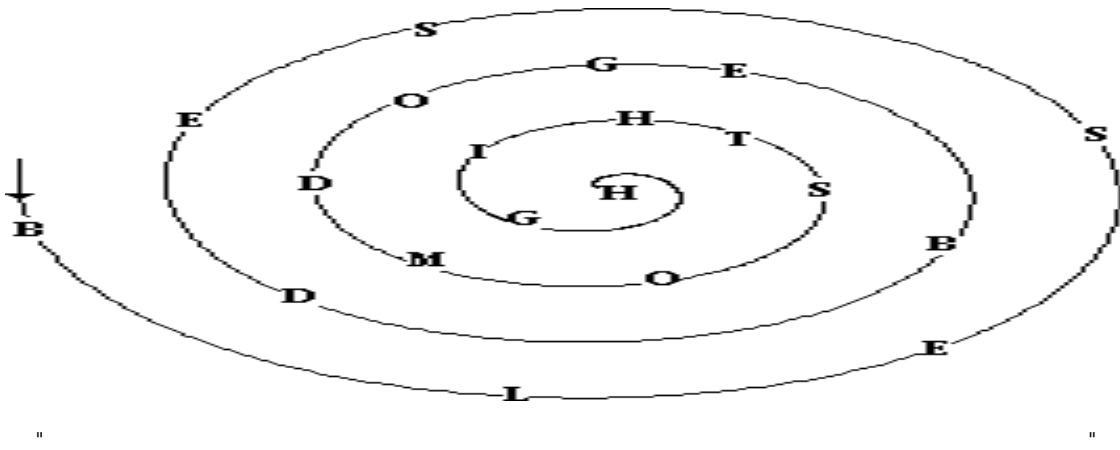

14. LOT'S CAPTIVITY AND RESCUE

(GENESIS 14)

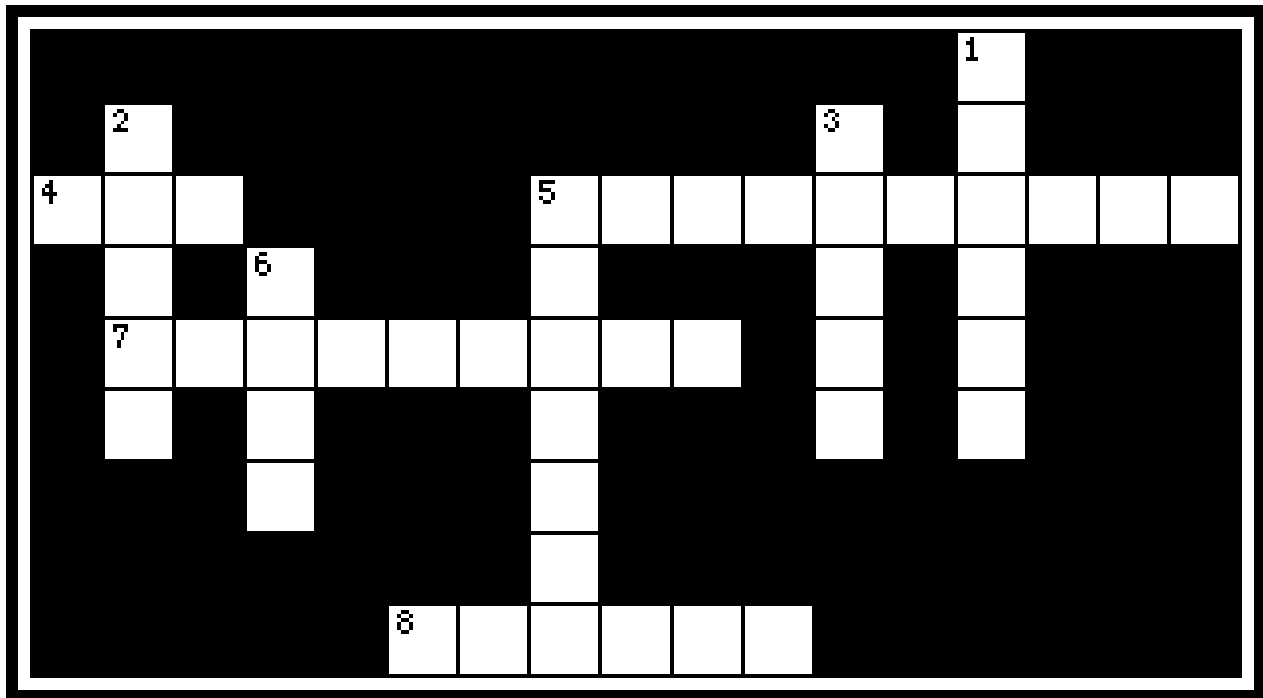

- 7 ACROSS "Blessed be God Most High who has _____ your enemies into your hand." **GENESIS 14:20**
- 8 ACROSS "The king of Sodom, the king of Gomorrah, the king of Admah, the king of Zeboim, and the king of Bela (that is Zoar) went out and joined together in _____ in the Valley of Siddim." **GENESIS 14:8**
- 6 DOWN "Now the Valley of Siddim was full of asphalt pits; and the kings of Sodom and Gomorrah _____; some fell there, and the remainder fled to the mountains." **GENESIS 14:10**
- 5 ACROSS "Then they took all the goods of Sodom and Gomorrah, and all their _____ and went their way." **GENESIS 14:11**
- 4 ACROSS "They also took _____, Abram's brother's son who dwelt in Sodom, and his goods, and departed." **GENESIS 14:12**
- 5 DOWN "Now when Abram heard that his brother was taken captive, he armed his three hundred and eighteen trained servants who were born in his own house, and went in _____ as far as Dan." **GENESIS 14:14**
- 2 DOWN "So he brought back all the _____, and also brought back his brother Lot and his goods, as well as the women and the people." **GENESIS 14:16**
- 1 DOWN "Then Melchizedek king of Salem brought out bread and wine; he was the _____ of God Most High. And he blessed him." **GENESIS 14:18-19**
- 3 DOWN And Abram "gave him a _____ of all." **GENESIS 14:20**

Bible Story 15

**GOD MAKES A
PROMISE
TO ABRAM**

GENESIS 15:1-17:19; 18:1-16

15. GOD MAKES A PROMISE TO ABRAM

(GENESIS 15:1-17:19; 18:1-16)



"And he brought him forth abroad, and said, Look now toward heaven, and tell the stars, if thou be able to number them: and he said unto him, So shall thy seed be."

GENESIS 15:5

15. GOD MAKES A PROMISE TO ABRAM

(GENESIS 15:1-17:19; 18:1-16)

MEMORY VERSE:

"For the promise that he would be the heir of the world was not to Abraham or to his seed through the law, but through the righteousness of faith." ROMANS 4:13

CIRCLE THE CORRECT WORDS:

1. "Abram said, 'Lord GOD, what will You give me, seeing I go (**CHILDLESS, SMILELESS**), and the heir of my house is Eliezer of Damascus?' " **GENESIS 15:2**
2. "And behold, the word of the LORD came to him, saying, 'This one shall not be your heir, but one who will come from your own body shall be your (**HAIR, HEIR**).' " **GENESIS 15:4**

TRUE OR FALSE:

3. "Then He brought him outside and said, 'Look now toward heaven, and count the stars if you are able to number them.' And He said to him, 'So shall your descendants be.' " **GENESIS 15:5**
TRUE OR FALSE
4. "And he believed in the LORD, and He accounted it to him for righteousness." **GENESIS 15:6**
TRUE OR FALSE

FILL IN THE BLANKS:

5. "On the same day the LORD made a covenant with Abram, saying: 'To your descendants _____
_____ this land, from the river of Egypt to the great river, the River Euphrates.'" **GENESIS 15:18-19**

TRUE OR FALSE

6. "When Abram was ninety-nine years old, the LORD appeared to Abram and said to him, 'I am Almighty God; walk before Me and be blameless.' " **GENESIS 17:1**
TRUE OR FALSE

CIRCLE THE CORRECT WORDS:

7. "As for Me, behold, My covenant is with you, and you shall be a (**FATHER, BROTHER**) of many nations. No longer shall your name be called Abram, but your name shall be called (**ABE, ABRAHAM**); for I have made you a father of (**FEW, MANY**) nations.' " **GENESIS 17:4-5**
8. "Also I give to you and your descendants after you the (**OCEAN, LAND**) in which you are a stranger, all the land of Canaan, as an everlasting possession; and I will be their God." **GENESIS 17:8**
"THEN THE LORD APPEARED TO HIM BY THE TEREBINTH TREES OF MAMRE, AS HE WAS SITTING IN THE TENT DOOR IN THE HEAT OF THE DAY." GENESIS 18:1
9. "And He said, 'I will certainly return to you according to the time of life, and behold, Sarah your wife shall have a (**HEADACHE, SON**).' " **GENESIS 18:10**
10. "And the LORD said to Abraham, 'Why did Sarah (**LAUGH, CRY**), saying, "Shall I surely bear a child, since I am (**YOUNG, OLD**)' Is there anything too (**HARD, EASY**) for the LORD? At the appointed time I will return to you, according to the time of life, and Sarah shall have a son.' " **GENESIS 18:13-14**

15. GOD MAKES A PROMISE TO ABRAM

(GENESIS 15:1-17:19; 18:1-16)

C O V E N A N T S T A R S H D
T Y M H Z K W H B N I E E F
O M S J W G A L O B V A S L P
Y S S E L D L I H C V C B F T
T R S L W P S A W E E S U W D
T A M X V I M O N N G G R U R
R U O B V E R Z D T U Y N U A
E V K K H D I A E D K M I Y W
B W I N W I N Y W P J A N O E
M A N P S T H E P T W R G L R
U T G F S N E H E I R B T P S
N Z O L R A R K E C S A O Z A
G V V H O V I G L P F M R P W
F K E J V R T Z S N Z X C Z I
I B N K B I D S G B Z O H X L

ABRAM
INHERIT
STARS
DESCENDANTS

HEIR
SMOKING OVEN
COVENANT
REWARD

SLEEP
CHILDLESS
NUMBER
WORD

BURNING TORCH
LORD
VISION
HEAVEN



"Then He brought him outside and said, 'Look now toward heaven, and count the stars if you are able to number them.' And He said to him, 'So shall your descendants be.' "

GENESIS 15:5

15. GOD MAKES A PROMISE TO ABRAM

(GENESIS 15:1-17:19; 18:1-16)

MEMORY VERSE:

"For the promise that he would be the heir of the world was not to Abraham or to his seed through the law, but through the righteousness of faith." ROMANS 4:13

CIRCLE THE CORRECT WORDS:

1. "Abram said, 'Lord GOD, what will You give me, seeing I go (**CHILDLESS, SMILELESS**), and the heir of my house is Eliezer of Damascus?' " **GENESIS 15:2**
2. "And behold, the word of the LORD came to him, saying, 'This one shall not be your heir, but one who will come from your own body shall be your (**HAIR, HEIR**).' " **GENESIS 15:4**

FILL IN THE BLANKS:

3. "Then He brought him outside and said, 'Look now toward heaven, and count the _____ if you are able to number them.' And He said to him, 'So shall your _____ be.' " **GENESIS 15:5**
4. "And he believed in the LORD, and He accounted it to him for _____." **GENESIS 15:6**
5. "On the same day the LORD made a covenant with Abram, saying: 'To your descendants _____ this land, from the river of Egypt to the great river, the River Euphrates.' " **GENESIS 15:18-19**

TRUE OR FALSE

6. "When Abram was ninety-nine years old, the LORD appeared to Abram and said to him, 'I am Almighty God; walk before Me and be blameless.' " **GENESIS 17:1**
TRUE OR FALSE

FILL IN THE BLANKS:

7. "As for Me, behold, My covenant is with you, and you shall be a _____ of many nations. No longer shall your name be called Abram, but your name shall be called _____; for I have made you a father of many nations.' " **GENESIS 17:4-5**
8. "Also I give to you and your descendants after you the _____ in which you are a stranger, all the land of Canaan, as an everlasting possession; and I will be their God." **GENESIS 17:8**

"THEN THE LORD APPEARED TO HIM BY THE TEREBINTH TREES OF MAMRE, AS HE WAS SITTING IN THE TENT DOOR IN THE HEAT OF THE DAY." GENESIS 18:1

TRUE OR FALSE

9. "And He said, 'I will certainly return to you according to the time of life, and behold, Sarah your wife shall have a son.' " **GENESIS 18:10**
TRUE OR FALSE

CIRCLE THE CORRECT WORDS:

10. "And the LORD said to Abraham, 'Why did Sarah (**LAUGH, CRY**), saying, "Shall I surely bear a child, since I am (**YOUNG, OLD**)' Is there anything too (**HARD, EASY**) for the LORD? At the appointed time I will return to you, according to the time of life, and Sarah shall have a son.' " **GENESIS 18:13-14**

15. GOD MAKES A PROMISE TO ABRAM

(GENESIS 15:1-17:19; 18:1-16)

G Z C E H P U S E D D E P E M D P U J E
 Z T I R E H N I P O Q J A M S R A T S A
 J F M J Z J D U T K E O T X O T P A Y Y
 P P L K Y P E E L S N U X N A X U V T U
 N N U M B E R H C Q R G V N A X Z X H H
 U G N E V O G N I K O M S R T N V O G A
 O K B K N H S P S K Y F I O V G E U F E
 F B X P J Q J E C L Y E Q B I E F V Y C
 L U A Z T O H V H W H K D U S I R V O N
 L K C Y P A Q A U K D D V L I K D Z Q C
 O C W Y L W O R E I J B S P O X R A D A
 R H C R O T G N I N R U B M N S O U A I
 D U J O J N E V A E H K M C M S W E B Z
 G M U J C V E L C J I K C C Z E K F R S
 O D K F V M W W N S P A Z V J L K P A N
 D L O A T F E J Q U T T L Z S D Y T M C
 D E S C E N D A N T S W U K M L R O C Z
 L S I H W S B U L E V L T F X I G N M X
 M V D R A W E R K A R A M K P H I I P R
 S R T A H W K O D V F P O S C C K J O P

ABRAM	HEIR	SLEEP	BURNING TORCH
INHERIT	SMOKING OVEN	CHILDLESS	LORD GOD
STARS	COVENANT	NUMBER	VISION
DESCENDANTS	REWARD	WORD	HEAVEN

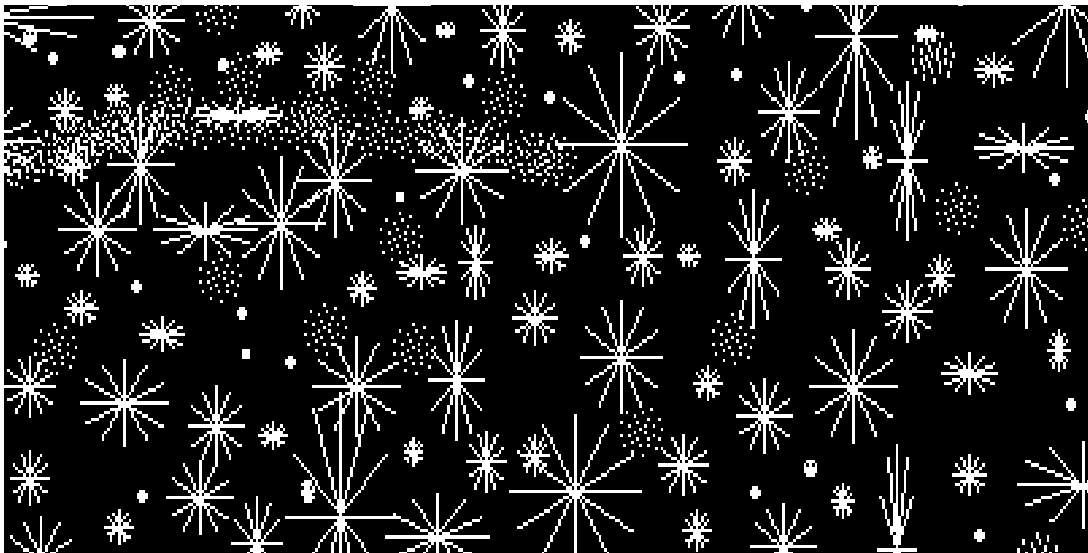

"Then He brought him outside and said, 'Look now toward heaven, and count the stars if you are able to number them.' And He said to him, 'So shall your descendants be.' "
 GENESIS 15:5

15. GOD MAKES A PROMISE TO ABRAM

(GENESIS 15:1-17:19; 18:1-16)

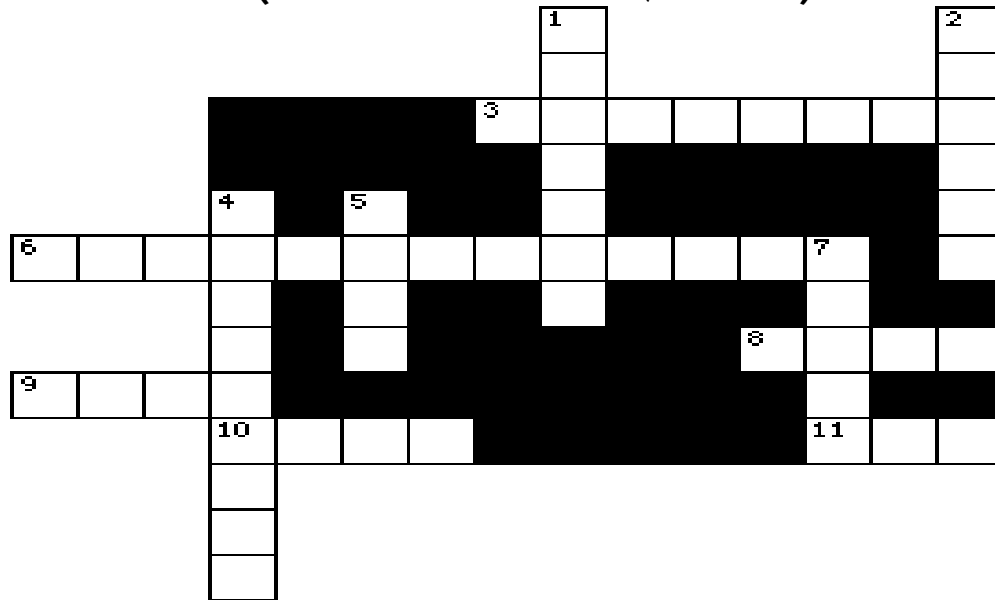

- 1 DOWN "For the ____ that he would be the heir of the world was not to Abraham or to his seed through the law, but through the righteousness of faith." **ROMANS 4:13**
- 4 DOWN "Abram said, 'Lord GOD, what will You give me, seeing I go _____, and the heir of my house is Eliezer of Damascus?'" **GENESIS 15:2**
- 5 DOWN "And behold, the word of the LORD came to him, saying, 'This one shall not be your heir, but one who will come from your own body shall be your _____'" **GENESIS 15:4**
- 7 DOWN "Then He brought him outside and said, 'Look now toward heaven, and count the ____ if you are able to number them.' And He said to him, 'So shall your descendants be.'" **GENESIS 15:5**
- 6 ACROSS "And he believed in the LORD, and He accounted it to him for _____" **GENESIS 15:6**
- 3 ACROSS "On the same day the LORD made a _____ with Abram, saying: 'To your descendants I have given this land, from the river of Egypt to the great river, the River Euphrates.'" **GENESIS 15:18-19**
- 8 ACROSS "When Abram was ninety-nine years old, the LORD appeared to Abram and said to him, 'I am Almighty God; _____ before Me and be blameless.'" **GENESIS 17:1**
- 2 DOWN "As for Me, behold, My covenant is with you, and you shall be a _____ of many nations. No longer shall your name be called Abram, but your name shall be called Abraham; for I have made you a father of many nations.'" **GENESIS 17:4-5**
- 10 ACROSS "Also I give to you and your descendants after you the _____ in which you are a stranger, all the land of Canaan, as an everlasting possession; and I will be their God." **GENESIS 17:8**
- 11 ACROSS "And He said, 'I will certainly return to you according to the time of life, and behold, Sarah your wife shall have a _____.'" **GENESIS 18:10**
- 9 ACROSS "And the LORD said to Abraham, 'Why did Sarah laugh, saying, "Shall I surely bear a child, since I am old" Is there anything too _____ for the LORD?'" **GENESIS 18:13-14**

Bible Story 16

HAGAR AND ISHMAEL

GENESIS 16

16. HAGAR AND ISHMAEL (GENESIS 16)



"And the angel of the LORD found her by a fountain of water in the wilderness, by the fountain in the way to Shur. And he said, Hagar, Sarai's maid, whence camest thou? And whither wilt thou go? And she said, I flee from the face of my mistress Sarai."

GENESIS 16:7-8

16. HAGAR AND ISHMAEL

(GENESIS 16)

MEMORY VERSE:

"Then she called the name of the LORD who spoke to her, You-Are-the-God-Who-Sees; for she said, 'Have I also here seen Him who sees me?' " GENESIS 16:13

CIRCLE THE CORRECT WORDS:

1. "Now Sarai, Abram's wife, had borne him no children. And she had an Egyptian maidservant whose name was (**HAG, HAGAR**). " GENESIS 16:1
2. "Sarai said to Abram, 'I have become (**DESPISED, LOVED**) in her eyes.' " GENESIS 16:5

FILL IN THE BLANK:

3. "So Abram said to Sarai, 'Indeed your maid is in your hand; do to her as you please.' And when Sarai dealt harshly with her, she _____ from her presence." GENESIS 16:6

UNDERLINE THE ALL THE CORRECT ANSWERS:

4. "Now the Angel of the LORD found her..." GENESIS 16:7

**BY A SPRING OF WATER IN THE WILDERNESS
UNDERNEATH A TREE
BY THE SPRING ON THE WAY TO SHUR**

TRUE OR FALSE:

5. "The Angel of the LORD said to her, 'Return to your mistress, and submit yourself under her hand.' " GENESIS 16:9
TRUE OR FALSE
6. "Then the Angel of the LORD said to her, 'I will multiply your descendants exceedingly, so that they shall not be counted for multitude.' " GENESIS 16:10
TRUE OR FALSE

7. **CIRCLE T or F** "And the Angel of the LORD said to her:..." GENESIS 16:11-12

- | | | |
|--|---|---|
| * Behold, you are with child | T | F |
| * And you shall bear a son | T | F |
| * You shall call his name Ishmael | T | F |
| * The LORD has not heard your affliction | T | F |
| * He shall be a mild man | T | F |
| * His hand shall be against every man and every man's hand against him | T | F |
| * He shall dwell in the presence of all his brethren | T | F |

16. HAGAR AND ISHMAEL

(GENESIS 16)

A T H E G O D W H O S E E S M
 I N V T W M E U Y M Y G S U A
 E A G I I L P S N J M Y J S I
 Y Q L E L M J Y M L T P L A D
 D D S M L N B J Q P G T P R S
 E A E U A O H U P O N I B A E
 S O T H B Q F G S L I A N I R
 C Y K A R R D T L T R N S I V
 E E N G A U N A H P P S L C A
 N A B A M M O K J E S F P C N
 D E Y R K E S R D N L M L M T
 A D E S I P S E D R F O H E G
 N Q Z E G S C B D A H C R R D
 T U I S H M A E L P D U L D B
 S T A D C Z U N R L R R Q X I

ABRAM
 ISHMAEL
 THE GOD WHO SEES
 EGYPTIAN

HAGAR
 SUBMIT
 DESPISED
 SON

SPRING
 DESCENDANTS
 SARAI
 WILD

ANGEL OF THE LORD
 MAIDSERVANT
 WELL
 FLED

WRITE DOWN THE LETTERS AS YOU COME TO THEM ON THE LINES BELOW

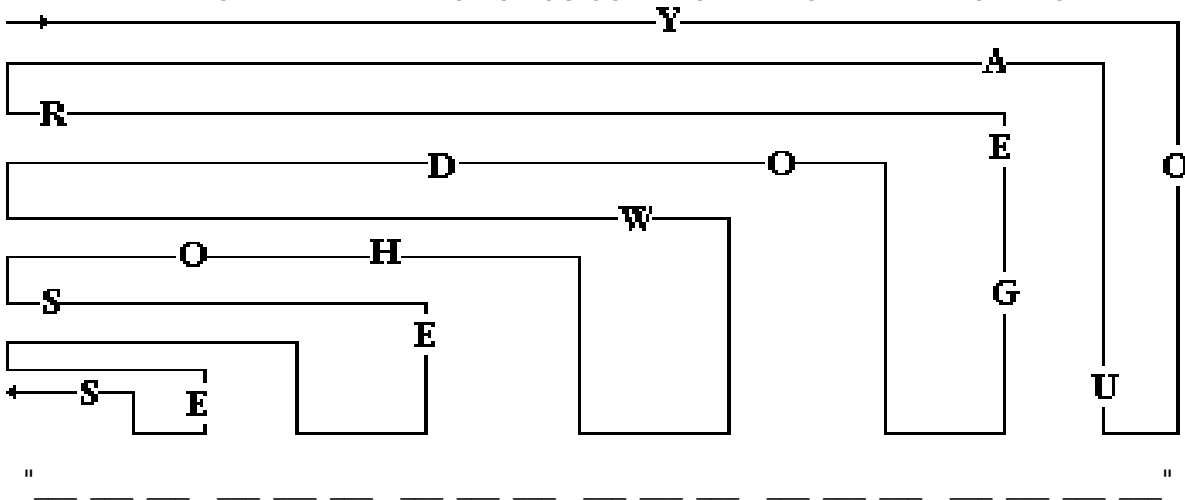

16. HAGAR AND ISHMAEL

(GENESIS 16)

MEMORY VERSE:

"Then she called the name of the LORD who spoke to her, You-Are-the-God-Who-Sees; for she said, 'Have I also here seen Him who sees me?'" GENESIS 16:13

FILL IN THE BLANKS:

1. "Now Sarai, Abram's wife, had borne him no children. And she had an Egyptian maidservant whose name was _____." **GENESIS 16:1**
2. "Sarai said to Abram, 'My _____ be upon you! I gave my maid into your embrace; and when she saw that she conceived, I became _____ in her eyes.'" **GENESIS 16:5**
3. "So Abram said to Sarai, 'Indeed your maid is in your hand; do to her as you please.' And when Sarai dealt harshly with her, she _____ from her presence." **GENESIS 16:6**

UNDERLINE THE ALL THE CORRECT ANSWERS:

4. "Now the Angel of the LORD found her..." **GENESIS 16:7**

**BY A SPRING OF WATER IN THE WILDERNESS
UNDERNEATH A TREE
BY THE SPRING ON THE WAY TO SHUR**

TRUE OR FALSE:

5. "The Angel of the LORD said to her, 'Return to your mistress, and submit yourself under her hand.'" **GENESIS 16:9**
TRUE OR FALSE
6. "Then the Angel of the LORD said to her, 'I will multiply your descendants exceedingly, so that they shall not be counted for multitude.'" **GENESIS 16:10**
TRUE OR FALSE

FILL IN THE BLANKS:

7. "And the Angel of the LORD said to her:..." **GENESIS 16:11-12**
 - * Behold, you are with _____
 - * And you shall bear a _____
 - * You shall call his name _____
 - * The LORD has heard your _____
 - * He shall be a _____ man
 - * His hand shall be _____ every man and every man's hand _____ him
 - * He shall _____ in the presence of all his brethren

16. HAGAR AND ISHMAEL

(GENESIS 16)

D N F F J N O E W P L K C H E I T X I P K Z E R P
 E G H H B R F A U N S P V Q P J V V B S X A A P G
 S X P A B P V W F U V Z T O T S R Q U C H U Y J C
 C G J W R I X L I O R Y W E C U F D L D P M N P J
 E R T X B Q S Z X F C Y H W S E E V P T P E A Q N
 N Q B P K D V X G L M T I M B U S S M X U F I E H
 D I I E E J M P Y L L O P E C A J M C D Z P T X L
 A P A T N A V R E S D I A M H V O C C E V T P Q E
 N H M S F Q A J P M B J J B U D U Z V S F O Y F D
 T Z X G J R Z H Y S X F H K E Q G L Z P R N G G B
 S I T D T D S G B Z A A Q S C E F U K I K I E A Y
 R V Y E E L O E D F C H O U N N K T F S K J U M K
 E V L P J I N U R P W A A H Q R D M K E Y J H M K
 U B I Z Z W S W C G J H W P L Y B O S D R Y A A J
 W Q S E E S O H W D O G E H T E R A U O Y T E O M
 J Y O C Z I H D G K U Z V E K Y K E M G G H C K V
 N E V C K L M W D E L F M V D D K M O N I G N C W
 S L Q Q M A R B A B K Y F A D J A X A I K F A Y Z
 Z N Z I C S X Y R U O N S R O R T I T R U Y I U W
 K V U W T T S P G K I J W L K A W A M P A Q Z D E
 A N G E L O F T H E L O R D Q G L R Z S V D S Y L
 B Q A Z I F V Z N C T T U W K A A A J X X C N G L
 Z T N K O A O W G U E P D J L H P S S G O M C T F
 F A M K T Y J B Z M J L S U W I P N M E U P Z I I
 H Q G Q A Y J M J D K J J O K P A O X I V O X I Z

- | | | | |
|----------|----------|-------------|--------------------------|
| ABRAM | HAGAR | SPRING | ANGEL OF THE LORD |
| ISHMAEL | SUBMIT | DESCENDANTS | MAIDSERVANT |
| WELL | DESPISED | SARAI | WILD |
| EGYPTIAN | SON | FLED | YOU ARE THE GOD WHO SEES |

WRITE DOWN THE LETTERS AS YOU COME TO THEM ON THE LINES BELOW

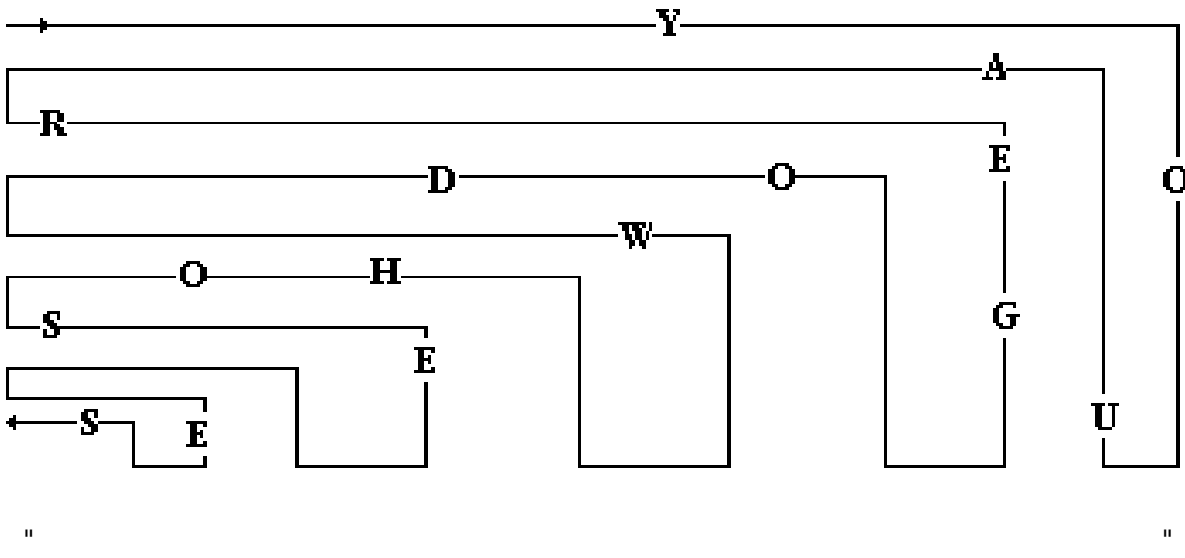

16. HAGAR AND ISHMAEL (GENESIS 16)

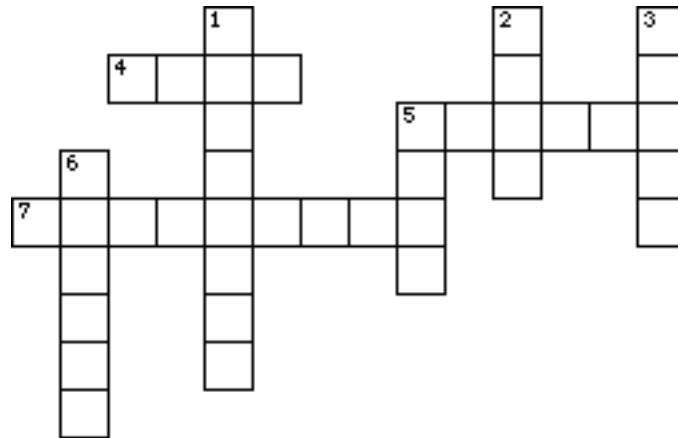

- 5 DOWN "Then she called the name of the LORD who spoke to her, You-Are-the-God-Who-Sees; for she said, 'Have I also here seen Him who _____me?' " **GENESIS 16:13**
- 3 DOWN "Now Sarai, Abram's wife, had borne him no children. And she had an Egyptian maidservant whose name was _____." **GENESIS 16:1**
- 1 DOWN "Sarai said to Abram, 'I have become _____ in her eyes.'" **GENESIS 16:5**
- 4 ACROSS "So Abram said to Sarai, 'Indeed your maid is in your hand; do to her as you please.' And when Sarai dealt harshly with her, she _____ from her presence." **GENESIS 16:6**
- 5 ACROSS "Now the Angel of the LORD found her by a _____ of water in the wilderness, by the spring on the way to Shur." **GENESIS 16:7**
- 6 DOWN "The Angel of the LORD said to her, 'Return to your mistress, and _____ yourself under her hand.'" **GENESIS 16:9**
- 7 ACROSS "Then the Angel of the LORD said to her, 'I will multiply your descendants exceedingly, so that they shall not be counted for _____.'" **GENESIS 16:10**
- 2 DOWN "And the Angel of the _____ said to her, 'Behold, you are with child, and you shall bear a son. You shall call his name Ishmael, because the LORD has heard your affliction.'" **GENESIS 16:11**

Bible Story 17

**ABRAHAM
BARGAINS
WITH GOD**

GENESIS 18:16-33

17. ABRAHAM BARGAINS WITH GOD

(GENESIS 18:16-33)



"And he said, Oh let not the Lord be angry, and I will speak yet but this once: Peradventure ten shall be found there. And he said, I will not destroy it for ten's sake."

GENESIS 18:32

17. ABRAHAM BARGAINS WITH GOD

(GENESIS 18:16-33)

MEMORY VERSE:

"As righteousness leads to life, so he who pursues evil pursues it to his own death."
PROVERBS 11:19

TRUE OR FALSE:

1. "The LORD said, 'Shall I hide from Abraham what I am doing?' " **GENESIS 18:17**
TRUE OR FALSE

CIRCLE THE CORRECT WORDS:

2. "The LORD said, 'Because the outcry against Sodom and Gomorrah is (**GREAT, SMALL**), and because their sin is very (**LITTLE, GRIEVOUS**), I will go down now and see whether they have done altogether according to the outcry against it that has come to Me; and if not, I will know.' " **GENESIS 18:20-21**

TRUE OR FALSE:

3. "Then the men turned away from there and went toward Sodom, but Abraham still stood before the LORD." **GENESIS 18:22**
TRUE OR FALSE
4. "And Abraham came near and said, 'Would You also destroy the righteous with the wicked?' " **GENESIS 18:23**
TRUE OR FALSE

FILL IN THE BLANKS:

5. **THE LORD SAID... GENESIS 18:26-32**

If I find in Sodom _____ righteous within the city, then I will spare all the place for their sakes

(18:26) If I find there _____, I will not destroy it (18:28)

I will not do it for the sake of _____(18:29)

I will not do it if I find _____ there (18:30)

I will not destroy it for the sake of _____ (18:31)

I will not destroy it for the sake of _____(18:32)

CIRCLE THE CORRECT WORD:

6. "So the LORD went His way as soon as He had finished (**SPEAKING, FISHING**) with Abraham; and Abraham returned to his place." **GENESIS 18:33**

17. ABRAHAM BARGAINS WITH GOD

(GENESIS 18:16-33)

K Q T W N J G T H H V L O R D
 S P R K S I F O R T Y F I V E
 M M R B B U S O G K C Q V Z U
 J N A I A W O T H I R T Y O F
 S A W H P R W E D K C N Y A L
 A Y P E A S G M T Y T R O F Y
 K Q Y T P R H A V H H Y K K H
 E U N T W S B A I Y G M W U X
 T D K P F E A A R N R I L N O
 A Q E I Y I N J B R E C R U I
 A T B S S I F T G S O D T D R
 U N E T T P F K Y R O M W U F
 E H C Y F R A G C E R D O L O
 W I C K E D O R Z N E A O G Y
 N T D B O A U Y E C M S W M X

ABRAHAM
 BARGAINED
 DESTROY
 FIFTY
 FORTY-FIVE
 FORTY

GOMORRAH
 LORD
 OUTCRY
 RIGHTEOUS
 SAKE
 SIN

SODOM
 SPARE
 TEN
 THIRTY
 TWENTY
 WICKED

WRITE DOWN THE LETTERS IN THE BOXES AS YOU COME TO THEM ON THE LINES BELOW

→	R		I			L		E				L
	T							A				I
		H		G	S	S				F		
	E							D	E		O	
			O		E		N			S		
			U			S				T		

17. ABRAHAM BARGAINS WITH GOD

(GENESIS 18:16-33)

MEMORY VERSE:

"As righteousness leads to life, so he who pursues evil pursues it to his own death."

PROVERBS 11:19

TRUE OR FALSE:

1. "The LORD said, 'Shall I hide from Abraham what I am doing?' " **GENESIS 18:17**

TRUE OR FALSE

FILL IN THE BLANKS:

2. "The LORD said, 'Because the outcry against Sodom and Gomorrah is _____, and because their _____ is very _____, I will go down now and see whether they have done altogether according to the outcry against it that has come to Me; and if not, I will know.' "

GENESIS 18:20-21

TRUE OR FALSE:

3. "Then the men turned away from there and went toward Sodom, but Abraham still stood before the LORD." **GENESIS 18:22**

TRUE OR FALSE

4. "And Abraham came near and said, 'Would You also destroy the righteous with the wicked?' " **GENESIS 18:23**

TRUE OR FALSE

MATCHING:

5. **DRAW A LINE TO CONNECT THE THINGS THE LORD WILL DO IF HE SHOULD FIND RIGHTEOUS PEOPLE IN SODOM:**

THE LORD SAID...

THEN...

If I find in Sodom fifty righteous (18:26)

for the sake of forty

If I find there forty-five (18:28)

for the sake of twenty

I will not do it (18:29)

if I find thirty there

I will not do it (18:30)

I will spare all the place for their sakes

I will not destroy it (18:31)

for the sake of ten

I will not destroy it (18:32)

I will not destroy it

FILL IN THE BLANK:

6. "So the LORD went His way as soon as He had finished _____ with Abraham; and Abraham returned to his place." **GENESIS 18:33**

17. ABRAHAM BARGAINS WITH GOD (GENESIS 18:16-33)

G S Q B A V Q N K G K W I U S S W J T V P V V B A
 S P I Q Z I C A I W R L R U E O I F J U Z K E K C
 N P L J E O U Y Y A E W F A J T U Y Y B F U V J L
 B R H I M R J Q S T N A B R A H A M R N B O V K P
 K X Y C D N I O E F N W Y D M W M T D H X Z L U A
 K O T T W H D G P U C E L O R D F Y T R O F A M I
 O S Y T I O K U H T V Z W D G I O W Y O R T S E D
 J L O C M H S Q I T C O X T O H E U C X K X I X E
 Q K A J Q I T T Y O E A D W V J F G G A M A L Y Y
 S W V W X U M H B M C O F T S D O H S H Z M R R A
 P V C Y S P A R E E J Y K U L P U R X Q A X Z U T Q
 M J A J I A J T B K H R B S T O T V U R I B U T A
 B X L T T F E T P G R U C A W L Y S M R Z T C C O
 B W F N A F K R P H E N E T B O F U J O F P Q M Y
 O E O I L T A B Y G M U H O U U I X Q M Z Z N P E
 H L Z A F Q S R A D Q D T A H O V H L O X F R M A
 S V M S B T T W F R N L L P J I E U J G D V P L E
 S D F L Z H Y P O V G U U A Y I D Q T U K F L C Q
 R D M P Z A A N J B Y A W D K B E T W V X H B S U
 V Z Q U N U A K W G M F I Y P R K P K A U N I G T
 N Z S T K U U N S C A L Q N G W C L M E Y E F E V
 G O Q N O T E B I Z S Y N S E G I J L I E E W Y S
 D W V D B T N C S S V H I M K D W B U S E M L U E
 P T E N H D Q D I H Y X S U G T P J G G J J J W T
 K H P R F D X W A K K O V X P K K H C J A Q B I K

ABRAHAM
 BARGAINED
 DESTROY
 FIFTY
 FORTY-FIVE
 FORTY

GOMORRAH
 LORD
 OUTCRY
 RIGHTEOUS
 SAKE
 SIN

SODOM
 SPARE
 TEN
 TWENTY
 WICKED

WRITE DOWN THE LETTERS IN THE BOXES AS YOU COME TO THEM ON THE LINES BELOW

→	R		I			L		E				L
	T							A				I
		H		G	S	S				F		
	E							D	E			O
			O		E		N			S		
			U			S				T		

17. ABRAHAM BARGAINS WITH GOD

(GENESIS 18:16-33)

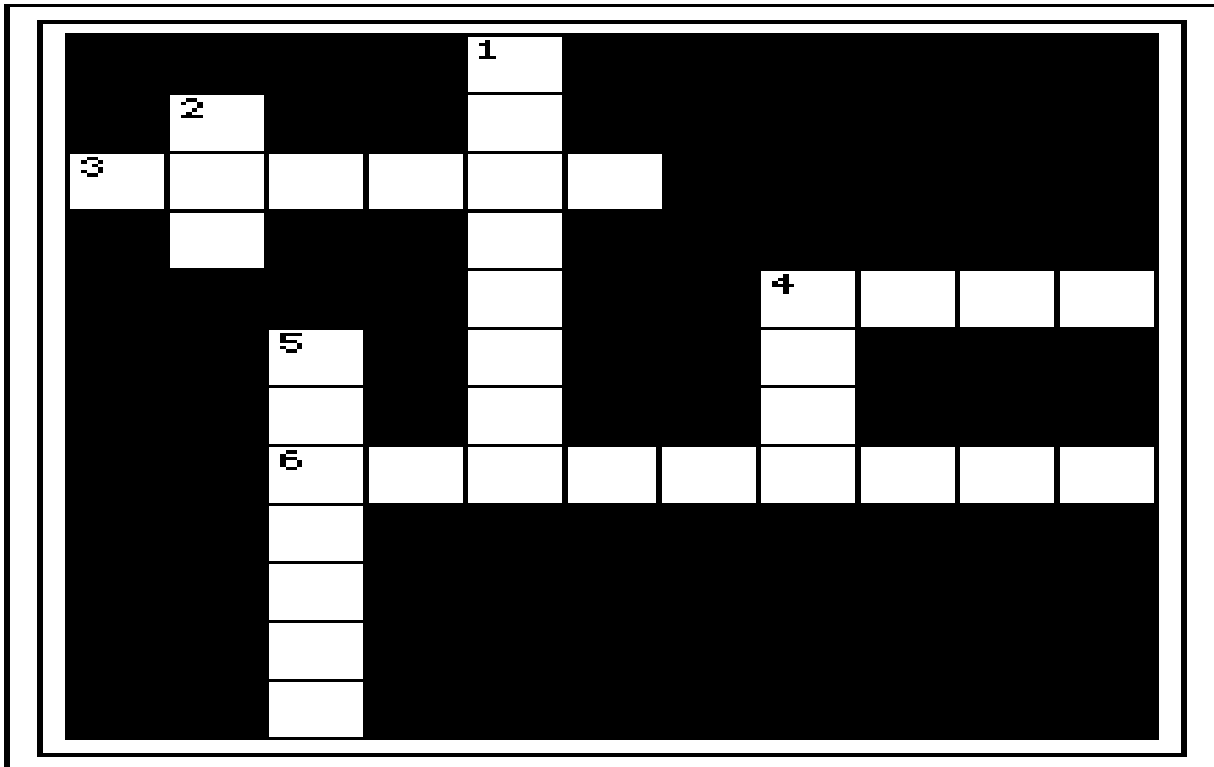

- 4 DOWN "As righteousness leads to _____, so he who pursues evil pursues it to his own death."
PROVERBS 11:19
- 5 DOWN "The LORD said, 'Shall I hide from _____ what I am doing?' " **GENESIS 18:17**
- 2 DOWN "The LORD said, 'Because the outcry against Sodom and Gomorrah is great, and because their _____ is very grievous, I will go down now and see whether they have done altogether according to the outcry against it that has come to Me; and if not, I will know.' " **GENESIS 18:20-21**
- 4 ACROSS "Then the men turned away from there and went toward Sodom, but Abraham still stood before the _____." **GENESIS 18:22**
- 3 ACROSS "And Abraham came near and said, 'Would You also destroy the righteous with the _____?' " **GENESIS 18:23**
- 6 ACROSS "And the LORD said, 'If I find in Sodom fifty _____ within the city, then I will spare all the place for their sakes.' " **GENESIS 18:26**
- 1 DOWN "So the LORD went His way as soon as He had finished _____ with Abraham; and Abraham returned to his place." **GENESIS 18:33**

Bible Story 18

SODOM & GOMORRAH

GENESIS 19:1-30

18. SODOM & GOMORRAH

(GENESIS 19:1-30)



"And it came to pass, when they had brought them forth abroad, that he said, Escape for thy life; look not behind thee, neither stay thou in all the plain; escape to the mountain, lest thou be consumed."

GENESIS 19:17

18. SODOM & GOMORRAH

(GENESIS 19:1-30)

MEMORY VERSE:

"The Lord knows how to deliver the godly out of temptations and to reserve the unjust under punishment for the day of judgment." 2 PETER 2:9

UNDERLINE THE CORRECT ANSWER:

1. "Now the two angels came to Sodom in the evening, and..." **GENESIS 19:1**
 - a. Lot was sitting in the gate of Sodom
 - b. when Lot saw them, he rose to meet them
 - c. he bowed himself with his face toward the ground
 - d. all of the above

TRUE OR FALSE:

2. "And he said, 'Here now, my lords, please turn in to your servant's house and spend the night, and wash your feet; then you may rise early and go on your way.' And they said, 'No, but we will spend the night in the open square.'" **GENESIS 19:2**

TRUE OR FALSE

3. So the two angels spent the night in the open square. **GENESIS 19:3**

TRUE OR FALSE

CIRCLE THE CORRECT WORDS:

4. "Now before they lay down, the men of the city, the men of Sodom, both old and young, all the people from every quarter, (**BUILT, SURROUNDED**) the house." **GENESIS 19:4**
5. "The men reached out their hands and pulled Lot into the house with them, and shut the (**WINDOWS, DOOR**)." **GENESIS 19:10**
6. "And they struck the men who were at the doorway of the house with (**BLINDNESS, DEAFNESS**), both small and great, so that they became weary trying to find the door." **GENESIS 19:11**

FILL IN THE BLANK:

7. "When the morning dawned, the angels urged Lot to _____, saying, 'Arise, take your wife and your two daughters who are here, lest you be consumed in the punishment of the city.'" **GENESIS 19:15**

TRUE OR FALSE:

8. "So it came to pass, when they had brought them outside, that he said, 'Escape for your life! Do not look behind you nor stay anywhere in the plain. Escape to the mountains, lest you be destroyed.'" **GENESIS 19:17**

TRUE OR FALSE

9. "Then the LORD rained brimstone and fire on Sodom and Gomorrah, from the LORD out of the heavens." **GENESIS 19:24**

TRUE OR FALSE

10. But Lot's wife looked back behind him, and she became a pillar of sand. **GENESIS 19:26**

TRUE OR FALSE

18. SODOM & GOMORRAH

(GENESIS 19:1-30)

B F E A S T K E D T M X V I Q
L D O O R K V G S J E T L D G
I Z H E R I F S T C N L E E N
N O D S M O K E L I A S R N I
D A S L E G N A O W T P R O N
N R E S U O H L V R A O E T E
E K F T N T E C O P Y A L S V
S O W E L O F Y E F I W E M E
S T L A S F O R A L L I P I P
U O Y F M H A R R O M O G R I
A P L U F I C R E M S A V B P
U S T R A C L Y P K G B T R O
D A U G H T E R S D M H U E R
T F S Y A N M O D O S P V F A
E D K R E D I S T U O U P V V

ATE
BLINDNESS
BRIMSTONE
DAUGHTERS
DESTROY
HOUSE

ESCAPE
EVENING
FEAST
FIRE
GOMORRAH
SMOKE

LOT
MEN
MERCIFUL
OUTSIDE
PILLAR OF SALT

SODOM
ZOAR
TWO ANGELS
WIFE
DOOR

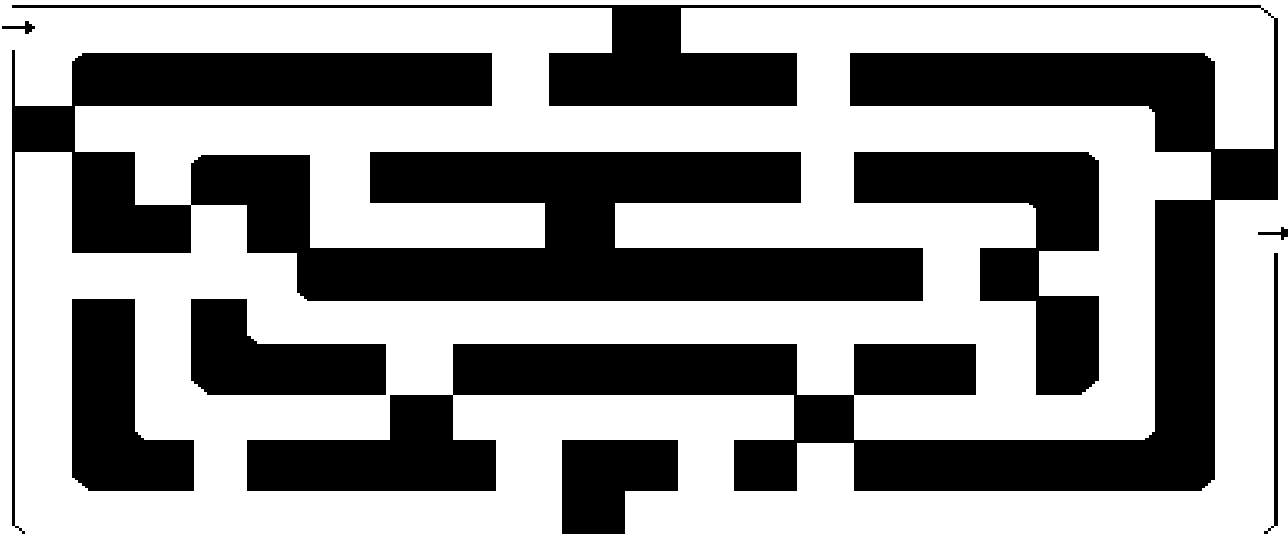

18. SODOM & GOMORRAH

(GENESIS 19:1-30)

MEMORY VERSE:

"The Lord knows how to deliver the godly out of temptations and to reserve the unjust under punishment for the day of judgment." 2 PETER 2:9

UNDERLINE THE CORRECT ANSWER:

1. "Now the two angels came to Sodom in the evening, and..." **GENESIS 19:1**
 - a. Lot was sitting in the gate of Sodom
 - b. when Lot saw them, he rose to meet them
 - c. he bowed himself with his face toward the ground
 - d. all of the above

TRUE OR FALSE:

2. "And he said, 'Here now, my lords, please turn in to your servant's house and spend the night, and wash your feet; then you may rise early and go on your way.' And they said, 'No, but we will spend the night in the open square.'" **GENESIS 19:2**

TRUE OR FALSE
3. So the two angels spent the night in the open square. **GENESIS 19:3**

TRUE OR FALSE

FILL IN THE BLANKS:

4. "Now before they lay down, the men of the city, the men of Sodom, both old and young, all the people from every quarter, _____ the house." **GENESIS 19:4**
5. "The men reached out their hands and pulled Lot into the house with them, and shut the _____." **GENESIS 19:10**
6. "And they struck the men who were at the doorway of the house with _____, both small and great, so that they became _____ trying to find the door." **GENESIS 19:11**
7. "When the morning dawned, the angels urged Lot to _____, saying, 'Arise, take your wife and your two daughters who are here, lest you be _____ in the punishment of the city.'" **GENESIS 19:15**
8. "So it came to pass, when they had brought them outside, that he said, 'Escape for your life! _____ look behind you nor stay anywhere in the plain. Escape to the _____ mountains, lest you be destroyed.'" **GENESIS 19:17**
9. "Then the LORD rained _____ and _____ on Sodom and Gomorrah, from the LORD out of the heavens." **GENESIS 19:24**
10. But Lot's wife "looked back behind him, and she became a pillar of _____." **GENESIS 19:26**
11. "And it came to pass, when God destroyed the cities of the plain, that God _____, and sent Lot out of the midst of the overthrow, when He overthrew the cities in which Lot had dwelt." **GENESIS 19:29**

18. SODOM & GOMORRAH

(GENESIS 19:1-30)

R W C I H A B D N L U O O H Q A U N F U V Q P C M S X D V R
V H T T A Y P V Y Y U V U X U E Y E W W S R L U R G Y O X X
N Q C A U Q P B M H A S I V M I E E L I E U J R X I A N R T
G I J L M U Y G A L S P I T W O A N G E L S D S G F E Z B P
D L W O U Q P C S T U T B S J S E M J A T M D J B L M F I K
P H D E T T F I R X D F R U Q G J J B C K E R L I B X N U Z
K O Y B K H O U L O D W I X L F I R E L T S A E F K Z X Q O
S T J Z T O C Z V L W B W C J J A Q B P N S M P E S U O H V
S Y T Z D K M H Y I A H G H R P V V K A B H A R R O M O G L
P O N N D T J S K R T R T U T E K E J I Y Z J B V M U A H C
P A A K Q T W K W F L J O Q W Z M V K E B P L N S I I D C Y
R V S O C R S K L Y A Y K F K F U V U Y R J P S M U J P C Y
X C L O T R S R W X O K Y T S B O L M A I H O R K X L U N P
O A L B U D O O R D A P W O M A Z A X Q M D L E I W M K U D
S L P H J W I R W F P G I P R X L I Y A S C T T R V P I K D
L O U F K P A A Z B A K U L L T X T R O T U P H K K X X S A
K Z E V S N G O B E D G M J U K S L T Y O U N G Q G E R U W
W M T V M K W Z O L Y P F B G M A E T E N S R U Y P C Q N Z
V F N I E B A E A H I S O J C Z M R D A E Y A A C H H I E C
J M D O J N F N K T S N E H V X Z U C E Z J P D Z K M J S P
X Q R N T C I C U L M O D E P A C S E E A G L S A H X L X Y
W S A H A D U N A U U T P N U I B U M D X A Y L K C I J T E
E Q Z I A W T V G T X W K T E Z T C P I U K M P R O V V I J
L V E U U K O C N W E I J J B S P Q M S E R T H V V M R L R
V P M A E I M C N Q S H F Y N F S N L T D B F L Z N T R E L
D B D F N E J H U E E J Y R H Z Z R C U K N H Q Y J Q K I P
D Q W F Q P K R D N M D T D X X F U S O G Y D U E L V J A P
Z W I F E I G E L I J U W C A D V K G Q C N R I H D U S K B
Z J Q T X Y H M U S M O U G U K F B E U M M S C Z R G F Q X
O I X Q N B G Q F V G L G S V X H I Y T N Q M C C Z B Q Y D

- | | | | |
|------------------|-----------------|-----------------------|-------------------|
| ATE | ESCAPE | LOT | SODOM |
| BLINDNESS | EVENING | MEN | STRUCK |
| BRIMSTONE | FEAST | MERCIFUL | TWO ANGELS |
| DAUGHTERS | FIRE | OUTSIDE | WIFE |
| DESTROY | GOMORRAH | PILLAR OF SALT | ZOAR |
| HOUSE | SMOKE | DOOR | |

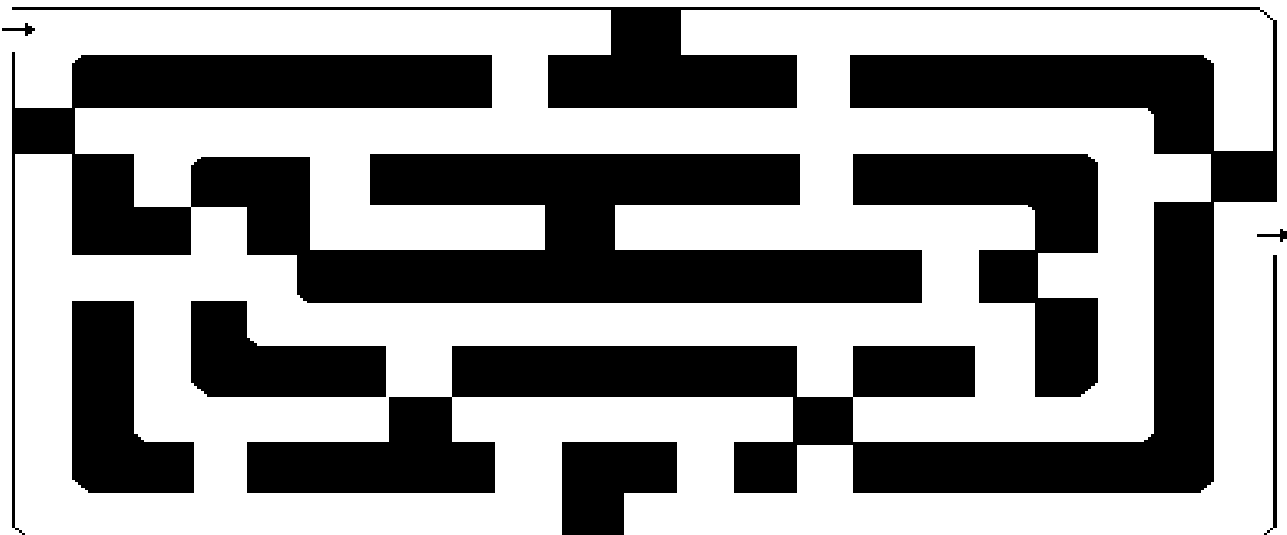

18. SODOM & GOMORRAH

(GENESIS 19:1-30)

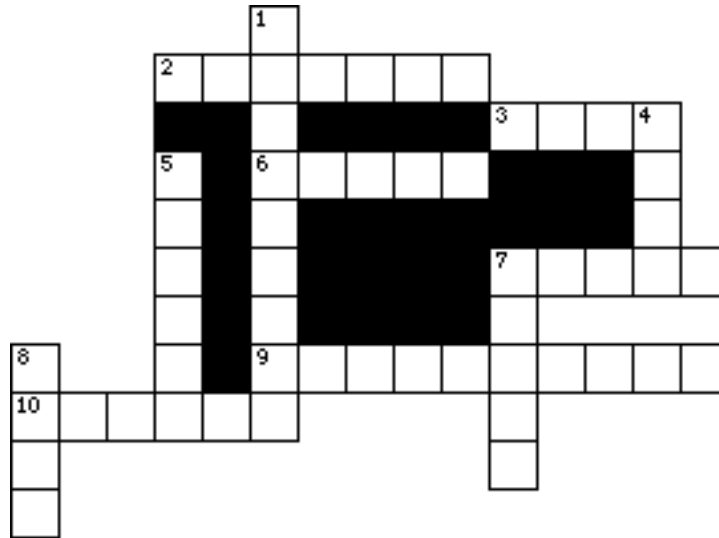

- 2 ACROSS "The Lord knows how to _____ the godly out of temptations and to reserve the unjust under punishment for the day of judgment." **2 PETER 2:9**
- 10 ACROSS "Now the two _____ came to Sodom in the evening, and Lot was sitting in the gate of Sodom. When Lot saw them, he rose to meet them, and he bowed himself with his face toward the ground." **GENESIS 19:1**
- 6 ACROSS "And he said, 'Here now, my lords, please turn in to your servant's house and spend the _____, and was your feet; then you may rise early and go on your way.' And they said, 'No, but we will spend the night in the open square.'" **GENESIS 19:2**
- 7 DOWN "But he insisted strongly; so they turned in to him and entered his _____." **GENESIS 19:3**
- 9 ACROSS "Now before they lay down, the men of the city, the men of Sodom, both old and young, all the people from every quarter, _____ the house." **GENESIS 19:4**
- 4 DOWN "The men reached out their hands and pulled Lot into the house with them, and shut the _____." **GENESIS. 19:10**
- 1 DOWN "And they struck the men who were at the doorway of the house with _____, both small and great, so that they became weary trying to find the door." **GENESIS 19:11**
- 7 ACROSS "When the morning dawned, the angels urged Lot to _____, saying, 'Arise, take your wife and your two daughters who are here, lest you be consumed in the punishment of the city.'" **GENESIS 19:15**
- 5 DOWN "So it came to pass, when they had brought them outside, that he said, '_____ for your life! Do not look behind you nor stay anywhere in the plain. Escape to the mountains, lest you be destroyed.'" **GENESIS 19:17**
- 3 ACROSS "Then the _____ rained brimstone and fire on Sodom and Gomorrah, from the LORD out of the heavens." **GENESIS 19:24**
- 8 DOWN But Lot's wife "looked back behind him, and she became a pillar of _____." **GENESIS 19:26**

Bible Story 19

ISAAC IS BORN

GENESIS 21:1-8

19. ISAAC IS BORN

(GENESIS 21:1-8)



"And Abraham called the name of his son that was born unto him, whom Sarah bare to him, Isaac."

GENESIS 21:3

19. ISAAC IS BORN

(GENESIS 21:1-8)

MEMORY VERSE:

"I will sing of the mercies of the LORD forever; with my mouth will I make known Your faithfulness to all generations." PSALM 89:1

TRUE OR FALSE:

1. "And the LORD visited Sarah as He had said, and the LORD did for Sarah as He had spoken." **GENESIS 21:1**

TRUE OR FALSE

FILL IN THE BLANKS:

2. "For Sarah conceived and bore Abraham a son in his _____ age, at the set time of which God had spoken to him." **GENESIS 21:2**
3. "And Abraham called the name of his son who was born to him - whom Sarah bore to him - _____." **GENESIS 21:3**

CIRCLE THE CORRECT WORDS:

4. "Now Abraham was one (**HUNDRED, THOUSAND**) years old when his son Isaac was born to him." **GENESIS 21:5**
5. "And Sarah said, 'God has made me (**LAUGH, CRY**), so that all who hear will (**LAUGH, CRY**) with me.'" **GENESIS 21:6**

TRUE OR FALSE:

6. "She also said, 'Who would have said to Abraham that Sarah would nurse children? For I have borne him a son in his old age.'" **GENESIS 21:7**

TRUE OR FALSE

FILL IN THE BLANK:

7. "So the child grew and was weaned. And Abraham made a great _____ on the same day that Isaac was weaned." **GENESIS 21:8**

19. ISAAC IS BORN

(GENESIS 21:1-8)

W D L I H C G Q P T M S W E O
 Q S Y F B W X Y G L G G Z F T
 T T H F Y J G E R C A D K J A
 A A U O N N R L E Y A U K T N
 U Z T S A E F N W L F A G E R
 U S Q P N S Q V J I H E S H P
 B D S O M Z I A T O A P Q I I
 O J S E H K P Q B V W Z J J Q
 R N E K O P S H A R A S D Z D
 N Q S O L B H T B Q A L B Z J
 H I I O D Z Z A I Z O H B K Q
 E K L C R F I Q A U D C A C R
 W E A N E D V F M R X C R M I
 R T S F E H V H O A P Q B T L
 J D J K U N B L X N E I K I S

ABRAHAM
 LAUGH
 SPOKEN
 GREW

ISAAC
 SON
 FEAST

SARAH
 CHILD
 OLD

BORN
 LORD
 WEANED

WRITE DOWN THE WORDS OF THE VERSE IN THE CORRECT ORDER ON THE LINES BELOW

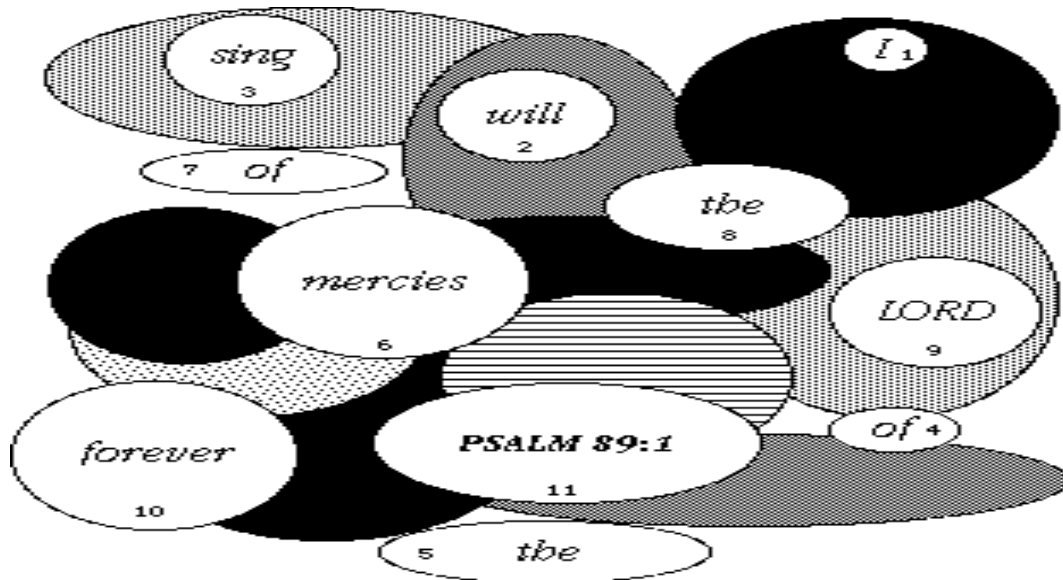

" _____ "

19. ISAAC IS BORN

(GENESIS 21:1-8)

MEMORY VERSE:

"I will sing of the mercies of the LORD forever; with my mouth will I make known Your faithfulness to all generations." PSALM 89:1

FILL IN THE BLANKS:

1. "And the LORD visited Sarah _____, and the LORD did for Sarah _____." **GENESIS 21:1**
2. "For Sarah conceived and bore Abraham a son in his _____ age, at the set time of which God had spoken to him." **GENESIS 21:2**
3. "And Abraham called the name of his son who was born to him - whom Sarah bore to him - _____." **GENESIS 21:3**
4. "Now Abraham was _____ years old when his son Isaac was born to him." **GENESIS 21:5**

CIRCLE THE CORRECT WORDS:

5. "And Sarah said, 'God has made me (**LAUGH, CRY**), so that all who hear will (**LAUGH, CRY**) with me.'" **GENESIS 21:6**

TRUE OR FALSE:

6. "She also said, 'Who would have said to Abraham that Sarah would nurse children? For I have borne him a son in his old age.'" **GENESIS 21:7**
TRUE OR FALSE
7. "So the child grew and was weaned. And Abraham made a great feast on the same day that Isaac was weaned." **GENESIS 21:8**
TRUE OR FALSE

19. ISAAC IS BORN

(GENESIS 21:1-8)

L Y P K D L V I D Z F U Q C P K R K H N
 R R U K P V C C R N F J U D Y G E W X I
 H F Y O K D H T A F E A S T F H N L O S
 I H F J A D A G Z K T K Q W O G C W I V
 D E K Q S B L C U O Q S T K J S V W R U
 Y L T S P Z R J E A H M H I C A A S I U
 E M G P P Z O A M B L J T W W D C R F A
 D G E M R O Z W H H A T T E S D C Z A D
 P M Y B X W M Y W A U A R A S L H O Y H
 U B G B O H F J D E M A R N I I R A X D
 G O M O S Q M T W F R U W E A H E K D W
 I P L H L S Q N Q V U G P D G C M U F T
 C M Q D K I P A X I T E N E W V Q N B L
 E W H S W L S O I O T N N P A B N U E A
 U N V S V H Q S K N D Q R I F G Y D H O
 X G V R J T V L T E D X O Y U C M L T A
 M K G V X N P P A H N N B D T Z A U L P
 K B S N O Y B U L I Q A R B O H S F U A
 U Y N S W O Q T B U C O K B M K V L W D
 Y K B G E A J N Z A L Y B P J K Y Y Q Y

ABRAHAM
BORN
CHILD
FEAST
GREW

ISAAC
LAUGH
LORD
OLD

SARAH
SON
SPOKEN
WEANED

WRITE DOWN THE WORDS OF THE VERSE IN THE CORRECT ORDER ON THE LINES BELOW

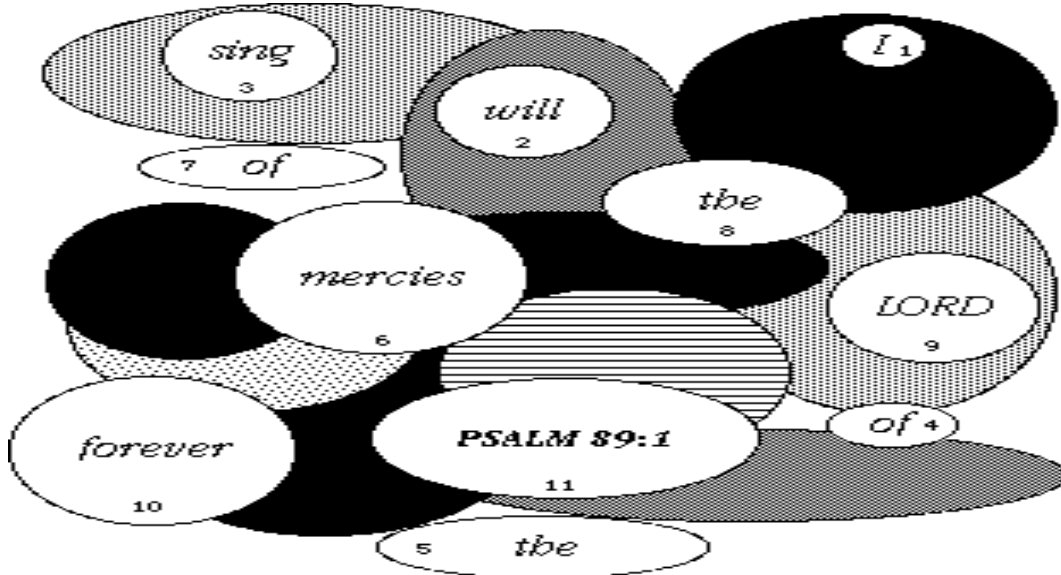

" _____ "

19. ISAAC IS BORN

(GENESIS 21:1-8)

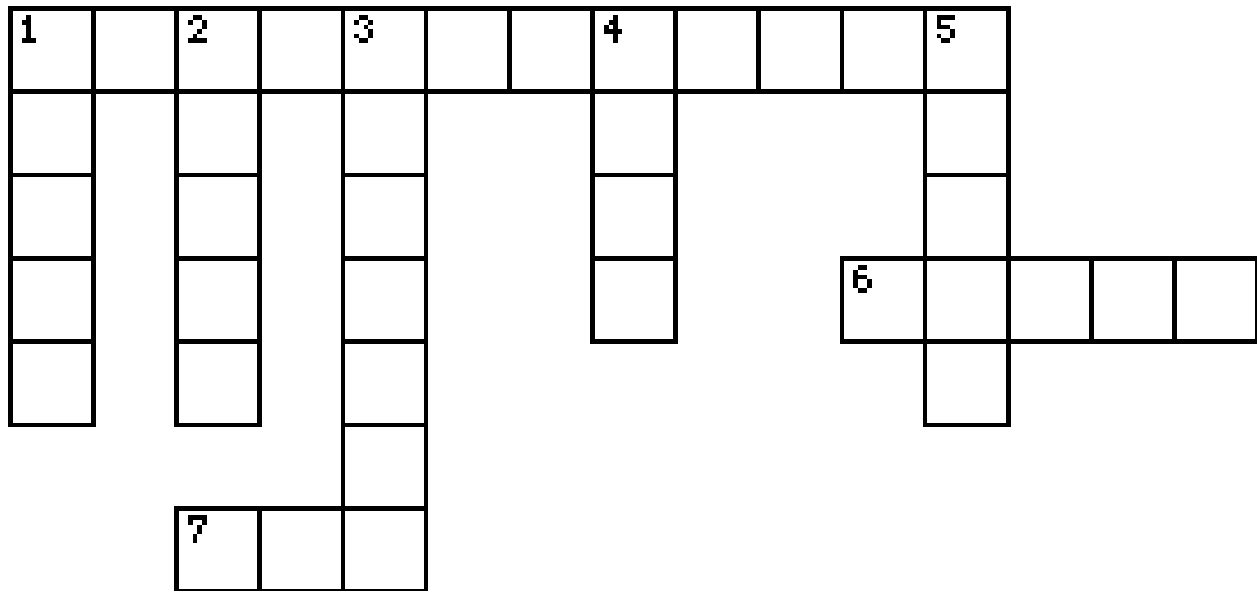

- 1 ACROSS "I will sing of the mercies of the LORD forever; with my mouth will I make known Your _____ to all generations." **PSALM 89:1**
- 4 DOWN "And the _____ visited Sarah as He had said, and the LORD did for Sarah as He had spoken." **GENESIS 21:1**
- 7 ACROSS "For Sarah conceived and bore Abraham a son in his _____ age, at the set time of which God had spoken to him." **GENESIS 21:2**
- 2 DOWN "And Abraham called the name of his son who was born to him - whom Sarah bore to him - _____." **GENESIS 21:3**
- 3 DOWN "Now Abraham was one _____ years old when his son Isaac was born to him." **GENESIS 21:5**
- 6 ACROSS "And Sarah said, 'God has made me _____, so that all who hear will laugh with me.' " **GENESIS 21:6**
- 5 DOWN "She also said, 'Who would have said to Abraham that _____ would nurse children? For I have borne him a son in his old age.' " **GENESIS 21:7**
- 1 DOWN "So the child grew and was weaned. And Abraham made a great _____ on the same day that Isaac was weaned." **GENESIS 21:8**

Bible Story 20

ABRAHAM OFFERS ISAAC

GENESIS 22:1-18

20. ABRAHAM OFFERS ISAAC (GENESIS 22:1-18)



"And Abraham lifted up his eyes, and looked, and behold behind *him* a ram caught in a thicket by his horns: and Abraham went and took the ram, and offered him up for a burnt offering in the stead of his son."

GENESIS 22:13

20. ABRAHAM OFFERS ISAAC (GENESIS 22:1-18)

MEMORY VERSE:

"By faith Abraham, when he was tested, offered up Isaac, and he who had received the promises offered up his only begotten son." HEBREWS 11:17

"Now it came to pass...that God tested Abraham, and said to him, 'Abraham!' And he said, 'Here I am.'" GENESIS 22:1

TRUE OR FALSE:

1. "And He said, 'Take now your son, your only son Isaac, whom you love, and go to the land of Moriah.'" GENESIS 22:2

TRUE OR FALSE

FILL IN THE BLANK:

2. "So Abraham rose early in the morning and saddled his donkey, and took two of his young men with him, and Isaac his son; and he split the wood for the burnt offering, and arose and went to the place of which _____ had told him." GENESIS 22:3

CIRCLE THE CORRECT WORDS:

3. "Then on the (THIRD, FOURTH) day Abraham (OPENED, LIFTED) his eyes and saw the place afar off." GENESIS 22:4
4. "And Abraham said to his young men, 'Stay here with the donkey; the lad and I will go yonder and (WEEP, WORSHIP), and we will come back to you.'" GENESIS 22:5

FILL IN THE BLANKS:

5. "Isaac spoke to Abraham his father and said, 'My father!' And he said, 'Here I am, my son.' And he said, 'Look, the fire and the wood, but where is the _____ for a burnt offering?'" GENESIS 22:7
6. "And Abraham said, 'My son, God will provide _____ a lamb for a burnt offering.' And the two of them went together." GENESIS 22:8

CIRCLE THE CORRECT WORDS:

7. "Then they came to the place of which God had told him. And Abraham built an (HOUSE, ALTAR) there and placed the wood in order; and he bound Isaac his son and laid him on the altar, upon the wood." GENESIS 22:9
8. "But the Angel of the LORD called to him from heaven and said, 'Abraham, Abraham!' And he said, 'Here I am.' And He said, 'Do not lay your hand on the lad, or do anything to him; for now I know that you fear (GOD, MEN), seeing you have not withheld your son, your only son, from Me.'" GENESIS 22:11-12
9. "Then Abraham lifted his eyes and looked, and there behind him was a (DEER, RAM) caught in a thicket by its horns." GENESIS 22:13
10. "And Abraham called the name of the place, The -LORD-Will-Provide, as it is said to this day, 'In the Mount of the LORD it shall be (PROVIDED, HEARD).'" GENESIS 22:14

20. ABRAHAM OFFERS ISAAC

(GENESIS 22:1-18)

A D E R A T L A P D U N C M X
B O W O O D B W A V T G C O D
R K A Y F T B O U N D O O A E
A Q V D E E N O S Y L N O D Y
H M P I H S R O W S M B V T E
A K A J J T K L H A I R O M B
M L D R O E K A X M O U Z M O
E W Q I U D A D E S S E L B P
C D R O L E H T F O L E G N A
N K E P G M A I E R E H K Z C
Q I E D I V O R P C E L F J D
L J N T F D T P V Z E V O L T
O F F E R I N G Q L M P K S M
K S R V K C A A S I X B M A L
D U Y R F L E S M I H M S M X

ABRAHAM
ISAAC
RAM
BOUND
OBEYED

HIMSELF
PROVIDE
BLESSED
MORIAH
WORSHIP

ONLY SON
ANGEL OF THE LORD
LOVE
WOOD
HERE I AM

ALTAR
LAMB
TESTED
GOD
OFFERING



20. ABRAHAM OFFERS ISAAC (GENESIS 22:1-18)

MEMORY VERSE:

"By faith Abraham, when he was tested, offered up Isaac, and he who had received the promises offered up his only begotten son." HEBREWS 11:17

"Now it came to pass...that God tested Abraham, and said to him, 'Abraham!' And he said, 'Here I am.' " GENESIS 22:1

TRUE OR FALSE:

1. "And He said, 'Take now your son, your only son Isaac, whom you love, and go to the land of Moriah.' " GENESIS 22:2

TRUE OR FALSE

FILL IN THE BLANKS:

2. "So Abraham rose early in the morning and saddled his donkey, and took two of his young men with him, and Isaac his son; and he split the wood for the burnt offering, and arose and went to the place of which _____ had told him." GENESIS 22:3
3. "Then on the _____ day Abraham _____ his eyes and saw the place afar off." GENESIS 22:4
4. "And Abraham said to his young men, 'Stay here with the donkey; the lad and I will go yonder and _____, and we will come back to you.' " GENESIS 22:5
5. "Isaac spoke to Abraham his father and said, 'My father!' And he said, 'Here I am, my son.' And he said, 'Look, the fire and the wood, but where is the _____ for a burnt offering?' " GENESIS 22:7
6. "And Abraham said, 'My son, God will provide _____ a lamb for a burnt offering.' And the two of them went together." GENESIS 22:8
7. "Then they came to the place of which God had told him. And Abraham built an _____ there and placed the wood in order; and he bound Isaac his son and laid him on the altar, upon the wood." GENESIS 22:9
8. "But the Angel of the LORD called to him from heaven and said, 'Abraham, Abraham!' And he said, 'Here I am.' And He said, 'Do not lay your hand on the lad, or do anything to him; for now I know that you _____, seeing you have not withheld your son, your only son, from Me.' " GENESIS 22:11-12

TRUE OR FALSE:

9. "Then Abraham lifted his eyes and looked, and there behind him was a ram caught in a thicket by its horns." GENESIS 22:13

TRUE OR FALSE

CIRCLE THE CORRECT WORD:

10. "And Abraham called the name of the place, The -LORD-Will-Provide, as it is said to this day, 'In the Mount of the LORD it shall be (PROVIDED, HEARD).' " GENESIS 22:14

20. ABRAHAM OFFERS ISAAC (GENESIS 22:1-18)

B H T Q E K P X Z I F C O O E C D K Z F C Y N E O
 Y D E Y E B O S X X L M J A V N Q D L K D R I C K
 N N A Z P E I V P G L L F W A P E B U S T G J N C
 M G Q U Z F Q M J Y M B A V T N R K T M X I J A Y
 H X F A C J I A H P S X H M E Q O O M O X K Y I U
 L G G O D T D S G Y Z A A F S L N S V A G U T Z D
 D W H N C E J Z A B F C H S T K R K Y I E A H S Y
 R R O M A H A R B A P W Z W E D Y A O L D V G N G
 E Q P R Q J Q S E D C J Y U D D Y T E H N E F C T
 U I J M S Z R R U R G U N D R O D W M T A O Y Z I
 W P T G I H A H W C K K J S L K F L E S M I H X I
 B H B F W T I M W O B O T J W Q J L X M I X R R P
 O Z I H L Z I P D G O I P H J K I A N Z K O Q O G
 U I A A Z K L X W R U D L Q U L P P O J X U D P M
 N V D R O L E H T F O L E G N A T P B M P V C J C
 D V M A K C S S Y G K T J O O W V A U A P Z M P J
 J B X W K T T V P N C E C E E K R X L I R A P Q N
 N Q T X Q I F O E G U J V W P I F V P E U A O X H
 S Y Y P J O A J Z V M K T E T J E Q M R Z U M Q E
 Z E L E B T Y J W Z O K W B C D E S S E L B E F D
 O F F E R I N G B J D L H K S S J D C H V E A G B
 K L I S B A Y E M P L P P S C U O V C S F F Y A Y
 B N O G R N O A W N S Z J U H E U S V M R P U M K
 Z V B M A L F W U U V Y H H U A G M Z X K T H M K
 F Q V D B R V L F O R Y Q P E V F C K P K O A A J

ABRAHAM
ALTAR
ANGEL OF THE LORD
BLESSED
BOUND

GOD
HERE I AM
HIMSELF
ISAAC
LAMB

LOVE
MORIAH
OBEYED
OFFERING
ONLY SON

PROVIDE
RAM
TESTED
WOOD
WORSHIP



20. ABRAHAM OFFERS ISAAC (GENESIS 22:1-18)

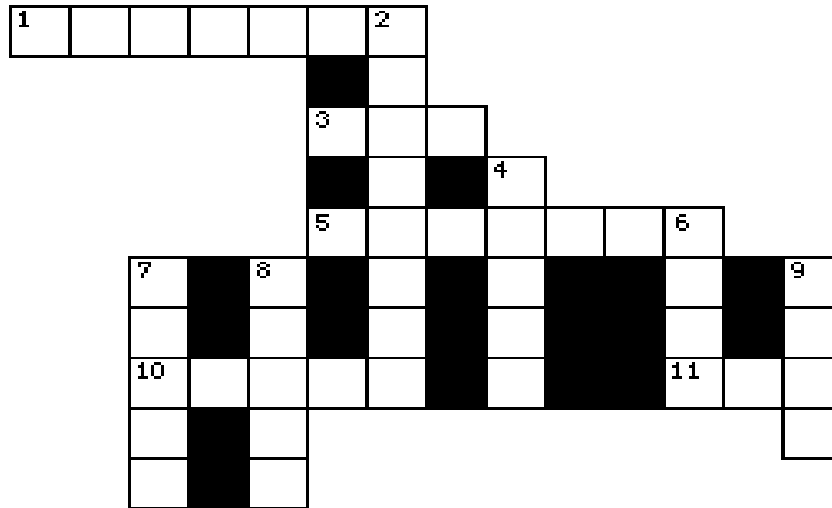

- 8 DOWN "By _____ Abraham, when he was tested, offered up Isaac, and he who had received the promises offered up his only begotten son." **HEBREWS 11:17**
- 4 DOWN "And He said, 'Take now your son, your only son _____ whom you love, and go to the land of Moriah.' " **GENESIS 22:2**
- 3 ACROSS "So Abraham rose early in the morning and saddled his donkey, and took two of his young men with him, and Isaac his son; and he split the wood for the burnt offering, and arose and went to the place of which _____ had told him." **GENESIS 22:3**
- 10 ACROSS "Then on the _____ day Abraham lifted his eyes and saw the place afar off." **GENESIS 22:4**
- 1 ACROSS "And Abraham said to his young men, 'Stay here with the donkey; the lad and I will go yonder and _____, and we will come back to you.' " **GENESIS 22:5**
- 9 DOWN "Isaac spoke to Abraham his father and said, 'My father!' And he said, 'Here I am, my son.' And he said, 'Look, the fire and the wood, but where is the _____ for a burnt offering?' " **GENESIS 22:7**
- 5 ACROSS "And Abraham said, 'My son, God will provide _____ a lamb for a burnt offering.' And the two of them went together." **GENESIS 22:8**
- 7 DOWN "Then they came to the place of which God had told him. And Abraham built an _____ there and placed the wood in order; and he bound Isaac his son and laid him on the altar, upon the wood." **GENESIS 22:9**
- 6 DOWN "But the Angel of the LORD called to him from heaven and said, 'Abraham, Abraham!' And he said, 'Here I am.' And He said, 'Do not lay your hand on the lad, or do anything to him; for now I know that you _____ God, seeing you have not withheld your son, your only son, from Me.' " **GENESIS 22:11-12**
- 11 ACROSS "Then Abraham lifted his eyes and looked, and there behind him was a _____ caught in a thicket by its horns." **GENESIS 22:13**
- 2 DOWN "And Abraham called the name of the place, The -LORD-Will-Provide, as it is said to this day, 'In the Mount of the LORD it shall be _____.' " **GENESIS 22:14**

Bible Story 21

A BRIDE FOR ISAAC

GENESIS 24:1-67

21. A BRIDE FOR ISAAC

(GENESIS 24:1-67)



"And let it come to pass, that the damsel to whom I shall say, Let down thy pitcher, I pray thee, that I may drink; and she shall say, Drink, and I will give thy camels drink also: *let the same be she that thou hast appointed for thy servant Isaac*; and thereby shall I know that thou hast shewed kindness unto my master."

GENESIS. 24:14

21. A BRIDE FOR ISAAC

(GENESIS 24:1-67)

MEMORY VERSE:

"And as the bridegroom rejoices over the bride, so shall your God rejoice over you."
ISAIAH 62:5

CIRCLE THE CORRECT WORDS:

1. "Abraham said to the oldest servant of his house, who ruled over all that he had, 'Please put you hand under my thigh, and I will make you swear by the LORD, the God of heaven and the God of the earth, that you will not take a wife for my son from the daughters of the Canaanites, among whom I dwell; but you shall go to my (COUNTRY, STORE) and to my (KINGDOM, KINDRED) and take a wife for my son Isaac.'" **GENESIS 24:2-4**
2. Abraham said, "The LORD God of heaven, who took me from my father's house and from the land of my kindred, and who spoke to me and swore to me, saying, 'To your descendants I give this land,' He will send His angel before you, and you shall take a (CHARIOT, WIFE) for my son from there." **GENESIS. 24:7**
3. "The servant took ten of his master's camels and departed, for all his master's goods were in his hand. And he arose and went to (EGYPT, MESOPOTAMIA), to the city of Nahor." **GENESIS 24:10**
4. "And he made his camels kneel down outside the city by a (LAKE, WELL) of water at evening time, the time when women go out to draw water. Then he said, 'O LORD God of my master Abraham, please give me success this day, and show kindness to my master Abraham.'" **GENESIS 24:11-12**

FILL IN THE BLANKS:

5. He also said, "Now let it be that the young woman to whom I say, 'Please let down your pitcher that I may _____,' and she says, '_____', and I will also give your camels a _____' - let her be the one whom You have appointed for Your servant Isaac." **GENESIS. 24:14**

CIRCLE THE CORRECT WORDS:

6. "And it happened, (BEFORE, AFTER) he had finished speaking, that behold, Rebekah, who was born to Bethuel, son of Milcah, the wife of Nahor, Abraham's brother, came out with her pitcher on her shoulder...And when she had finished giving him a drink, she said, 'I (WILL, WILL NOT) draw water for your camels also, until they have finished drinking.'" **GENESIS 24:15, 19**
7. "Then the man bowed down his head and (WORSHIPED, CRIED TO) the LORD." **GENESIS 24:26**
8. "So the young woman (WALKED, RAN) and told those of her mother's house these things." **GENESIS. 24:28**
9. "Then they called Rebekah and said to her, 'Will you go with this man?' And she said, 'I (WILL, WILL NOT) go.'" **GENESIS 24:58**
10. "Now Isaac went out to meditate in the field in the evening; and he (LIFTED, RUBBED) his eyes and looked, and there, the camels were coming. Then Rebekah (LIFTED, RUBBED) her eyes, and when she saw Isaac she dismounted from her camel." **GENESIS 24:63-64**

THEN ISAAC "TOOK REBEKAH AND SHE BECAME HIS WIFE, AND HE LOVED HER." GENESIS 24:67

21. A BRIDE FOR ISAAC

(GENESIS 24:1-67)

MEMORY VERSE:

"And as the bridegroom rejoices over the bride, so shall your God rejoice over you."
ISAIAH 62:5

FILL IN THE BLANKS:

1. "Abraham said to the oldest servant of his house, who ruled over all that he had, 'Please put your hand under my thigh, and I will make you swear by the LORD, the God of heaven and the God of the earth, that you will not take a wife for my son from the daughters of the Canaanites, among whom I dwell; but you shall go to my _____ and to my _____ and take a wife for my son Isaac.'" **GENESIS 24:2-4**
2. Abraham said, "The LORD God of heaven, who took me from my father's house and from the land of my kindred, and who spoke to me and swore to me, saying, 'To your descendants I give this land,' He will send His angel before you, and you shall take a _____ for my son from there." **GENESIS. 24:7**
3. "The servant took ten of his master's camels and departed, for all his master's goods were in his hand. And he arose and went to _____, to the city of Nahor." **GENESIS 24:10**
4. "And he made his camels kneel down outside the city by a _____ of water at evening time, the time when women go out to draw water. Then he said, 'O LORD God of my master Abraham, please give me success this day, and show kindness to my master Abraham.'" **GENESIS 24:11-12**
5. He also said, "Now let it be that the young woman to whom I say, 'Please let down your pitcher that I may _____,' and she says, '_____', and I will also give your camels a _____' - let her be the one whom You have appointed for Your servant Isaac." **GENESIS. 24:14**

CIRCLE THE CORRECT WORDS:

6. "And it happened, (**BEFORE, AFTER**) he had finished speaking, that behold, Rebekah, who was born to Bethuel, son of Milcah, the wife of Nahor, Abraham's brother, came out with her pitcher on her shoulder...And when she had finished giving him a drink, she said, 'I (**WILL, WILL NOT**) draw water for your camels also, until they have finished drinking.'" **GENESIS 24:15, 19**
7. "Then the man bowed down his head and (**WORSHIPED, CRIED TO**) the LORD." **GENESIS 24:26**
8. "So the young woman (**WALKED, RAN**) and told those of her mother's house these things." **GENESIS. 24:28**

FILL IN THE BLANKS:

9. "Then they called Rebekah and said to her, 'Will you go with this man?' And she said, 'I _____go.'" **GENESIS 24:58**
10. "Now Isaac went out to meditate in the field in the evening; and he _____ his eyes and looked, and there, the camels were coming. Then Rebekah _____ her eyes, and when she saw Isaac she dismounted from her camel." **GENESIS 24:63-64**

THEN ISAAC "TOOK REBEKAH AND SHE BECAME HIS WIFE, AND HE LOVED HER." GENESIS 24:67

21. A BRIDE FOR ISAAC (GENESIS 24:1-67)

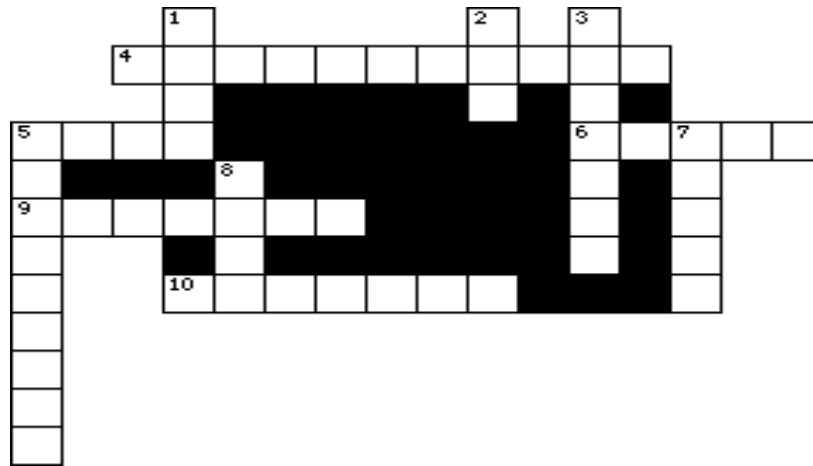

- 9 ACROSS "And as the bridegroom rejoices over the bride, so shall your God _____ over you." **ISAIAH 62:5**
- 3 DOWN "Abraham said to the oldest servant of his house, who ruled over all that he had, 'Please put your hand you will not take a wife for my son from the daughters of the Canaanites, among whom I dwell; but you shall go to my country and to my _____ and take a wife for my son Isaac.'" **GENESIS 24:2-4**
- 8 DOWN Abraham said, "The LORD God of heaven, who took me from my father's house and from the land of my kindred, and who spoke to me and swore to me, saying, 'To your descendants I give this land,' He will send His angel before you, and you shall take a _____ for my son from there." **GENESIS 24:7**
- 4 ACROSS "The servant took ten of his master's camels and departed, for all his master's goods were in his hand. And he arose and went to _____, to the city of Nahor." **GENESIS 24:10**
- 1 DOWN "And he made his camels kneel down outside the city by a _____ of water at evening time, the time when women go out to draw water. Then he said, 'O LORD God of my master Abraham, please give me success this day, and show kindness to my master Abraham.'" **GENESIS 24:11-12**
- 6 ACROSS He also said, "Now let it be that the young woman to whom I say, 'Please let down your pitcher that I may _____,' and she says, 'Drink, and I will also give your camels a drink' - let her be the one whom You have appointed for Your servant Isaac." **GENESIS 24:14**
- 5 ACROSS "And it happened, after he had finished speaking, that behold, Rebekah, who was born to Bethuel, son of Milcah, the wife of Nahor, Abraham's brother, came out with her pitcher on her shoulder...And when she had finished giving him a drink, she said, 'I _____ draw water for your camels also, until they have finished drinking.'" **GENESIS 24:15, 19**
- 5 DOWN "Then the man bowed down his head and _____ the LORD." **GENESIS 24:26**
- 2 DOWN "So the young woman _____ and told those of her mother's house these things." **GENESIS 24:28**
- 10 ACROSS "Then they called _____ and said to her, 'Will you go with this man?' And she said, 'I will go.'" **GENESIS 24:58**
- 7 DOWN "Now _____ went out to meditate in the field in the evening; and he lifted his eyes and looked, and there, the camels were coming. Then Rebekah lifted her eyes, and when she saw Isaac she dismounted from her camel." **GENESIS 24:63-64**

Bible Story 22

JACOB & ESAU

GENESIS 25:19-34; 27:1-46; 33

22. JACOB & ESAU

(GENESIS 25:19-34; 27:1-46; 33)



"And Esau ran to meet him, and embraced him, and fell on his neck, and kissed him: and they wept."

GENESIS 33:4

22. JACOB & ESAU

(GENESIS 25:19-34; 27:1-46; 33)

MEMORY VERSE:

Pursue peace with all men, and holiness, without which no one will see the Lord."

HEBREWS 12:14

CIRCLE THE CORRECT WORDS:

1. When the first child was born, "he was like a (**HAIRY**, **SMOOTH**) garment all over; so they called his name Esau." **GENESIS 25:25**
2. When his brother was born, "his hand took hold of Esau's (**EAR**, **HEEL**); so his name was called Jacob." **GENESIS 25:26**

FILL IN THE BLANKS:

3. "So the boys grew. And _____ was a skillful hunter, a man of the field; but _____ was a mild man, dwelling in tents." **GENESIS 25:27**

CIRCLE THE CORRECT WORDS:

4. "Now Jacob cooked a (**BURGER**, **STEW**); and Esau came in from the field, and he was weary. And Esau said to Jacob, 'Please feed me with that same red (**BURGER**, **STEW**), for I am weary.' Therefore his name was (**EDOM**, **STEW**)." **GENESIS 25:29-30**
5. "But Jacob said, 'Sell me your (**BIRTHRIGHT**, **SHOES**) as of this day.' And Esau said, 'Look, I am about to die; so what profit shall this (**BIRTHRIGHT**, **SHOE**) be to me?' Then Jacob said, 'Swear to me as of this day.' So he swore to him, and sold his (**BIRTHRIGHT**, **SHOES**) to Jacob." **GENESIS 25:31-33**

ISAAC SOUGHT TO BLESS ESAU, BUT REBEKAH SENT IN JACOB TO GET THE BLESSING FROM HIS FATHER...

6. "So he went to his father and said, 'My father'; and he said, 'Here I am. Who are you, my son?' And Jacob said to his father, 'I am Esau your firstborn; I have done just as you told me; please arise, sit and eat of my game, that your soul may (**BLESS**, **CURSE**) me.'" **GENESIS 27:18-19**
7. "Esau said, 'Is he not rightly named Jacob? For he has (**SUPPLANTED**, **PLANTED**) me these two times. He took away my birthright, and now look, he has taken away my blessing!' " **GENESIS 27:36**
8. "So Esau (**LOVED**, **HATED**) Jacob because of the blessing with which his father blessed him, and Esau said in his heart, 'The days of mourning for my father are at hand; then I will kill my brother Jacob.'" **GENESIS 27:41**
9. After Isaac blessed Jacob, he "sent Jacob away, and he went to Padan Aram, to (**LABAN**, **ABRAM**) the son of Bethuel the Syrian, the brother of Rebekah, the mother of Jacob and Esau." **GENESIS 28:5**
10. Jacob feared his brother, but when he returned to the land of Canaan, "Esau (**WALKED**, **RAN**) to meet him, and embraced him, and fell on his neck and kissed him, and they wept." **GENESIS 33:4**
11. Jacob said to Esau, 'Please, take my blessing that is brought to you, because (**GOD**, **LABAN**) has dealt graciously with me, and because I have enough.' And he urged him, and he took it." **GENESIS. 33:11**

22. JACOB & ESAU

(GENESIS 25:19-34; 27:1-46; 33)

B	R	K	E	H	J	E	F	I	S	A	A	C	I	X
A	G	C	E	A	D	H	U	N	T	E	R	B	T	K
R	W	E	C	O	S	T	N	E	T	T	W	I	N	S
R	L	O	M	E	S	N	O	I	T	A	N	O	W	T
E	B	U	T	N	S	T	R	O	N	G	E	R	N	L
N	K	S	N	B	A	Y	R	I	A	H	E	G	B	S
E	G	E	R	W	I	A	Z	B	B	A	P	O	P	A
V	Q	L	S	E	Q	R	N	R	A	L	C	A	Y	V
R	N	P	G	A	E	M	T	A	B	O	E	T	P	O
E	G	O	Q	R	U	L	A	H	C	W	V	S	Z	R
S	H	E	A	Y	A	M	F	Z	R	R	T	Q	S	Y
N	W	P	L	O	R	D	D	F	N	I	A	X	I	W
R	Z	O	R	E	B	E	K	A	H	E	G	T	C	F
S	G	W	F	J	R	J	P	I	V	T	S	H	L	I
C	V	T	W	N	B	L	M	S	T	E	W	M	T	A

ALTAR
BARREN
BIRTHRIGHT
BLESS
EDOM
ESAU
FLEE

GOATS
HAIRY
HEEL
HUNTER
ISAAC
JACOB
CANAAN

LORD
REBEKAH
RED
SAVORY
SERVE
STEW

STRONGER
TENTS
TWINS
TWO NATIONS
TWO PEOPLES
WEARY

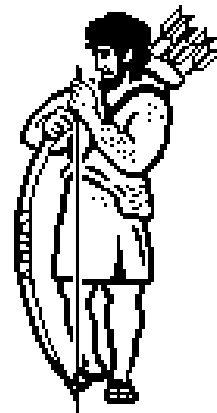

22. JACOB & ESAU

(GENESIS 25:19-34; 27:1-46; 33)

MEMORY VERSE:

"Pursue peace with all men, and holiness, without which no one will see the Lord."

HEBREWS 12:14

FILL IN THE BLANKS:

1. When the first child was born, "he was like a _____ garment all over; so they called his name Esau."
GENESIS 25:25
2. When his brother was born, "his hand took hold of Esau's _____; so his name was called Jacob."
GENESIS 25:26
3. "So the boys grew. And _____ was a skillful hunter, a man of the field; but _____ was a mild man, dwelling in tents." **GENESIS 25:27**

CIRCLE THE CORRECT WORDS:

4. "Now Jacob cooked a (**BURGER, STEW**); and Esau came in from the field, and he was weary. And Esau said to Jacob, 'Please feed me with that same red (**BURGER, STEW**), for I am weary.' Therefore his name was (**EDOM, STEW**)." **GENESIS 25:29-30**
5. "But Jacob said, 'Sell me your (**BIRTHRIGHT, SHOES**) as of this day.' And Esau said, 'Look, I am about to die; so what profit shall this (**BIRTHRIGHT, SHOE**) be to me?' Then Jacob said, 'Swear to me as of this day.' So he swore to him, and sold his (**BIRTHRIGHT, SHOES**) to Jacob." **GENESIS 25:31-33**

ISAAC SOUGHT TO BLESS ESAU, BUT REBEKAH SENT IN JACOB TO GET THE BLESSING FROM HIS FATHER...

FILL IN THE BLANKS:

6. "So he went to his father and said, 'My father'; and he said, 'Here I am. Who are you, my son?' And Jacob said to his father, 'I am Esau your firstborn; I have done just as you told me; please arise, sit and eat of my game, that your soul may _____ me.'" **GENESIS 27:18-19**
7. "Esau said, 'Is he not rightly named Jacob? For he has _____ me these two times. He took away my birthright, and now look, he has taken away my blessing!' " **GENESIS 27:36**
8. "So Esau _____ Jacob because of the blessing with which his father blessed him, and Esau said in his heart, 'The days of mourning for my father are at hand; then I will kill my brother Jacob.'" **GENESIS 27:41**
9. After Isaac blessed Jacob, he "sent Jacob away, and he went to Padan Aram, to _____ the son of Bethuel the Syrian, the brother of Rebekah, the mother of Jacob and Esau." **GENESIS 28:5**

CIRCLE THE CORRECT WORDS:

10. Jacob feared his brother, but when he returned to the land of Canaan, "Esau (**WALKED, RAN**) to meet him, and embraced him, and fell on his neck and kissed him, and they wept." **GENESIS 33:4**
11. Jacob said to Esau, 'Please, take my blessing that is brought to you, because (**GOD, LABAN**) has dealt graciously with me, and because I have enough.' And he urged him, and he took it." **GENESIS. 33:11**

22. JACOB & ESAU

(GENESIS 25:19-34; 27:1-46; 33)

L V B E W M G F I B L A B Y U R N V V Z E V Z Z H H R N S Q
 B O L B C H Y L P V O S V Y V M R K B S S U Y P G J G A K X
 M S O D A Y Q K Q B P P H E C I G B L B G A O A Q M V V L A
 I K U V Z Y D I F W D W E H G F I M O E Y G R K J O Q A W F
 O L P N S M O Q R Y Q J E L O J K S R W M O C W R U A O F S
 X D W P D B O S C U J H L B Q Q F H D G X J C Y W N F W I Z
 K F C Y G P E S G K R E T N U H T Y R A E W U O C N W E W I
 E A P G P R K S O Y J N Q R A E S J K T O D B Y A R E T K L
 Y B R N V R P O W H C T W I N S T L W B L E R K N S J E O Y
 T R F E C Y Z E S F X F O O E P O O G T F Q X Z A C N P W R
 E X M W V N S Z J N V G V W G G P X E T W W P U A R Q C F L
 Z E E F L E E P V Q O I Y H A E Y N P D U D I M N G A V U P
 Q W T Y U R T E H X D I S J O G T B E P U U Y P R W B T A F
 V G L Z I R V U Y H I T T P T S T K I T Y A V E L K M S H S
 L F M U P A G V G M A E L A N L T N N C O B B G Q G M B O T
 S Z E G N B W F M O M E X S N Y G P A P L E N K P Q J Q D X
 R A Z F S R D I G G S G C R B O F F V N K C W L W N L X X C
 S N I Y C J A C O B O W J V K T W H I A P Q E W E G F M K F
 B S I I N E K U X Q O K N T L P I T H B Z K H X T H Z I S T
 B H D F P X A Y U W K O B H D V Y J W I P S T R O N G E R I
 B L E S S V R H V G U I L G O E M K A V Z H Z K F W A T L N
 Z U Z B C I G I E C A A S I H N R Z M G X C J N O Z P N Z W
 F R P L A T S P Z X D L L R Y J A W H U P H Q I R G M B I D
 W S A H X O A K U W I D D H Q A U W L K P L B I U V B P C E
 X Y Z T C J E D O M S S N T K R V V A J T U M C A K R Y D S
 Y J V A L Q U R U T V U K R G H E H Z W S A G J M C Z P C A
 L N U E X A K E E D E J A I O N W D Y S A B B H Q U F Z Q U
 N D D Z P L S W I I M L U B J Y A W E F W G H M P E I I U T
 D Y W C R P Y N X C N J W J M W T S K Z I D P U B T A C W I
 C I E L E V X A Q P B T K D N C Z R G Z L V N J T N B X X Z

ALTAR
 REBEKAH
 BLESS
 SERVE
 ESAU

FLEE
 TENTS
 HEEL
 TWO PEOPLES
 JACOB

LORD
 BIRTHRIGHT
 SAVORY
 EDM

STRONGER
 HAIRY
 TWO NATIONS
 ISAAC

BARREN
 RED
 CANAAN
 STEW

GOATS
 TWINS
 HUNTER
 WEARY



22. JACOB & ESAU

(GENESIS 25:19-34; 27:1-46; 33)

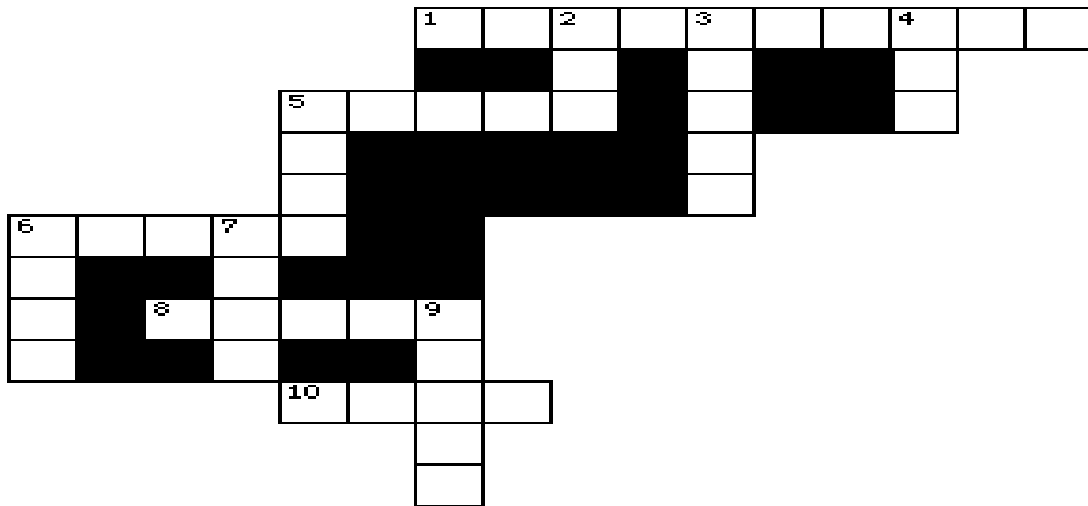

- 5 DOWN "Pursue peace with all men, and holiness, without which no one will see the _____"
HEBREWS 12:14
- 3 DOWN When the first child was born, "he was like a _____ garment all over; so they called his name Esau." **GENESIS. 25:25**
- 6 DOWN When his brother was born, "his hand took hold of Esau's _____ ; so his name was called Jacob." **GENESIS. 25:26**
- 7 DOWN "So the boys grew. And _____ was a skillful hunter, a man of the field; but Jacob was a mild man, dwelling in tents." **GENESIS 25:27**
- 10 ACROSS "Now Jacob cooked a _____; and Esau came in from the field, and he was weary. And Esau said to Jacob, 'Please feed me with that same red stew, for I am weary.' Therefore his name was Edom."
GENESIS 25:29-30
- 1 ACROSS "But Jacob said, 'Sell me your _____ as of this day.' And Esau said, 'Look, I am about to die; so what profit shall this birthright be to me?' Then Jacob said, 'Swear to me as of this day.' So he swore to him, and sold his birthright to Jacob." **GENESIS 25:31-33**
- 9 DOWN "So he went to his father and said, 'My father'; and he said, 'Here I am. Who are you, my son?' And Jacob said to his father, 'I am Esau your firstborn; I have done just as you told me; please arise, sit and eat of my game, that your soul may _____ me.'" **GENESIS 27:18-19**
- 8 ACROSS "Esau said, 'Is he not rightly named _____? For he has supplanted me these two times. He took away my birthright, and now look, he has taken away my blessing!'" **GENESIS 27:36**
- 6 ACROSS "So Esau _____ Jacob because of the blessing with which his father blessed him, and Esau said in his heart, 'The days of mourning for my father are at hand; then I will kill my brother Jacob.'"
GENESIS 27:41
- 5 ACROSS After Isaac blessed Jacob, he "sent Jacob away, and he went to Padan Aram, to _____ the son of Bethuel the Syrian, the brother of Rebekah, the mother of Jacob and Esau." **GENESIS 28:5**
- 2 DOWN Jacob feared his brother, but when he returned to the land of Canaan, "Esau _____ to meet him, and embraced him, and fell on his neck and kissed him, and they wept." **GENESIS 33:4**
- 4 DOWN Jacob said to Esau, 'Please, take my blessing that is brought to you, because _____ has dealt graciously with me, and because I have enough.' And he urged him, and he took it." **GENESIS 33:11**

Bible Story 23

**ISAAC
BLESSES JACOB**

GENESIS 27:1-46

23. ISAAC BLESSES JACOB

(GENESIS 27:1-46)



“And when Esau heard the words of his father, he cried with a great and exceeding bitter cry, and said unto his father, Bless me, *even* me also, O my father. And he said, Thy brother came with subtilty, and hath taken away thy blessing.”

GENESIS 27:34-35

23. ISAAC BLESSES JACOB

(GENESIS 27:1-46)

MEMORY VERSE:

"By faith Isaac blessed Jacob and Esau concerning things to come." HEBREWS 11:20

TRUE OR FALSE:

1. "Now it came to pass, when Isaac was old and his eyes were so dim that he could not see, that he called Esau his older son and said to him, 'My son.' And he answered him, 'Here I am.'" **GENESIS 27 :1**

TRUE OR FALSE

2. Isaac said to Esau, "Make me savory food, such as I love, and bring it to me that I may eat, that my soul may bless you before I die." **GENESIS 27:4**

TRUE OR FALSE

CIRCLE THE CORRECT WORD:

3. "Now Rebekah was (**LISTENING, LAUGHING**) when Isaac spoke to Esau his son. And Esau went to the field to hunt game and to bring it." **GENESIS 27:5**

TRUE OR FALSE:

4. Rebekah said, "I guess your brother Esau shall be blessed by your father Isaac instead of you." **GENESIS 27:9-10**

TRUE OR FALSE

5. "Then Rebekah took the choice clothes of her elder son Esau, which were with her in the house, and put them on Jacob her younger son." **GENESIS 27:15**

TRUE OR FALSE

FILL IN THE BLANKS:

6. Rebekah "put the skins of the kids of the goats on his _____ and on the smooth part of his _____." **GENESIS 27:16**

CIRCLE THE CORRECT WORDS:

7. Isaac "did not recognize him, because his hands were (**SMOOTH, HAIRY**) like his brother Esau's hands; so he blessed him." **GENESIS 27:23**
8. "Then it happened, as soon as Isaac had finished blessing Jacob, and Jacob had scarcely gone out from the presence of Isaac his father, that Esau his brother came in from his (**HUNTING, FISHING**)." **GENESIS 27:30**
9. Isaac said to Esau, "Your brother came with (**HONESTY, DECEIT**) and has taken away your blessing." **GENESIS 27:35**
10. "So Esau hated Jacob because of the blessing with which his father blessed him, and Esau said in his (**HEART, HEAD**), 'The days of mourning for my father are at hand; then I will kill my brother Jacob.'" **GENESIS 27:41**

23. ISAAC BLESSES JACOB

(GENESIS 27:1-46)

N A F F T U A N T C I Y I O Z
 D L V F D I F I R S T B O R N
 R E I S S E A A T D Y F A M H
 A B C A A J L Y R W S D N A H
 Z Z A I T V U B R K B O G J K
 E C O T O K O Q M E E L F K K
 M Z N B D V H R W E B J W G R
 D N N A L S E A Y S R W A H E
 W H H Q B E N U K F T T F G Y
 Q K U H D A S Q P E O A U D R
 O L D N A M L S N E B O O V I
 X O I A T N Q T D I S E D G A
 I B U U Q I G H K I P A R B H
 J A C O B J N E B E M S U G N
 T H A U C T X G R P P S T C C

ANGER
 DIM
 ISAAC

GOATS
 HANDS
 TREMBLED

LABAN
 REBEKAH
 FLEE

BLESS
 ESAU
 JACOB

HAIRY
 HUNTING
 VOICE

OLD
 FIRSTBORN
 SAVORY FOOD

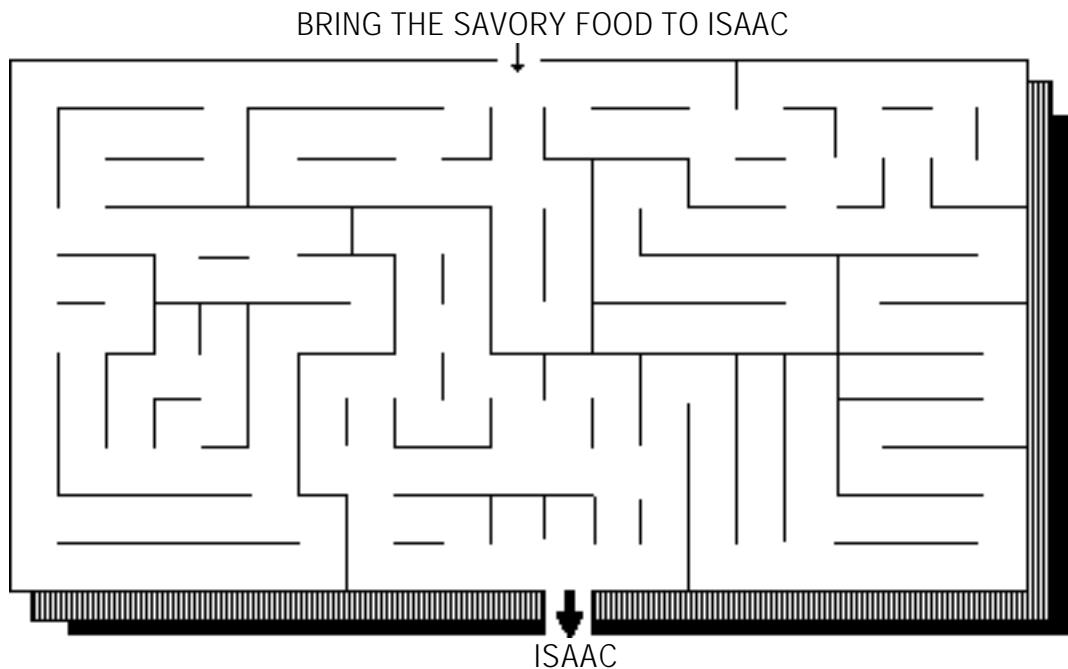

23. ISAAC BLESSES JACOB

(GENESIS 27:1-46)

MEMORY VERSE:

"By faith Isaac blessed Jacob and Esau concerning things to come." HEBREWS 11:20

TRUE OR FALSE:

1. "Now it came to pass, when Isaac was old and his eyes were so dim that he could not see, that he called Esau his older son and said to him, 'My son.' And he answered him, 'Here I am.' "
GENESIS 27 :1

TRUE OR FALSE

2. Isaac said to Esau, "Make me savory food, such as I love, and bring it to me that I may eat, that my soul may bless you before I die." **GENESIS 27:4**

TRUE OR FALSE

FILL IN THE BLANKS:

3. "Now _____ was _____ when Isaac spoke to Esau his son. And Esau went to the field to hunt game and to bring it." **GENESIS 27:5**

TRUE OR FALSE:

4. Rebekah said, "I guess your brother Esau shall be blessed by your father Isaac instead of you."
GENESIS 27:9-10

TRUE OR FALSE

FILL IN THE BLANKS:

5. "Then Rebekah took the choice _____ of her elder son Esau, which were with her in the house, and put them on Jacob her younger son." **GENESIS 27:15**
6. Rebekah "put the skins of the kids of the goats on his _____ and on the smooth part of his _____." **GENESIS 27:16**

CIRCLE THE CORRECT WORDS:

7. Isaac "did not recognize him, because his hands were (**SMOOTH, HAIRY**) like his brother Esau's hands; so he blessed him." **GENESIS 27:23**
8. "Then it happened, as soon as Isaac had finished blessing Jacob, and Jacob had scarcely gone out from the presence of Isaac his father, that Esau his brother came in from his (**HUNTING, FISHING**)." **GENESIS 27:30**

FILL IN THE BLANKS:

9. Isaac said to Esau, "Your brother came with _____ and has taken away your blessing."
GENESIS 27:35
10. "So Esau hated Jacob because of the blessing with which his father blessed him, and Esau said in his _____, 'The days of mourning for my father are at hand; then I will _____ my brother Jacob.' " **GENESIS 27:41**

23. ISAAC BLESSES JACOB

(GENESIS 27:1-46)

C D L W F L V B N R P Q U G Q C S T E A E N A V H
 J C B X Z O U L P E Z S H M X X P B H T P R T A Y
 K Z M Y A U D A C M S S I X H O W V L N G G N H E
 V R I L N P W E X V T O P U M L J Q B B G D Z W K
 O D O N S I E Z C T V E K V G D H O R K S I V S G
 B Y X D S W E C G N I T N U H V T V O L J K K R Z
 Y Q K A H C B L X E G Z R E Q R N Y W D A F B V S
 D Q A C U P D N P C W P E Z E D D X H O C T M B B
 G C E V S R V W R I D E N M W I F C J H O S S K E
 C H Y O S F N C U O K U B U M I G J S Y B T H G W
 X F T S E M P A A V B L A U G L A B A N L O J P G
 E O E K L E Y Z S O E T I I X M I N R Q Y Y L E B
 K I Z L B T G S E D A V S X W O E B V K T T X I T
 Y H Q D S L N D R J G F P R D O G L J G P T B N D
 B H V F G O A T S Q S I Q Q I F W L D O V G K A P
 Z Q L A Y M W G E L A D F B I F K D U J E F N V T
 H A I R Y E E P M P U O R V C U O R E B E K A H C
 U U S B J E Y C H V K O C B P D I N V M N I P I P
 F F R R L Z Z V Y G S F G W L I L K C N J Y F W N
 R U S F N I U U Y Y Y O Y O V D A G R A M H A B
 J E B X D I G I M Q X R W U P E S U O M H R J M I
 U M G E Y D F P B D F O J K D M U W Q I N A K H V
 X N B N I Z Y N P O L V V Y Q N J K A F Y U Z L G
 K V Z W A P I S R O K A H H J B L Y E J W V W A U
 B S F G B Z F C Y K I S Y F J A J Y G Q C W W Z K

ANGER	GOATS	LABAN	BLESS	HAIRY
OLD	DIM	HANDS	REBEKAH	ESAU
HUNTING	FIRSTBORN	ISAAC	TREMLED	FLEE
JACOB	VOICE	SAVORY FOOD		



23. ISAAC BLESSES JACOB (GENESIS 27:1-46)

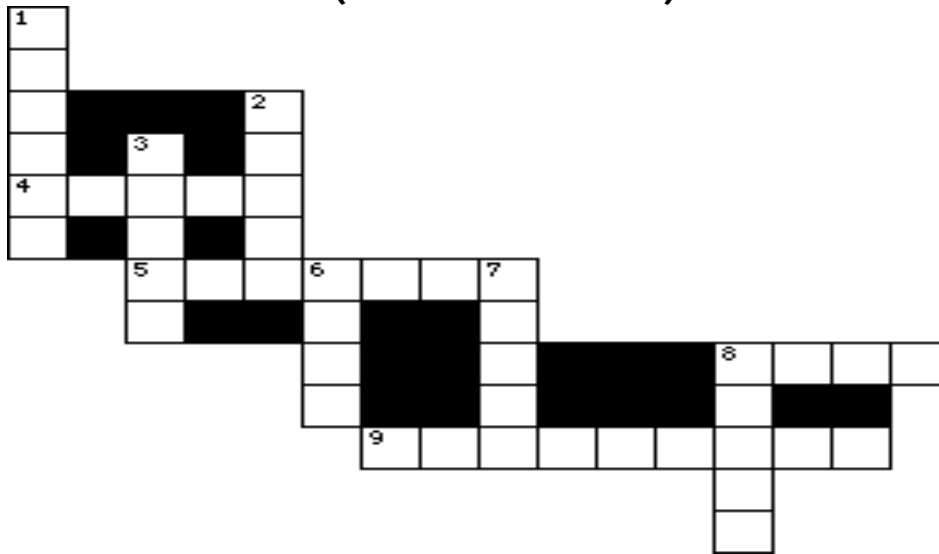

- 8 DOWN "By _____ Isaac blessed Jacob and Esau concerning things to come." **HEBREWS 11:20**
- 4 ACROSS "Now it came to pass, when _____ was old and his eyes were so dim that he could not see, that he called Esau his older son and said to him, 'My son.' And he answered him, 'Here I am.' "**GENESIS 27 :1**
- 8 ACROSS Isaac said to Esau, "Make me savory _____ such as I love, and bring it to me that I may eat, that my soul may bless you before I die." **GENESIS 27:4**
- 9 ACROSS "Now Rebekah was _____ when Isaac spoke to Esau his son. And Esau went to the field to hunt game and to bring it." **GENESIS 27:5**
- 5 ACROSS "Then _____ took the choice clothes of her elder son Esau, which were with her in the house, and put them on Jacob her younger son." **GENESIS 27:15**
- 7 DOWN Rebekah "put the skins of the kids of the goats on his _____ and on the smooth part of his neck." **GENESIS 27:16**
- 3 DOWN Isaac "did not recognize him, because his hands were _____ like his brother Esau's hands; so he blessed him." **GENESIS 27:23**
- 6 DOWN "Then it happened, as soon as Isaac had finished blessing Jacob, and Jacob had scarcely gone out from the presence of Isaac his father, that _____ his brother came in from his hunting." **GENESIS 27:30**
- 1 DOWN Isaac said to Esau, "Your brother came with _____ and has taken away your blessing." **GENESIS 27:35**
- 2 DOWN "So Esau hated _____ because of the blessing with which his father blessed him, and Esau said in his heart, 'The days of mourning for my father are at hand; then I will kill my brother Jacob.' "**GENESIS 27:41**

Bible Story 24

JACOB'S DREAM

GENESIS 28:10-22

24. JACOB'S DREAM (GENESIS 28:10-22)



“And he dreamed, and behold a ladder set up on the earth, and the top of it reached to heaven: and behold the angels of God ascending and descending on it.”

GENESIS 28:12

24. JACOB'S DREAM (GENESIS 28:10-22)

MEMORY VERSE:

"Behold, I am with you and will keep you wherever you go." GENESIS 28:15

CIRCLE THE CORRECT WORDS:

1. "Now Jacob went out from Beersheba and went toward Haran. So he came to a certain place and stayed there all night, because the sun had set. And he took one of the (**TREES, STONES**) of that place and put it at his (**HEAD, FEET**), and he lay down in that place to sleep." **GENESIS 28:10-11**
2. "Then he (**DREAMED, SNORED**), and behold, a (**LADDER, SLIDE**) was set upon the earth, and its top reached to heaven; and there the angels of God were ascending and descending on it." **GENESIS 28:12**

TRUE OR FALSE:

3. "And behold, the LORD stood above it and said: 'I am the LORD God of Abraham your father and the God of Isaac; the land on which you lie I will give to you and your descendants.'" **GENESIS 28:13**

TRUE OR FALSE

4. The LORD also said to Jacob, "Behold, I am with you and will keep you wherever you go, and will bring you back to this land; for I will not leave you until I have done what I have spoken to you." **GENESIS 28:15**

TRUE OR FALSE

FILL IN THE BLANKS:

5. "Then Jacob awoke from his sleep and said, 'Surely the _____ is in this place, and I did not know it.' And he was afraid and said, 'How _____ is this place! This is none other than the house of God, and this is the gate of heaven!' " **GENESIS 28:16-17**

TRUE OR FALSE:

6. "Then Jacob rose early in the morning, and took the stone that he had put at his head, set it up as a pillar, and poured oil on top of it." **GENESIS 28:18**

TRUE OR FALSE

7. Jacob vowed, "This stone which I have set as a pillar shall be God's house, and of all that You give me I will surely give a tenth to You." **GENESIS 28:22**

TRUE OR FALSE

24. JACOB'S DREAM

(GENESIS 28:10-22)

I G T E N T H Q B E S B O L F
B E V I G S C L P R E S N U W
F S R O V V E I M W N L I L H
D V J O X H L P K X O E G E P
U D O Q T L H W E D T E H W J
S F Z E A A S T D A S P T R Y
S M B R R L B M E K C N D E T
D E M A E R D I S Y V E D D P
I V R G C A Y Y S Q Y C O D P
J O N Y P O O T E R C E G A V
A A J M G O C O L V S F D L N
C T Z S A W I X B U A J R A B
O W T B T L K N O B H N O W A
B N M J E C S H M Q L O L M H
O F C H M Y Z Z Q E R Z W B L

ANGELS
JACOB
SLEEP
GATE
OIL

HOUSE
PILLAR
DREAMED
NIGHT

PEACE
BLESSED
LORD GOD
TENTH

BETHEL
LADDER
STONES
GIVE

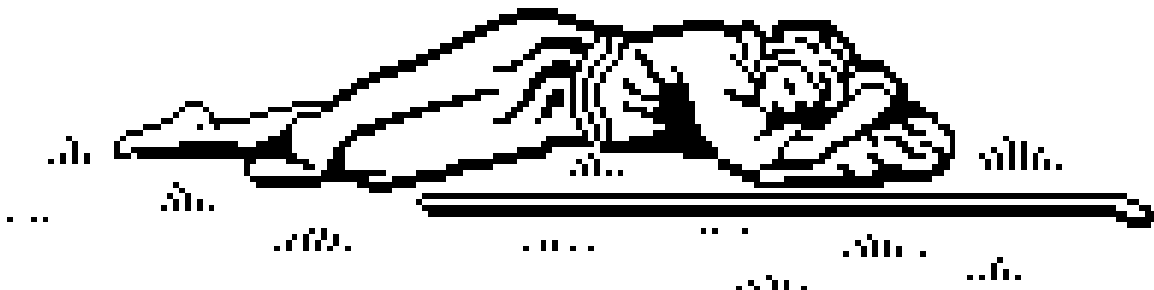

24. JACOB'S DREAM (GENESIS 28:10-22)

MEMORY VERSE:

"Behold, I am with you and will keep you wherever you go." GENESIS 28:15

FILL IN THE BLANKS:

1. "Now Jacob went out from Beersheba and went toward Haran. So he came to a certain place and stayed there all night, because the sun had set. And he took one of the _____ of that place and put it at his _____, and he lay down in that place to sleep." **GENESIS 28:10-11**
2. "Then he _____, and behold, a _____ was set upon the earth, and its top reached to heaven; and there the angels of God were ascending and descending on it." **GENESIS 28:12**

TRUE OR FALSE:

3. "And behold, the LORD stood above it and said: 'I am the LORD God of Abraham your father and the God of Isaac; the land on which you lie I will give to you and your descendants.' "**GENESIS 28:13**

TRUE OR FALSE

4. The LORD also said to Jacob, "Behold, I am with you and will keep you wherever you go, and will bring you back to this land; for I will not leave you until I have done what I have spoken to you." **GENESIS 28:15**

TRUE OR FALSE

FILL IN THE BLANKS:

5. "Then Jacob awoke from his sleep and said, 'Surely the _____ is in this place, and I did not know it.' And he was afraid and said, 'How _____ is this place! This is none other than the house of God, and this is the gate of heaven!' "**GENESIS 28:16-17**
6. "Then Jacob rose early in the morning, and took the stone that he had put at his head, set it up as a _____, and poured _____ on top of it. And he called the name of that place _____, but the name of that city had been Luz previously." **GENESIS 28:18-19**
7. Jacob vowed, "This stone which I have set as a pillar shall be God's _____, and of all that You give me I will surely give a tenth to You." **GENESIS 28:22**

24. JACOB'S DREAM

(GENESIS 28:10-22)

W D E Z B M X K T S G C K E J W R D R K T K I U C
 P P E E L S R K A V E G C J C U L D Y A H O U S E
 P J O E Q X A Q N M U R U K V B W O Y T M S K V M
 W Q V K Y T L J R A W G M K N D E K D W O M X Z P
 Q I O B E Y L B P Z D N D P I D E T J L E O P A O
 G I C Z L L I B I S W G L Z G S J S H A N G E L S
 T J F F N I P R Q H Y Z S Y H J U Q S E M A P U E
 A K A D E M A E R D P J V Y T H O K I E L T U E A
 U T K C V O P B D M Z P R O T Q E L P A L M Z F Y
 U D B H O V E E J K W N C J W O P W T P X B V P U
 H Y Y N Q B T K Q S B U M F H E R E D D A L F T H
 T H N G T A S E R V M O D A P E T K V P N Z R O A
 E U M X G Q G F I O W F L E N W C I R A O J K N E
 N Q H G A Z D J L J U L B O S E S J F L B S K I C
 T S G N I D N E C S A L T H J C C S E V U M Y J N
 H S L R Q U E T S J F S L A H B E U J Q L X R J A
 E I D Q F A P E T E I M A H Q K H N O D P P G Y I
 R L R I H N Z J F A X S C Z O S U E D V M C I T Z
 J S E P P M C Z A W G Z W Y A U E E U I C D K H S
 S J U H J G C Z Y L Y L J N W H C A G S N T L I O
 L O R D G O D K Y Z P P U J V A C V N M C G U G N
 T F W Z T F Q C O X Y G K T E P N D K C V X A F C
 A F J I B H I T F P B K O P M E Q Q D Z Z X V Y Z
 Z O N V I A W I V J D B I P F V L E B L K G X Q X
 S P S V A W Z O X H R U T L S A K N K U F E O D R

ANGELS
 PEACE
 LADDER
 DREAMED

GIVE
 BETHEL
 SLEEP
 NIGHT

OIL
 JACOB
 DESCENDING
 TENTH

ASCENDING
 PILLAR
 LORD GOD
 GATE

HOUSE
 BLESSED
 STONE

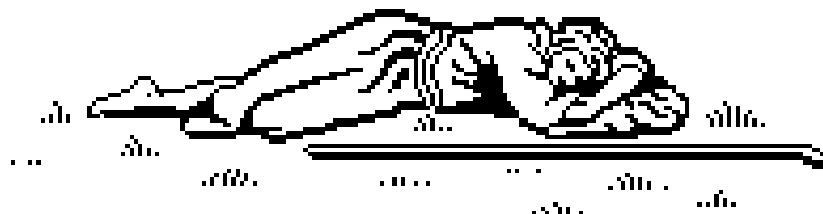

24. JACOB'S DREAM (GENESIS 28:10-22)

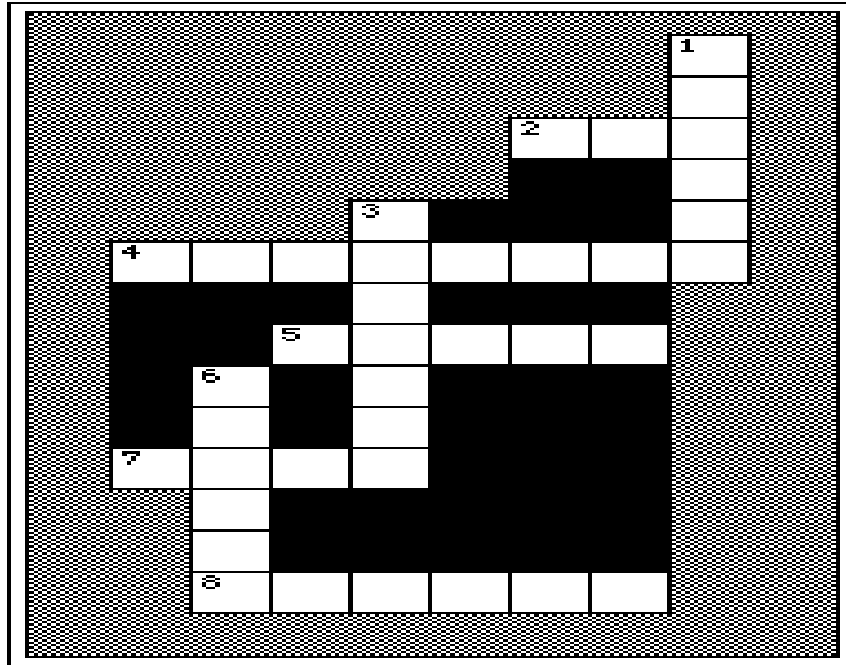

- 4 ACROSS "Behold, I am with you and will keep you _____ you go." **GENESIS 28:15**
- 6 DOWN "Now Jacob went out from Beersheba and went toward Haran. So he came to a certain place and stayed there all night, because the sun had set. And he took one of the _____ of that place and put it at his feet, and he lay down in that place to sleep." **GENESIS 28:10-11**
- 3 DOWN "Then he _____, and behold, a ladder was set upon the earth, and its top reached to heaven; and there the angels of God were ascending and descending on it." **GENESIS 28:12**
- 7 ACROSS "And behold, the _____ stood above it and said: 'I am the LORD God of Abraham your father and the God of Isaac; the land on which you lie I will give to you and your descendants.'" **GENESIS 28:13**
- 8 ACROSS The LORD also said to Jacob, "Behold, I am with you and will keep you wherever you go, and will bring you back to this land; for I will not leave you until I have done what I have _____ to you." **GENESIS 28:15**
- 5 ACROSS "Then _____ awoke from his sleep and said, 'Surely the LORD is in this place, and I did not know it.' And he was afraid and said, 'How awesome is this place! This is none other than the house of God, and this is the gate of heaven!' " **GENESIS 28:16-17**
- 2 ACROSS "Then Jacob rose early in the morning, and took the stone that he had put at his head, set it up as a pillar, and poured _____ on top of it." **GENESIS 28:18**
- 1 DOWN Jacob vowed, "This stone which I have set as a _____ shall be God's house, and of all that You give me I will surely give a tenth to You." **GENESIS 28:22**

Bible Story 25

LEAH & RACHEL

GENESIS 29:1-30

25. LEAH & RACHEL (GENESIS 29:1-30)

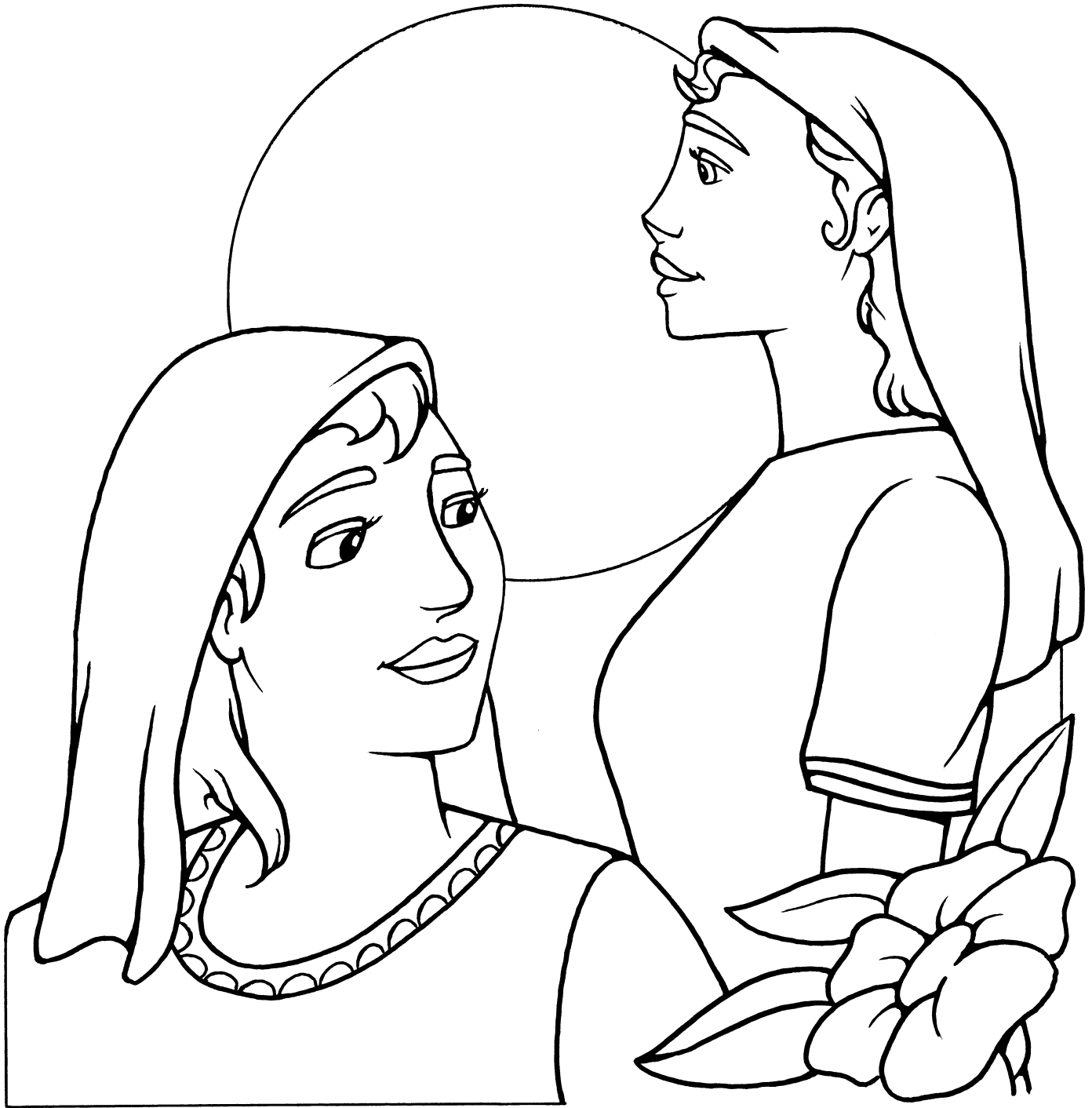

“And Laban had two daughters: the name of the elder was Leah, and the name of the younger was Rachel.”

GENESIS 29:16

25. LEAH & RACHEL (GENESIS 29:1-30)

MEMORY VERSE:

"The wicked man does deceptive work, but to him who sows righteousness will be a sure reward." PROVERBS 11:18

CIRCLE THE CORRECT WORDS:

1. "And it came to pass, when Jacob saw (**REBEKAH, RACHEL**) the daughter of Laban his mother's brother, and the (**COWS, SHEEP**) of Laban his mother's brother, that Jacob went near and rolled the stone from the well's mouth, and watered the flock of Laban his mother's brother." **GENESIS 29:10**
2. "And Jacob told Rachel that he was her father's relative and that he was Rebekah's son. So she (**RAN, WALKED**) and told her father." **GENESIS 29:12**

FILL IN THE BLANKS:

3. "Now Laban had two daughters: the name of the elder was _____, and the name of the younger was _____." **GENESIS 29:16**

TRUE OR FALSE:

4. "Leah's eyes were delicate, but Rachel was beautiful of form and appearance." **GENESIS 29:17**
TRUE OR FALSE
5. "Now Jacob loved Rachel; and he said, 'I will serve you seven years for Rachel your younger daughter.' " **GENESIS 29:18**
TRUE OR FALSE

CIRCLE THE CORRECT WORDS:

6. "So Jacob served seven years for Rachel, and they seemed but a few (**DAYS, YEARS**) to him because of the love he had for her." **GENESIS 29:20**
7. When Laban tricked Jacob into marrying his older daughter Leah, Jacob asked, "What is this you have done to me? Was it not for Rachel that I served you? Why then have you (**DECEIVED, BELIEVED**) me?" **GENESIS 29:25**
8. "And (**LABAN, YUBAN**) said, 'It must not be done so in our country, to give the younger before the firstborn.' " **GENESIS 29:26**
9. Now Jacob "loved Rachel more than Leah. And he served with Laban still another (**SEVEN, SEVENTY**) years." **GENESIS 29:30**

25. LEAH & RACHEL

(GENESIS 29:1-30)

V T J N Q P E F A M V W I F E
 I Q K A S N P O G J B K C N W
 O D S S T R I J W K G R C Y L
 N H E Y H K A R A C H E L M W
 L A M V H E Y E A G C E H A W
 O U J Q I B P S Y E V R E S Z
 R U T S T E N H F N Z N R S O
 D T A S T O C R E N E C E V A
 H T A K S O B E O R E V M Y K
 I D N C T C N W D B D R E K L
 U D E O L D B E U J T E R S N
 A Q N L R O P S L H A S S A U
 F C Q F R W V S T E H C R S B
 L A B A N K P E O G A V O I D
 F U N U W I Y I D D K H Q B F

BARREN
 DECEIVED
 FIRSTBORN
 FLOCKS
 JACOB
 LABAN

LEAH
 LORD
 LOVED
 RACHEL
 SERVE

SEVEN YEARS
 SHEPHERDESS
 SONS
 STONE
 WIFE

WRITE DOWN THE LETTERS AS YOU COME TO THEM ON THE LINES BELOW

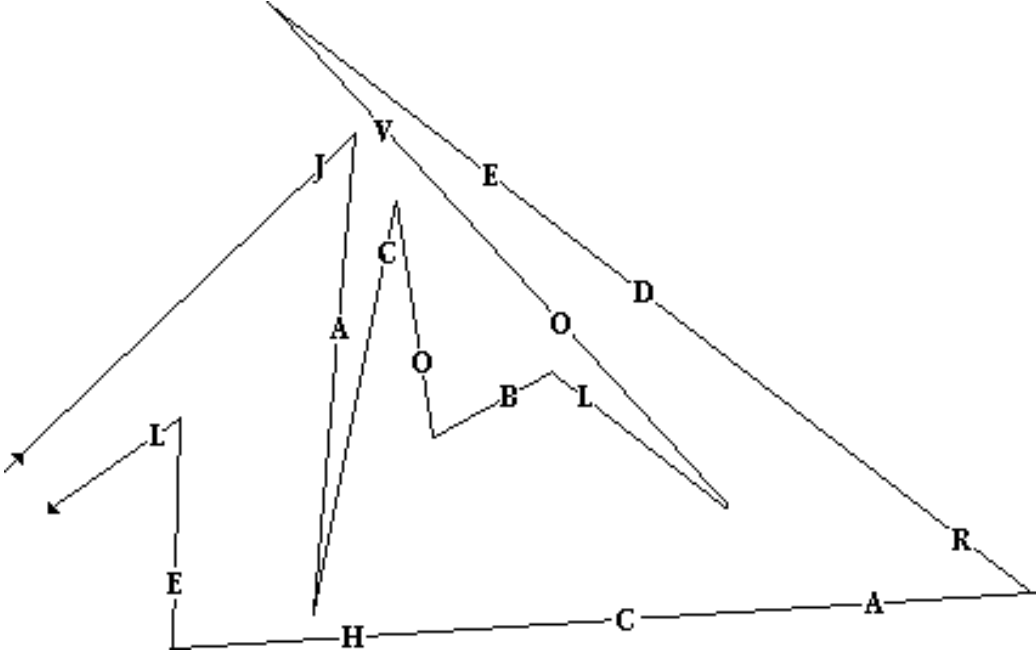

25. LEAH & RACHEL (GENESIS 29:1-30)

MEMORY VERSE:

"The wicked man does deceptive work, but to him who sows righteousness will be a sure reward." PROVERBS 11:18

FILL IN THE BLANKS:

1. "And it came to pass, when _____ saw _____ the daughter of Laban his mother's brother, and the _____ of Laban his mother's brother, that Jacob went near and rolled the stone from the well's mouth, and watered the flock of Laban his mother's brother."
GENESIS 29:10
2. "And Jacob told Rachel that he was her father's relative and that he was Rebekah's son. So she _____ and told her father." **GENESIS 29:12**
3. "Now Laban had two daughters: the name of the elder was _____, and the name of the younger was _____." **GENESIS 29:16**

TRUE OR FALSE:

4. "Leah's eyes were delicate, but Rachel was beautiful of form and appearance."
GENESIS 29:17
TRUE OR FALSE
5. "Now Jacob loved Rachel; and he said, 'I will serve you seven years for Rachel your younger daughter.' "**GENESIS 29:18**
TRUE OR FALSE

CIRCLE THE CORRECT WORDS:

6. "So Jacob served seven years for Rachel, and they seemed but a few (**DAYS, YEARS**) to him because of the love he had for her." **GENESIS 29:20**
7. When Laban tricked Jacob into marrying his older daughter Leah, Jacob asked, "What is this you have done to me? Was it not for Rachel that I served you? Why then have you (**DECEIVED, BELIEVED**) me?" **GENESIS 29:25**

FILL IN THE BLANKS:

8. "And Laban said, 'It must not be done so in our country, to give the younger before the _____.'" **GENESIS 29:26**
9. Now Jacob "loved Rachel more than Leah. And he served with Laban still _____ seven years." **GENESIS 29:30**

25. LEAH & RACHEL

(GENESIS 29:1-30)

T Z D J Z D O V U G N N C F H Q P U J V
 B E N O T S F O L Y U M W A P O E E S R
 I U E B K J V E W P O L N H J E V C U F
 A A P B C Q A J D Y F O J E H W A N E E
 M S O N S H L J W B L V U A R E R Q A J
 F N N R O B T S R I F E K H Q R L L V O
 N L Z R T R S E Y D L D O Z O B A K D U
 T M O B I I V A P R M D I Y A K W B Q G
 Y G C C O L M W Z C S L T L E H C A R F
 S F C K K S A L W G Z S E N W S J D E L
 E H Q E T S Z Z B R F V J J V U U D N D
 R S S E D R E H P E H S K T M D O O R B
 V A I F A E F I W G P R K P F E L K Y K
 E W W J N T S M M N G C P L S V E O Y K
 L X Z T R F H P W G K M Z J W I P Q R A
 I P K E P A M J U Z B L Y N U E T K D D
 S E V E N Y E A R S U B A C D C C L J T
 O E K J I Y L H F J K B Y V S E S W I W
 V S B O C A J G I P A X O T J D C K P L
 Q G Q Z Q Y S E M L C A J W H H H I T A

BARREN
 DECEIVED
 FIRSTBORN
 FLOCKS
 JACOB
 LABAN

LEAH
 LORD
 LOVED
 RACHEL
 SERVE

SEVEN YEARS
 SHEPHERDESS
 SONS
 STONE
 WIFE

WRITE DOWN THE LETTERS AS YOU COME TO THEM ON THE LINES BELOW

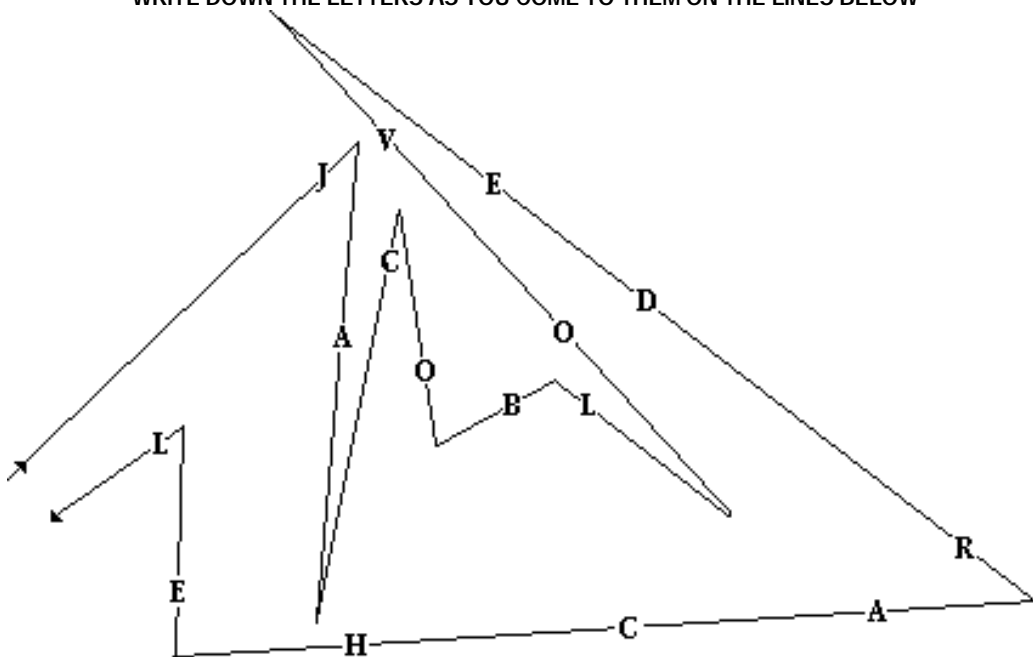

25. LEAH & RACHEL (GENESIS 29:1-30)

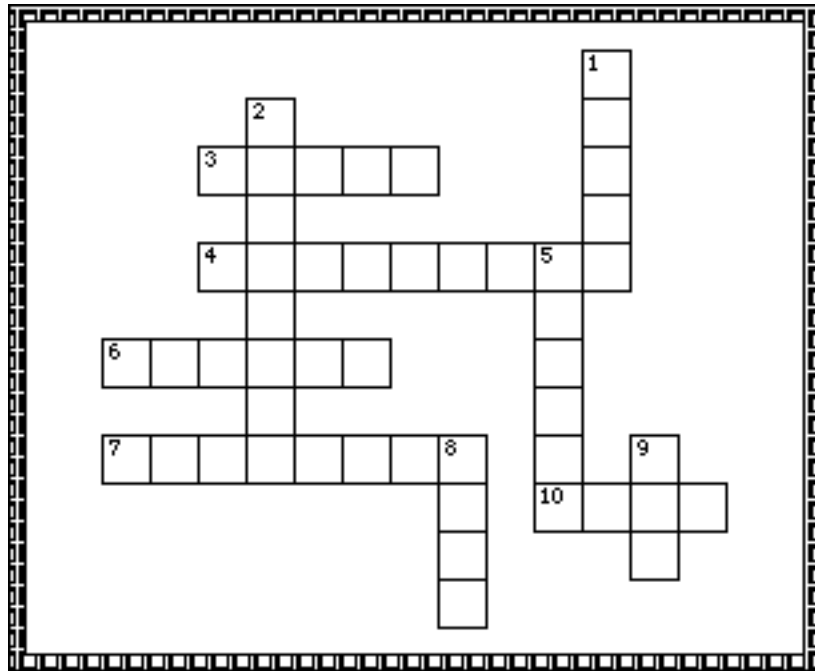

- 6 ACROSS "The wicked man does deceptive work, but to him who sows righteousness will be a sure _____. " **PROVERBS 11:18**
- 5 DOWN "And it came to pass, when Jacob saw _____ the daughter of Laban his mother's brother, and the sheep of Laban his mother's brother, that Jacob went near and rolled the stone from the well's mouth, and watered the flock of Laban his mother's brother." **GENESIS 29:10**
- 9 DOWN "And Jacob told Rachel that he was her father's relative and that he was Rebekah's son. So she _____ and told her father." **GENESIS 29:12**
- 10 ACROSS "Now Laban had two daughters: the name of the elder was _____, and the name of the younger was Rachel." **GENESIS 29:16**
- 2 DOWN "Leah's eyes were _____, but Rachel was beautiful of form and appearance." **GENESIS 29:17**
- 3 ACROSS "Now Jacob loved Rachel; and he said, 'I will _____ you seven years for Rachel your younger daughter.' " **GENESIS 29:18**
- 8 DOWN "So Jacob served seven years for Rachel, and they seemed but a few _____ to him because of the love he had for her." **GENESIS 29:20**
- 7 ACROSS When Laban tricked Jacob into marrying his older daughter Leah, Jacob asked, "What is this you have done to me? Was it not for Rachel that I served you? Why then have you _____ me?" **GENESIS 29:25**
- 4 ACROSS "And Laban said, 'It must not be done so in our country, to give the younger before the _____.'" **GENESIS 29:26**
- 1 DOWN Now Jacob "loved Rachel more than Leah. And he served with Laban still another _____ years." **GENESIS 29:30**

Bible Story 26

THE SONS OF JACOB

GENESIS 29:31-30:24; 35:16-26

26. THE SONS OF JACOB

(GENESIS 29:31-30:24; 35:16-26)



"Behold, children are a heritage from the LORD."

PSALM 127:3

"Happy is the man who has his quiver full of them."

PSALM 127:5

26. THE SONS OF JACOB (GENESIS 29:31-30:24; 35:16-26)

MEMORY VERSE:

"Behold, children are a heritage from the LORD." PSALM 127:3

"Happy is the man who has his quiver full of them." PSALM 127:5

MATCHING:

MATCH THE NAME OF JACOB'S SON ON THE RIGHT TO ITS MEANING ON THE LEFT

- | | | | |
|-----|-----|--|-------------|
| 1. | ___ | "The LORD has surely looked on my affliction.
Now therefore my husband will love me." GENESIS 29:32 | A. LEVI |
| 2. | ___ | "Because the LORD has heard that I am unloved,
He has given me this son also." GENESIS 29:33 | B. NAPHTALI |
| 3. | ___ | "Now this time my husband will become attached to me,
because I have borne him three sons." GENESIS 29:34 | D. BENJAMIN |
| 4. | ___ | "Now I will praise the LORD." GENESIS 29:35 | E. ASHER |
| 5. | ___ | "God has judged my case; and He has heard my voice
and given me a son." GENESIS 30:6 | F. REUBEN |
| 6. | ___ | "With great wrestlings I have wrestled with my sister,
and indeed I have prevailed." GENESIS 30:8 | H. JUDAH |
| 7. | ___ | "A troop comes!" GENESIS 30:11 | I. JOSEPH |
| 8. | ___ | "I am happy, for the daughters will call me blessed." GENESIS 30:13 | J. SIMEON |
| 9. | ___ | "God has given me my hire,
because I have given my maid to my husband." GENESIS 30:18 | K. ZEBULUN |
| 10. | ___ | "God has endowed me with a good endowment;
now my husband will dwell with me,
because I have borne him six sons." GENESIS 30:20 | L. GAD |
| 11. | ___ | "The LORD shall add to me another son." GENESIS 30:24 | |
| 12. | ___ | She called his name "Ben-Oni" GENESIS 35:18 | |

26. THE SONS OF JACOB

(GENESIS 29:31-30:24; 35:16-26)

G B K V L H A M C T I H N T A
S O S J N J I S S A C H A R A
N N P N O U V Q J N T F H T U
B H O S A Q L S W D R E H S A
K S E E V P C U Y R A V I D E
K P P R M I H Q B A L N U D N
H S R G D I A T J E B I A Q Q
O R N H A L S V A Z Z M F P N
J R O A D D L P T L Z A F U N
Q V E D Z H O B N E I J T J A
S N S U Z T Z Q A M Z N Q K Y
P G L J B Y M J S D N E H S Q
M D K W N E F I L W K B A M U
L E V I O A N C P Q O I U J Q
B P W E W O D T U X B O U T T

ASHER
BENJAMIN
DAN
GAD

ISSACHAR
JOSEPH
JUDAH
LEVI

NAPHTALI
REUBEN
SIMEON
ZEBULUN



"Happy is the man who has his quiver full of them." PSALM 127:5

26. THE SONS OF JACOB (GENESIS 29:31-30:24; 35:16-26)

MEMORY VERSE:

"Behold, children are a heritage from the LORD." PSALM 127:3

"Happy is the man who has his quiver full of them." PSALM 127:5

FILL IN THE BLANKS::

WRITE THE NAME OF JACOB'S SON ON THE RIGHT NEXT TO ITS MEANING ON THE LEFT

1. "The LORD has surely looked on my affliction. Now therefore my husband will love me."
GENESIS 29:32 _____
2. "Because the LORD has heard that I am unloved, He has given me this son also."
GENESIS 29:33 _____
3. "Now this time my husband will become attached to me, because I have borne him three sons." **GENESIS 29:34** _____
4. "Now I will praise the LORD." **GENESIS 29:35** _____
5. "God has judged my case; and He has heard my voice and given me a son."
GENESIS 30:6 _____
6. "With great wrestlings I have wrestled with my sister, and indeed I have prevailed."
GENESIS 30:8 _____
7. "A troop comes!" **GENESIS 30:11** _____
8. "I am happy, for the daughters will call me blessed." **GENESIS 30:13** _____
9. "God has given me my hire, because I have given my maid to my husband."
GENESIS 30:18 _____
10. "God has endowed me with a good endowment; now my husband will dwell with me, because I have borne him six sons." **GENESIS 30:20** _____
11. "The LORD shall add to me another son." **GENESIS 30:24** _____
12. She called his name "Ben-Oni" **GENESIS 35:18** _____

26. THE SONS OF JACOB (GENESIS 29:31-30:24; 35:16-26)

E M N P I J M H S R O V N L W M S O G S U Z P Q M
 D W B P L I D I M R J B Y U Q U O U H Q B F Z N P
 P N K R H C W U N W W G M F N L T I X U N Z F R M
 U G K X T N Q A D O S R E U B E N I V M H N V P L
 G K O O Y T A A J P E C A L I S W B S J X D F W C
 I B J S O C N P T N S M S Y S E I R U Q A K H B S
 C Y Q L A J X F H K I Z I H V J H W H P E S O J G
 E K S K V W I F A T A H V S U M J G X L U L N I E
 U P P W C Y T T A B A K Y X U G I T H J V U E F Y
 X U M V A J A Q U C G L K O A O S K U N A Y E W U
 M Y B J L T L H E D H K I I D V S W Q U E E M L W
 K F B X O N B A N W W A W R D S A I T L I E J J I
 U K O W Z A Z U Q K A R D F W P C U P U S J Q B A
 Y T G E M S Z U X I F E L U T T H M L B G A V B C
 Y G H A F L N B N E U N W Y J W A F J E J V E K L
 R E S L D P K T E P T C W X L B R O B Z P K V J P
 F Y S V M U O T A N O V Z D A H D E J T Z U V K A
 H G R D Q T B D Y I J C O F O J R P H W F O L U I
 E M V D S N H D Q Y M A A B A Y E K T K B Z A M E
 L Q N Z Q D F Q U B J C M E P K H J J M X X I X Y
 M H G Z V R V C Q B K H K I A P S N Y L K A L Y A
 G V D O P A I I T P G R U H N G A R R U M M R R Q
 M V P W B Z V U H P H E N T D K U T D G Z Z U T A
 B G K H Q E O J T Y G M U L Y G O W C C X B U T O
 P S S Q L E N K T F D Q D U S P L U G V I T C C Y

ASHER
 BENJAMIN
 DAN
 GAD

ISSACHAR
 JOSEPH
 JUDAH
 LEVI

NAPHTALI
 REUBEN
 SIMEON
 ZEBULUN



"Happy is the man who has his quiver full of them." PSALM 127:5

26. THE SONS OF JACOB (GENESIS 29:31-30:24; 35:16-26)

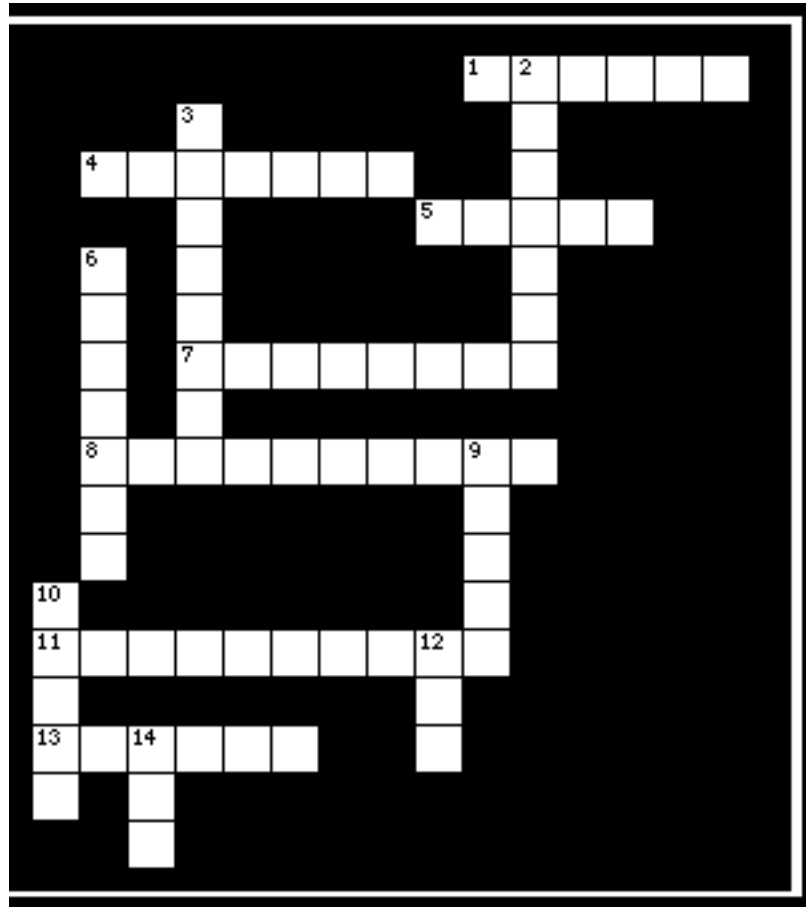

- 3 DOWN "Behold, children are a _____ from the LORD." **PSALM 127:3**
- 10 DOWN "_____ is the man who has his quiver full of them." **PSALM 127:5**
- 11 ACROSS "The LORD has surely looked on my _____. Now therefore my husband will love me." **GENESIS 29:32**
- 2 DOWN "Because the LORD has heard that I am _____. He has given me this son also." **GENESIS 29:33**
- 7 ACROSS "Now this time my husband will become _____ to me, because I have borne him three sons." **GENESIS 29:34**
- 13 ACROSS "Now I will _____ the LORD." **GENESIS 29:35**
- 1 ACROSS "God has _____ my case; and He has heard my voice and given me a son." **GENESIS 30:6**
- 8 ACROSS "With great _____ I have wrestled with my sister, and indeed I have prevailed." **GENESIS 30:8**
- 5 ACROSS "A _____ comes!" **GENESIS 30:11**
- 4 ACROSS "I am happy, for the daughters will call me _____" **GENESIS 30:13**
- 9 DOWN "God has _____ me my hire, because I have given my maid to my husband." **GENESIS 30:18**
- 6 DOWN "God has _____ me with a good endowment; now my husband will dwell with me, because I have borne him six sons." **GENESIS 30:20**
- 14 DOWN "The LORD shall _____ to me another son." **GENESIS 30:24**
- 12 DOWN She called his name "Ben-_____." **GENESIS 35:18**

Bible Story 27

**YOUR NAME
SHALL BE ISRAEL**

GENESIS 32:22-32

27. YOUR NAME SHALL BE ISRAEL (GENESIS 32:22-32)

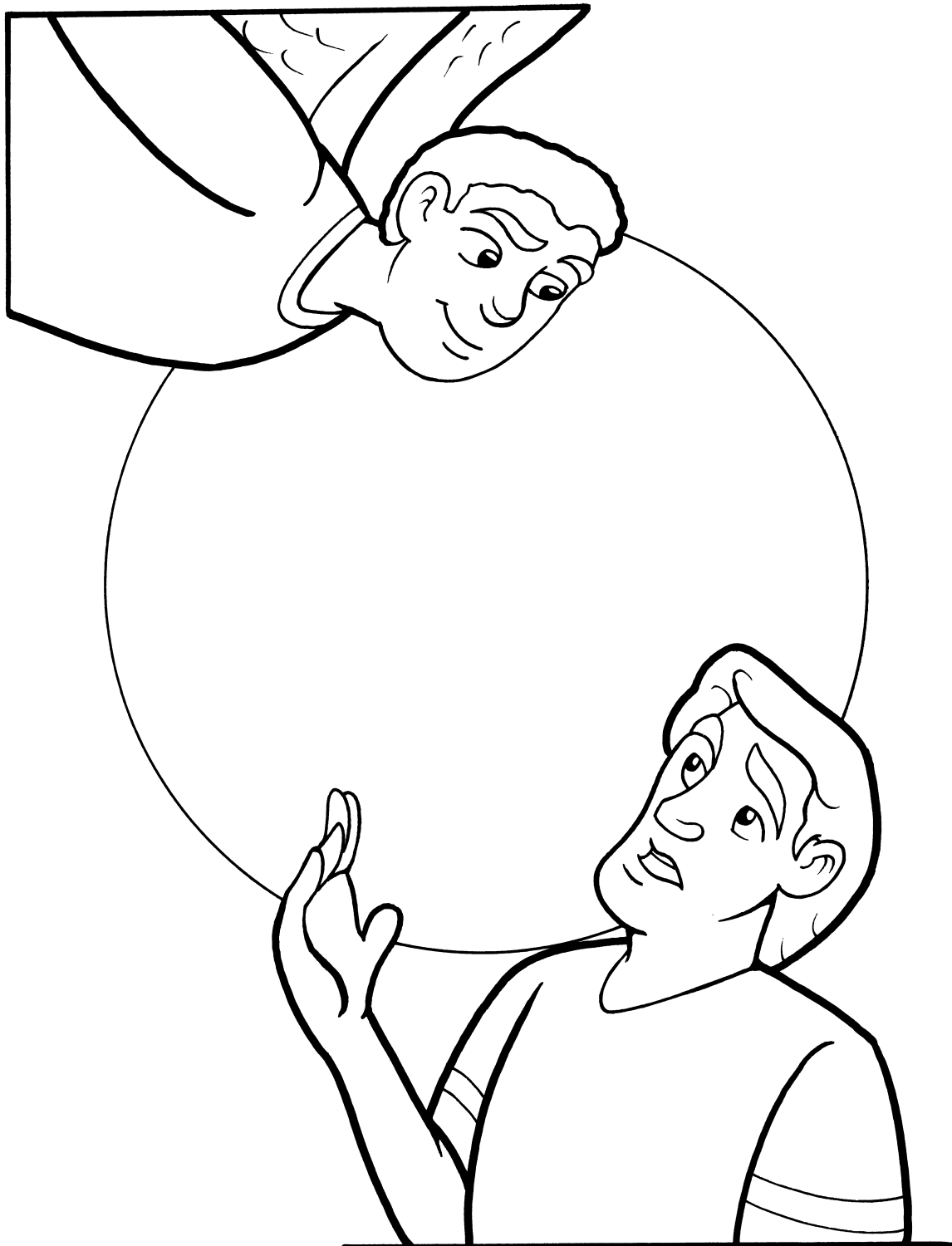

“And he said unto him, What *is* thy name? And he said, Jacob. And he said, Thy name shall be called no more Jacob, but Israel: for as a prince hast thou power with God and with men, and hast prevailed.”

GENESIS 32:27-28

27. YOUR NAME SHALL BE ISRAEL

(GENESIS 32:22-32)

MEMORY VERSE:

"The LORD is near to all who call upon Him, to all who call upon Him in truth."
PSALM 145:18

TRUE OR FALSE:

1. "Jacob was left alone; and a Man wrestled with him until the breaking of day." **GENESIS 32:24**
TRUE OR FALSE

CIRCLE THE CORRECT WORDS:

2. "Now when He saw that He did not prevail against him, He touched the socket of his (**WRENCH, HIP**); and the socket of Jacob's (**WRENCH, HIP**) was out of joint as He wrestled with him." **GENESIS 32:25**
3. "And He said, 'Let Me go, for the day breaks.' But he said, 'I will not let You go unless You (**BLESS, PUNCH**) me!' " **GENESIS 32:26**

TRUE OR FALSE:

4. So He said to him, "What is your name?" And he said, "Joebob." **GENESIS 32:27**
TRUE OR FALSE

FILL IN THE BLANKS:

5. "And He said, 'Your name shall no longer be called _____, but _____; for you have struggled with God and with men, and have prevailed.'" **GENESIS 32:28**

TRUE OR FALSE:

6. "Then Jacob asked Him, saying, 'Tell me Your name, I pray.' And He said, 'Why is it that you ask about My name?' And He blessed him there." **GENESIS 32:29**
TRUE OR FALSE

CIRCLE THE CORRECT WORDS:

7. "And Jacob called the name of the place Peniel: 'For I have seen God face to face and my life is (**PRESERVED, DESTROYED**).'" **GENESIS 32:30**
8. "Just as he crossed over Penuel the sun rose on him, and he (**JUMPED, LIMPED**) on his hip." **GENESIS 32:31**

27. YOUR NAME SHALL BE ISRAEL

(GENESIS 32:22-32)

G L E A R S I J G B Y J O M B
 B O T D T V S E E M B P L S L
 K J D K O O R B N K U N L U A
 E B L E S S H A U A N S M M N
 F Z D E L T S E R W M A C D W
 J Z A J F D M W W M D E R L J
 S K N Q A S D L D W R U S H E
 O C R R Y V S Z W U C O Z L S
 C E C A F O T E C A F D F S U
 K N A M B O C A J F N E P V M
 E T P I Y M V X Y I R H G R O
 T I I L O A O P P X G C K C I
 P R E V A I L E D G N U B M T
 T O Q S F Z J J Z Y G O U L E
 E D E P M I L H W P Z T H I P

BLESS
 BROOK
 FACE TO FACE
 GOD
 HIP
 ISRAEL

JACOB
 LIMPED
 MAN
 MUSCLE
 NAME

PREVAILED
 SHRANK
 SOCKET
 TOUCHED
 WRESTLED

WRITE DOWN THE LETTERS AS YOU COME TO THEM ON THE LINES BELOW

→		C			L		U	
		A		L				
		R		I	M	P		O
	U		T	N		H		
		T	H		I			N

27. YOUR NAME SHALL BE ISRAEL (GENESIS 32:22-32)

MEMORY VERSE:

"The LORD is near to all who call upon Him, to all who call upon Him in truth."
PSALM 145:18

TRUE OR FALSE:

1. "Jacob was left alone; and a Man wrestled with him until the breaking of day." **GENESIS 32:24**
TRUE OR FALSE

FILL IN THE BLANKS:

2. "Now when He saw that He did not prevail against him, He touched the socket of his _____; and the socket of Jacob's _____ was out of joint as He wrestled with him." **GENESIS 32:25**
3. "And He said, 'Let Me go, for the day breaks.' But he said, 'I will not let You go unless You _____ me!' " **GENESIS 32:26**

TRUE OR FALSE:

4. So He said to him, "What is your name?" And he said, "Joebob." **GENESIS 32:27**
TRUE OR FALSE

FILL IN THE BLANKS:

5. "And He said, 'Your name shall no longer be called _____, but _____; for you have struggled with God and with men, and have prevailed.'" **GENESIS 32:28**

TRUE OR FALSE:

6. "Then Jacob asked Him, saying, 'Tell me Your name, I pray.' And He said, 'Why is it that you ask about My name?' And He blessed him there." **GENESIS 32:29**
TRUE OR FALSE

FILL IN THE BLANKS:

7. "And Jacob called the name of the place Peniel: 'For I have seen God face to face and my life is _____.'" **GENESIS 32:30**
8. "Just as he crossed over Penuel the sun rose on him, and he _____ on his hip." **GENESIS 32:31**

27. YOUR NAME SHALL BE ISRAEL

(GENESIS 32:22-32)

C Q Z P V U Z K T T K Q S S L W P X W Q M M J N D
 B E D U D F Q U Y E Y W G Z T Q B S A U B N R V K
 G Y J E S I Q A I F J T V U E I W D W G X B L R W
 Z R V D L O A B M P W F O P H Z N Y F S W U W T Z
 F E U V O T C J X H R O Q F S J K Q L Z C T D O Y
 S H H U J Q S K T N F E B H B R A T L G S O C R F
 M X B B P V J E E E L G V T S Q V Q F U S U G T T
 I H O D V Q W J R T Q B A A L T I I H G E C H H N
 Q X V I R M M B X W L K Z J I D E R N N L H E N R
 J C B Q U F B U L M J H N A J L O H S N B E U A S
 M V E S X I Q R M M N N T C G V E G C H S D E J K
 E A C C Y I S Z O A D O B O E X D D A D H C L E Z
 W L E D D G M R M O O J Q B A U Y D V N F N P X Q
 E O M Q J D Z S P T K D X A R Z N H N I A C M I C
 Z U Y T F G E K Y F I Z V K C N X Z K J C H I K K
 P O Q I T O E A A Q T A Z T X Z Y W M Z E I J H H
 N C M W F S M L A Y L S C J E I M V M X T U L C D
 V C A S C R A X K U R E A P F O A C K E O E S O S
 E K C H X P N D L J D B A V Q U A D F G F C Q T B
 T Y G S T H P I E T J V Q R Y E P R M Y A G O N J
 C D J C B K M B C A J J U B S U Q B K S C M Y D V
 V D H O E P G J O W Z R R Z R I F Q P V E V Q J H
 T U W N E E M O I L P H B U V M A T M N I E F L I
 L M F D L H T N Z S H R A N K Z D Y V H B F T B P
 S Y R V X R M O Z R D L E P B S N P D U O E H O A

BLESS
 BROOK
 FACE TO FACE
 GOD
 HIP
 ISRAEL

JACOB
 LIMPED
 MAN
 MUSCLE
 NAME

PREVAILED
 SHRANK
 SOCKET
 TOUCHED
 WRESTLED

WRITE DOWN THE LETTERS AS YOU COME TO THEM ON THE LINES BELOW

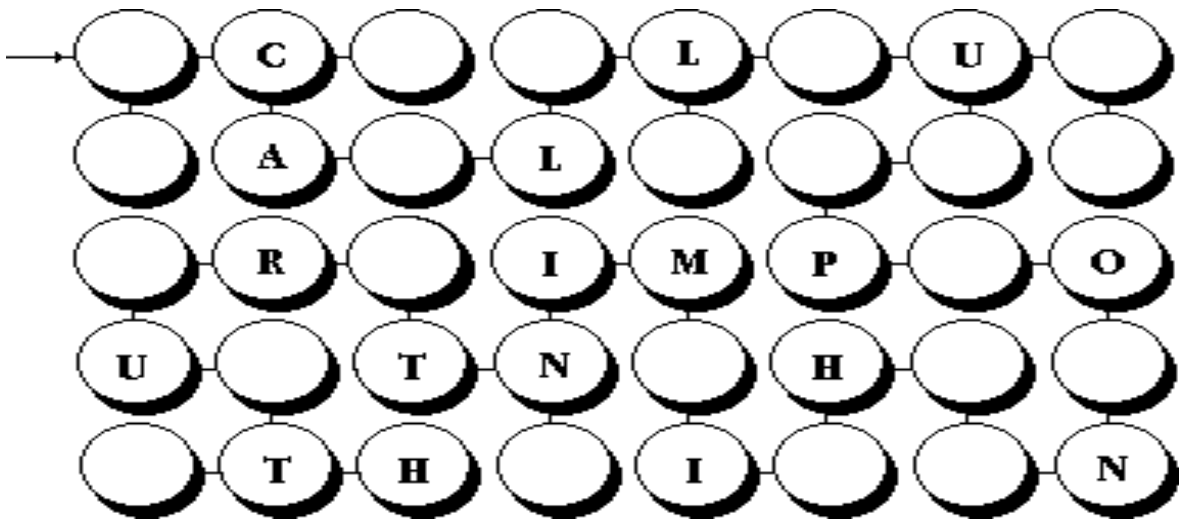

27. YOUR NAME SHALL BE ISRAEL

(GENESIS 32:22-32)

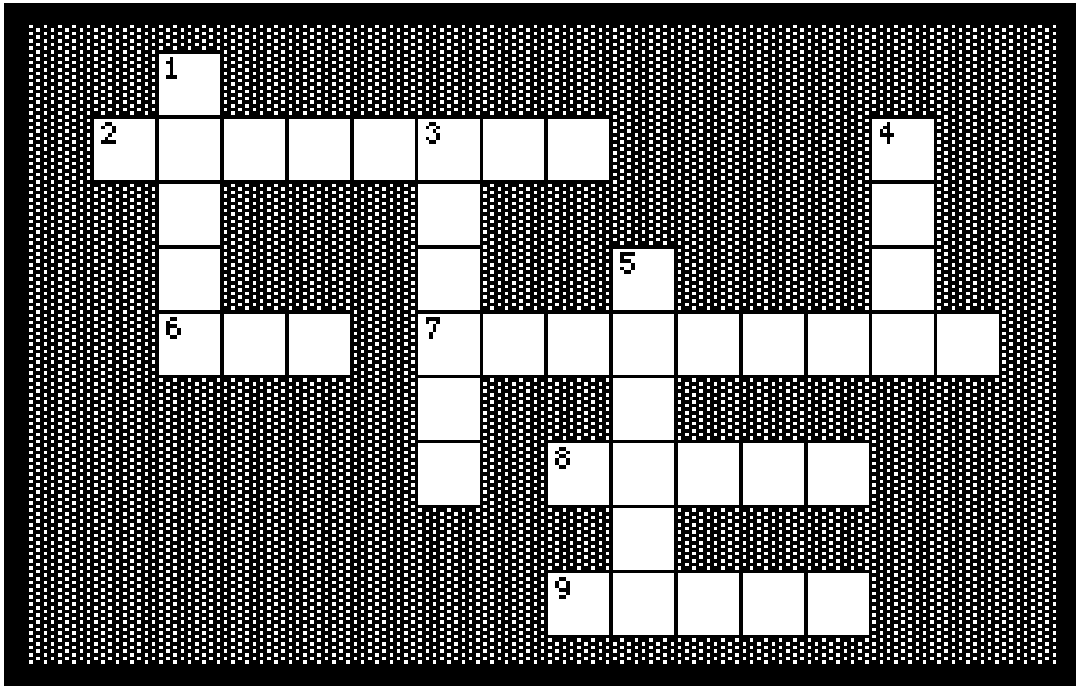

- 1 DOWN "The LORD is near to all who call upon Him, to all who call upon Him in ____." **PSALM 145:18**
- 2 ACROSS "Jacob was left alone; and a Man _____with him until the breaking of day." **GENESIS 32:24**
- 6 ACROSS "Now when He saw that He did not prevail against him, He touched the socket of his ____; and the socket of Jacob's hip was out of joint as He wrestled with him." **GENESIS 32:25**
- 9 ACROSS "And He said, 'Let Me go, for the day breaks.' But he said, 'I will not let You go unless You _____ me!' " **GENESIS 32:26**
- 8 ACROSS So He said to him, "What is your name?" And he said, "_____." **GENESIS 32:27**
- 5 DOWN "And He said, 'Your name shall no longer be called Jacob, but ____; for you have struggled with God and with men, and have prevailed.'" **GENESIS 32:28**
- 4 DOWN "Then Jacob asked Him, saying, 'Tell me Your _____ I pray.' And He said, 'Why is it that you ask about My name?' And He blessed him there." **GENESIS 32:29**
- 7 ACROSS "And Jacob called the name of the place Peniel: 'For I have seen God face to face and my life is _____.'" **GENESIS 32:30**
- 3 DOWN "Just as he crossed over Penuel the sun rose on him, and he _____ on his hip." **GENESIS 32:31**

Bible Story 28

**JOSEPH IS SOLD BY
HIS BROTHERS**

GENESIS 37:3-36

28. JOSEPH IS SOLD BY HIS BROTHERS (GENESIS 37:3-36)



"Then there passed by Midianites merchantmen; and they drew and lifted up Joseph out of the pit, and sold Joseph to the Ishmeelites for twenty *pieces* of silver: and they brought Joseph into Egypt."

GENESIS 37:28

28. JOSEPH IS SOLD BY HIS BROTHERS

(GENESIS 37:3-36)

MEMORY VERSE:

"Blessed are you when they revile and persecute you, and say all kinds of evil against you falsely for My sake." MATTHEW 5:11

CIRCLE THE CORRECT WORDS:

1. "Now Israel loved Joseph (**MORE, LESS**) than all his children, because he was the son of his old age. Also he made him a tunic of many (**BUTTONS, COLORS**)." **GENESIS 37:3**

FILL IN THE BLANKS:

2. "But when his brothers saw that their father _____ him more than all his brothers, they _____ him and could not speak peaceably to him." **GENESIS 37:4**

TRUE OR FALSE:

3. "Now Joseph dreamed a dream, and he told it to his brothers; and they hated him even more." **GENESIS 37:5**
TRUE OR FALSE
4. Joseph had no more dreams and his brothers then began to love him. **GENESIS 37:9**
TRUE OR FALSE

CIRCLE THE CORRECT WORDS:

5. "Then his brothers went to feed their father's flock in Shechem. And Israel said to Joseph, 'Are not your brothers (**FEEDING, EATING**) the flock in Shechem? Come, I will send you to them.' So he said to him, 'Here I am.'" **GENESIS 37:12-13**
6. "Now when they saw him afar off, even before he came near them, they conspired against him to kill him. Then they said to one another, 'Look, this (**SCREAMER, DREAMER**) is coming! Come therefore, let us now kill him and cast him into some (**JAIL PIT**); and we shall say, "Some wild beast has devoured him." We shall see what will become of his dreams!' " **GENESIS 37:18-20**

TRUE OR FALSE:

7. "And Reuben said to them, 'Shed no blood, but cast him into this pit which is in the wilderness, and do not lay a hand on him' - that he might deliver him out of their hands, and bring him back to his father." **GENESIS 37:22**
TRUE OR FALSE

FILL IN THE BLANKS:

8. "Then Midianite traders passed by; so the brothers pulled Joseph up and lifted him out of the pit, and _____ him to the Ishmaelites for twenty shekels of silver. And they took Joseph to _____." **GENESIS 37:28**

CIRCLE THE CORRECT WORDS:

9. "Then they sent the tunic of many colors, and they brought it to their father and said, 'We have found this. Do you know whether it is your son's tunic or not? And he recognized it and said, 'It is my son's tunic. A wild beast has devoured him. Without doubt (**JOSEPH, REUBEN**) is torn to pieces.' " **GENESIS 37:32-33**
10. "And all his sons and all his daughters arose to comfort him; but he (**REFUSED, ACCEPTED**) to be comforted, and he said, 'For I shall go down into the grave to my son in mourning.' Thus his father wept for him." **GENESIS 37:35**

28. JOSEPH IS SOLD BY HIS BROTHERS (GENESIS 37:3-36)

S I L V E R J U D A H N P A G
 H J T J R T N P I T F H O M Z
 Y Q P A G U F S Z L H W E O S
 Q N V H S S R O L O C Y N A M
 K E E N S E I R V H J S I H M
 G B H S H E A V E S A R N L A
 O U T T L S T A K L K T A A E
 J E O A L T L I B B Z V E Z R
 M R L R E O O U L K T B V D D
 B E C S S Y V V M E W A T Y L
 N P K Y H P E S O J A U O E B
 R G C W I T D W S N N M A G E
 M G A C K T Y A H I W R H E W
 I L S B O W E D C P S K I S G
 F Y N N F G M T J I V G W K I

BOWED
 BROTHERS
 DREAM
 GOAT
 HATED
 ISHMAELITES

ISRAEL
 JOSEPH
 JUDAH
 LOVED
 MANY COLORS

MOON
 PIT
 REUBEN
 SACKCLOTH
 SELL

SHEAVES
 SILVER
 STARS
 SUN
 TUNIC



REMOVE JOSEPH FROM THE PIT
AND HELP HIM GET TO EGYPT



28. JOSEPH IS SOLD BY HIS BROTHERS

(GENESIS 37:3-36)

MEMORY VERSE:

"Blessed are you when they revile and persecute you, and say all kinds of evil against you falsely for My sake." MATTHEW 5:11

FILL IN THE BLANKS:

1. "Now Israel loved Joseph _____ than all his children, because he was the son of his old age. Also he made him a tunic of many _____" **GENESIS 37:3**
2. "But when his brothers saw that their father _____ him more than all his brothers, they _____ him and could not speak peaceably to him." **GENESIS 37:4**

UNDERLINE THE CORRECT ANSWER:

3. "Now Joseph..." **GENESIS 37:5**
 - a. dreamed a dream
 - b. told it to his brothers
 - c. and they hated him even more
 - d. all of these

TRUE OR FALSE:

4. Joseph had no more dreams and his brothers then began to love him. **GENESIS 37:9**
TRUE OR FALSE

FILL IN THE BLANKS:

5. "Then his brothers went to feed their father's flock in Shechem. And Israel said to Joseph, 'Are not your brothers _____ the flock in Shechem? Come, I will send you to them.' So he said to him, 'Here I am.'" **GENESIS 37:12-13**
6. "Now when they saw him afar off, even before he came near them, they conspired against him to kill him. Then they said to one another, 'Look, this _____ is coming! Come therefore, let us now kill him and cast him into some _____; and we shall say, "Some wild beast has devoured him." We shall see what will become of his dreams!' " **GENESIS 37:18-20**

TRUE OR FALSE:

7. "And Reuben said to them, 'Shed no blood, but cast him into this pit which is in the wilderness, and do not lay a hand on him' - that he might deliver him out of their hands, and bring him back to his father." **GENESIS 37:22**
TRUE OR FALSE

FILL IN THE BLANKS:

8. "Then Midianite traders passed by; so the brothers pulled Joseph up and lifted him out of the pit, and _____ him to the Ishmaelites for twenty shekels of silver. And they took Joseph to _____." **GENESIS 37:28**
9. "Then they sent the tunic of many colors, and they brought it to their father and said, 'We have found this. Do you know whether it is your son's tunic or not? And he recognized it and said, 'It is my son's tunic. A wild beast has devoured him. Without doubt _____ is torn to pieces.'" **GENESIS 37:32-33**
10. "And all his sons and all his daughters arose to comfort him; but he _____ to be comforted, and he said, 'For I shall go down into the grave to my son in mourning.' Thus his father wept for him." **GENESIS 37:35**

28. JOSEPH IS SOLD BY HIS BROTHERS

(GENESIS 37:3-36)

C D Y P X E Z Y X I F T H V O J T S Y G S T G T E M S V U L
 U J D E T A H Y P X P E P A K O M M R F N I R Q S T A R S J
 Q Q N H T P Z O N G G J J R Q U O L G Y C I H C Y C K P V V
 D I M Z Y Z K F E Y K K H L K G E T I Q Z P U D B D T T P U
 C K H I L C C V B P B K Q W L F M U K S M G V Y T N E J I X
 N T L V I C T M U Y U P O J W K X N M D E C Y R I Y F I R E
 W D D V O Q I S E B K Z A U K D N I A C R V Y I S R A E L A
 T Y R B V I O V R D C Y W O I B N C V M P J A Q O J Y P F F
 I L E Q S R E H T O R B V E J K O O X P J N R E W D R K V I
 W H O Y Q W T M J R U Y M P S K B P O O P H T T H V N D Q M
 P U U V Z Z A A H C M O F T U A U C O M Q E E M A S L A X I
 P Q W E E K N Z N G D J S C E T L D U E X D U B A C M Y I O
 W S J L U D M U G R L F W S A W P T V H A D U J E E A S P Q
 P S N N A K S S E G S A U C V I M X Z A Q B S K P U R G O H
 I I S V N Q P H U N V H D H D L S X A Y F Y S I Q A X D R U
 T L Z Q M J I M W G R A S U Q A C H U U G K F J T U T M A N
 Q S S R O L O C Y N A M J E E P C G M H A K J E F T O X V H
 T J K T B B Q X D Z C H H C N P V E E A M J S F V E N T K P
 A F B A G O D S W J M Z Q N R A Z I F A E M G S I K K L R U
 U F Z Q F B W V Y P L Y O Q Y X K K P E M L R A F O V A W Y
 U O F F H R J E P N B N E L Y V F X T C A V I G R O E B Y N
 H P H H A B Q O D U X J W K D Q K P O N O W A T N P F H B M
 E E N P W K R J Z O A T E D J D S P N A K Z S Q E F G P G H
 R O G J X E I J W F C P B D I V M U R E V L I S Y S S U P B
 J S A C K C L O T H W L K J P S O Z I I C F F F M D L V F Y
 S O X T P F L E B L J J S O T M A V J Z Y I N H Z H C L Q A
 T C G B E J S A M L U C U S V C T F J G U Z S W U D Y R K O
 A F R I S T T W W M K V H E R Z M R Y O D T E U I F D R G M
 Z K Q A G E F L U S O T P P F L Z K T A Y M L I K W T E X B
 S B I M D J A Z F Z I W E H E U J K H T G G L K N Y L V Q H

BOWED
 BROTHERS
 DREAM
 GOAT
 HATED
 ISHMAELITES

ISRAEL
 JOSEPH
 JUDAH
 LOVED
 MANY COLORS

MOON
 PIT
 REUBEN
 SACKCLOTH
 SELL

SHEAVES
 SILVER
 STARS
 SUN
 TUNIC



REMOVE JOSEPH FROM THE PIT
 AND HELP HIM GET TO EGYPT

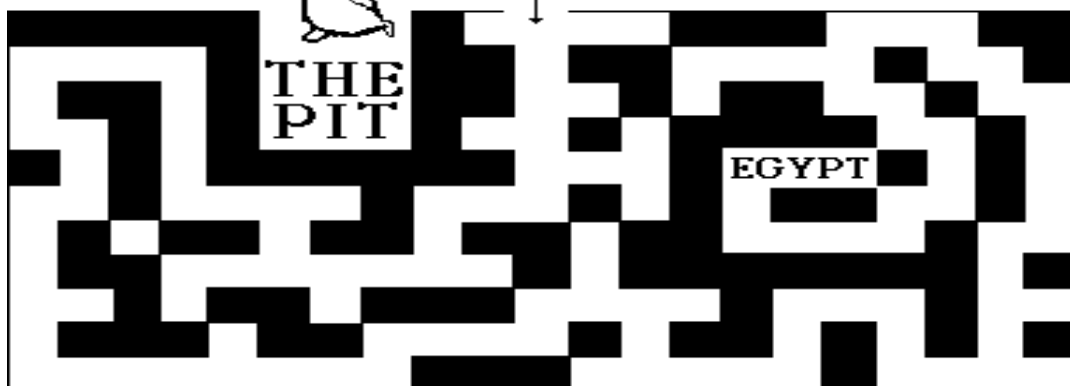

28. JOSEPH IS SOLD BY HIS BROTHERS (GENESIS 37:3-36)

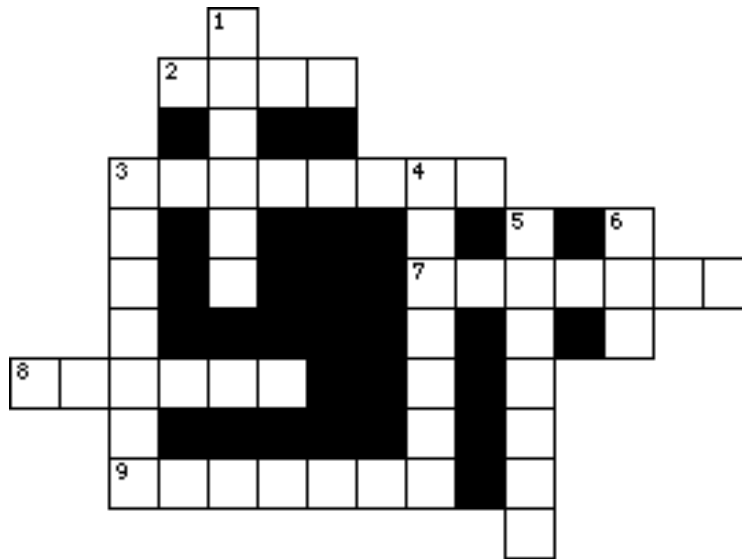

- 3 DOWN "_____ are you when they revile and persecute you, and say all kinds of evil against you falsely for My sake." **MATTHEW 5:11**
- 1 DOWN "Now Israel loved Joseph more than all his children, because he was the son of his old age. Also he made him a tunic of many _____." **GENESIS 37:3**
- 3 ACROSS "But when his _____ saw that their father loved him more than all his brothers, they hated him and could not speak peaceably to him." **GENESIS 37:4**
- 9 ACROSS "Now Joseph _____ a dream, and he told it to his brothers; and they hated him even more." **GENESIS 37:5**
- 7 ACROSS "Then his brothers went to feed their father's flock in Shechem. And Israel said to Joseph, 'Are not your brothers _____ the flock in Shechem? Come, I will send you to them.' So he said to him, 'Here I am.' " **GENESIS 37:12-13**
- 6 DOWN "Now when they saw him afar off, even before he came near them, they conspired against him to kill him. Then they said to one another, 'Look, this dreamer is coming! Come therefore, let us now kill him and cast him into some _____; and we shall say, "Some wild beast has devoured him." We shall see what will become of his dreams!' " **GENESIS 37:18-20**
- 5 DOWN "And Reuben said to them, 'Shed no blood, but cast him into this pit which is in the wilderness, and do not lay a hand on him' - that he might _____ him out of their hands, and bring him back to his father." **GENESIS 37:22**
- 2 ACROSS "Then Midianite traders passed by; so the brothers pulled Joseph up and lifted him out of the pit, and _____ him to the Ishmaelites for twenty shekels of silver. And they took Joseph to Egypt." **GENESIS 37:28**
- 8 ACROSS "Then they sent the tunic of many colors, and they brought it to their father and said, 'We have found this. Do you know whether it is your son's tunic or not? And he recognized it and said, 'It is my son's tunic. A wild beast has devoured him. Without doubt _____ is torn to pieces.'" **GENESIS 37:32-33**
- 4 DOWN "And all his sons and all his daughters arose to comfort him; but he _____ to be comforted, and he said, 'For I shall go down into the grave to my son in mourning.' Thus his father wept for him." **GENESIS 37:35**

Bible Story 29

JOSEPH AND POTIPHAR

GENESIS 39:1-23

29. JOSEPH & POTIPHAR

(GENESIS 39:1-23)



"And it came to pass, when his master heard the words of his wife, which she spake unto him, saying, After this manner did thy servant to me; that his wrath was kindled."

GENESIS 39:19

29. JOSEPH & POTIPHAR (GENESIS 39:1-23)

MEMORY VERSE:

"Blessed are those who are persecuted for righteousness' sake, for theirs is the kingdom of heaven." MATTHEW 5:10

CIRCLE THE CORRECT WORD:

1. "Now Joseph had been taken down to (**GREECE, EGYPT**). And Potiphar, an officer of Pharaoh, captain of the guard, an Egyptian, bought him from the Ishmaelites who had taken him down there." **GENESIS 39:1**

TRUE OR FALSE:

2. "And his master saw that the LORD was with him and that the LORD made all he did to prosper in his hand." **GENESIS 39:3**

TRUE OR FALSE

3. "So Joseph found favor in his sight, and served him. Then he made him overseer of his house, and all that he had he put in his hand." **GENESIS 39:4**

TRUE OR FALSE

FILL IN THE BLANKS:

4. "So it was, from the time that he had made him overseer of his house and _____ that he had, that the LORD blessed the Egyptian's house for Joseph's sake; and the blessing of the LORD was on _____ that he had in the house and in the field." **GENESIS 39:5**

CIRCLE THE CORRECT WORDS:

5. Then Potiphar's anger was aroused against Joseph, and his "master took him and put him into the (**PALACE, PRISON**), a place where the king's prisoners were confined. And he was there in (**PALACE, PRISON**)." **GENESIS 39:20**

TRUE OR FALSE:

6. "But the LORD was with Joseph and showed him mercy, and He gave him favor in the sight of the keeper of the prison." **GENESIS 39:21**

TRUE OR FALSE

7. But the keeper of the prison did not trust Joseph, neither would he commit any duties to him. **GENESIS 39:22**

TRUE OR FALSE

8. "The keeper of the prison did not look into anything that was under Joseph's hand, because the LORD was with him; and whatever he did, the LORD made it prosper." **GENESIS 39:23**

TRUE OR FALSE

29. JOSEPH & POTIPHAR

(GENESIS 39:1-23)

B I T T A T K I B S A S I N E
Z U D A R T O V E R S E E R M
Z N D W Y A B E P S F J D K Q
N A I A I R H J O S E P H K N
K F Q A Q C C P P I U K V R Y
O F C U T R K P I D R O L E M
B T Y E U P D E Y T T G B N A
H Q U C G W A E D N O H G C S
F P J E R Y D C S N O P C V V
V H R N Q E P I F S E S Z C Y
I A K O A P M T O F E S I C K
O U S Q S N W Y W A A L S R W
N U M X T P G B J I O V B H P
K E E P E R E E W G F G O R L
H T J N H N K R L W M E H R W

ANGEL
BLESSED
CAPTAIN
EGYPT
FAVOR
JOSEPH

KEEPER
LORD
MERCY
OVERSEER
POTIPHAR

PRISON
PROSPER
SIN
WICKEDNESS
WIFE

29. JOSEPH & POTIPHAR (GENESIS 39:1-23)

MEMORY VERSE:

"Blessed are those who are persecuted for righteousness' sake, for theirs is the kingdom of heaven." MATTHEW 5:10

FILL IN THE BLANKS:

1. "Now _____ had been taken down to _____. And _____, an officer of Pharaoh, captain of the guard, an Egyptian, bought him from the Ishmaelites who had taken him down there." **GENESIS 39:1**

TRUE OR FALSE:

2. "And his master saw that the LORD was with him and that the LORD made all he did to prosper in his hand." **GENESIS 39:3**

TRUE OR FALSE

3. "So Joseph found favor in his sight, and served him. Then he made him overseer of his house, and all that he had he put in his hand." **GENESIS 39:4**

TRUE OR FALSE

FILL IN THE BLANKS:

4. "So it was, from the time that he had made him overseer of his house and _____ that he had, that the LORD blessed the Egyptian's house for Joseph's sake; and the blessing of the LORD was on _____ that he had in the house and in the field." **GENESIS 39:5**

5. Then Potiphar's anger was aroused against Joseph, and his "master took him and put him into the _____, a place where the king's prisoners were confined. And he was there in _____." **GENESIS 39:20**

6. "But the LORD was with Joseph and showed him _____, and He gave him _____ in the sight of the keeper of the prison." **GENESIS 39:21**

TRUE OR FALSE:

7. But the keeper of the prison did not trust Joseph, neither would he commit any duties to him. **GENESIS 39:22**

TRUE OR FALSE

8. "The keeper of the prison did not look into anything that was under Joseph's hand, because the LORD was with him; and whatever he did, the LORD made it prosper." **GENESIS 39:23**

TRUE OR FALSE

29. JOSEPH & POTIPHAR

(GENESIS 39:1-23)

P C S J E H T A W I V G G C J P D J Q I W M S P A
M D R O L Z N N Z O L E R L K L S U N P F A V O R
N U T F U I O M K T S U G M K C J O L T L O M P U
R Q A F W V S G N A V W N D W R A E W V A E O U E
X D Z O J V I F Q N M D G L I J E P K R P M A Z F
D C S P N B R H J R A W Z S F C H P T K E E P E R
C A D E S Q P A B P Z Y J N E V Q P S A P X T V P
U N N D E S S E L B S P P V I T O T I O I N M F T
G W J G Z Y B W B I H Z N R P S E C J Y R N Z R O
D T Q O E E I X R Q M W U C Z W W S S F C P J K N
T I I O L L A P B D L B O M Y H T P Y G E R S K I
A W J C B L M E K J S M W L Y P E C U E A O E Y J
S P T F Z N N S E Q V W F I O J B H E J X B M M J
T P D G F V T G F R O U L B C H K U A O V U X R Y
O W R E E S R E V O J F L M J K S E V U Q L P G T
T Q Y B H Q Y D J I J I M A F Q E C D G D P C I H
W T H Y N T L E J L E N S C A O U D Q F V M D N G
F A U N G A I O T S A G Z W H A H N N K S C T L F
A U Q M X Q S P E T W Y F J A W P Q E E M C N A Y
M U S H G E O Z J F L P P U H V E L N D S V X V Q
P O T I P H A R Z A Z Y G K Z M V K R B C S G M D
F H S H R F V C Z Y X B K O Y F A D Y K Z Z E O C
H E I L Q H Q C K Y P D B I N S R D Y K L H I U M
K R L D I P Z Q C O J R H T J W L O D A B F L V P
N J S R P J U I T M H C K E T U W K J T T M N Z O

ANGEL
BLESSED
CAPTAIN
EGYPT
FAVOR
JOSEPH

KEEPER
LORD
MERCY
OVERSEER
POTIPHAR

PRISON
PROSPER
SIN
WICKEDNESS
WIFE

29. JOSEPH & POTIPHAR (GENESIS 39:1-23)

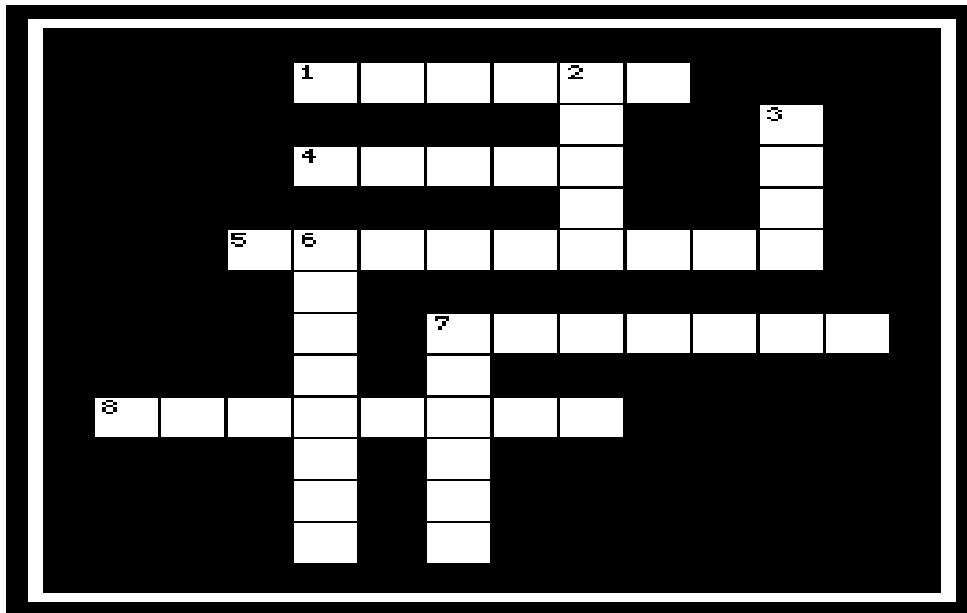

- 1 ACROSS "Blessed are those who are persecuted for righteousness' sake, for theirs is the kingdom of _____. "**MATTHEW 5:10**
- 2 DOWN "Now Joseph had been taken down to _____. And Potiphar, an officer of Pharaoh, captain of the guard, an Egyptian, bought him from the Ishmaelites who had taken him down there." **GENESIS 39:1**
- 3 DOWN "And his master saw that the _____ was with him and that the LORD made all he did to prosper in his hand." **GENESIS 39:3**
- 6 DOWN "So Joseph found favor in his sight, and served him. Then he made him _____ of his house, and all that he had he put in his hand." **GENESIS 39:4**
- 8 ACROSS "So it was, from the time that he had made him overseer of his house and all that he had, that the LORD blessed the Egyptian's house for Joseph's sake; and the _____ of the LORD was on all that he had in the house and in the field." **GENESIS 39:5**
- 7 DOWN Then Potiphar's anger was aroused against Joseph, and his "master took him and put him into the _____, a place where the king's prisoners were confined. And he was there in prison."
GENESIS 39:20
- 4 ACROSS "But the LORD was with Joseph and showed him _____, and He gave him favor in the sight of the keeper of the prison." **GENESIS 39:21**
- 5 ACROSS "And the keeper of the prison _____ to Joseph's hand all the prisoners who were in prison."
GENESIS 39:22
- 7 ACROSS "The keeper of the prison did not look into anything that was under Joseph's hand, because the LORD was with him; and whatever he did, the LORD made it _____." **GENESIS 39:23**

Bible Story 30

JOSEPH IN PRISON

GENESIS 40:1-41:57

30. JOSEPH IN PRISON

(GENESIS 40:1-41:57)



"And Joseph's master took him, and put him into the prison, a place where the king's prisoners *were* bound: and he was there in the prison."

GENESIS 39:20

30. JOSEPH IN PRISON

(GENESIS 40:1-41:57)

MEMORY VERSE:

"Blessed are the pure in heart, for they shall see God." MATTHEW 5:8

FILL IN THE BLANKS:

1. "And it came to pass after these things that the _____ and the _____ of the king of Egypt offended their lord, the king of Egypt." **GENESIS 40:1**

TRUE OR FALSE:

2. "So he put them in custody in the house of the captain of the guard, in the prison, the place where Joseph was confined." **GENESIS 40:3**

TRUE OR FALSE

3. "Then the butler and the baker of the king of Egypt, who were confined in the prison, dreamed a dream, both of them." **GENESIS 40:5**

TRUE OR FALSE

UNDERLINE THE CORRECT ANSWER:

4. "And they said to him, 'We each have dreamed a dream, and there is no interpreter of it.' And Joseph said to them..." **GENESIS 40:8**
- a. Do not interpretations belong to God?
 - b. Tell them to me, please.
 - c. both of these

TRUE OR FALSE:

5. The Pharaoh "restored the chief butler to his butlership again, and he placed the cup in Pharaoh's hand. But he hanged the chief baker, as Joseph had interpreted to them." **GENESIS 40:21-22**

TRUE OR FALSE

CIRCLE THE CORRECT WORDS:

6. "Yet the chief butler did not remember Joseph, but (**FORGOT**, **FORGAVE**) him." **GENESIS 40:23**
7. "Then it came to pass, at the end of two full (**DAYS**, **YEARS**), that Pharaoh had a dream." **GENESIS 41:1**
8. "Now it came to pass in the morning that his spirit was troubled, and he sent and called for all the magicians of Egypt and all its wise men. And Pharaoh told them his (**SECRETS**, **DREAMS**), but there was no one who could interpret them for Pharaoh." **GENESIS 41:8**
9. "Then Pharaoh sent and called Joseph, and they brought him hastily out of the (**DUNGEON**, **PALACE**); and he shaved, changed his clothing, and came to Pharaoh." **GENESIS 41:14**
10. After Joseph interpreted Pharaoh's dreams, Pharaoh "said to his servants, 'Can we find such a one as this, a man in whom is the Spirit of God?' Then Pharaoh said to Joseph, 'Inasmuch as (**GOD**, **MAN**) has shown you all this, there is no one as discerning and wise as you. You shall be over my house, and all my people shall be ruled according to your word; only in regard to the (**CROWN**, **THRONE**) will I be greater than you.' " **GENESIS 41:38-40**

30. JOSEPH IN PRISON

(GENESIS 40:1-41:57)

T O G R O F B U T L E R Z S E
 N H K I N G R D D Q L F V D N
 B P L T W V E S W O C F Q T I
 U E T W S N M Y Y P G Z P I M
 R S G D E O E N T S U Y N E A
 E O H R S E M K N M G T Q B F
 K J Q E U G B P E E E D S B E
 A P C A O N E H L R O R S U O
 B R A M H U R Q P O O F E Q N
 Q I P V E D U R F U N M N J R
 D S T G R Z E O F D T C D A L
 Y O A N O T W Z L Z L R N D X
 C N I I T P H A R A O H I I D
 Z S N R S Q D A S O R I K O V
 Y V Z L M B G R A I N P N B Z

- | | | | |
|---------|--------|-----------|-------------|
| BAKER | EGYPT | INTERPRET | PRISON |
| BUTLER | FAMINE | JOSEPH | REMEMBER |
| CAPTAIN | FOOD | KINDNESS | RING |
| COWS | FORGOT | KING | SAD |
| DREAM | GOD | PHARAOH | STOREHOUSES |
| DUNGEON | GRAIN | PLENTY | |

HELP JOSEPH GET TO THE THRONE OF PHARAOH

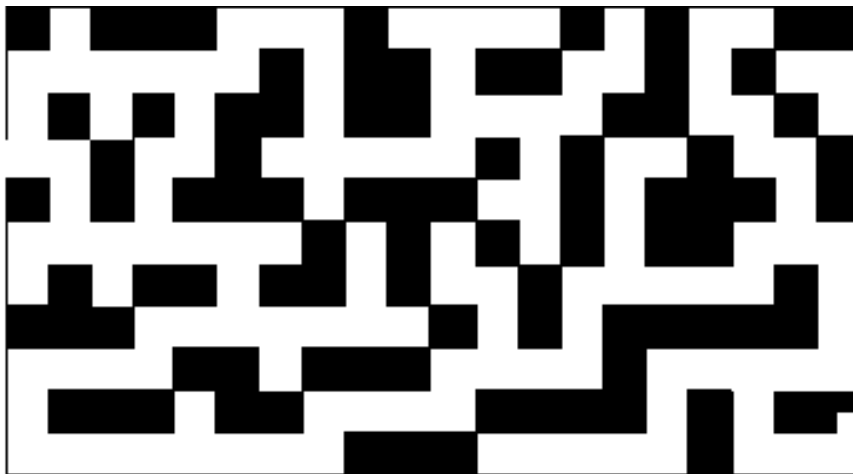

30. JOSEPH IN PRISON

(GENESIS 40:1-41:57)

MEMORY VERSE:

"Blessed are the pure in heart, for they shall see God." MATTHEW 5:8

FILL IN THE BLANKS:

1. "And it came to pass after these things that the _____ and the _____ of the king of Egypt offended their lord, the king of Egypt." **GENESIS 40:1**
2. "So he put them in custody in the house of the captain of the guard, in the prison, the place where _____ was confined." **GENESIS 40:3**
3. "Then the butler and the baker of the king of Egypt, who were confined in the prison, dreamed a _____, both of them." **GENESIS 40:5**

UNDERLINE THE CORRECT ANSWER:

4. "And they said to him, 'We each have dreamed a dream, and there is no interpreter of it.' And Joseph said to them..." **GENESIS 40:8**
 - a. Do not interpretations belong to God?
 - b. Tell them to me, please.
 - c. both of these

TRUE OR FALSE:

5. The Pharaoh "restored the chief butler to his butlership again, and he placed the cup in Pharaoh's hand. But he hanged the chief baker, as Joseph had interpreted to them." **GENESIS 40:21-22**
TRUE OR FALSE

FILL IN THE BLANKS:

6. "Yet the chief butler did not remember Joseph, but _____ him." **GENESIS 40:23**
7. "Then it came to pass, at the end of two full _____, that Pharaoh had a dream." **GENESIS 41:1**
8. "Now it came to pass in the morning that his spirit was troubled, and he sent and called for all the magicians of Egypt and all its wise men. And Pharaoh told them his _____, but there was no one who could interpret them for Pharaoh." **GENESIS 41:8**
9. "Then Pharaoh sent and called Joseph, and they brought him hastily out of the _____; and he shaved, changed his clothing, and came to Pharaoh." **GENESIS 41:14**

CIRCLE THE CORRECT WORDS:

10. After Joseph interpreted Pharaoh's dreams, Pharaoh "said to his servants, 'Can we find such a one as this, a man in whom is the Spirit of God?' Then Pharaoh said to Joseph, 'Inasmuch as **(GOD, MAN)** has shown you all this, there is no one as discerning and wise as you. You shall be over my house, and all my people shall be ruled according to your word; only in regard to the **(CROWN, THRONE)** will I be greater than you.'" **GENESIS 41:38-40**

30. JOSEPH IN PRISON

(GENESIS 40:1-41:57)

D M I Y C K Y Z B Z L J E K V Z Z I H R G U T P C R I P Q Y
 Y H M A E R D X D F O C B D R L J N G P C V B Q P R I S O N
 H L V G C C O P N P I V K D F U S L F J J Y K T U N P I L A
 U D N L Q T F J O G T T S O E T M B Y P N Y I F A L K R J O
 Q I V I I I V H E K E W U K J M X A Q N H R J V U M D F V M
 R R B O W O L G G B J H H Q O O P K D Q I T E I T A A V U B
 S E Q V Z T S E N U K P P K U E C E C P E A F F A M I N E H
 S U Y Q K A V U U K K J E L G M T R M Q D E T F E X Y Q L N
 I B E Z S S E N D N I K V W F X D P P F B U S P K T S L E L
 L W U U K N M W R C P H A K K N T A Y G Y S A R A O G I A V
 S J L T S R A D C U Z Q R I D O M V O G K S G H O C M P F I
 J N N A L A Z W G M Y O L J B B M L E A E F Q N P N S O I U
 F S V N Q E D Y R G Y A W S K U G O A T O G R O F E T R M S
 G Z Q M J P R P G D O W J U K S E U Y M K J F Y O L S A I S
 R K T G B I S Z N L O D U E A L T V U M J S H M P V L O O A
 A B A F B Q H W G S J V O A T P I O H A M G W Z F E A V J L
 I Z T E R P R E T N I M E V W M K Z R O V R U U D F B K Q Y
 N F Q H P D M B Z V F F P D L C X A A E W A I I H G H R H J
 F H F A R L X M J R A S T Q A C P U E K H S K K D S P W U H
 O N H W B J E W P C H W C E P V P E C C Z O E N F L F Y N W
 P G P V K Q S N N M A U S N P Z U F N Y F F U M W C U O H Z
 E F J P E R V U T L S D C R A N Z P A U I N Y S Y Y V B O A
 O G T E F I O F U Y H W H Y N F V T I D Z T B C E D L G P D
 O R B S J L J I O B Z S O Y V N F O H O A R A H P S G N I K
 C R E M E M B E R N Y J U C Q S R N Z Y T Q T D S T R P U P
 F Q I G T S J N F A N H E D D M K I S G M C I N K L R F Y N
 K I A D E T E G L C J Q C J V O K J N T G D O Y T V E Q N I
 B P M E J F A N L W T O N I S A Y J C I G Y W J E P V K M C
 Y H N P Z A W P M J P E Q P M T R Y Z I R R A D F T U G H N
 N Z T Z Z Y L Y S U L W L T C M G T X P H Q E V Y J V N B Z

BAKER
 BUTLER
 CAPTAIN
 COWS
 DREAM
 DUNGEON

EGYPT
 FAMINE
 FOOD
 FORGOT
 GOD
 GRAIN

INTERPRET
 JOSEPH
 KING
 KINDNESS
 PHARAOH
 PLENTY

PRISON
 REMEMBER
 RING
 SAD
 STOREHOUSES

HELP JOSEPH GET TO THE THRONE OF PHARAOH

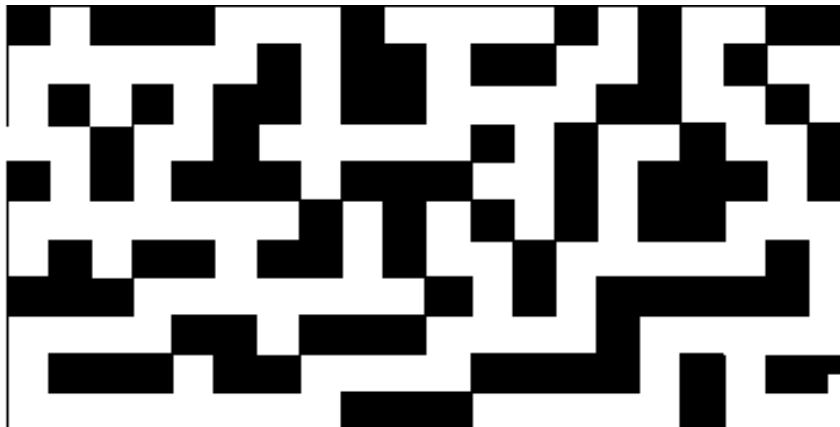

30. JOSEPH IN PRISON (GENESIS 40:1-41:57)

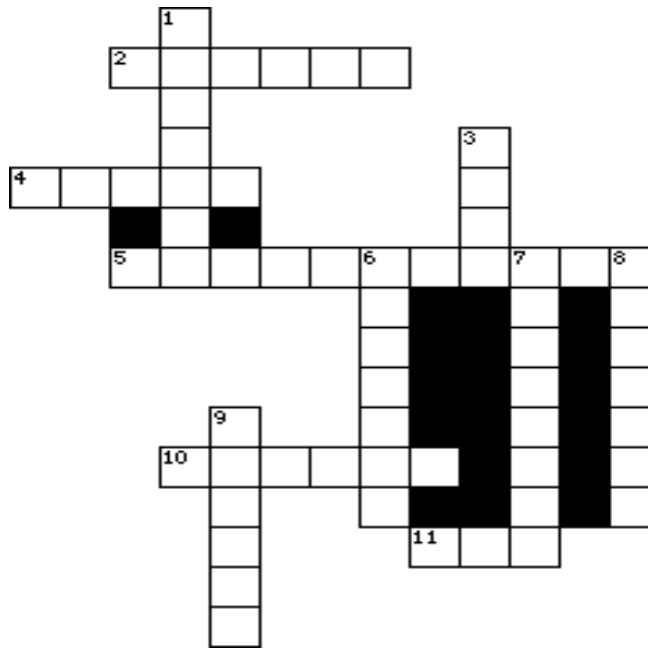

- 3 DOWN "Blessed are the _____ in heart, for they shall see God." **MATTHEW 5:8**
- 2 ACROSS "And it came to pass after these things that the _____ and the baker of the king of Egypt offended their lord, the king of Egypt." **GENESIS 40:1**
- 9 DOWN "So he put them in custody in the house of the captain of the guard, in the prison, the place where _____ was confined." **GENESIS 40:3**
- 4 ACROSS "Then the butler and the _____ of the king of Egypt, who were confined in the prison, dreamed a dream, both of them." **GENESIS 40:5**
- 8 DOWN "And they said to him, 'We each have _____ a dream, and there is no interpreter of it.' And Joseph said to them, 'Do not interpretations belong to God? Tell them to me, please.'" **GENESIS 40:8**
- 5 ACROSS The Pharaoh "restored the chief butler to his butlership again, and he placed the cup in Pharaoh's hand. But he hanged the chief baker, as Joseph had _____ to them." **GENESIS 40:21-22**
- 10 ACROSS "Yet the chief butler did not remember Joseph, but _____ him." **GENESIS 40:23**
- 6 DOWN "Then it came to pass, at the end of two full years that _____ had a dream." **GENESIS 41:1**
- 7 DOWN "Now it came to pass in the morning that his spirit was _____ and he sent and called for all the magicians of Egypt and all its wise men. And Pharaoh told them his dreams but there was no one who could interpret them for Pharaoh." **GENESIS 41:8**
- 1 DOWN "Then Pharaoh sent and called Joseph, and they brought him hastily out of the _____ ; and he shaved, changed his clothing, and came to Pharaoh." **GENESIS 41:14**
- 11 ACROSS After Joseph interpreted Pharaoh's dreams, Pharaoh "said to his servants, 'Can we find such a one as this, a man in whom is the Spirit of God?' Then Pharaoh said to Joseph, 'Inasmuch as _____ has shown you all this, there is no one as discerning and wise as you. " **GENESIS 41:38-39**

Bible Story 31

JOSEPH TESTS HIS BROTHERS

GENESIS 42:1-44:34

31. JOSEPH TESTS HIS BROTHERS

(GENESIS 42:1-44:34)



"And he searched, *and* began at the eldest, and left at the youngest:
and the cup was found in Benjamin's sack."

GENESIS 44:12

31. JOSEPH TESTS HIS BROTHERS

(GENESIS 42:1-44:34)

MEMORY VERSE:

"For nothing is secret that will not be revealed, nor anything hidden that will not be known and come to light." LUKE 8:17

CIRCLE THE CORRECT WORDS:

1. "Joseph's ten brothers went down to buy (**HORSES, GRAIN**) in Egypt. But Jacob did not send Joseph's brother (**BENJAMIN, ISAIAH**) with his brothers, for he said, 'Lest some calamity befall him.'" **GENESIS 42:3-4**
2. "Now Joseph was governor over the land; and it was he who (**SOLD, TALKED**) to all the people of the land. And Joseph's brothers came and bowed down before him with their faces to the (**EARTH, SKY**)." **GENESIS 42:6**

TRUE OR FALSE:

3. So Joseph recognized his brothers, and they recognized Joseph too. **GENESIS 42:8**
TRUE OR FALSE

FILL IN THE BLANKS:

4. Joseph said, "You are _____! In this manner you shall be _____: By the life of Pharaoh, you shall not leave this place unless your youngest brother comes here. Send one of you, and let him bring your brother; and you shall be kept in _____, that your words might be tested to see whether there is any truth in you; or else, by the life of Pharaoh, surely you are spies!" **GENESIS 42:14-16**

CIRCLE THE CORRECT WORDS:

5. "Then Joseph gave a command to fill their sacks with (**MUD, GRAIN**), to restore every man's money to his sack, and to give them provisions for the journey." **GENESIS 42:25**
6. "And it came to pass, when they had eaten up the grain which they had brought from (**JERUSALEM, EGYPT**), that their father said to them, 'Go back, buy us a little food.'" **GENESIS 43:2**

TRUE OR FALSE:

7. "So the men took that present and Benjamin, and they took double money in their hand, and arose and went down to Egypt; and they stood before Joseph." **GENESIS 43:15**
TRUE OR FALSE

CIRCLE THE CORRECT WORDS:

8. "Now the men were (**EXCITED, AFRAID**) because they were brought into Joseph's house; and they said, 'It is because of the money, which was returned in our sacks the first time, that we are brought in, so that he may seek an occasion against us and fall upon us, to take us as (**SLAVES, PRINCES**) with our donkeys.'" **GENESIS 43:18**
9. As the brothers were heading home, Joseph commanded, 'Put my cup, the (**SILVER, GOLD**) cup, in the mouth of the sack of the youngest, and his grain money.'" **GENESIS 44:2**
10. Now the cup was found in the sack of Benjamin, and as the brothers again stood before Joseph, "Judah said, 'What shall we say to my lord? What shall we speak? Or how shall we clear ourselves? (**GOD, PHARAOH**) has found out the iniquity of your servants; here we are, my lord's slaves, both we and he also with whom the cup was found.'" **GENESIS 44:16**

31. JOSEPH TESTS HIS BROTHERS

(GENESIS 42:1-44:34)

D K V P U C R E V L I S E T P E W T Z K
A G E E B S H W T E Q B U U D X Y Q Z I
M C Y O J K R Z B N N P R E Y D L T E Z
D B W Z O Z Y E H C U I T L C M C I T U
I E B H M M J F H L R S M M Z M O B Q W
D B G R F J A O G T E F B A A M Y A H A
R V R O S A L J A T O A M O F X Y C D T
G K A N P P C L G C B R B E N J A M I N
K G I R I N Q N O C L B B T J O C D D C
F V N E E E Y A D T Y E K J P R Y N S O
Q E P V S P V Y A L F G N B T R D V F B
N A B O O N F O L W B G X H L P I B N U
I B N G N U D P M S O H H Z T H Y S V M
S Y E K N O D M I I W S O R R O W G O P
R Y Y F V U Q E G M M B A J A P W C E N
C A N A A N D A H E C M E R C Y S V W A
J Z Q M E K I Q T O W Y G L E N A C T J
B O C A J C D T Y N A X K L H P E S O J
L R Q C H A B S K R V A Y E N O M A J Y
D Q F G C S V C E S W P S B L T B W R K

BENJAMIN

FAMINE

MERCY

SIMEON

BOWED

GOD ALMIGHTY

MONEY

SORROW

BROTHERS

GOVERNOR

PRISON

SPIES

CANAAN

GRAIN

SACK

TESTED

DONKEYS

JACOB

SILVER CUP

WEPT

EGYPT

JOSEPH

31. JOSEPH TESTS HIS BROTHERS

(GENESIS 42:1-44:34)

MEMORY VERSE:

"For nothing is secret that will not be revealed, nor anything hidden that will not be known and come to light." LUKE 8:17

FILL IN THE BLANKS:

1. "Joseph's ten brothers went down to buy _____ in Egypt. But Jacob did not send Joseph's brother _____ with his brothers, for he said, 'Lest some calamity befall him.'" **GENESIS 42:3-4**
2. "Now Joseph was governor over the land; and it was he who _____ to all the people of the land. And Joseph's brothers came and _____ down before him with their faces to the earth." **GENESIS 42:6**

TRUE OR FALSE:

3. So Joseph recognized his brothers, and they recognized Joseph too. **GENESIS 42:8**
TRUE OR FALSE

FILL IN THE BLANKS:

4. Joseph said, "You are _____! In this manner you shall be _____: By the life of Pharaoh, you shall not leave this place unless your youngest brother comes here. Send one of you, and let him bring your brother; and you shall be kept in prison that your words might be tested to see whether there is any truth in you; or else, by the life of Pharaoh, surely you are spies!" **GENESIS 42:14-16**
5. "Then Joseph gave a _____ to fill their sacks with grain, to restore every man's money to his sack, and to give them provisions for the journey." **GENESIS 42:25**

CIRCLE THE CORRECT WORD:

6. "And it came to pass, when they had eaten up the grain which they had brought from (JERUSALEM, EGYPT), that their father said to them, 'Go back, buy us a little food.'" **GENESIS 43:2**

TRUE OR FALSE:

7. "So the men took that present and Benjamin, and they took double money in their hand, and arose and went down to Egypt; and they stood before Joseph." **GENESIS 43:15**
TRUE OR FALSE

FILL IN THE BLANKS:

8. "Now the men were _____ because they were brought into Joseph's house; and they said, 'It is because of the money, which was returned in our sacks the first time, that we are brought in, so that he may seek an occasion against us and fall upon us, to take us as _____ with our donkeys.'" **GENESIS 43:18**
9. As the brothers were heading home, Joseph commanded, 'Put my cup, the _____ cup, in the mouth of the sack of the youngest, and his grain money.'" **GENESIS 44:2**

CIRCLE THE CORRECT WORD:

10. Now the cup was found in the sack of Benjamin, and as the brothers again stood before Joseph, "Judah said, 'What shall we say to my lord? What shall we speak? Or how shall we clear ourselves? (GOD, PHARAOH) has found out the iniquity of your servants; here we are, my lord's slaves, both we and he also with whom the cup was found.'" **GENESIS 44:16**

31. JOSEPH TESTS HIS BROTHERS

(GENESIS 42:1-44:34)

O V M T V S P A H W F A B F J U Z Z L T A A G P S A H X L T
 J J F N I M N G K W B D P O B G S S R C Q L A L L K C I J I
 Q X M D O J K W K Z E Y S E J C I A U M A U K Y P R O V V L
 S W Q R B T B A R H S S O G O V E R N O R E R M H V V M R E
 P E S O N A G F E O P M T P H V F M U P O D B T L Z N T R I
 M L C H H A C O R O H E W K T U A Z C M Y K N F Q Y J Q K A
 B A Q A A U D R D A T U S J J B M B Q L N I A R G E L V J K
 J V V Z I D O U N A L X I O Y N I T N C E L Y H D E W O B Q
 B D P E U W U T C K L S H F J H N P R S A S Y E K N O D S Y
 O D B M A E W J V U U M J Y R L E Z U G E C N D U H D U F R
 H Z Q D F N K O C N W E I T D A Z F N E B M M R I Z R G Q P
 S Z J W F Q I M C U Q J D G C N F V B Y E N Q S C C Z B V T
 S O W E P T E J H D N M U W H V Z F I U N Q N R C S N D X P
 R W I Q T E G Y P T I G O U G T P H F W J A P E M G L O R K
 V H C X Q X P Y R L S O L G S A N N W I A R L H R I A N B Z
 N Q T I H N I C E U V V O H Q E D E L N M U J T X F E Z I O
 G I T T A A Y R S F U S U N U I K E A A I M D O G L M F U V
 D L C E U Y B E M I U P I V M S X C J C N E D R B B X N Q L
 P H J A S Q B M Q L L T I S J G U M B L Q S R B I K Z X H C
 K T W L U T P K N Y A V B U Q J Y J B P U Z M S V M U A C Y
 S Y Y B T U E G Y H D W E N O S I R P N T P J M S I I D C Y
 P O J Z T Q P D M X D B R R L P E Q K O V J L C M U J P N P
 P A T Z D T Y H A O W H W X C Z E V J E S H P U K X L U U D
 R V N N D H F G S I T J G H J U J S M M E D O R I W M K K D
 X C A K Q T O D K R L Y T U T F P E U I T C L S R V P I S A
 O A S O C T J V V C A K K Q W I A V M S K U T J K K V V U W
 S L L B U R W B Y F A P W T E B V V M A N U P L Q G E R N Z
 L M O N E Y S G K H O S I S K L K L Y I B S N P Y P C Q E C
 K O P H J R S C W L A G U P M K U A R E Y Y R B C H H I S P
 W Z N F H W I Z L D P K M L L M O I T Y Z J A N Z K M J X Y

BENJAMIN	FAMINE	JUDAH	SIMEON
BOWED	GOD ALMIGHTY	MERCY	SORROW
BROTHERS	GOVERNOR	MONEY	SPIES
CANAAN	GRAIN	PRISON	TESTED
DONKEYS	JACOB	SACK	WEPT
EGYPT	JOSEPH	SILVER CUP	

31. JOSEPH TESTS HIS BROTHERS

(GENESIS 42:1-44:34)

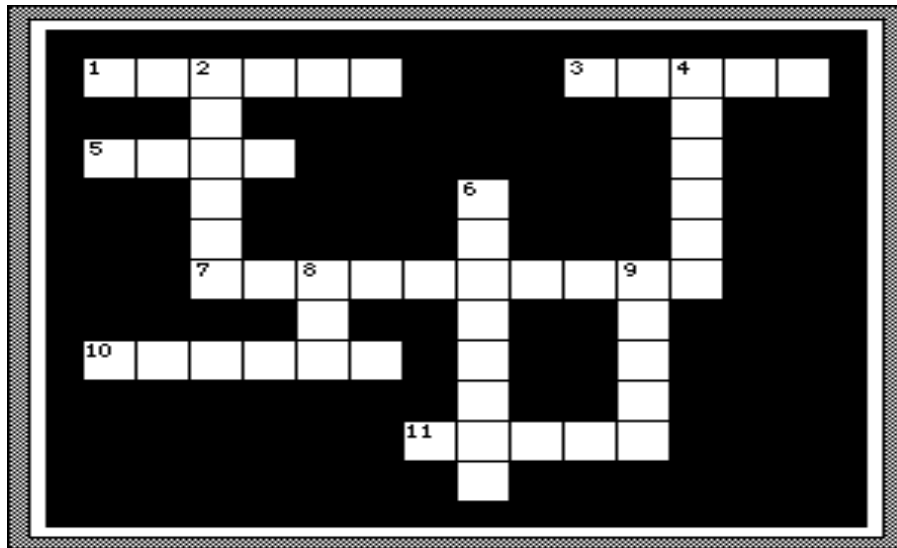

- 11 ACROSS "For nothing is secret that will not be revealed, nor anything hidden that will not be known and come to _____. " **LUKE 8:17**
- 6 DOWN "Joseph's ten brothers went down to buy grain in Egypt. But Jacob did not send Joseph's brother _____ with his brothers, for he said, 'Lest some calamity befall him.' " **GENESIS 42:3-4**
- 5 ACROSS "Now Joseph was governor over the land; and it was he who _____ to all the people of the land. And Joseph's brothers came and bowed down before him with their faces to the earth." **GENESIS 42:6**
- 7 ACROSS "So Joseph _____ his brothers, but they did not recognize him." **GENESIS 42:8**
- 1 ACROSS Joseph said, "You are spies! In this manner you shall be _____: By the life of Pharaoh, you shall not leave this place unless your youngest brother comes here. " **GENESIS 42:14-15**
- 3 ACROSS "Then Joseph gave a command to fill their sacks with _____ to restore every man's money to his sack, and to give them provisions for the journey." **GENESIS 42:25**
- 9 DOWN "And it came to pass, when they had eaten up the grain which they had brought from _____ that their father said to them, 'Go back, buy us a little food.'" **GENESIS 43:2**
- 10 ACROSS "So the men took that present and Benjamin, and they took double money in their hand, and arose and went down to Egypt; and they stood before _____." **GENESIS 43:15**
- 4 DOWN "Now the men were _____ because they were brought into Joseph's house; and they said, 'It is because of the money, which was returned in our sacks the first time, that we are brought in, so that he may seek an occasion against us and fall upon us, to take us as slaves with our donkeys.'" **GENESIS 43:18**
- 2 DOWN As the brothers were heading home, Joseph commanded, 'Put my cup, the _____ cup, in the mouth of the sack of the youngest, and his grain money.' " **GENESIS 44:2**
- 8 DOWN Now the cup was found in the sack of Benjamin, and as the brothers again stood before Joseph, "Judah said, 'What shall we say to my lord? What shall we speak? Or how shall we clear ourselves? God has found out the iniquity of your servants; here we are, my lord's slaves, both we and he also with whom the _____ was found.'" **GENESIS 44:16**

Bible Story 32

**JOSEPH
REVEALS HIMSELF
TO HIS BROTHERS**

GENESIS 45:1-16

32. JOSEPH REVEALS HIMSELF TO HIS BROTHERS (GENESIS 45:1-16)



"And Joseph said unto his brethren, I *am* Joseph; doth my father yet live?
And his brethren could not answer him; for they were troubled at his presence."

GENESIS 45:3

32. JOSEPH REVEALS HIMSELF TO HIS BROTHERS (GENESIS 45:1-16)

MEMORY VERSE:

"Therefore be merciful, just as your Father also is merciful." LUKE 6:36

TRUE OR FALSE:

1. "Then Joseph could not restrain himself before all those who stood by him, and he cried out, 'Make everyone go out from me!' So no one stood with him while Joseph made himself known to his brothers." **GENESIS 45:1**

TRUE OR FALSE

CIRCLE THE CORRECT WORD:

2. "And he (**SANG**, **WEPT**) aloud, and the Egyptians and the house of Pharaoh heard it." **GENESIS 45:2**

TRUE OR FALSE:

3. "Then Joseph said to his brothers, 'I am Joseph; does my father still live?' " **GENESIS 45:3**

TRUE OR FALSE

"AND JOSEPH SAID TO HIS BROTHERS, 'PLEASE COME NEAR TO ME.' AND THEY CAME NEAR. AND HE SAID: 'I AM JOSEPH YOUR BROTHER, WHOM YOU SOLD INTO EGYPT. BUT NOW, DO NOT THEREFORE BE GRIEVED NOR ANGRY WITH YOURSELVES BECAUSE YOU SOLD ME HERE; FOR GOD SENT ME BEFORE YOU TO PRESERVE LIFE. ' " GENESIS 45:4-5

CIRCLE THE CORRECT WORD:

4. Joseph also said to his brothers, "So now it was not you who sent me here, but (**ME**, **GOD**); and He has made me a father to Pharaoh, and lord of all his house, and a ruler throughout all the land of Egypt." **GENESIS 45:8**

FILL IN THE BLANK:

5. Then Joseph said, "You shall _____ in the land of Goshen, and you shall be near to me, you and your children, your children's children, your flocks and your herds, and all that you have." **GENESIS 45:10**

TRUE OR FALSE:

6. Joseph told his brothers, "So you shall tell my father of all my glory in Egypt, and of all that you have seen; and you shall hasten and bring my father down here." **GENESIS 45:13**

TRUE OR FALSE

7. Joseph "kissed all his brothers and wept over them, and after that his brothers talked with him." **GENESIS 45:15**

TRUE OR FALSE

32. JOSEPH REVEALS HIMSELF TO HIS BROTHERS (GENESIS 45:1-16)

C P D Z F I H D J N H N E F U
 T U W R D G B R O T H E R S T
 C H A D O E A Q T A T K P O O
 J E P S E U S F A M I N E J M
 N T H E V L L A A Y T B I W J
 W E Q Z S A I C E D O G Y S K
 N N D E I O E V A L R C B S G
 Y D P L G F J D E D P D B I H
 J F I N O Y U U I R E W P A T
 T R A R O S P J U V A S P G P
 N A T T R F T T E L O N S W E
 A Z A O H U T K N Q I R C I W
 S E L B N E L S Q U R F P E K
 D W E L L T R E P Q W K E A P
 L M B H H Q D M R T P I Y F D

BROTHERS
 DELIVERANCE
 DWELL
 EGYPT
 FAMINE
 FATHER

GOD
 GOSHEN
 JOSEPH
 KISSED
 LIFE
 NEAR

PLEASED
 PROVIDE
 RULER
 SOLD
 WEPT



32. JOSEPH REVEALS HIMSELF TO HIS BROTHERS (GENESIS 45:1-16)

MEMORY VERSE:

"Therefore be merciful, just as your Father also is merciful." LUKE 6:36

TRUE OR FALSE:

1. "Then Joseph could not restrain himself before all those who stood by him, and he cried out, 'Make everyone go out from me!' So no one stood with him while Joseph made himself known to his brothers." **GENESIS 45:1**

TRUE OR FALSE

FILL IN THE BLANKS:

2. "And he _____ aloud, and the Egyptians and the house of Pharaoh heard it."
GENESIS 45:2
3. "Then Joseph said to his brothers, 'I am Joseph; does my father still _____?' "**GENESIS 45:3**
"AND JOSEPH SAID TO HIS BROTHERS, 'PLEASE COME NEAR TO ME.' AND THEY CAME NEAR. AND HE SAID: 'I AM JOSEPH YOUR BROTHER, WHOM YOU SOLD INTO EGYPT. BUT NOW, DO NOT THEREFORE BE GRIEVED NOR ANGRY WITH YOURSELVES BECAUSE YOU SOLD ME HERE; FOR GOD SENT ME BEFORE YOU TO PRESERVE LIFE. ' " GENESIS 45:4-5

FILL IN THE BLANKS:

4. Joseph also said to his brothers, "So now it was not you who sent me here, _____; and He has made me a father to Pharaoh, and lord of all his house, and a ruler throughout all the land of Egypt." **GENESIS 45:8**
5. Then Joseph said, "You shall _____ in the land of Goshen, and you shall be near to me, you and your children, your children's children, your flocks and your herds, and all that you have." **GENESIS 45:10**
6. Joseph told his brothers, "So you shall tell my father of all my glory in Egypt, and of all that you have seen; and you shall hasten and _____ _____ _____ down here."
GENESIS 45:13

TRUE OR FALSE:

7. Joseph "kissed all his brothers and wept over them, and after that his brothers talked with him." **GENESIS 45:15**

TRUE OR FALSE

32. JOSEPH REVEALS HIMSELF TO HIS BROTHERS (GENESIS 45:1-16)

G S Q B A F D X D A K K O V L G T K H C P V V B A
 S P I Q Z V Q N W G K W I U S P K J T V Z K E K C
 N P L J E I C A H W R L R U E S W F J U F M V J L
 B R H I M D U Y D P E P R O V I D E Y B B O V K P
 K X R C D O E W K A E W F A J O I Y R N X Z L L A
 K O T E W N E L I L N S W E P T U T P Y G E A M I
 O S Y T L L J Q I U C W O D M T M T R E H T A F E
 J L O C L U K U E V V Z Y J G W F W D H K X I X Y
 Q K A J Q H R Q P T E O X D O I D L C X M A L Y A
 S W V W X I S T I O C R D W V H I G G D Z M R R Q
 P V C Y N E A R Y M D A A T S J S H S E L Z U T A
 M J A J I U M H B J C E F N P D M X Q S I B U T O
 B M L T T A E T B K H M S L C P A V U A Z T C C Y
 B W F N A F F T P G R M B S T E Y S M E F P Q M E
 O E O A L F I B P H E N E A I O E U J L Z Z N P A
 H L Z A M T L R R G M U H O W K D X Q P M F R M E
 S V M S B I J R Y O Q D T A B L O H L A D V M L Q
 S D F L Z Q N W F D T L L P H O N U J U K F W C U
 R D M P Z H T E O V N H U A J U E Q T V X H B S T
 V Z Q U N A A P J B Y U E D Y I H T W A U N I G V
 N Z S T K U A D W G M L W R K I S P K E Y E F E S
 G O Q N O U U N O C A L Q Y S B O L M I E E W Y E
 D W V D B T E K S G S Y N S P R G J L S E M L P T
 P S O L D T N B S Z V H I M G W E B U G J J J W K
 K H P R H D Q C I H Y M S P K G P J G J A Q B I N

BROTHERS
 DELIVERANCE
 DISMAYED
 DWELL
 EGYPT
 FAMINE

FATHER
 GOD
 GOSHEN
 JOSEPH
 KISSED
 LIFE

NEAR
 PLEASED
 PROVIDE
 RULER
 SOLD
 WEPT



32. JOSEPH REVEALS HIMSELF TO HIS BROTHERS (GENESIS 45:1-16)

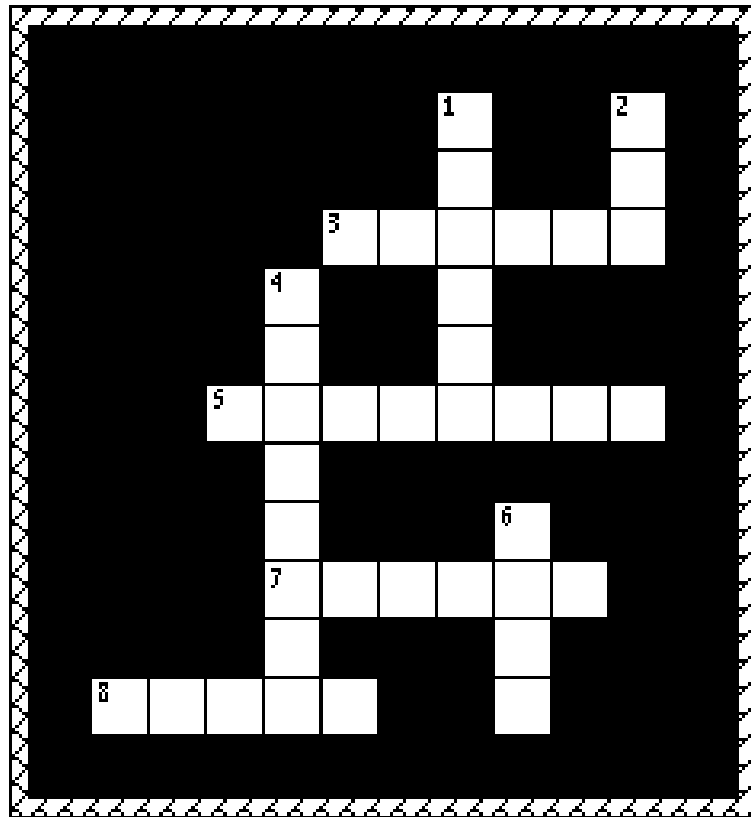

- 4 DOWN "Therefore be _____, just as your Father also is merciful." **LUKE 6:36**
- 5 ACROSS "Then Joseph could not restrain himself before all those who stood by him, and he cried out, 'Make everyone go out from me!' So no one stood with him while Joseph made himself known to his _____." **GENESIS 45:1**
- 6 DOWN "And he _____ aloud, and the Egyptians and the house of Pharaoh heard it." **GENESIS 45:2**
- 1 DOWN "Then Joseph said to his brothers, 'I am _____; does my father still live?'" **GENESIS 45:3**
- 2 DOWN Joseph also said to his brothers, "So now it was not you who sent me here, but _____; and he has made me a father to Pharaoh, and lord of all his house, and a ruler throughout all the land of Egypt." **GENESIS 45:8**
- 8 ACROSS Then Joseph said, "You shall _____ in the land of Goshen, and you shall be near to me, you and your children, your children's children, your flocks and your herds, and all that you have." **GENESIS 45:10**
- 7 ACROSS Joseph told his brothers, "So you shall tell my _____ of all my glory in Egypt, and of all that you have seen; and you shall hasten and bring my father down here." **GENESIS 45:13**
- 3 ACROSS Joseph "_____ all his brothers and wept over them, and after that his brothers talked with him." **GENESIS 45:15**

Bible Story 33

JACOB MOVES TO EGYPT

GENESIS 45:17-50:26

33. JACOB MOVES TO EGYPT (GENESIS 45:17-50:26)



"And take your father and your households, and come unto me: and I will give you the good of the land of Egypt, and ye shall eat the fat of the land."

GENESIS 45:18

33. JACOB MOVES TO EGYPT

(GENESIS 45:17-50:26)

MEMORY VERSE:

"And we know that all things work together for good to those who love God." ROMANS 8:28

CIRCLE THE CORRECT WORDS:

1. "Pharaoh said to Joseph, 'Say to your brothers, "Do this: Load your beasts and depart; go to the land of Canaan. Bring your father and your households and come to me; I will give you the (BEST , WORST) of the land of Egypt, and you will eat of the fat of the land." ' " **GENESIS 45:17-18**
2. Then Joseph's brothers "went up out of Egypt, and came to the land of Canaan to Jacob their father. And they told him, saying, 'Joseph is still alive, and he is governor over all the land of Egypt.' And Jacob's heart stood still, because he did not (LIKE, BELIEVE) them." **GENESIS 45:25-26**
3. "Then God spoke to Israel in the visions of the night, and said, 'Jacob, Jacob!' And he said, 'Here I am.' And He said, 'I am God, the God of your father; do not fear to go down to Egypt, for I will make of you a great (NATION, CHARIOT) there. I will go down with you to Egypt, and I will surely bring you up again.'" **GENESIS 46:2-4**
4. "So they took their livestock and their goods, which they had acquired in the land of Canaan, and went to (EGYPT, AMERICA), Jacob and all his descendants with him." **GENESIS 46:6**
5. Now when Jacob arrived in Egypt "Joseph made ready his chariot and went up to Goshen to meet his father Israel; and he presented himself to him, and fell on his neck and (PAINTED, WEPT) on his neck a good while." **GENESIS 46:29**
6. "Pharaoh spoke to Joseph, saying, 'Your father and your brothers have come to you. The land of Egypt is before you. Have your father and brothers dwell in the best of the land; let them dwell in the land of (GOOSHIE, GOSHEN).' " **GENESIS 47:5-6**
7. "When the time drew near that Israel must die, he called his son Joseph and said to him, 'Now if I have found favor in your sight, please put your hand under my thigh, and deal kindly and truly with me. Please do not (BURY, FEED) me in Egypt, but let me lie with my fathers; you shall carry me out of Egypt and bury me in their burial place.' And he said, 'I will do as you have said.' " **GENESIS 47:29-30**

TRUE OR FALSE:

8. "When Jacob had finished commanding his sons, he drew his feet up into the bed and breathed his last, and was gathered to his people. Then Joseph fell on his father's face, and wept over him, and kissed him." **GENESIS 49:33-50:1**

TRUE OR FALSE

9. When Joseph's brothers saw that their father was dead, they said, "Perhaps Joseph will love us, and may actually repay us for all the kind things which we did for him." **GENESIS 50:15**

TRUE OR FALSE

10. "Joseph said to them, 'Do not be afraid, for am I in the place of God? But as for you, you meant evil against me; but God meant it for good, in order to bring it about as it is this day, to save many people alive.' " **GENESIS 50:19-20**

TRUE OR FALSE

"JOSEPH SAID TO HIS BRETHREN, '...GOD WILL SURELY VISIT YOU, AND BRING YOU OUT OF THIS LAND TO THE LAND OF WHICH HE SWORE TO ABRAHAM, TO ISAAC, AND TO JACOB.' " **GENESIS 50:24**

33. JACOB MOVES TO EGYPT

(GENESIS 45:17-50:26)

M U L T I P L I E D D E H J E
F A T H E R M A C H P E L A H
E K D L R L S V N H B D B T H
G S O Z S S D P R A W R E Q M
Y J O J E I D A H E T H I H U
P F G O N R I L L A C I E N N
T R L U I M R L O C R S O L G
O C V R F B F B A H S A U N C
D R O N I Y N V L A E C O U A
O L N E R R E B N E V S O H J
N S E Y C U V A J L S A U M K
K P H J A B M A J G I S D O E
E E S P S V C W L E O V E V H
Y F O E J O S E P H H D E D R
S Z G N B B R O T H E R S D L

BLESSED
BRING
BROTHERS
BURY
CAVE
COME
DONKEYS

DWELL
EGYPT
EPHRAIM
EVIL
FATHER
GOD

GOOD
GOSHEN
HOUSEHOLDS
JACOB
JOSEPH
JOURNEY

MACHPELAH
MANASSEH
MULTIPLIED
NATION
PHARAOH
SACRIFICES

33. JACOB MOVES TO EGYPT

(GENESIS 45:17-50:26)

MEMORY VERSE:

"And we know that all things work together for good to those who love God." ROMANS 8:28

FILL IN THE BLANKS:

1. "Pharaoh said to Joseph, 'Say to your brothers, "Do this: Load your beasts and depart; go to the land of Canaan. Bring your father and your households and come to me; I will give you the _____ of the land of Egypt, and you will eat of the fat of the land.'" " **GENESIS 45:17-18**
2. Then Joseph's brothers "went up out of Egypt, and came to the land of Canaan to Jacob their father. And they told him, saying, 'Joseph is still alive, and he is governor over all the land of Egypt.' And Jacob's heart stood still, because he did not _____ them." **GENESIS 45:25-26**
3. "Then God spoke to Israel in the visions of the night, and said, 'Jacob, Jacob!' And he said, 'Here I am.' And He said, 'I am God, the God of your father; do not fear to go down to Egypt, for I will _____ make of you a great _____ there. I will go down with you to Egypt, and I will surely bring you up again.'" **GENESIS 46:2-4**

CIRCLE THE CORRECT WORDS:

4. "So they took their livestock and their goods, which they had acquired in the land of Canaan, and went to (**EGYPT**, **AMERICA**), Jacob and all his descendants with him." **GENESIS 46:6**
5. Now when Jacob arrived in Egypt "Joseph made ready his chariot and went up to Goshen to meet his father Israel; and he presented himself to him, and fell on his neck and (**PAINTED**, **WEPT**) on his neck a good while." **GENESIS 46:29**
6. "Pharaoh spoke to Joseph, saying, 'Your father and your brothers have come to you. The land of Egypt is before you. Have your father and brothers dwell in the best of the land; let them dwell in _____ the land of (**GOOSHIE**, **GOSHEN**).'" **GENESIS 47:5-6**

FILL IN THE BLANKS:

7. "When the time drew near that Israel must die, he called his son Joseph and said to him, 'Now if I have found favor in your sight, please put your hand under my thigh, and deal kindly and truly with me. Please do not _____ me in Egypt, but let me lie with my fathers; you shall carry me out of Egypt and bury me in their burial place.' And he said, 'I will do as you have said.'" **GENESIS 47:29-30**
8. "When _____ had finished commanding his sons, he drew his feet up into the bed and breathed his last, and was gathered to his people. Then Joseph fell on his father's face, and wept over him, and kissed him." **GENESIS 49:33-50:1**
9. When Joseph's brothers saw that their father was dead, they said, "Perhaps Joseph will _____ us, and may actually repay us for all the evil which we did to him." **GENESIS 50:15**

TRUE OR FALSE:

10. "Joseph said to them, 'Do not be afraid, for am I in the place of God? But as for you, you meant evil against me; but God meant it for good, in order to bring it about as it is this day, to save many people alive.'" **GENESIS 50:19-20**

TRUE OR FALSE

"JOSEPH SAID TO HIS BRETHREN, '...GOD WILL SURELY VISIT YOU, AND BRING YOU OUT OF THIS LAND TO THE LAND OF WHICH HE SWORE TO ABRAHAM, TO ISAAC, AND TO JACOB.'" GENESIS 50:24

33. JACOB MOVES TO EGYPT

(GENESIS 45:17-50:26)

P V L F S K G C W X T T U X U E E V K G Q G N R I H D U S M
 R C P V M B W V Z D L W I V M I E F B E U C M S C Z R G F Q
 X A U I J C A C O F A B I S J S J H I Y T M Q M C C Z B Q Y
 O L T O T D F C A H J H B B R O T H E R S N P C M S M D V R
 S O N N A W S H K O O J R U Q G D N F U V Q L U R G Y O X X
 L Z D R A N U A S B O A W X L J O E W W S R J R X I A N R T
 K M R H E I T E C E A Y R H J P N E L I G N I R B F E Z B P
 W F A I U H P R U R P K G A T Z K M J A E U D S N E H S O G
 V M Z U E H T E N H I P T U H F E J B C T H E S S A N A M K
 J Q E A N E O A U T A F K Q W P Y Q B L K M D J G L M F I Z
 X S M F Q P M M F L D G I T K B S V K P M E R L B B X N U O
 W Q D F M I J Q D U Y K W C M X A E J A U S M H I K Z X Q V
 E V B U R M K N L W S G M P E M V V K I L Z J A V M U A H L
 L P W T N J A C O B M P I I L S M V U E T P L L S I I D C C
 V B Q Q A Y G L A Q U S U L A M U L M Y I J P E M U J P C Y
 D Q X H Y B H L U V M O M J U R O A X A P H O P K X L U N Y
 D J J A Q B G E H N E T F B G Z H I Y Q L D L H I W M K U P
 Z I I O U P D W F O S W O J C X Z P R A I C T C R V P I K D
 Z C T U U P V D L I U I E H V I X L E O E U P A K K P P S D
 O T A U Q R B Y Y S E S P T U Z A R T Y D U N M Q G E R U A
 W C L T T Y N M H V J H E N O I T A N D N S R P Y P C Q N W
 H J B T H F G E E U M D K H B F M U T E B Y A B C H H I E Z
 Q W Z D T O C A L V O J J J O Z Z U C S Y J P N Z K M J S C
 I Y Z D T J Z S M G I D F Y N L B C M S Z G L S A H X L X P
 L J N Q R W H V D U G L Y R H X D Q P E A A M L K C I J T Y
 H T K C R S K Y O O O U T D X D T S M L M K M P R O V V I E
 T N O U W S K K I A O O W C A K P O M B U R T H V V M R L J
 Y E G Y P T R W R D V G U G U N C N L E E B F L Z N T R E R
 O A B J P I E L F D S L G S V M Z R C A D N H Q Y J Q K I L
 A S H K N A N W Y W P O H Q A Y F L S E K Y D U E L V J A P

BLESSED	DWELL	GOOD	MACHPELAH
BRING	EGYPT	GOSHEN	MANASSEH
BROTHERS	EPHRAIM	HOUSEHOLDS	MULTIPLIED
BURY	EVIL	JACOB	NATION
CAVE	FATHER	JOSEPH	PHARAOH
COME	GOD	JOURNEY	SACRIFICES
DONKEYS			

33. JACOB MOVES TO EGYPT (GENESIS 45:17-50:26)

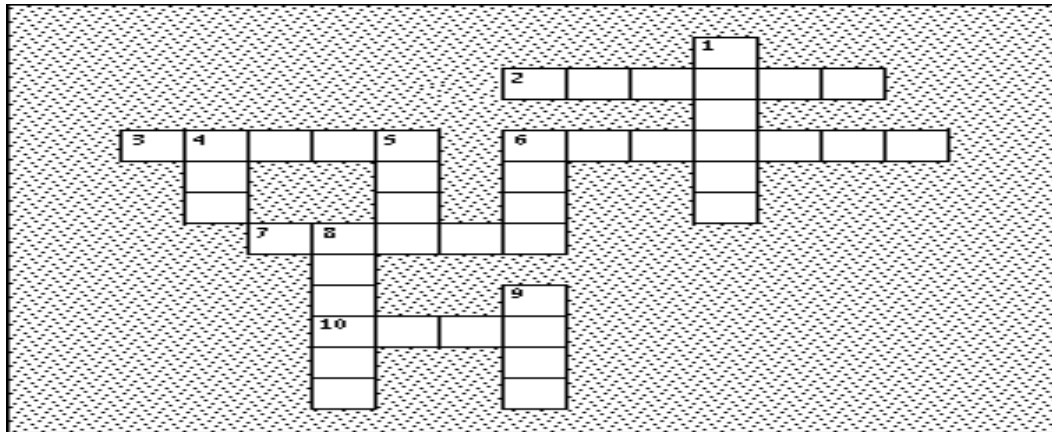

- 4 DOWN "And we know that _____ things work together for good to those who love God." **ROMANS 8:28**
- 6 DOWN "Pharaoh said to Joseph, 'Say to your brothers, "Do this: Load your beasts and depart; go to the land of Canaan. Bring your father and your households and come to me; I will give you the _____ of the land of Egypt, and you will eat of the fat of the land." ' " **GENESIS 45:17-18**
- 6 ACROSS "Then Joseph's brothers "went up out of Egypt, and came to the land of Canaan to Jacob their father. And they told him, saying, 'Joseph is still alive, and he is governor over all the land of Egypt.' And Jacob's heart stood still, because he did not _____ them." **GENESIS 45:25-26**
- 1 DOWN "Then God spoke to Israel in the visions of the night, and said, 'Jacob, Jacob!' And he said, 'Here I am.' And He said, 'I am God, the God of your father; do not fear to go down to Egypt, for I will make of you a great _____ there. I will go down with you to Egypt, and I will surely bring you up again.' " **GENESIS 46:2-4**
- 7 ACROSS "So they took their livestock and their goods, which they had acquired in the land of Canaan, and went to _____, Jacob and all his descendants with him." **GENESIS 46:6**
- 9 DOWN "Now when Jacob arrived in Egypt "Joseph made ready his chariot and went up to Goshen to meet his father Israel; and he presented himself to him, and fell on his neck and _____ on his neck a good while." **GENESIS 46:29**
- 8 DOWN "Pharaoh spoke to Joseph, saying, 'Your father and your brothers have come to you. The land of Egypt is before you. Have your father and brothers dwell in the best of the land; let them dwell in the land of _____.' " **GENESIS 47:5-6**
- 5 DOWN "When the time drew near that Israel must die, he called his son Joseph and said to him, 'Now if I have found favor in your sight, please put your hand under my thigh, and deal kindly and truly with me. Please do not _____ me in Egypt, but let me lie with my fathers; you shall carry me out of Egypt and bury me in their burial place.' And he said, 'I will do as you have said.' " **GENESIS 47:29-30**
- 3 ACROSS "When _____ had finished commanding his sons, he drew his feet up into the bed and breathed his last, and was gathered to his people. Then Joseph fell on his father's face, and wept over him, and kissed him." **GENESIS 49:33-50:1**
- 10 ACROSS "When Joseph's brothers saw that their father was dead, they said, "Perhaps Joseph will _____ us, and may actually repay us for all the evil which we did to him." **GENESIS 50:15**
- 2 ACROSS "Joseph said to them, 'Do not be _____ for am I in the place of God? But as for you, you meant evil against me; but God meant it for good, in order to bring it about as it is this day, to save many people alive.' " **GENESIS 50:19-20**

Bible Story 34

THE SLAVERY OF THE ISRAELITES

EXODUS 1:1-14; 2:23-24

34. THE SLAVERY OF THE ISRAELITES

(EXODUS 1:1-14; 2:23-24)



"And the Egyptians made the children of Israel to serve with rigour: and they made their lives bitter with hard bondage, in mortar, and in brick, and in all manner of service in the field: all their service, wherein they made them serve, was with rigour."

EXODUS 1:13-14

34. THE SLAVERY OF THE ISRAELITES

(EXODUS 1:1-14; 2:23-24)

MEMORY VERSE:

"Come to Me, all you who labor and are heavy laden, and I will give you rest."
MATTHEW 11:28

TRUE OR FALSE:

1. "The children of Israel were fruitful and increased abundantly, multiplied and grew exceedingly mighty; and the land was filled with them." **EXODUS 1:7**
TRUE OR FALSE
2. Now there arose a new king over Egypt, who knew Joseph. **EXODUS 1:8**
TRUE OR FALSE

CIRCLE THE CORRECT WORDS:

3. The king "said to his people, 'Look, the people of the children of Israel are (**MORE, LESS**) and mightier than we. " **EXODUS 1:9**
4. "They set (**ROOFS, TASKMASTERS**) over them to afflict them with their burdens." **EXODUS 1:11**
5. "They built for Pharaoh supply (**HUTS, CITIES**), Pithom and Raamses." **EXODUS 1:11**

TRUE OR FALSE:

6. "But the more they afflicted them, the more they multiplied and grew." **EXODUS 1:12**
TRUE OR FALSE
7. So the Egyptians made the children of Israel to leave Egypt. **EXODUS 1:13**
TRUE OR FALSE

FILL IN THE BLANKS:

8. "And they made their lives bitter with hard bondage- in _____, in _____, and in all manner of service in the field." **EXODUS 1:14**

CIRCLE THE CORRECT WORD:

9. "All their service in which they made them serve was with (**RIGOR, TIGERS**)."
EXODUS 1:14

34. THE SLAVERY OF THE ISRAELITES

(EXODUS 1:1-14; 2:23-24)

U R E T T I B M A P C B Z R T
Q F N N L V A X N M Q R Z P F
S O M S G B Q T M L I B K I A
S P H Z R Q F Y R E E G C Q Y
I E T C I L F F A A I A H D Y
L O L K Q Y H L M S T K R T O
E O D B I E P F F G W R T S Y
G C R Z P L J I R D Z E O J I
Y T N A N E V O C U P F R M F
P F E F H N T O H E I O I Q V
T K U H Z K B V A P G T O R M
S B W N I V C Q W I K J F I S
B O N D A G E I R Z Q T T U V
J Y J G V Q I Z R C J E A L L
F G N I K T A U X B B J N S M

AFFLICT
BITTER
BONDAGE
BRICK

COVENANT
EGYPT
FRUITFUL
ISRAEL

KING
MIGHTY
MORTAR
RIGOR

"Come to Me, all you who labor and are heavy laden, and I will give you rest."
MATTHEW 11:28

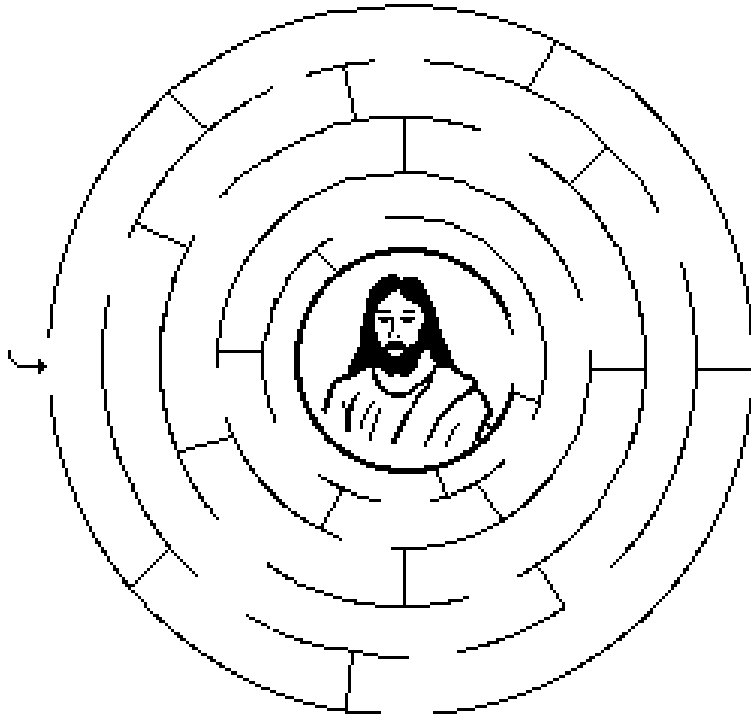

34. THE SLAVERY OF THE ISRAELITES

(EXODUS 1:1-14; 2:23-24)

MEMORY VERSE:

"Come to Me, all you who labor and are heavy laden, and I will give you rest."

MATTHEW 11:28

FILL IN THE BLANKS:

1. "The children of Israel were _____ and increased abundantly, _____ and grew exceedingly mighty; and the land was filled with them."
EXODUS 1:7

TRUE OR FALSE:

2. Now there arose a new king over Egypt, who knew Joseph. **EXODUS 1:8**
TRUE OR FALSE

FILL IN THE BLANKS:

3. The king "said to his people, 'Look, the people of the children of Israel are _____ and _____ than we.'" **EXODUS 1:9**
4. "They set _____ over them to afflict them with their burdens." **EXODUS 1:11**

TRUE OR FALSE:

5. They built for Pharaoh supply stores, Pithom and Raamses. **EXODUS 1:11**
TRUE OR FALSE
6. "But the more they afflicted them, the more they multiplied and grew." **EXODUS 1:12**
TRUE OR FALSE
7. So the Egyptians made the children of Israel to leave Egypt. **EXODUS 1:13**
TRUE OR FALSE

FILL IN THE BLANKS:

8. "And they made their lives bitter with hard bondage- in _____, in _____, and in all manner of service in the field." **EXODUS 1:14**
9. "All their service in which they made them serve was with _____." **EXODUS 1:14**

34. THE SLAVERY OF THE ISRAELITES

(EXODUS 1:1-14; 2:23-24)

E T S P Z Z J Z B H M U D W T R Q N E A
 L G P R O M W E H A J Q W S O E N U H O
 M E M X W F L M F B I T T E R N Y D T A
 G Y K O F M Y E V U T T K S M C M L L P
 M G B C H R J D A U A H I G N I K U U A
 B M B S I Q U W I R A T E I Y T H G I M
 P Q O L Q R T I O T S T P B J V A F W D
 M H H K I S B Q T T U I I O K T S L Q Y
 W V S W L Q N X R F E R Y N G C V Y N S
 N V S V H V A I N A U R B D H I Y H I M
 G E R J T P S T H D T L B A G L K L S U
 K G G X Y C L A I D N R P G D F W O V X
 B S V Y O B O L U Q Q W O E V F L I U S
 Y N N W P Q P V R O G I R M B A W R U E
 K B G E A T U B E C X P P A G C W F A J
 P K D L V J T Z A N N N Y G C C Z Y D M
 U K P V C I N Z F U A K F W Z H O X D G
 Y O K D A C D N F J A N O A H R A D W O
 F J S D L T R K T K Y B T F K E K F T V
 K Q P Z O C A O Q S Q C J M K M L B L S

AFFLICT
 BITTER
 BONDAGE
 BRICK

COVENANT
 EGYPT
 FRUITFUL
 ISRAEL

KING
 MIGHTY
 MORTAR
 RIGOR

"Come to Me, all you who labor and are heavy laden, and I will give you rest." MATTHEW 11:28

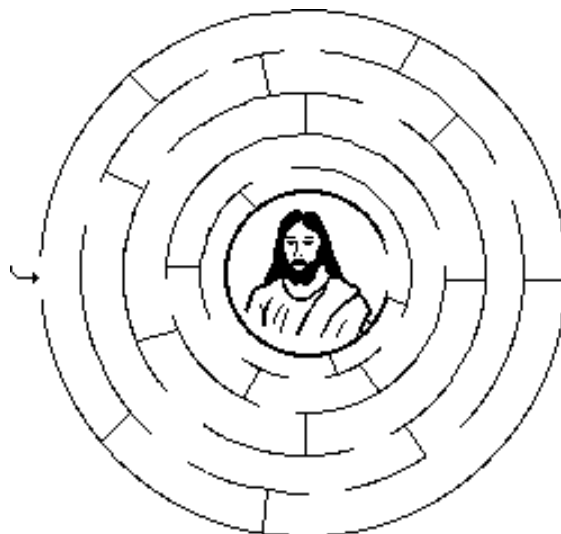

34. THE SLAVERY OF THE ISRAELITES

(EXODUS 1:1-14; 2:23-24)

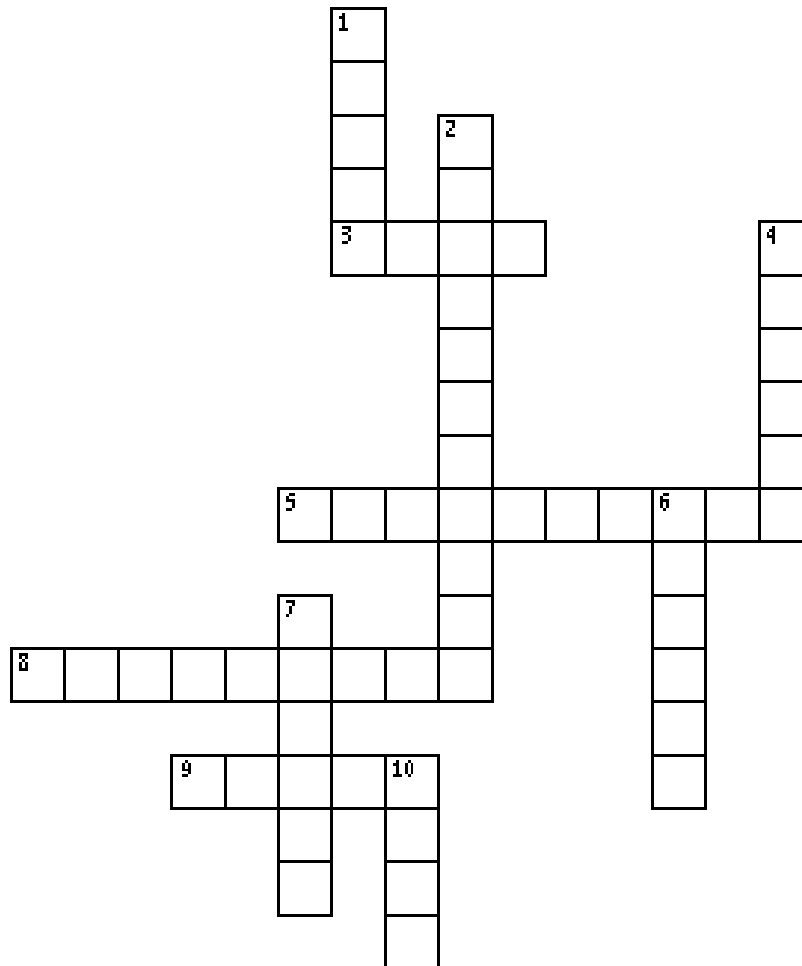

- 3 ACROSS "Come to Me, all you who labor and are heavy laden, and I will give you ____" **MATTHEW 11:28**
- 4 DOWN "The children of Israel were fruitful and increased abundantly, multiplied and grew exceedingly mighty; and the land was ____ with them." **EXODUS 1:7**
- 10 DOWN "Now there arose a new ____ over Egypt, who did not know Joseph." **EXODUS 1:8**
- 6 DOWN The king "said to his people, "Look, the people of the children of ____ are more and mightier than we." **EXODUS 1:9**
- 2 DOWN "They set ____ over them to afflict them with their burdens." **EXODUS 1:11**
- 7 DOWN "They built for Pharaoh supply ____, Pithom and Raamses." **EXODUS 1:11**
- 5 ACROSS "But the more they afflicted them, the more they ____ and grew." **EXODUS 1:12**
- 8 ACROSS "So the ____ made the children of Israel serve with rigor". **EXODUS 1:13**
- 9 ACROSS "And they made their lives bitter with hard bondage- in mortar, in ____, and in all manner of service in the field." **EXODUS 1:14**
- 1 DOWN "All their service in which they made them serve was with ____." **EXODUS 1:14**

Bible Story 35

MOSES IS BORN

EXODUS 2:1-10

35. MOSES IS BORN

(EXODUS 2:1-10)



"And when she could no longer hide him, she took for him an ark of bulrushes, and daubed it with slime and with pitch, and put the child therein; and she laid *it* in the flags by the river's brink."

EXODUS 2:3

35. MOSES IS BORN

(EXODUS 2:1-10)

MEMORY VERSE:

"The LORD is near to all who call upon Him, to all who call upon Him in truth."

PSALM 145:18

CIRCLE THE CORRECT WORDS:

1. Now when Moses' mother "saw that he was a beautiful child, she hid him three (**DAYS, MONTHS, YEARS**)."
EXODUS 2:2
2. "But when she could no longer hide him, she took an (**HOUSE, CAR, ARK**) of bulrushes for him, daubed it with asphalt and pitch, put the child in it, and laid it in the reeds by the river's bank."
EXODUS 2:3

TRUE OR FALSE:

3. Now Moses' sister "stood afar off, to know what would be done to him."
EXODUS 2:4
TRUE OR FALSE
4. "Then the daughter of Pharaoh came down to wash herself at the river."
EXODUS 2:5
TRUE OR FALSE

CIRCLE THE CORRECT WORD:

5. "And her maidens walked along the river's side; and when she saw the ark among the (**ROCKS, REEDS**), she sent her maid to get it."
EXODUS 2:5

TRUE OR FALSE:

6. Moses' sister said to Pharaoh's daughter, "Shall I go and call a nurse for you from the Hebrew women?"
EXODUS 2:7
TRUE OR FALSE
7. And Pharaoh's daughter said to her, "No!"
EXODUS 2:8
TRUE OR FALSE
8. "The child grew," and Moses' mother "brought him to Pharaoh's daughter, and he became her son."
EXODUS 2:10
TRUE OR FALSE

CIRCLE THE CORRECT WORD:

9. "So she called his name Moses saying, 'Because I drew him out of the (**SKY, WATER**).'"
EXODUS 2:10

35. MOSES IS BORN

(EXODUS 2:1-10)

M O T H E R L U P H
P A E R O M D D H E
Q T C I L F F A A B
L S E S O M Y Y R R
Q M M O N T H S A E
R E T H G U A D O W
F D E L L I F G H I
G M A R I V E R T P
F R U I T F U L I G
K A O R E T T I B C

AFFLICT
ARK
BITTER
DAUGHTER

FILLED
FRUITFUL
HEBREW

MONTHS
MORE
MOSES

MOTHER
PHARAOH
RIVER

HELP MOSES'S ARK FIND ITS' WAY TO THE PHARAOH'S DAUGHTER

Moses →

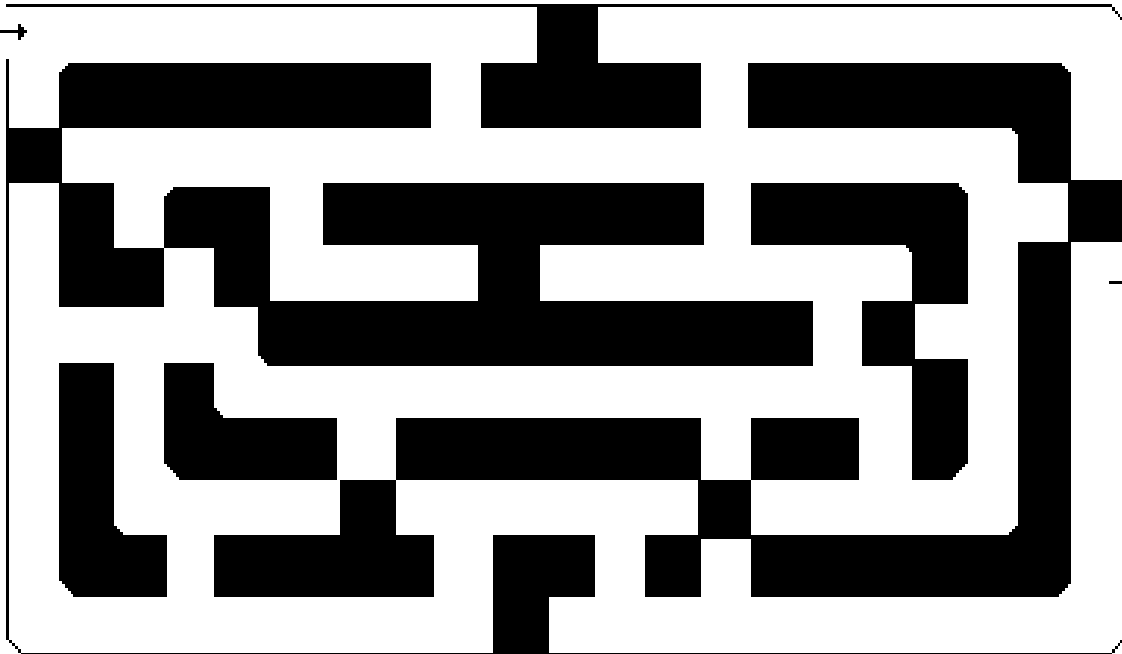

→ Pharaoh's
Daughter

35. MOSES IS BORN

(EXODUS 2:1-10)

MEMORY VERSE:

"The LORD is near to all who call upon Him, to all who call upon Him in truth."

PSALM 145:18

FILL IN THE BLANKS:

1. Now when Moses' mother "saw that he was a beautiful child, she hid him three _____."
EXODUS 2:2
2. "But when she could no longer hide him, she took an _____ of bulrushes for him, daubed it with asphalt and pitch, put the child in it, and _____ laid it in the reeds by the river's bank."
EXODUS 2:3

TRUE OR FALSE:

3. Now Moses' sister "stood afar off, to know what would be done to him." **EXODUS 2:4**
TRUE OR FALSE

FILL IN THE BLANK:

4. "Then the daughter of Pharaoh came down to wash herself at the _____." **EXODUS 2:5**

CIRCLE THE CORRECT WORD:

5. "And her maidens walked along the river's side; and when she saw the ark among the (ROCKS, REEDS), she sent her maid to get it." **EXODUS 2:5**

TRUE OR FALSE:

6. Moses' sister said to Pharaoh's daughter, "Shall I go and call a nurse for you from the Hebrew women?" **EXODUS 2:7**
TRUE OR FALSE
7. And Pharaoh's daughter said to her, "No!" **EXODUS 2:8**
TRUE OR FALSE

FILL IN THE BLANKS:

8. "The child grew," and Moses' mother "brought him to Pharaoh's daughter, and he became her _____." **EXODUS 2:10**
9. "So she called his name Moses saying, 'Because I drew him out of the _____.'" **EXODUS 2:10**

35. MOSES IS BORN

(EXODUS 2:1-10)

B P V V Q S D K M J Y C O G K A A X D M
 K K D C J L W O T K Q D J H K S K D D G
 K S D A I P W B Q F I L L E D V U P W O
 O P R L F U Q E H S U W W G R Y N B T V
 J P Z E C R L H R M Q K S R E V I R L S
 Q R Z O T T U F A B T I S D R E T T I B
 S X O Z T S I I U J E E I P E K U E A P
 P O W M C N I V T T H H A H N T D H O T
 M S H M O S E S S F T P G A C C L T A W
 B L Q F R D T I U H U I W R V I U L P B
 B M I M J E A O T A T L A A C L F U A H
 O K O Q W D E N T A T N F O C F L W D J
 H W L T Y R A D D U R Y O H H F Y Q Y Y
 S V H S H A L U S E R B U M R A H N S K
 S J T Q K E B H G N W B T V E W X I M P
 R X Y R J Z R I D H P P O B M L O S U G
 V W A V T E Z U Q Q T P M G Q W I V L K
 N E O P N E R A C N N E J C N W R U S G
 G C H I L D Z O U N K Y R Z Y Z F U E P
 D L A B A M N F M A B F K H M O Y A J S

AFFLICT
 ARK
 BITTER
 CHILD

DAUGHTER
 FILLED
 FRUITFUL
 HEBREW

MONTHS
 MORE
 MOSES
 MOTHER

PHARAOH
 REEDS
 RIVER
 SISTER

HELP MOSES'S ARK FIND ITS' WAY TO THE PHARAOH'S DAUGHTER

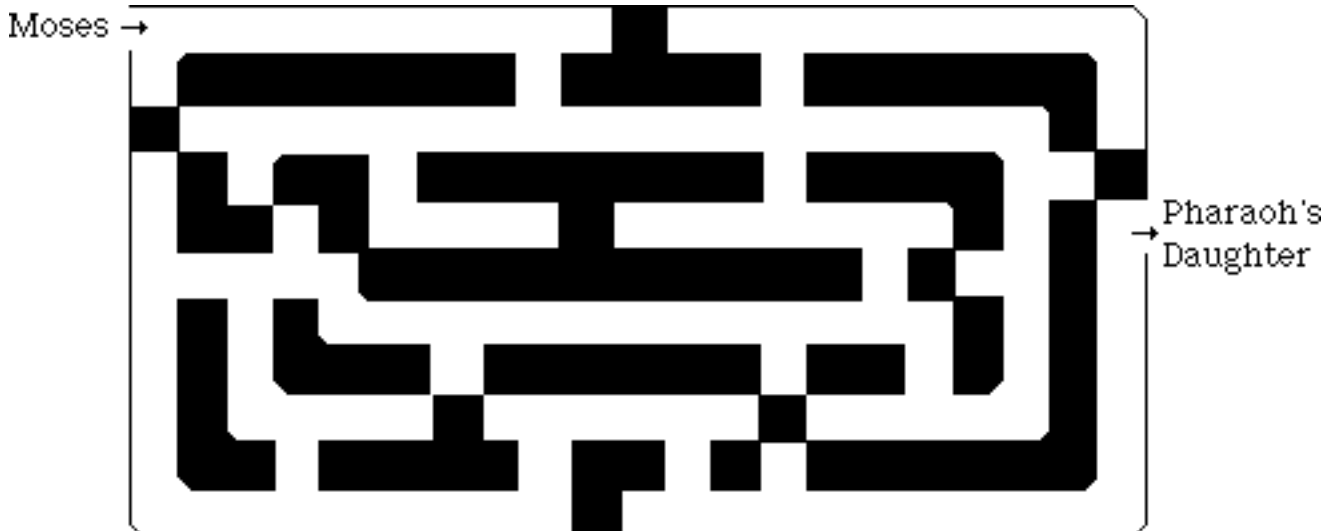

35. MOSES IS BORN

(EXODUS 2:1-10)

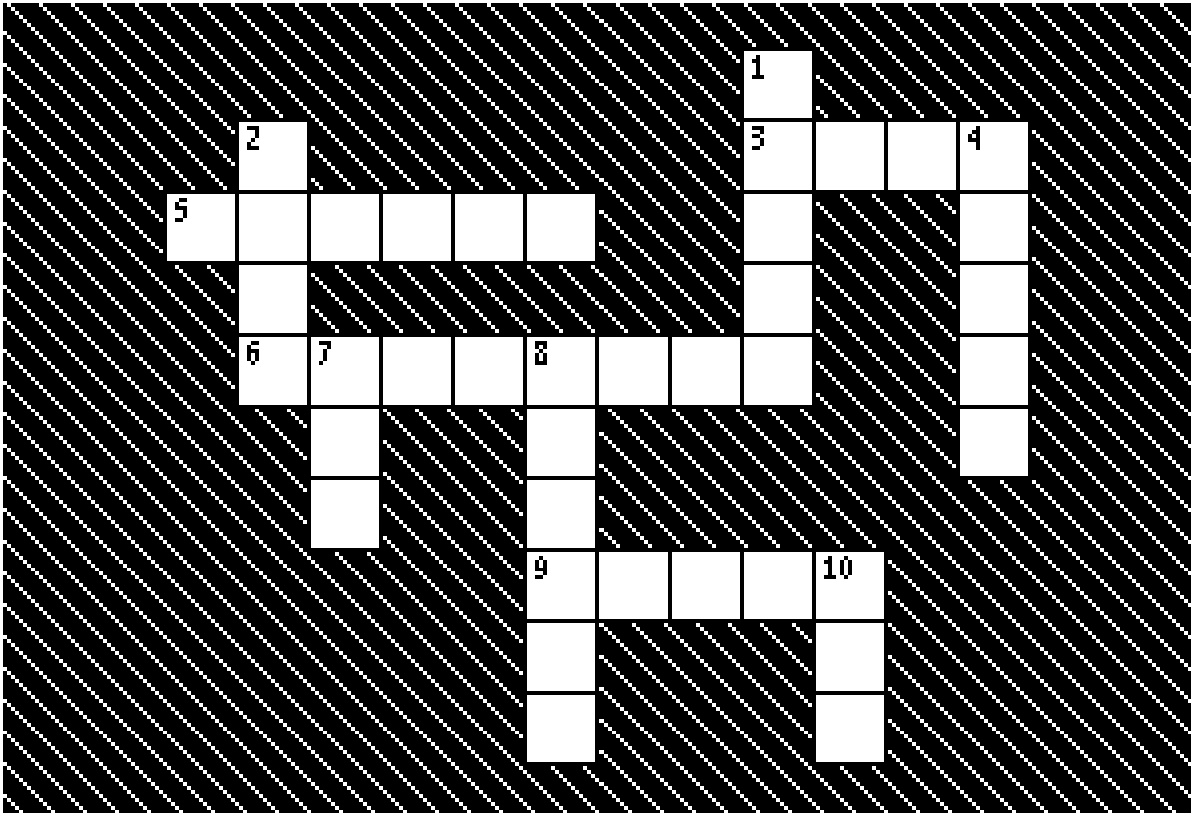

- 2 DOWN "The _____ is near to all who call upon Him, to all who call upon Him in truth." **PSALM 145:18**
- 5 ACROSS Now when Moses' mother "saw that he was a beautiful child, she hid him three _____." **EXODUS 2:2**
- 7 DOWN "But when she could no longer hide him, she took an _____ of bulrushes for him, daubed it with asphalt and pitch, put the child in it, and laid it in the reeds by the river's bank." **EXODUS 2:3**
- 3 ACROSS Now Moses' sister "stood _____ off, to know what would be done to him." **EXODUS 2:4**
- 4 DOWN "Then the daughter of Pharaoh came down to wash herself at the _____." **EXODUS 2:5**
- 9 ACROSS "And her maidens walked along the river's side; and when she saw the ark among the _____, she sent her maid to get it." **EXODUS 2:5**
- 8 DOWN Moses' sister said to Pharaoh's daughter, "Shall I go and call a nurse for you from the _____ women?" **EXODUS 2:7**
- 6 ACROSS "And Pharaoh's _____ said to her, 'Go.'" **EXODUS 2:8**
- 10 DOWN "The child grew," and Moses' mother "brought him to Pharaoh's daughter, and he became her _____." **EXODUS 2:10**
- 1 DOWN "So she called his name Moses saying, 'Because I drew him out of the _____.'" **EXODUS 2:10**

Bible Story 36

**THE
BURNING BUSH**

EXODUS 3:1-4:17

36. THE BURNING BUSH

(EXODUS 3:1-4:17)



"And the angel of the LORD appeared unto him in a flame of fire out of the midst of a bush: and he looked, and, behold, the bush burned with fire, and the bush was not consumed."

EXODUS 3:2

36. THE BURNING BUSH

(EXODUS 3:1-4:17)

MEMORY VERSE:

"My sheep hear My voice, and I know them, and they follow Me." JOHN 10:27

TRUE OR FALSE:

1. "Now Moses kept the flock of Jethro his father-in-law, the priest of Midian. And he led the flock to the back of the desert, and came to Horeb, the mountain of God." EXODUS 3:1
TRUE OR FALSE

CIRCLE THE CORRECT WORDS:

2. "And the Angel of the LORD appeared to him in a flame of fire from the midst of a (STORM, BUSH) So he looked, and behold, the bush burned with fire, but the bush was not consumed." EXODUS 3:2
3. "And the LORD said, 'Do not draw near this place. Take your sandals off your (HEAD, FEET), for the place where you stand is holy ground.'" EXODUS 3:5
4. The LORD said, "I have come down to deliver My people out of the hand of the Egyptians, and to bring them up from that land to a good and large land, to a land flowing with (MILK AND HONEY, SODA AND JAM)." EXODUS 3:8

FILL IN THE BLANKS:

5. "Then Moses said to God, 'Indeed, when I am come to the children of Israel and say to them, "The God of your fathers has sent me to you," and they say to me, "What is His name?" what shall I say to them?' And God said to Moses, ' ___ ___ ___ ___ ___.'" EXODUS 3:13-14

MOSES SAID, "BUT SUPPOSE THEY WILL NOT BELIEVE ME OR LISTEN TO MY VOICE; SUPPOSE THEY SAY, 'THE LORD HAS NOT APPEARED TO YOU.'" EXODUS 4:1

CIRCLE THE CORRECT WORDS:

6. "So the LORD said to him, 'What is that in your hand?' And he said, 'A rod.' And He said, 'Cast it on the ground.' So he cast it on the ground, and it became a (SERPENT, ELEPHANT); and Moses fled from it." EXODUS 4:2-3
7. "Then the LORD said to Moses, 'Reach out your hand and take it by the (HEAD, TAIL).'" EXODUS 4:4
8. "Furthermore the LORD said to him, 'Now put your hand in your bosom.' And he put his hand in his bosom, and when he took it out, behold, his hand was leprous, like (SNOW, COAL)." EXODUS 4:6

TRUE OR FALSE:

9. "And He said, 'Put your hand in your bosom again.' So he put his hand in his bosom again, and drew it out of his bosom, and behold, it was restored like his other flesh." EXODUS 4:7
TRUE OR FALSE

CIRCLE THE CORRECT WORD:

10. When Moses told the LORD that he did not speak well, "the LORD said to him, 'Who has made man's mouth? Or who makes the mute, the deaf, the seeing, or the blind? Have not I, the LORD? Now therefore, go, and I (WILL, WON'T) be with your mouth and teach you what you shall say.'" EXODUS 4:10-12

36. THE BURNING BUSH

(EXODUS 3:1-4:17)

S H E L B P N B Q X C J B T J
 A U O D Z H V I Z P C B K A Q
 N Q O R F Z Q A U E Q B E T R
 D S C E H I H T U O M M F N I
 A S S U O R P E L S I O J E L
 L I F U N V T M A G W S T P S
 S L M W G V A X N D Z E E R T
 J S B J L B Q T M E K S J E F
 Q D E M U S N O C T O N Z S A
 I J Y N G Q F Y G P K N Z N Y
 K F E R I F H L F Z Q O K R R
 T F N S R Y P I H H D R C P O
 I A M W H O I A M S R A T I D
 D O M Z Q E J O A U O A I Q Y
 Y P H K I L T V W B L R O D O

AARON
 BUSH
 FIRE
 I AM WHO I AM

LEPROUS
 LORD
 MOSES
 MOUTH

NOT CONSUMED
 ROD
 SANDALS
 SERPENT

WRITE DOWN THE LETTERS AS YOU COME TO THEM ON THE LINES BELOW

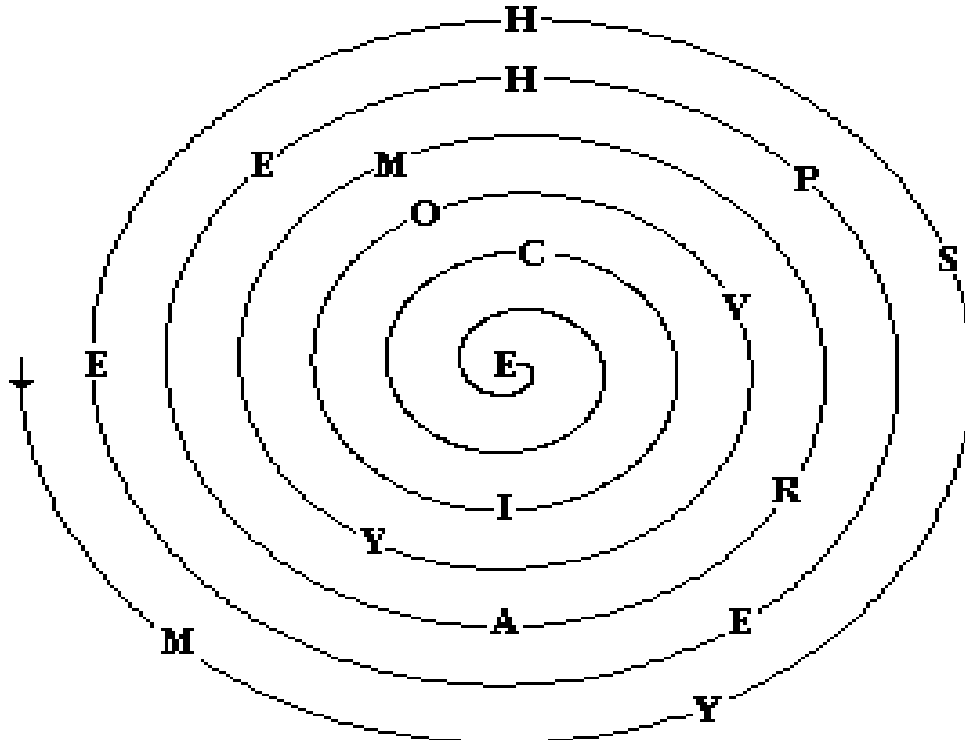

36. THE BURNING BUSH

(EXODUS 3:1-4:17)

MEMORY VERSE:

"My sheep hear My voice, and I know them, and they follow Me." JOHN 10:27

TRUE OR FALSE:

1. "Now Moses kept the flock of Jethro his father-in-law, the priest of Midian. And he led the flock to the back of the desert, and came to Horeb, the mountain of God." EXODUS 3:1
TRUE OR FALSE

FILL IN THE BLANKS:

2. "And the Angel of the LORD appeared to him in a flame of fire from the midst of a _____. So he looked, and behold, the bush burned with fire, but the bush _____ consumed." EXODUS 3:2
3. "And the LORD said, 'Do not draw near this place. Take your _____ off your feet, for the place where you stand is holy ground.'" EXODUS 3:5

CIRCLE THE CORRECT WORDS:

4. The LORD said, "I have come down to deliver My people out of the hand of the Egyptians, and to bring them up from that land to a good and large land, to a land flowing with (MILK AND HONEY, SODA AND JAM)." EXODUS 3:8

FILL IN THE BLANKS:

5. "Then Moses said to God, 'Indeed, when I am come to the children of Israel and say to them, "The God of your fathers has sent me to you," and they say to me, "What is His name?" what shall I say to them?' And God said to Moses, '_____' " EXODUS 3:13-14

MOSES SAID, "BUT SUPPOSE THEY WILL NOT BELIEVE ME OR LISTEN TO MY VOICE; SUPPOSE THEY SAY, 'THE LORD HAS NOT APPEARED TO YOU.' " EXODUS 4:1

CIRCLE THE CORRECT WORD:

6. "So the LORD said to him, 'What is that in your hand?' And he said, 'A rod.' And He said, 'Cast it on the ground.' So he cast it on the ground, and it became a (SERPENT, ELEPHANT); and Moses fled from it." EXODUS 4:2-3

FILL IN THE BLANKS:

7. "Then the LORD said to Moses, 'Reach out your hand and take it by the _____.'" EXODUS 4:4
8. "Furthermore the LORD said to him, 'Now put your hand in your bosom.' And he put his hand in his bosom, and when he took it out, behold, his hand was _____, like snow." EXODUS 4:6
9. "And He said, 'Put your hand in your bosom again.' So he put his hand in his bosom again, and drew it out of his bosom, and behold, it was _____ like his other flesh." EXODUS 4:7

CIRCLE THE CORRECT WORD:

10. When Moses told the LORD that he did not speak well, "the LORD said to him, 'Who has made man's mouth? Or who makes the mute, the deaf, the seeing, or the blind? Have not I, the LORD? Now therefore, go, and I (WILL, WON'T) be with your mouth and teach you what you shall say.'" EXODUS 4:10-12

36. THE BURNING BUSH (EXODUS 3:1-4:17)

U B Y P P Z O J E O T J A R B U G M F Q
 G P G M R Z Z W M B Q K Y R B T C A L N
 I M M D X O T Y D S A N D A L S Z S Y I
 C W O B N W M N W H H S Q W P O H V H S
 E R Q B O O F J E F A M U P P M K Y X V
 U N H O S H T T Q P U J Q N Y J K K O U
 X G V H L Q M C X V R T T K F K R W I U
 M K V S K I Q N O I U E H B O S E L R A
 K B G S W L S A H N T A S C S U N W F D
 U Y S R V H Q S I T S A T E J O C W Y D
 Y B N V J T V L T O U U S D W R V Z X W
 Y K U N X I P P A N T O M W S P C O D T
 R P B S W Y A U L H M U M E S E C A F L
 F U B G H O B M D R O L N K D L H K B A
 H Y N D E A Q T W I D E O I I G R U E O
 E F O P L V J N B H D N R E A H E N H A
 L N J K V E I D Z U O Q A P G G M U T P
 M T Q S R C C R Z A Q I A I W D Q D L A
 G G S I D A T A N L C X A Y A V N L U D
 M E F P D L C Z K L U N T M F B Y U W Y

AARON
 BUSH
 FIRE
 I AM WHO I AM

LEPROUS
 LORD
 MOSES
 MOUTH

NOT CONSUMED
 ROD
 SANDALS
 SERPENT

WRITE DOWN THE LETTERS AS YOU COME TO THEM ON THE LINES BELOW

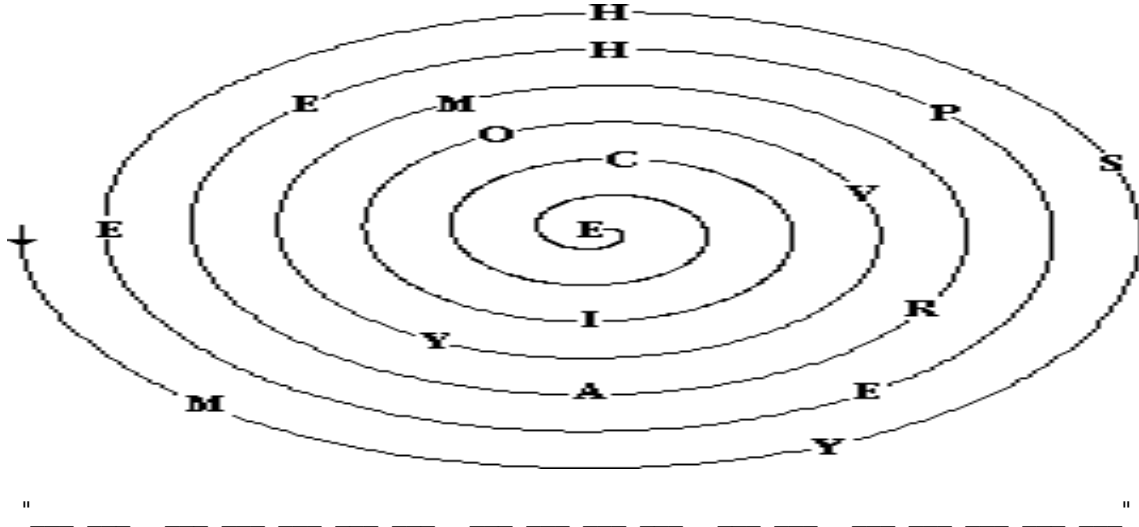

36. THE BURNING BUSH

(EXODUS 3:1-4:17)

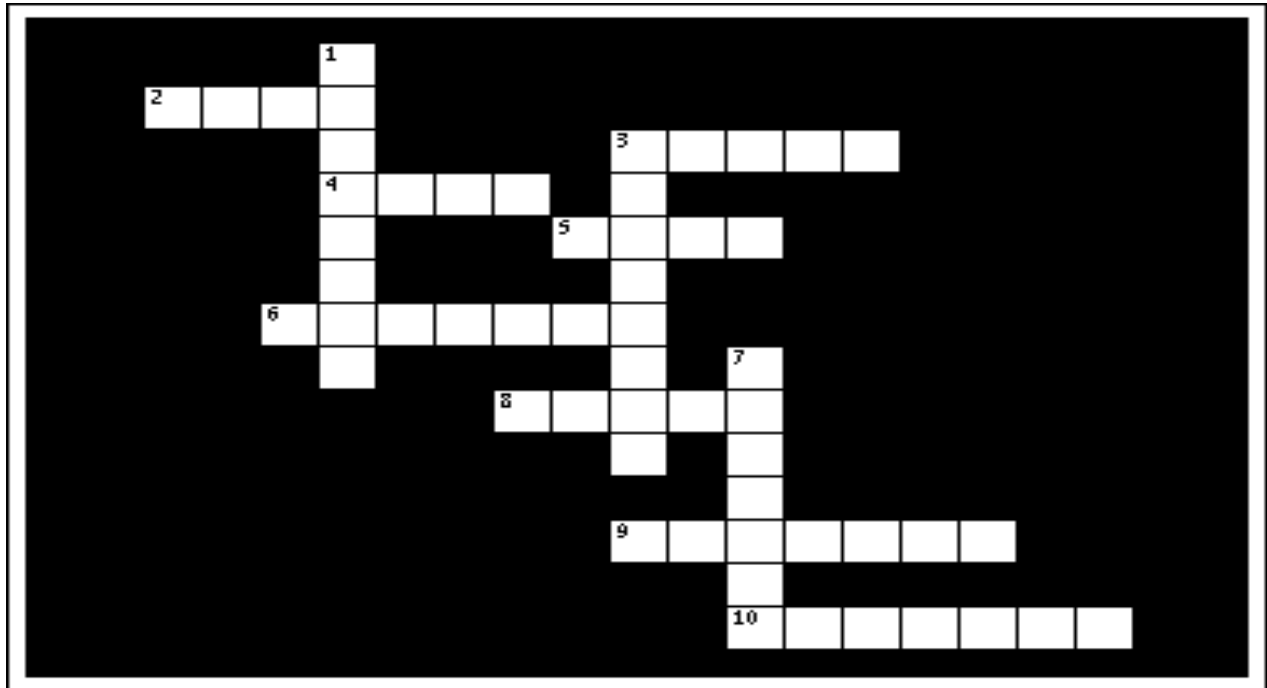

- 8 ACROSS "My sheep hear My _____, and I know them, and they follow Me." **JOHN 10:27**
- 3 DOWN "Now Moses kept the flock of Jethro his father-in-law, the priest of Midian. And he led the flock to the back of the desert, and came to Horeb, the _____ of God." **EXODUS 3:1**
- 5 ACROSS "And the Angel of the LORD appeared to him in a flame of fire from the midst of a _____. So he looked, and behold, the bush burned with fire, but the bush was not consumed." **EXODUS 3:2**
- 10 ACROSS "And the LORD said, 'Do not draw near this place. Take your _____ off your feet, for the place where you stand is holy ground.'" **EXODUS 3:5**
- 9 ACROSS The LORD said, "I have come down to deliver My people out of the hand of the Egyptians, and to bring them up from that land to a good and large land, to a land _____ with milk and honey." **EXODUS 3:8**
- 2 ACROSS "Then Moses said to God, 'Indeed, when I am come to the children of Israel and say to them, "The God of your fathers has sent me to you," and they say to me, "What is His _____" what shall I say to them?' And God said to Moses, 'I AM WHO I AM.' " **EXODUS 3:13-14**
- 6 ACROSS "So the LORD said to him, 'What is that in your hand?' And he said, 'A rod.' And He said, 'Cast it on the ground.' So he cast it on the ground, and it became a _____; and Moses fled from it." **EXODUS 4:2-3**
- 4 ACROSS "Then the LORD said to Moses, 'Reach out your hand and take it by the _____.'" **EXODUS 4:4**
- 7 DOWN "Furthermore the LORD said to him, 'Now put your hand in your bosom.' And he put his hand in his bosom, and when he took it out, behold, his hand was _____, like snow." **EXODUS 4:6**
- 1 DOWN "And He said, 'Put your hand in your bosom again.' So he put his hand in his bosom again, and drew it out of his bosom, and behold, it was _____ like his other flesh." **EXODUS 4:7**
- 3 ACROSS When Moses told the LORD that he did not speak well, "the LORD said to him, 'Who has made man's mouth? Or who makes the mute, the deaf, the seeing, or the blind? Have not I, the LORD? Now therefore, go, and I will be with your _____ and teach you what you shall say.'" **EXODUS 4:10-12**

Bible Story 37

THE TEN PLAGUES

EXODUS 7:14-11:10; 12:29-30

37. THE TEN PLAGUES

(EXODUS 7:14-11:10; 12:29-30)

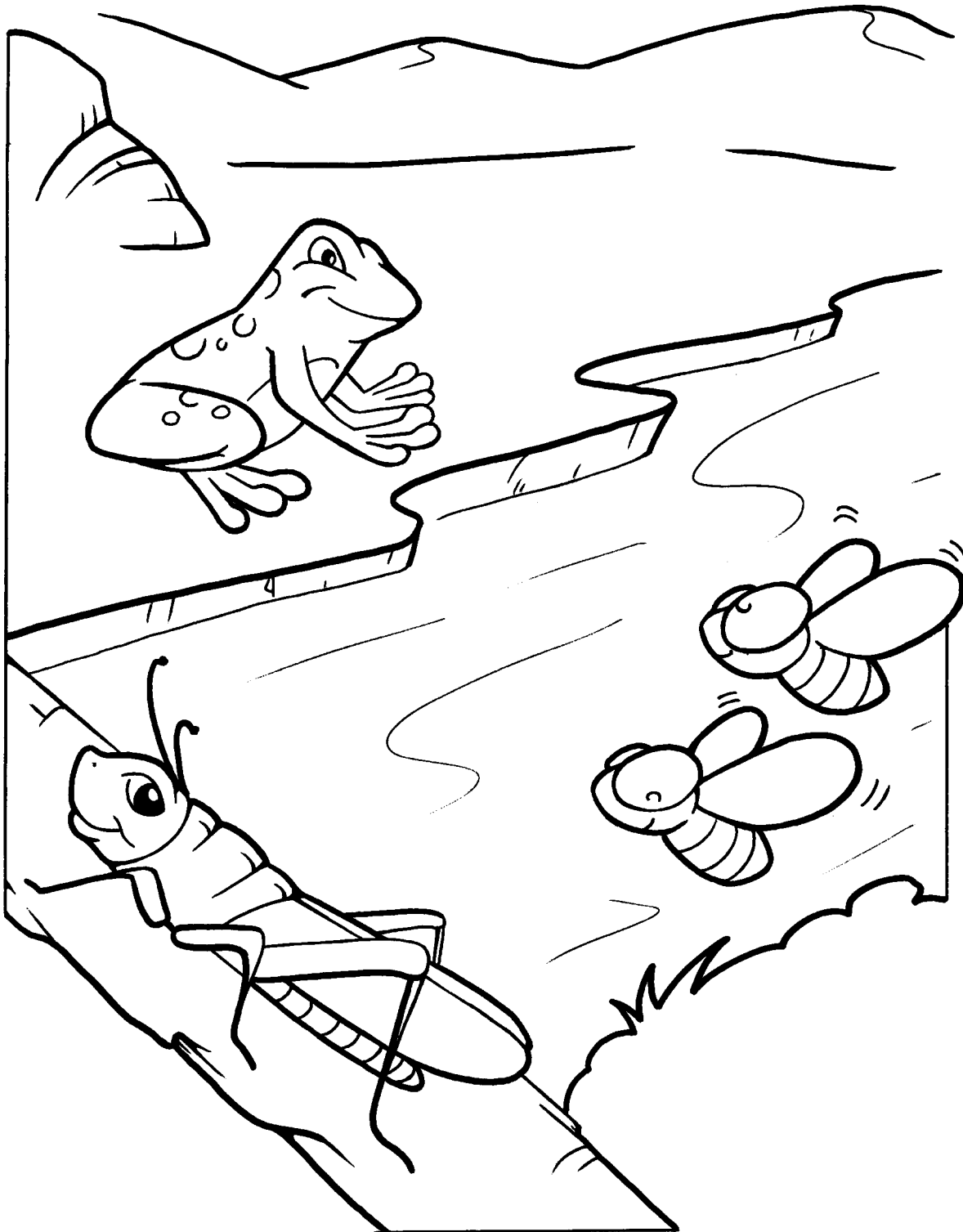

"And Moses and Aaron did all these wonders before Pharaoh: and the LORD hardened Pharaoh's heart, so that he would not let the children of Israel go out of his land."

EXODUS 11:10

37. THE TEN PLAGUES

(EXODUS 7:14-11:10; 12:29-30)

MEMORY VERSE:

"God delivers and rescues, and He works signs and wonders in heaven and on earth."
DANIEL 6:27

CIRCLE THE CORRECT WORDS:

1. "The LORD spoke to Moses, 'Say to Aaron, "Take your rod and stretch out your hand over the waters of Egypt, over their streams, over their rivers, over their ponds, and over all their pools of water, that they may become **(OIL, BLOOD)**.'" " EXODUS 7:19
2. "Then the LORD spoke to Moses, 'Say to Aaron, "Stretch out your hand with your rod over the streams, over the rivers, and over the ponds, and cause **(FROGS, SNAILS)** to come upon the land of Egypt.'" " EXODUS 8:5
3. "The LORD said to Moses, 'Say to Aaron, "Stretch out your rod, and strike the dust of the land, so that it may become **(LICE, MICE)** throughout all the land of Egypt.'" " EXODUS 8:16
4. "And the LORD said to Moses, 'Rise early in the morning and stand before Pharaoh as he comes out to the water. Then say to him, "Thus says the LORD: 'Let My people go, that they may serve Me. Or else, if you will not let My people go, behold, I will send swarms of **(BEES, FLIES)** on you and your servants, on your people and into your houses.'" " EXODUS 8:20-21
5. "Again the LORD said, "Behold, the hand of the LORD will be on your cattle in the field, on the horses, on the onkeys, on the camels, on the oxen, and on the sheep. There will be a very severe pestilence... So the LORD did this thing on the next day, and all the **(LIVESTOCK, BIRDS)** of Egypt died; but of the livestock of the children of Israel, not one died." EXODUS 9:3, 6
6. "So the LORD said to Moses and Aaron, 'Take for yourselves handfuls of ashes from a furnace, and let Moses scatter it toward the heavens in the sight of Pharaoh. And it will become fine dust in all the land of Egypt, and it will cause **(SOILS, BOILS)** that break out in sores on man and beast throughout all the land of Egypt.'" EXODUS 9:8-9
7. Then the LORD said, "Behold, tomorrow about this time I will cause very heavy **(HAIL, ROCKS)** to rain down, such as has not been in Egypt since its founding until now." EXODUS 9:18
8. "Then the LORD said to Moses, 'Stretch out your hand over the land of Egypt for the **(BUTTERFLIES, LOCUSTS)**, that they may come upon the land of Egypt, and eat every herb of the land - all that the hail has left.' " EXODUS 10:12
9. "Then the LORD said to Moses, 'Stretch out your hand toward heaven, that there may be **(DARKNESS, LIGHT)** over the land of Egypt.'" EXODUS 10:21

"AND THE LORD SAID TO MOSES, 'I WILL BRING YET ONE MORE PLAGUE ON PHARAOH AND ON EGYPT. AFTERWARD HE WILL LET YOU GO FROM HERE.'" EXODUS 11:1 MOSES THEN EXPLAINED TO THE ELDERS OF ISRAEL, "THE LORD WILL PASS THROUGH TO STRIKE THE EGYPTIANS; AND WHEN HE SEES THE BLOOD ON THE LINTEL AND ON THE TWO DOORPOSTS, THE LORD WILL PASS OVER THE DOOR AND NOT ALLOW THE DESTROYER TO COME INTO YOUR HOUSES TO STRIKE YOU." EXODUS. 12:23
10. "And it came to pass at midnight that the LORD struck all the **(FIRSTBORN, SECONDBORN)** in the land of Egypt, from the firstborn of Pharaoh who sat on his throne to the firstborn of the captive who was in the dungeon, and all the firstborn of livestock." EXODUS 12:29

37. THE TEN PLAGUES

(EXODUS 7:14-11:10; 12:29-30)

D	E	K	J	T	R	O	Z	J	P	U	F	B	O	F
A	S	K	T	A	I	F	S	J	J	W	I	D	F	P
R	G	Q	E	N	L	V	H	E	H	D	X	R	S	G
K	D	J	J	R	S	S	E	I	L	F	P	C	T	K
N	E	S	R	E	V	I	L	E	D	W	H	G	S	B
E	P	B	Z	P	T	N	M	A	G	Y	A	R	U	U
S	Z	B	Z	I	F	S	L	W	E	P	R	G	C	L
S	C	R	K	Q	A	V	E	C	I	L	A	N	O	N
F	N	R	O	B	T	S	R	I	F	Z	O	G	L	U
H	C	B	C	D	S	L	I	O	B	W	H	Z	L	M
A	Q	N	O	R	A	A	S	L	M	B	G	J	L	B
W	I	K	T	J	Y	M	V	Z	L	O	Y	P	M	L
L	I	V	E	S	T	O	C	K	I	M	S	N	S	O
X	W	E	I	Q	Y	A	O	X	A	W	P	E	Z	O
P	Z	F	O	S	G	O	R	F	H	U	Y	U	S	D

AARON
BLOOD
BOILS
DARKNESS

DELIVERS
FIRSTBORN
FLIES
FROGS

HAIL
LICE
LIVESTOCK

LOCUSTS
MOSES
PHARAOH

HELP MOSES GET TO PHARAOH'S THRONE

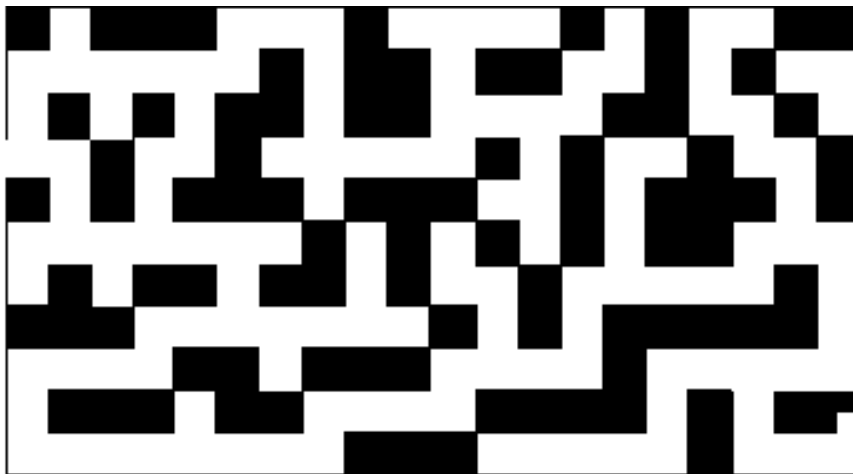

37. THE TEN PLAGUES

(EXODUS 7:14-11:10; 12:29-30)

MEMORY VERSE:

"God delivers and rescues, and He works signs and wonders in heaven and on earth."

DANIEL 6:27

FILL IN THE BLANKS:

1. "The LORD spoke to Moses, 'Say to Aaron, "Take your rod and stretch out your hand over the waters of Egypt, over their streams, over their rivers, over their ponds, and over all their pools of water, that they may become _____." ' " **EXODUS 7:19**
2. "Then the LORD spoke to Moses, 'Say to Aaron, "Stretch out your hand with your rod over the streams, over the rivers, and over the ponds, and cause _____ to come upon the land of Egypt." ' " **EXODUS 8:5**
3. "The LORD said to Moses, 'Say to Aaron, "Stretch out your rod, and strike the dust of the land, so that it may become _____ throughout all the land of Egypt." ' " **EXODUS 8:16**
4. "And the LORD said to Moses, 'Rise early in the morning and stand before Pharaoh as he comes out to the water. Then say to him, "Thus says the LORD: 'Let My people go, that they may serve Me. Or else, if you will not let My people go, behold, I will send swarms of _____ on you and your servants, on your people and into your houses.' " ' " **EXODUS 8:20-21**
5. "Again the LORD said, "Behold, the hand of the LORD will be on your cattle in the field, on the horses, on the donkeys, on the camels, on the oxen, and on the sheep. There will be a very severe pestilence... So the LORD did this thing on the next day, and all the _____ of Egypt died; but of the livestock of the children of Israel, not one died." **EXODUS 9:3, 6**
6. "So the LORD said to Moses and Aaron, 'Take for yourselves handfuls of ashes from a furnace, and let Moses scatter it toward the heavens in the sight of Pharaoh. And it will become fine dust in all the land of Egypt, and it will cause _____ that break out in sores on man and beast throughout all the land of Egypt.' " **EXODUS 9:8-9**
7. Then the LORD said, "Behold, tomorrow about this time I will cause very heavy _____ to rain down, such as has not been in Egypt since its founding until now." **EXODUS 9:18**
8. "Then the LORD said to Moses, 'Stretch out your hand over the land of Egypt for the _____, that they may come upon the land of Egypt, and eat every herb of the land - all that the hail has left.' " **EXODUS 10:12**
9. "Then the LORD said to Moses, 'Stretch out your hand toward heaven, that there may be _____ over the land of Egypt.' " **EXODUS 10:21**

"AND THE LORD SAID TO MOSES, 'I WILL BRING YET ONE MORE PLAGUE ON PHARAOH AND ON EGYPT. AFTERWARD HE WILL LET YOU GO FROM HERE.' " **EXODUS 11:1** MOSES THEN EGYPTIANS; AND WHEN HE SEES THE BLOOD ON THE LINTEL AND ON THE TWO DOORPOSTS, THE LORD WILL PASS OVER THE DOOR AND NOT ALLOW THE DESTROYER TO COME INTO YOUR HOUSES TO STRIKE YOU." **EXODUS 12:23**
10. "And it came to pass at midnight that the LORD struck all the _____ in the land of Egypt, from the firstborn of Pharaoh who sat on his throne to the firstborn of the captive who was in the dungeon, and all the firstborn of livestock." **EXODUS 12:29**

37. THE TEN PLAGUES

(EXODUS 7:14-11:10; 12:29-30)

P A N V E S J X W G X T P D H S P R G O
 K W D Q T E N X G X A C Z S S E J H K C
 J F E O G N N T L W Q N J D E Q Z G V J
 V C L N I R K E C H L L F N C P J J E A
 C Q I J T F H A Z K P O R Z I A H H L S
 Y X V H Z L P D W L U O J W L B F D O L
 Q G E W S P K E L F B Z W G D P R H C M
 O Y R D S A J M K T C Y Q Z L S K P U O
 L I S H E F G K S N W S U Y B T Y N S S
 T E R M N N S R I Q D H J T U Y S P T E
 B S F J K W I T B Y C K N R H L H W S S
 B L D R R F B B A K V R C L Q A S Q I K
 Y O O C A Q F R O G S V N O R V D A T U
 V D I O D S I D K R S I V A T O E V R V
 O E M L D D P B S H R H O U O S H U V W
 D W O Q S E U N N V A H J S J C E D I H
 U S Z F Q D C L O U Q I E K N T A V K O
 I D E Y Y U E V R P B I L U G Z R L I A
 R H L M H S U V A F L H Z P A O O Z D L
 A C L C Q N L F A F C R A T E E T N D H

AARON
 BLOOD
 BOILS
 DARKNESS

DELIVERS
 FIRSTBORN
 FLIES
 FROGS

HAIL
 LICE
 LIVESTOCK

LOCUSTS
 MOSES
 PHARAOH

HELP MOSES GET TO PHARAOH'S THRONE

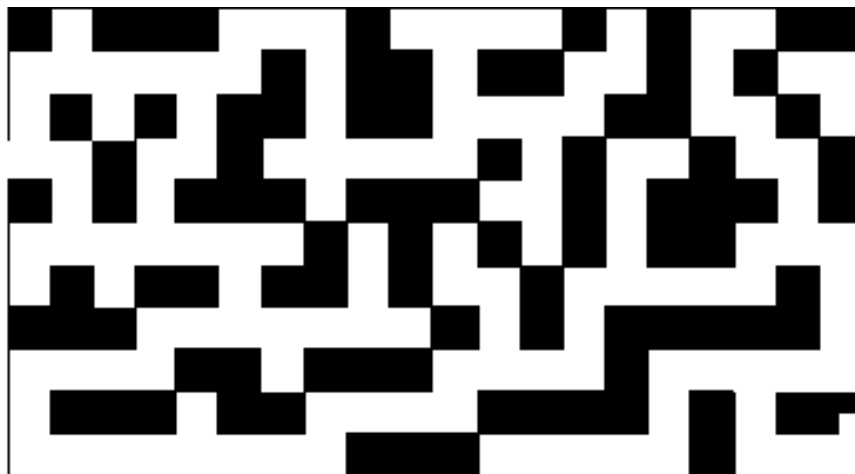

37. THE TEN PLAGUES

(EXODUS 7:14-11:10; 12:29-30)

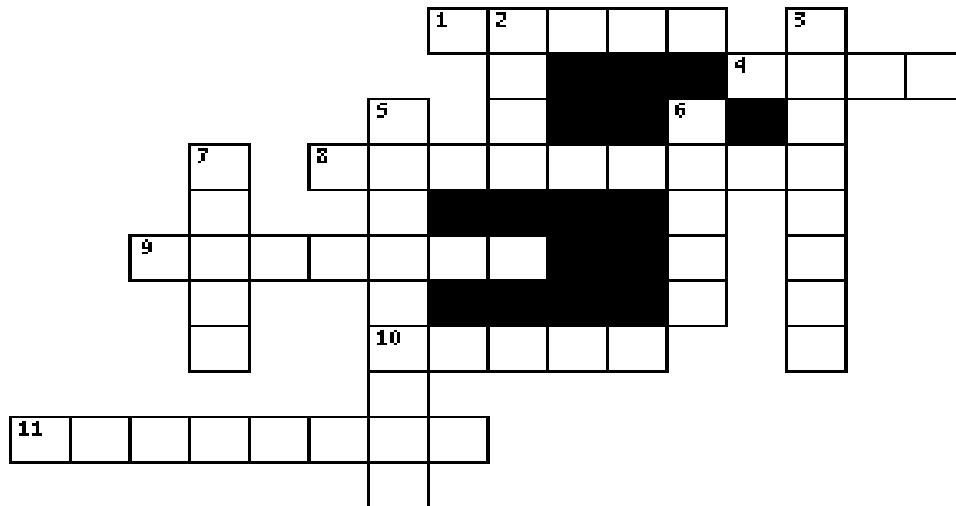

- 11 ACROSS "God _____ and rescues, and He works signs and wonders in heaven and on earth." **DANIEL 6:27**
- 10 ACROSS "The LORD spoke to Moses, 'Say to Aaron, "Take your rod and stretch out your hand over the waters of Egypt, over their streams, over their rivers, over their ponds, and over all their pools of water, that they may become _____." ' " **EXODUS 7:19**
- 7 DOWN "Then the LORD spoke to Moses, 'Say to Aaron, "Stretch out your hand with your rod over the streams, over the rivers, and over the ponds, and cause _____ to come upon the land of Egypt." ' " **EXODUS 8:5**
- 2 DOWN "The LORD said to Moses, 'Say to Aaron, "Stretch out your rod, and strike the dust of the land, so that it may become _____ throughout all the land of Egypt." ' " **EXODUS 8:16**
- 1 ACROSS "And the LORD said to Moses, 'Rise early in the morning and stand before Pharaoh as he comes out to the water. Then say to him, "Thus says the LORD: 'Let My people go, that they may serve Me. Or else, if you will not let My people go, behold, I will send swarms of _____ on you and your servants, on your people and into your houses.' " ' " **EXODUS 8:20-21**
- 8 ACROSS "Again the LORD said, "Behold, the hand of the LORD will be on your cattle in the field, on the horses, on the donkeys, on the camels, on the oxen, and on the sheep. There will be a very severe pestilence... So the LORD did this thing on the next day, and all the _____ of Egypt died; but of the livestock of the children of Israel, not one died." **EXODUS 9:3, 6**
- 6 DOWN "So the LORD said to Moses and Aaron, 'Take for yourselves handfuls of ashes from a furnace, and let Moses scatter it toward the heavens in the sight of Pharaoh. And it will become fine dust in all the land of Egypt, and it will cause _____ that break out in sores on man and beast throughout all the land of Egypt.' " **EXODUS 9:8-9**
- 4 ACROSS "Then the LORD said, "Behold, tomorrow about this time I will cause very heavy _____ to rain down, such as has not been in Egypt since its founding until now." **EXODUS 9:18**
- 9 ACROSS "Then the LORD said to Moses, 'Stretch out your hand over the land of Egypt for the _____, that they may come upon the land of Egypt, and eat every herb of the land - all that the hail has left.' " **EXODUS 10:12**
- 3 DOWN "Then the LORD said to Moses, 'Stretch out your hand toward heaven, that there may be _____ over the land of Egypt.' " **EXODUS 10:21**
- 5 DOWN "And it came to pass at midnight that the LORD struck all the _____ in the land of Egypt, from the firstborn of Pharaoh who sat on his throne to the firstborn of the captive who was in the dungeon, and all the firstborn of livestock." **EXODUS 12:29**

Bible Story 38

THE FIRST PASSOVER

EXODUS 12:1-28

38. THE FIRST PASSOVER

(EXODUS 12:1-28)



"Speak ye unto all the congregation of Israel, saying, In the tenth *day* of this month they shall take to them every man a lamb, according to the house of *their* fathers, a lamb for an house:"

EXODUS 12:3

38. THE FIRST PASSOVER

(EXODUS 12:1-28)

MEMORY VERSE:

"But now in Christ Jesus you who once were far off have been made near by the blood of Christ."
EPHESIANS 2:13

"Now the LORD spoke to Moses and Aaron in the land of Egypt, saying, 'This month shall be your beginning of months; it shall be the first month of the year to you.' " EXODUS 12:1-2

CIRCLE THE CORRECT WORDS:

1. The LORD said, "Speak to all the congregation of Israel, saying: 'On the tenth day of this month every man shall take for himself a **(LAMB, RAM)**, according to the house of his father, a **(LAMB, RAM)** for a household.' "
EXODUS 12:3

TRUE OR FALSE:

2. The LORD said, "Your lamb shall be without blemish, a male of the first year." EXODUS 12:5
TRUE OR FALSE
3. Also the LORD said to Moses, "In the first month, on the fourteenth day of the month at evening, you shall eat unleavened bread, until the twenty-first day of the month at evening." EXODUS 12:18
TRUE OR FALSE
4. "For seven days no leaven shall be found in your houses, since whoever eats what is leavened, that same person shall be cut off from the congregation of Israel, whether he is a stranger or a native of the land."
EXODUS 12:19
TRUE OR FALSE

FILL IN THE BLANKS:

5. "Then Moses called for all the elders of Israel and said to them, 'Pick out and take lambs for yourselves according to your families, and kill the _____.' " EXODUS 12:21

CIRCLE THE CORRECT WORDS:

6. Moses told them, "You shall take a bunch of hyssop, dip it in the **(WATER, BLOOD)** that is in the basin, and strike the lintel and the two doorposts with the **(WATER, BLOOD)** that is in the basin." EXODUS 12:22

TRUE OR FALSE:

7. Then Moses said to them, "For the LORD will pass through to strike the Egyptians; and when He sees the blood on the lintel and on the two doorposts, the LORD will pass over the door and not allow the destroyer to come into your houses to strike you." EXODUS 12:23
TRUE OR FALSE
8. But the children of Israel would not do those things which the LORD had commanded Moses and Aaron.
EXODUS 12:28
TRUE OR FALSE

38. THE FIRST PASSOVER

(EXODUS 12:1-28)

A N E V E S C D Y M Z P W C F
M Q W Z Q F T J O B X D R O L
X Z R C J J I Q F L R Z M G L
T M O S E S O R V L E E F R L
Y U R E V O S S A P P T A G M
L A P C B T T I L S J W N D S
B N E Q B E A L S V H B I I Z
L M S I R J N S V O G M X N L
O D E N E V A E L N U H G G F
O G G W B M A L M J E S Y Z P
D F D Z B Z R T A J U I P J G
I H E K K Z P F Z E W M Y P K
D O O R P O S T S A D E B N B
O A P K E K I A S W W L D U U
V N O R A A Q Y H L Y B R O K

AARON

DOORPOSTS

MOSES

BLEMISH

LAMB

PASSOVER

BLOOD

LINTEL

SEVEN

BREAD

LORD

UNLEAVENED

38. THE FIRST PASSOVER

(EXODUS 12:1-28)

MEMORY VERSE:

"But now in Christ Jesus you who once were far off have been made near by the blood of Christ."
EPHESIANS 2:13

"Now the LORD spoke to Moses and Aaron in the land of Egypt, saying, 'This month shall be your beginning of months; it shall be the first month of the year to you.'" EXODUS 12:1-2

FILL IN THE BLANKS:

1. The LORD said, "Speak to all the congregation of Israel, saying: 'On the tenth day of this month every man shall take for himself a _____, according to the house of his father, a _____ for a household.'" **EXODUS 12:3**
2. The LORD said, "Your lamb shall be without _____, a male of the first year." **EXODUS 12:5**

TRUE OR FALSE:

3. Also the LORD said to Moses, "In the first month, on the fourteenth day of the month at evening, you shall eat unleavened bread, until the twenty-first day of the month at evening." **EXODUS 12:18**
TRUE OR FALSE
4. "For seven days no leaven shall be found in your houses, since whoever eats what is leavened, that same person shall be cut off from the congregation of Israel, whether he is a stranger or a native of the land." **EXODUS 12:19**
TRUE OR FALSE

FILL IN THE BLANKS:

5. "Then Moses called for all the elders of Israel and said to them, 'Pick out and take lambs for yourselves according to your families, and kill the _____.'" **EXODUS 12:21**

CIRCLE THE CORRECT WORDS:

6. Moses told them, "You shall take a bunch of hyssop, dip it in the (**WATER, BLOOD**) that is in the basin, and strike the lintel and the two doorposts with the (**WATER, BLOOD**) that is in the basin." **EXODUS 12:22**

FILL IN THE BLANKS:

7. Then Moses said to them, "For the LORD will pass through to strike the Egyptians; and when He sees the blood on the _____ and on the two _____, the LORD will pass over the door and not allow the destroyer to come into your houses to strike you." **EXODUS 12:23**

TRUE OR FALSE:

8. But the children of Israel would not do those things which the LORD had commanded Moses and Aaron. **EXODUS 12:28**

TRUE OR FALSE

38. THE FIRST PASSOVER

(EXODUS 12:1-28)

U M E P R O M Y M B H S Q N Y J Z A F W
G B Y M X W F J D H A M U M F P H S L Q
I P G D O H D T W B L E M I S H K V Y N
C M R B U Q M A Q F U J Q B O G K Y H I
E O M B S N Q N E V U T T C J H R K R S
L W Q O L I L N O R A A H D L E T N I L
U N H H K L S E R I B A T W W G E W O V
X G V S W H Q A A O T A T K S R N L I U
M K V S V T V S I V T U R I D E C W R U
K B G R J Y P L T N E E R O S V V W F A
U M S V P O B P A H D N O E I O C Z Y D
Y Y O N W D Q U L I D L E P A S C O X D
Y K N S E A O T B U B N W D G S H A D W
R P B G E V J O B M A L N I W A R B F T
F U N D L S I N R A Q Q E Y A P E U B L
H Y N P V C C D Z P C R V B F D M N E A
E F O N D A T R Z F O N E B U V Q U H O
L K J S D L C A N F U S S P T B N D T A
M T Q P Z O J Z K T J A T P O G Y L L P
G G S P Z Z W E O Q K Y P S M C M U U A

AARON

DOORPOSTS

MOSES

BLEMISH

LAMB

PASSOVER

BLOOD

LINTEL

SEVEN

BREAD

LORD

UNLEAVENED

38. THE FIRST PASSOVER

(EXODUS 12:1-28)

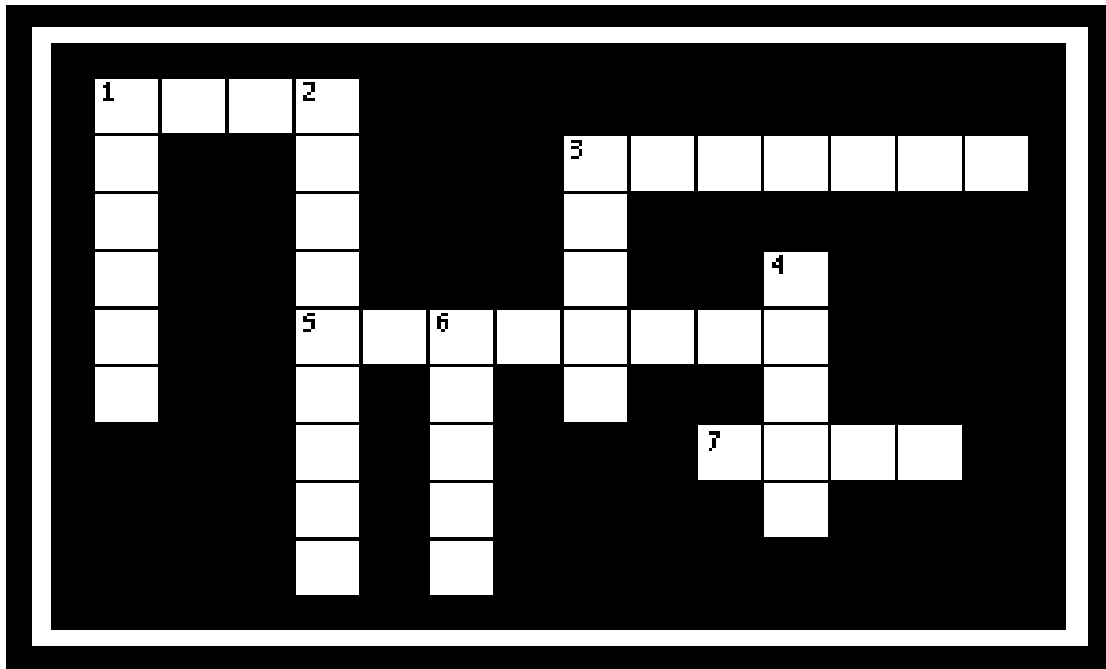

- 3 DOWN "But now in Christ Jesus you who once were far off have been made near by the ____ of Christ." **EPHESIANS 2:13**
- 7 ACROSS The LORD said, "Speak to all the congregation of Israel, saying: 'On the tenth day of this month every man shall take for himself a _____, according to the house of his father, a lamb for a household.'" **EXODUS 12:3**
- 3 ACROSS The LORD said, "Your lamb shall be without _____, a male of the first year." **EXODUS 12:5**
- 4 DOWN Also the LORD said to Moses, "In the first month, on the fourteenth day of the month at evening, you shall eat unleavened _____, until the twenty-first day of the month at evening." **EXODUS 12:18**
- 6 DOWN "For _____ days no leaven shall be found in your houses, since whoever eats what is leavened, that same person shall be cut off from the congregation of Israel, whether he is a stranger or a native of the land." **EXODUS 12:19**
- 5 ACROSS "Then Moses called for all the elders of Israel and said to them, 'Pick out and take lambs for yourselves according to your families, and kill the _____ lamb.'" **EXODUS 12:21**
- 1 DOWN Moses told them, "You shall take a bunch of hyssop, dip it in the blood that is in the basin, and strike the _____ and the two doorposts with the blood that is in the basin." **EXODUS 12:22**
- 2 DOWN Then Moses said to them, "For the LORD will pass through to strike the Egyptians; and when He sees the blood on the lintel and on the two _____ the LORD will pass over the door and not allow the destroyer to come into your houses to strike you." **EXODUS 12:23**
- 1 ACROSS "Then the children of Israel went away and did so; just as the _____ had commanded Moses and Aaron, so they did." **EXODUS 12:28**

Bible Story 39

THE EXODUS

EXODUS 12:31-51

39. THE EXODUS

(EXODUS 12:31-51)



"And the children of Israel journeyed from Rameses to Succoth,
about six hundred thousand on foot *that were* men, beside children."

EXODUS 12:37

39. THE EXODUS

(EXODUS 12:31-51)

MEMORY VERSE:

"You in Your mercy have led forth the people whom You have redeemed."

EXODUS 15:13

TRUE OR FALSE:

1. Now Pharaoh "called for Moses and Aaron by night, and said, 'Rise and go out from among my people, both you and the children of Israel. And go, serve the LORD as you have said.'"

EXODUS 12:31

TRUE OR FALSE

UNDERLINE THE CORRECT ANSWER:

2. "Now the children of Israel had done according to the word of Moses, and they had asked from the Egyptians..." **EXODUS 12:35**

- a. articles of silver
- b. articles of gold
- c. clothing
- d. all of the above

CIRCLE THE CORRECT WORD:

3. "And the LORD had given the people favor in the sight of the Egyptians, so that they granted them what they requested. Thus they (**LOVED, PLUNDERED**) the Egyptians." **EXODUS 12:36**

TRUE OR FALSE:

4. "Then the children of Israel journeyed from Rameses to Succoth, about six hundred thousand men on foot, besides children." **EXODUS 12:37**

TRUE OR FALSE

5. They brought no flocks or herds nor any livestock with them. **EXODUS 12:38**

TRUE OR FALSE

CIRCLE THE CORRECT WORDS:

6. "They baked unleavened (**CAKES, ICE CREAM**) of the dough which they had brought out of Egypt; for it was not leavened, because they were driven out of Egypt and could not wait, nor had they prepared provisions for themselves." **EXODUS 12:39**

7. "Now the sojourn of the children of Israel who lived in Egypt was four hundred and thirty (**DAYS, YEARS**)." **EXODUS 12:40**

39. THE EXODUS

(EXODUS 12:31-51)

R E D E E M E D C U S K B O D
 X V I V U W M C X D P R V V N
 F F P H U Y G P V M W O A S K
 L I Q Y I U Q L U J J I E E A
 K W F G D K W L O I H L G R Y
 I H R M L E T U D V N D Y V U
 Q I C R R I R O I E F S P E W
 S P G U T N V E C M G U T Y K
 S K O U E Y G E D A I J I X Y
 O R D Y Q H L P S N K L A C Y
 E E E V B F B D M T U E N J M
 Z D P H A R A O H N O L S N O
 P E W E E Q W Q O B E C P B S
 E N J A V X D J O A G J K L E
 U A D Z B H I J F S W T Q L S

BREAD
 CAKES
 EGYPTIANS
 JOURNEYED

LIVESTOCK
 MOSES
 MULTITUDE
 PHARAOH

PLUNDERED
 REDEEMED
 SERVE
 YEARS

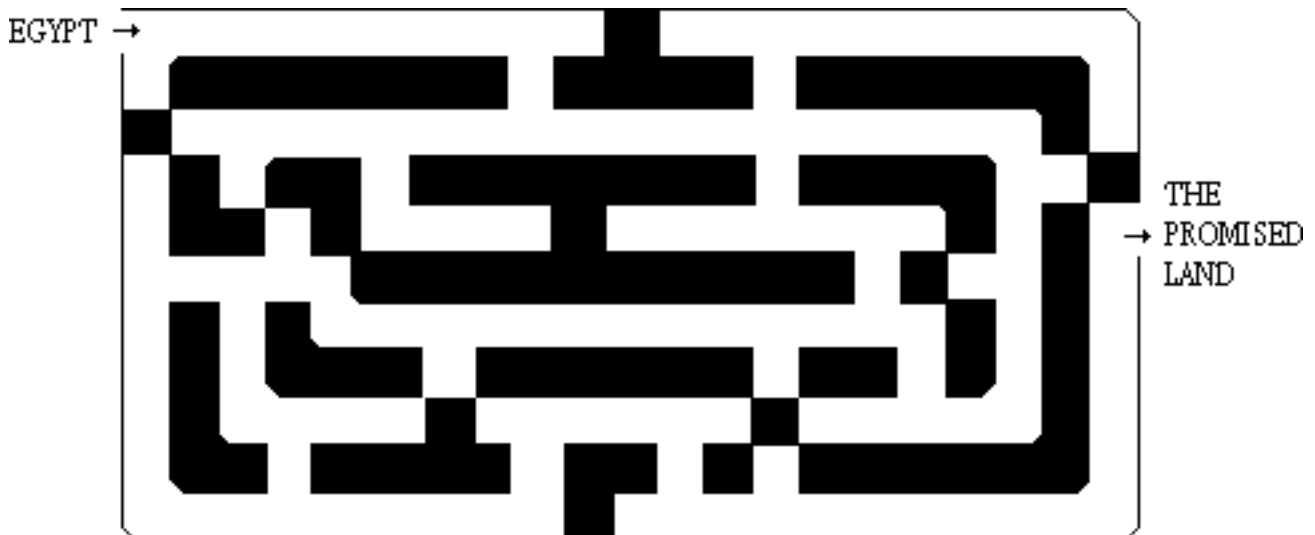

39. The Exodus

(Exodus 12:31-51)

MEMORY VERSE:

"You in Your mercy have led forth the people whom You have redeemed."

EXODUS 15:13

TRUE OR FALSE:

1. Now Pharaoh "called for Moses and Aaron by night, and said, 'Rise and go out from among my people, both you and the children of Israel. And go, serve the LORD as you have said.'
EXODUS 12:31

TRUE OR FALSE

UNDERLINE THE CORRECT ANSWER:

2. "Now the children of Israel had done according to the word of Moses, and they had asked from the Egyptians..." **EXODUS 12:35**
 - a. articles of silver
 - b. articles of gold
 - c. clothing
 - d. all of the above

FILL IN THE BLANKS:

3. "And the LORD had given the people favor in the sight of the Egyptians, so that they granted them what they requested. Thus they _____ the Egyptians." **EXODUS 12:36**

CIRCLE THE CORRECT NUMBER:

4. "Then the children of Israel journeyed from Rameses to Succoth, about (6,000 60,000 600,000) men on foot, besides children." **EXODUS 12:37**

FILL IN THE BLANKS:

5. "A mixed _____ went up with them also, and flocks and herds - a great deal of livestock". **EXODUS 12:38**
6. "They baked _____ of the dough which they had brought out of Egypt; for it was not leavened, because they were driven out of Egypt and could not wait, nor had they prepared provisions for themselves." **EXODUS 12:39**
7. "Now the sojourn of the children of Israel who lived in Egypt was four hundred and thirty _____." **EXODUS 12:40**

39. THE EXODUS

(EXODUS 12:31-51)

G Y B X Z L I U A I Q X N P S V E K H S
M G B O O O C T L U C N K Y I B N W P V
B M O S W Z M N B L I V E S T O C K O U
P Q S L P O T D Z A U A B F A R C L I U
M H H E S L C R Z F J Y C S R A E Y R A
W V S E K M U D E M E E D E R C V W F D
N V S K H A J N N F L Q D M G Z C W Y D
G G S W Q F C A D T S M W U W S C Z X W
K S R B R E A D K E M Q K L A N H O D T
B N V V I M W Z O Q R T I T F A R A F L
Y P N J L Q Y E B H J E E I U I E K B A
K B H X H J J M H A T H D T T T M U E O
P K G A T S O D F U A T P U O P Q N H A
U K D W R Q T U E V R E S D M Y N U T P
Y O P E Y A N W R U A T I E J G Y D L A
F J K L O V O Q V N U R Y O K E M L U D
K Q S V A P A H I T E R B J G H A U W Y
T S P D V B S L O T E Y B W H K S F Q S
G P P D C Q L I N D N W E S G K V L N M
E M R Z A J P T H D Q P P D D R Y Y I U

BREAD
CAKES
EGYPTIANS
JOURNEYED

LIVESTOCK
MOSES
MULTITUDE
PHARAOH

PLUNDERED
REDEEMED
SERVE
YEARS

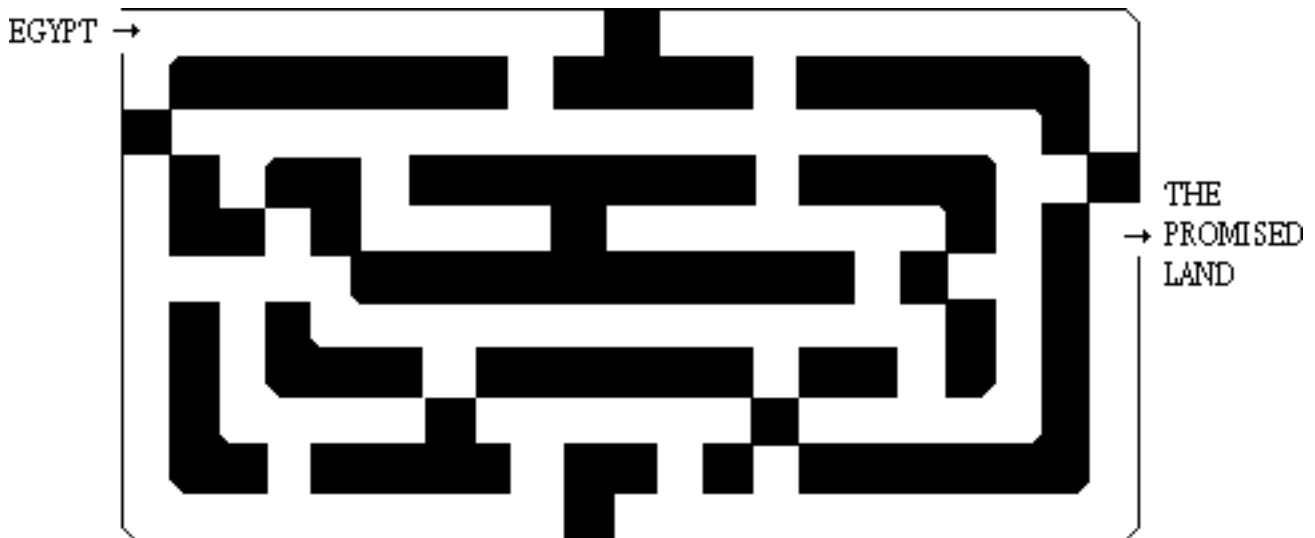

39. THE EXODUS

(EXODUS 12:31-51)

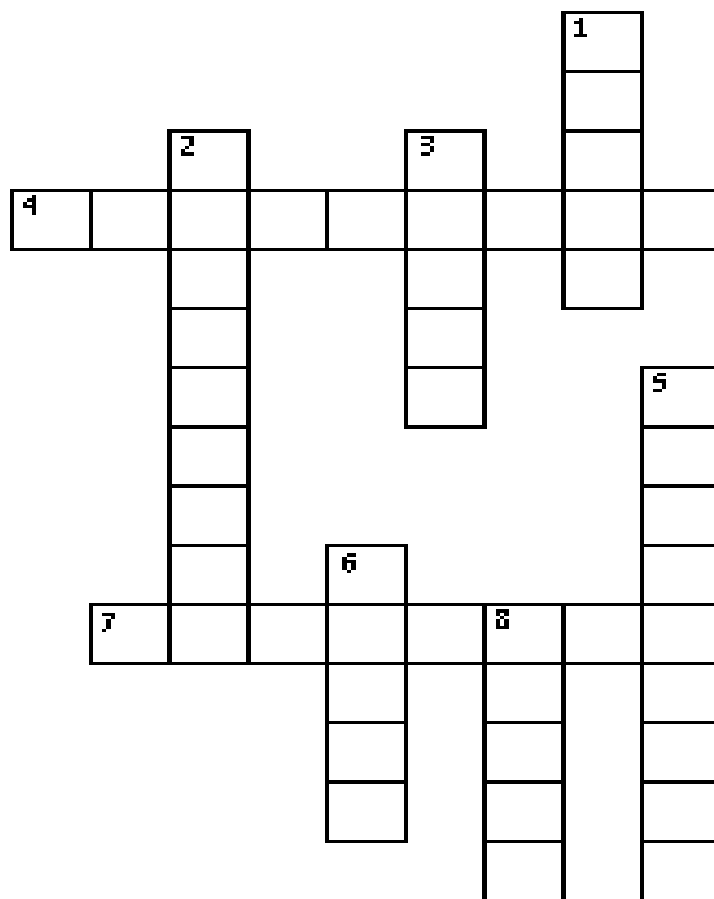

- 7 ACROSS "You in Your mercy have led forth the people whom You have r____." **EXODUS 15:13**
- 6 DOWN Now Pharaoh "called for Moses and Aaron by night, and said, 'Rise and go out from among my people, both you and the children of Israel. And go, _____ the LORD as you have said.'" **EXODUS 12:31**
- 8 DOWN "Now the children of Israel had done according to the word of _____, and they had asked from the Egyptians articles of silver, articles of gold, and clothing." **EXODUS 12:35**
- 5 DOWN "And the LORD had given the people favor in the sight of the Egyptians, so that they granted them what they requested. Thus they _____ the Egyptians." **EXODUS 12:36**
- 4 ACROSS "Then the children of Israel _____ from Rameses to Succoth, about six hundred thousand men on foot, besides children." **EXODUS 12:37**
- 2 DOWN "A mixed _____ went up with them also, and flocks and herds - a great deal of livestock". **EXODUS 12:38**
- 1 DOWN "They baked unleavened _____ of the dough which they had brought out of Egypt; for it was not leavened, because they were driven out of Egypt and could not wait, nor had they prepared provisions for themselves." **EXODUS 12:39**
- 3 DOWN "Now the sojourn of the children of Israel who lived in Egypt was four hundred and thirty _____." **EXODUS 12:40**

Bible Story 40

CROSSING THE RED SEA

EXODUS 14

40. CROSSING THE RED SEA

(EXODUS 14)



"And Moses stretched out his hand over the sea; and the LORD caused the sea to go back by a strong east wind all that night, and made the sea dry *land*, and the waters were divided."

EXODUS 14:21

40. CROSSING THE RED SEA

(EXODUS 14)

MEMORY VERSE:

"The LORD is my strength and song, and He has become my salvation." EXODUS 15:2

FILL IN THE BLANK:

1. "Now it was told the king of Egypt that the people had fled, and the _____ of Pharaoh and his servants was turned against the people; and they said, 'Why have we done this, that we let Israel go from serving us?' "
EXODUS 14:5

CIRCLE THE CORRECT WORDS:

2. "So he made ready his chariot and took his people with him. Also, he took six hundred **(RUN DOWN, CHOICE)** chariots, and all the chariots of Egypt with captains over every one of them."
EXODUS 14:6-7
3. "And when Pharaoh drew near, the children of Israel lifted their eyes, and behold, the Egyptians marched after them. So they were very **(AFRAID, EXCITED)**, and the children of Israel cried out to the LORD."
EXODUS 14:10

UNDERLINE THE CORRECT ANSWER:

4. "And Moses said to the people,..." EXODUS 14:13
a. 'Do not be afraid'
b. 'Stand still'
c. 'See the salvation of the LORD'
d. all of the above
5. "Then Moses stretched out his hand over the sea; and the LORD..." EXODUS 14:21
a. caused the sea to go back by a strong east wind all that night
b. made the sea into dry land
c. divided the waters
d. all of the above

TRUE OR FALSE:

6. "So the children of Israel went into the midst of the sea on the dry ground, and the waters were a wall to them on their right hand and on their left." EXODUS 14:22
TRUE OR FALSE
7. But the Egyptians would not pursue them for they were very afraid. EXODUS 14:23
TRUE OR FALSE
8. Then "Moses stretched out his hand over the sea; and when morning appeared, the sea returned to its full depth, while the Egyptians were fleeing into it. So the LORD overthrew the Egyptians in the midst of the sea."
EXODUS 14:27
TRUE OR FALSE

FILL IN THE BLANKS:

9. "Thus Israel saw the great work which _____ had done in Egypt; so the people feared the LORD, and believed the LORD and His servant Moses." EXODUS 14:31

40. CROSSING THE RED SEA (EXODUS 14)

C	O	E	W	R	P	S	M	C	M	Y	H	J	M	J
H	J	U	U	C	E	S	C	M	O	Y	Z	C	F	S
A	J	W	M	A	N	Z	U	L	I	O	Y	V	D	E
R	E	D	I	G	U	R	M	B	T	J	P	T	N	S
I	A	W	E	R	H	T	R	E	V	O	H	W	A	O
O	W	W	X	R	O	P	D	X	H	F	A	H	L	M
T	L	Y	G	G	F	G	L	A	E	E	R	P	Y	H
S	Z	P	Y	N	L	K	S	C	J	A	A	J	R	Q
S	N	O	I	T	A	V	L	A	S	H	O	R	D	O
H	D	Z	P	G	L	E	A	R	S	I	H	H	T	E
M	P	D	I	A	R	F	A	W	K	A	N	Q	S	W
M	J	W	Y	Z	L	B	V	J	K	L	J	O	W	E
E	G	Y	P	T	I	A	N	S	P	O	T	A	U	B
S	H	B	B	J	M	U	R	U	Z	R	P	W	D	K
V	G	M	D	A	E	S	D	E	R	D	L	V	S	S

AFRAID
CHARIOTS
DRY LAND

HEART
ISRAEL
LORD

MOSES
OVERTHREW
PHARAOH

RED SEA
SALVATION
EGYPTIANS

WRITE DOWN THE LETTERS AS YOU COME TO THEM ON THE LINES BELOW

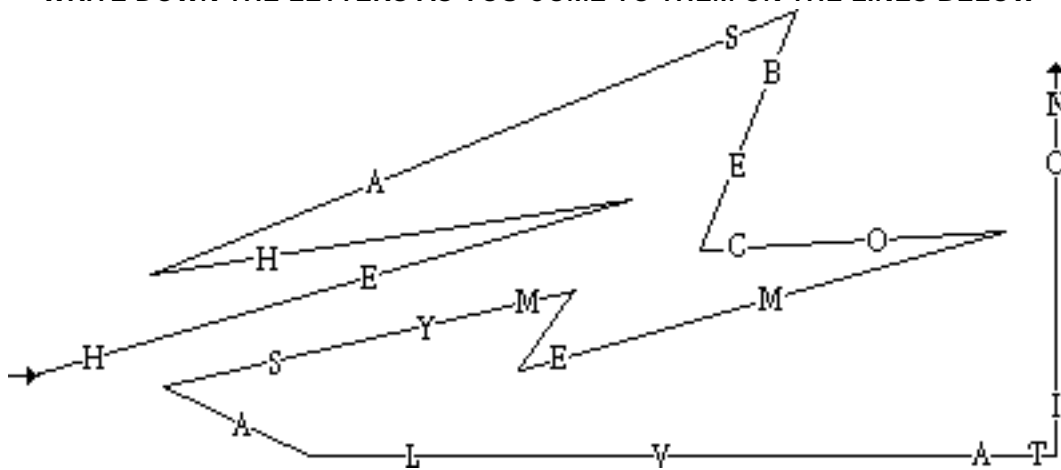

40. CROSSING THE RED SEA

(EXODUS 14)

MEMORY VERSE:

"The LORD is my strength and song, and He has become my salvation." EXODUS 15:2

FILL IN THE BLANKS:

1. "Now it was told the king of Egypt that the people had fled, and the _____ of Pharaoh and his servants was turned against the people; and they said, 'Why have we done this, that we let Israel go from serving us?' "**EXODUS 14:5**
2. "So he made ready his chariot and took his people with him. Also, he took six hundred _____ chariots, and all the chariots of Egypt with captains over every one of them." **EXODUS 14:6-7**
3. "And when Pharaoh drew near, the children of Israel lifted their eyes, and behold, the Egyptians marched after them. So they were very _____, and the children of Israel cried out to the LORD." **EXODUS 14:10**

UNDERLINE THE CORRECT ANSWER:

4. "And Moses said to the people,..." **EXODUS 14:13**
 - a. 'Do not be afraid'
 - b. 'Stand still'
 - c. 'See the salvation of the LORD'
 - d. all of the above
5. "Then Moses stretched out his hand over the sea; and the LORD..." **EXODUS 14:21**
 - a. caused the sea to go back by a strong east wind all that night
 - b. made the sea into dry land
 - c. divided the waters
 - d. all of the above

TRUE OR FALSE:

6. "So the children of Israel went into the midst of the sea on the dry ground, and the waters were a wall to them on their right hand and on their left." **EXODUS 14:22**
TRUE OR FALSE
7. But the Egyptians would not pursue them for they were very afraid. **EXODUS 14:23**
TRUE OR FALSE

FILL IN THE BLANKS:

8. Then "Moses stretched out his hand over the sea; and when morning appeared, the sea _____ to its full depth, while the Egyptians were fleeing into it. So the LORD _____ overthrew the Egyptians in the midst of the sea." **EXODUS 14:27**
9. "Thus Israel saw the great work which _____ had done in Egypt; so the people feared the LORD, and believed the LORD and His servant Moses." **EXODUS 14:31**

40. CROSSING THE RED SEA (EXODUS 14)

H	S	V	H	V	N	M	K	F	S	Q	I	I	V	R	Y	U	B	L	S
V	R	J	T	P	A	D	O	T	M	T	E	A	B	E	K	N	E	A	P
V	V	X	Y	B	S	H	B	Q	D	R	Y	L	A	N	D	U	H	O	T
G	N	L	O	S	L	W	O	H	J	H	P	G	G	N	W	D	T	A	W
S	G	W	E	Q	A	Q	H	A	T	T	I	W	A	E	S	D	E	R	B
N	D	E	A	A	P	L	H	A	R	T	Y	A	C	C	L	L	L	P	H
B	P	L	V	J	R	M	V	U	A	A	B	F	O	V	W	U	U	A	J
K	K	V	C	I	U	S	V	A	A	R	H	U	V	C	S	F	W	D	Y
K	S	D	A	H	T	I	I	U	T	R	B	P	E	C	T	L	Q	Y	K
O	P	D	L	L	E	T	I	T	U	I	P	T	R	H	O	Y	N	S	P
J	A	Z	O	C	O	A	O	T	E	W	O	O	T	R	I	H	I	M	G
Q	P	F	Z	T	E	R	R	D	N	P	P	N	H	E	R	N	S	U	L
S	R	Z	R	C	N	G	D	T	Q	N	Y	M	R	M	A	O	V	N	G
P	N	O	M	A	D	A	Y	D	X	K	M	J	E	Q	H	I	U	S	P
M	O	W	F	J	I	L	N	P	N	B	O	K	W	N	C	R	U	E	S
B	S	H	M	W	R	D	H	Q	T	C	J	G	Z	Y	W	F	A	J	O
B	L	Q	Q	Y	A	B	I	C	A	I	W	H	H	M	Z	Y	D	M	T
O	K	I	S	J	Z	Z	U	U	Y	D	A	G	K	A	O	X	D	G	W
H	M	O	S	E	S	Z	A	J	Q	W	S	N	K	S	A	D	W	O	I
S	W	L	Q	T	E	N	F	M	U	M	S	D	S	V	K	F	T	V	H

AFRAID
CHARIOTS
DRY LAND

EGYPTIANS
HEART
ISRAEL

LORD
MOSES
OVERTHREW

PHARAOH
RED SEA
SALVATION

WRITE DOWN THE LETTERS AS YOU COME TO THEM ON THE LINES BELOW

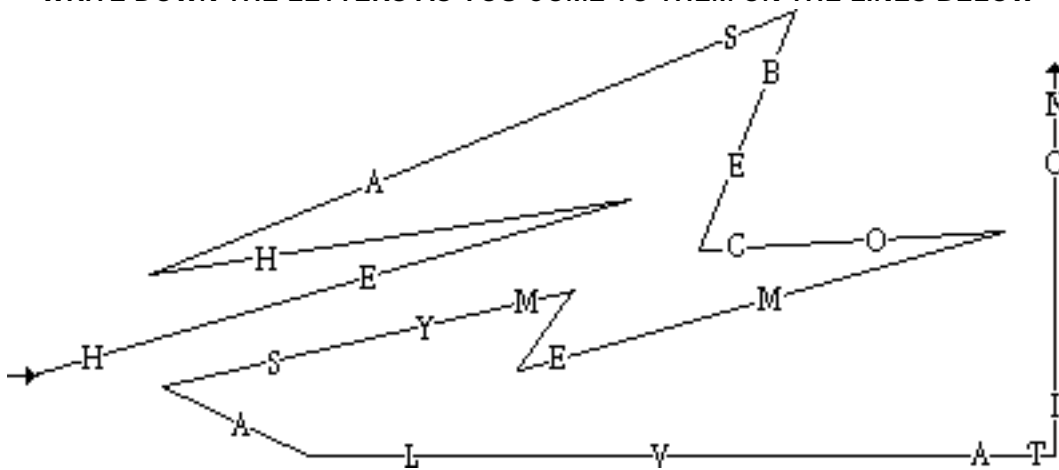

40. CROSSING THE RED SEA (EXODUS 14)

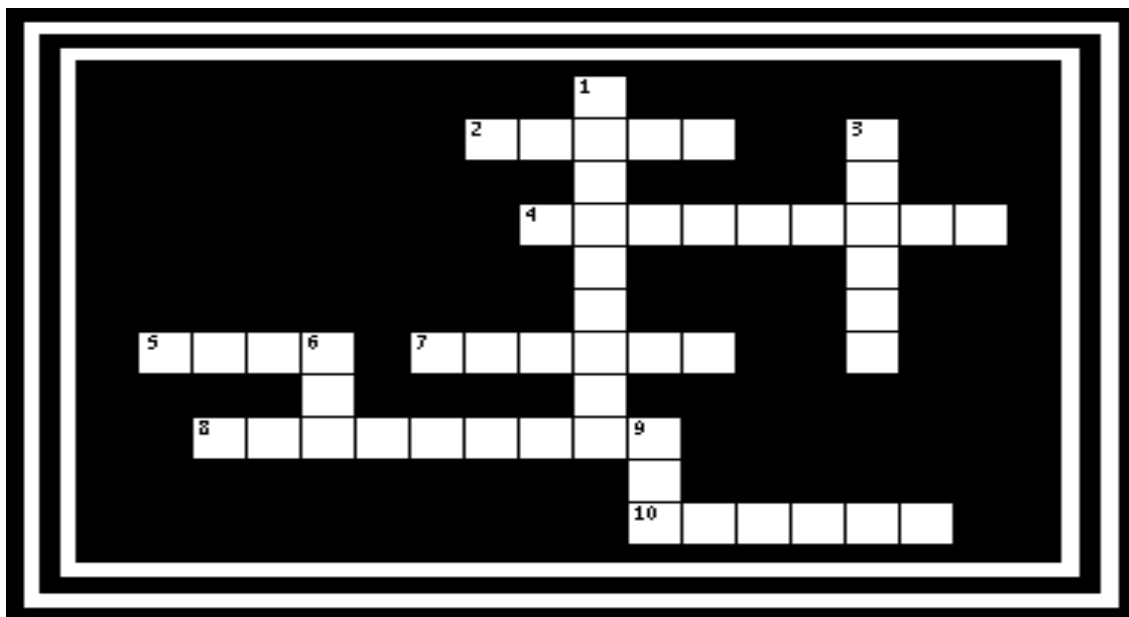

- 1 DOWN "The LORD is my strength and song, and He has become my ____." **EXODUS 15:2**
- 2 ACROSS "Now it was told the king of Egypt that the people had fled, and the ____ of Pharaoh and his servants was turned against the people; and they said, 'Why have we done this, that we let Israel go from serving us?' " **EXODUS 14:5**
- 7 ACROSS "So he made ready his chariot and took his people with him. Also, he took six hundred ____ chariots, and all the chariots of Egypt with captains over every one of them." **EXODUS 14:6-7**
- 10 ACROSS "And when Pharaoh drew near, the children of Israel lifted their eyes, and behold, the Egyptians marched after them. So they were very ____, and the children of Israel cried out to the LORD." **EXODUS 14:10**
- 5 ACROSS "And Moses said to the people, 'Do not be afraid. Stand still, and see the salvation of the ____.'" **EXODUS 14:13**
- 9 DOWN "Then Moses stretched out his hand over the sea; and the LORD caused the ____ to go back by a strong east wind all that night, and made the sea into dry land, and the waters were divided." **EXODUS 14:21**
- 6 DOWN "So the children of Israel went into the midst of the sea on the ____ ground, and the waters were a wall to them on their right hand and on their left." **EXODUS 14:22**
- 8 ACROSS "And the ____ pursued and went after them into the midst of the sea, all Pharaoh's horses, his chariots, and his horsemen." **EXODUS 14:23**
- 4 ACROSS Then "Moses stretched out his hand over the sea; and when morning appeared, the sea returned to its full depth, while the Egyptians were fleeing into it. So the LORD ____ the Egyptians in the midst of the sea." **EXODUS 14:27**
- 3 DOWN "Thus ____ saw the great work which the LORD had done in Egypt; so the people feared the LORD, and believed the LORD and His servant Moses." **EXODUS 14:31**

Bible Story 41

BREAD FROM HEAVEN

EXODUS 16:4-35

41. BREAD FROM HEAVEN

(EXODUS 16:4-35)



"And the children of Israel did eat manna forty years, until they came to a land inhabited; they did eat manna, until they came unto the borders of the land of Canaan."

EXODUS 16:35

41. BREAD FROM HEAVEN

(EXODUS 16:4-35)

MEMORY VERSE:

"For the bread of God is He who comes down from heaven and gives life to the world." JOHN 6:33

Now the children of Israel journeyed from Elim, and all the congregation came to the Wilderness of Sin... EXODUS 16:1

TRUE OR FALSE:

1. "Then the whole congregation of the children of Israel murmured against Moses and Aaron in the wilderness." EXODUS 16:2

TRUE OR FALSE

CIRCLE THE CORRECT WORDS:

2. "And the children of Israel said to them, 'Oh, that we had died by the hand of the LORD in the land of Egypt, when we sat by the pots of meat and when we ate bread to the full! For you have brought us out into this wilderness to kill this whole assembly with (THIRST, HUNGER).' " EXODUS 16:3
3. "Then the LORD said to Moses, 'Behold, I will rain bread from (HEAVEN, OVENS) for you. And the people shall go out and gather a certain quota every day.' " EXODUS 16:4

FILL IN THE BLANK:

4. "And it shall be on the _____ day that they shall prepare what they bring in, and it shall be twice as much as they gather daily." EXODUS 16:5

TRUE OR FALSE:

5. "Now it came to pass, as Aaron spoke to the whole congregation of the children of Israel, that they looked toward the wilderness, and behold, the glory of the LORD appeared in the cloud." EXODUS 16:10

TRUE OR FALSE

CIRCLE THE CORRECT WORDS:

6. "And the LORD spoke to Moses, saying, 'I have heard the (PRAISES, MURMURINGS) of the children of Israel. Speak to them, saying, "At twilight you shall eat meat, and in the morning you shall be fill with bread. And you shall know that I am the LORD your God." ' " EXODUS 16:11-12
7. "So it was that quails came up at evening and covered the camp, and in the morning the (DEW, FEATHERS) lay all around the camp." EXODUS 16:13

FILL IN THE BLANKS:

8. "And when the layer of _____ lifted, there, on the surface of the wilderness, was a small round substance, as fine as frost on the ground. So when the children of Israel saw it, they said to one another, 'What is it?' For they did not know what it was. And Moses said to them, 'This is the _____ which the LORD has given you to eat.' " EXODUS 16:14-15

CIRCLE THE CORRECT WORDS:

9. "Some of them left part of it until morning, and it bred (GRASSHOPPERS, WORMS) and stank." EXODUS 16:20
10. "And the children of Israel ate (BANANAS, MANNA) forty years, until they came to an inhabited land; they ate (MANNA, BANANAS) until they came to the border of Canaan." EXODUS 16:35

41. BREAD FROM HEAVEN

(EXODUS 16:4-35)

I S M R O W N S V S M P M B P
O G D Z K Z R T F M P W E D N
V F E K E K P F O L A Z W D U
Q M O S E S I A R V E N U R O
Z H N E V A E H T O J A N C N
U A P K N C Q Y Y J H W R A L
B W Z Q J T D Y M H T X I S L
R R C J T I J O A J G B F G I
E S G N I R U M R U M R I R M
A P C B E F I L Z E E E M G S
D E Q B E O Q F S A U G G N Z
A S I R J T R V H W W N Y G F
W I L D E R N E S S D U P Z P
N G W B Z A I M M L W H Y J G
M D U O L C L S N Z Y G O D K

BREAD

GOD

LIFE

SIXTH

CLOUD

HEAVEN

MANNA

WILDERNESS

DEW

HUNGER

MOSES

WORMS

FORTY

ISRAEL

MURMURINGS

41. BREAD FROM HEAVEN

(EXODUS 16:4-35)

MEMORY VERSE:

"For the bread of God is He who comes down from heaven and gives life to the world." JOHN 6:33

Now the children of Israel journeyed from Elim, and all the congregation came to the Wilderness of Sin... EXODUS 16:1

TRUE OR FALSE:

1. "Then the whole congregation of the children of Israel murmured against Moses and Aaron in the wilderness." EXODUS 16:2

TRUE OR FALSE

FILL IN THE BLANKS:

2. "And the children of Israel said to them, 'Oh, that we had died by the hand of the LORD in the land of Egypt, when we sat by the pots of meat and when we ate bread to the full! For you have brought us out into this wilderness to kill this whole assembly with _____.'" EXODUS 16:3
3. "Then the LORD said to Moses, 'Behold, I will rain bread from _____ for you. And the people shall go out and gather a certain quota every day.'" EXODUS 16:4
4. "And it shall be on the _____ day that they shall prepare what they bring in, and it shall be twice as much as they gather daily." EXODUS 16:5

TRUE OR FALSE:

5. "Now it came to pass, as Aaron spoke to the whole congregation of the children of Israel, that they looked toward the wilderness, and behold, the glory of the LORD appeared in the cloud." EXODUS 16:10

TRUE OR FALSE

CIRCLE THE CORRECT WORDS:

6. "And the LORD spoke to Moses, saying, 'I have heard the (**PRAISES, MURMURINGS**) of the children of Israel. Speak to them, saying, "At twilight you shall eat meat, and in the morning you shall be fill with bread. And you shall know that I am the LORD your God." ' " EXODUS 16:11-12
7. "So it was that quails came up at evening and covered the camp, and in the morning the (**DEW, FEATHERS**) lay all around the camp." EXODUS 16:13

FILL IN THE BLANKS:

8. "And when the layer of _____ lifted, there, on the surface of the wilderness, was a small round substance, as fine as frost on the ground. So when the children of Israel saw it, they said to one another, 'What is it?' For they did not know what it was. And Moses said to them, 'This is the _____ which the LORD has given you to eat.' " EXODUS 16:14-15
9. "Some of them left part of it until morning, and it bred _____ and stank." EXODUS 16:20
10. "And the house of Israel called its name _____. And it was like white coriander seed, and the taste of it was like wafers made with honey." EXODUS 16:31
11. "And the children of Israel ate manna _____ years until they came to an inhabited land; they ate manna until they came to the border of Canaan." EXODUS 16:35

41. BREAD FROM HEAVEN

(EXODUS 16:4-35)

B P V V Q L E O H A T I G G C W U E L S
K K D C J P M B A A R Y W D H W D H A P
K S D A I U R H U H E A V E N Z L T O T
O P S L W T D E U U R B A V R O U L A W
J P Z M C I W F G E W B F H T X I S P B
Q R Z O R N L V T N P P U B L E A R S I
S X O Z T O Q D T N U P T G E A F U A H
P O W M C D W I E Q N H O C M S L W D J
M S H M A N N A D R K Y M Z D G Y Q Y Y
B L Q F J Y X O D X N F J U Q N H N S K
B B I M W T I N Q N B E O H N I X I M P
O K R Q Y R T H C A C L S K Y R O S M G
H W L E J O A I U Y C O K S M U I V L K
S V H S A F L U J Q D J S K A M R U S G
S J T Q W D B A K U W W E R S R F U E P
R X Y E T R Z F S Q K L S E V U Y A J S
V W D V N D Z F M T I S O N Y M J D M O
N E O P A A O T J F I S M C W W D D G T
G A A R O N N G E H E I G V W U F W O W
D L A B S Z K Q T T P A H C L N B T V I

AARON

FORTY

ISRAEL

MURMURINGS

BREAD

GOD

LIFE

SIXTH

CLOUD

HEAVEN

MANNA

WILDERNESS

DEW

HUNGER

MOSES

WORMS

41. BREAD FROM HEAVEN

(EXODUS 16:4-35)

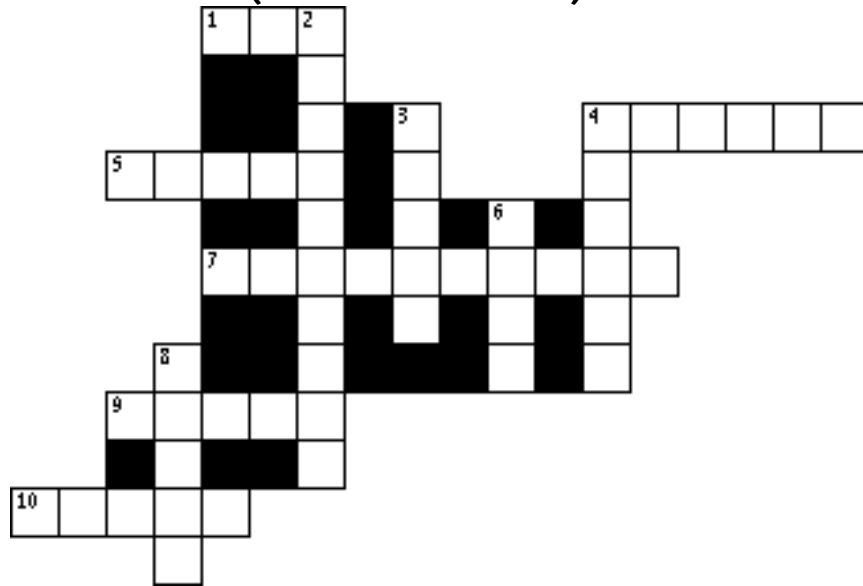

- 6 DOWN *"For the bread of God is He who comes down from heaven and gives _____ to the world."*
JOHN 6:33
- 2 DOWN "Then the whole congregation of the children of Israel murmured against Moses and Aaron in the _____."
EXODUS 16:2
- 4 DOWN "And the children of Israel said to them, 'Oh, that we had died by the hand of the LORD in the land of Egypt, when we sat by the pots of meat and when we ate bread to the full! For you have brought us out into this wilderness to kill this whole assembly with _____.'" **EXODUS 16:3**
- 4 ACROSS "Then the LORD said to Moses, 'Behold, I will rain bread from _____ for you. And the people shall go out and gather a certain quota every day.'" **EXODUS 16:4**
- 10 ACROSS "And it shall be on the _____ day that they shall prepare what they bring in, and it shall be twice as much as they gather daily." **EXODUS 16:5**
- 3 DOWN "Now it came to pass, as Aaron spoke to the whole congregation of the children of Israel, that they looked toward the wilderness, and behold, the glory of the LORD appeared in the _____." **EXODUS 16:10**
- 7 ACROSS "And the LORD spoke to Moses, saying, 'I have heard the _____ of the children of Israel. Speak to them, saying, 'At twilight you shall eat meat, and in the morning you shall be fill with bread. And you shall know that I am the LORD your God.'" " **EXODUS 16:11-12**
- 1 ACROSS "So it was that quails came up at evening and covered the camp, and in the morning the _____ lay all around the camp." **EXODUS 16:13**
- 5 ACROSS "And when the layer of dew lifted, there, on the surface of the wilderness, was a small round substance, as fine as frost on the ground. So when the children of Israel saw it, they said to one another, 'What is it?' For they did not know what it was. And Moses said to them, 'This is the _____ which the LORD has given you to eat.'" **EXODUS 16:14-15**
- 9 ACROSS "Some of them left part of it until morning, and it bred _____ and stank." **EXODUS 16:20**
- 8 DOWN "And the children of Israel ate manna _____ years, until they came to an inhabited land; they ate manna until they came to the border of Canaan." **EXODUS 16:35**

Bible Story 42

WATER FROM THE ROCK

EXODUS 17:1-6

42. WATER FROM THE ROCK (EXODUS 17:1-6)



"Behold, I will stand before thee there upon the rock in Horeb; and thou shalt smite the rock, and there shall come water out of it, that the people may drink. And Moses did so in the sight of the elders of Israel."

EXODUS 17:6

42. WATER FROM THE ROCK (EXODUS 17:1-6)

MEMORY VERSE:

"Tremble, O earth, at the presence of the LORD, at the presence of the God of Jacob, who turned the rock into a pool of water." PSALM 114:7-8

Now "all the congregation of the children of Israel set out on their journey from the Wilderness of Sin, according to the commandment of the LORD, and camped in Rephidim..." EXODUS 17:1

TRUE OR FALSE:

1. There was plenty of water for the people to drink. EXODUS 17:1
TRUE OR FALSE

CIRCLE THE CORRECT WORDS:

2. "Therefore the people contended with Moses, and said, 'Give us (WATER, SODA), that we may drink.'" EXODUS 17:2
3. "And Moses said to them, 'Why do you contend with me? Why do you (FEAR, TEMPT) the LORD?'" EXODUS 17:2

TRUE OR FALSE:

4. "And the people thirsted there for water, and the people murmured against Moses." EXODUS 17:3
TRUE OR FALSE
5. So Moses cried out to the LORD, saying, "What shall I do with this people? They are almost ready to make me a king!" EXODUS 17:4
TRUE OR FALSE
6. "And the LORD said to Moses, 'Go on before the people, and take with you some of the elders of Israel. Also take in your hand your rod with which you struck the river, and go.'" EXODUS 17:5
TRUE OR FALSE

FILL IN THE BLANK:

7. And the LORD said to Moses, "Behold, I will stand before you there on the rock in Horeb; and you shall _____ the rock, and water will come out of it, that the people may drink." EXODUS 17:6

TRUE OR FALSE:

8. "And Moses did so in the sight of the elders of Israel." EXODUS 17:6
TRUE OR FALSE

42. WATER FROM THE ROCK (EXODUS 17:1-6)

C	K	N	I	R	D	L	F	I	L	T	V	X	I	E
U	W	R	Q	S	E	D	H	H	S	B	Q	P	W	F
Q	P	J	I	S	O	R	N	O	R	T	Z	E	Z	J
D	P	S	K	I	O	E	G	R	N	E	O	S	K	T
M	W	T	P	M	E	T	X	E	V	I	T	N	K	E
C	O	T	T	D	C	L	G	B	Q	A	U	A	E	J
L	Q	S	O	L	F	W	M	V	T	M	A	G	W	Z
O	T	R	E	S	K	J	R	U	A	X	N	D	Q	Z
R	D	E	T	S	R	I	H	T	R	T	M	E	J	K
D	A	A	D	J	B	N	Q	V	Q	M	G	P	B	C
N	U	Z	Y	F	Y	S	I	B	F	Y	U	Z	B	T
W	U	S	H	F	N	Z	P	Q	H	K	F	R	R	I
S	T	R	I	K	E	K	H	Y	C	L	H	C	E	O
T	H	D	U	O	M	B	Z	O	P	I	A	C	B	D
I	E	J	Q	P	H	Z	R	E	J	O	W	Q	K	T

DRINK
HOREB
LORD
MOSES

MURMURED
ROD
ROCK
STONE

STRIKE
TEMPT
THIRSTED
WATER

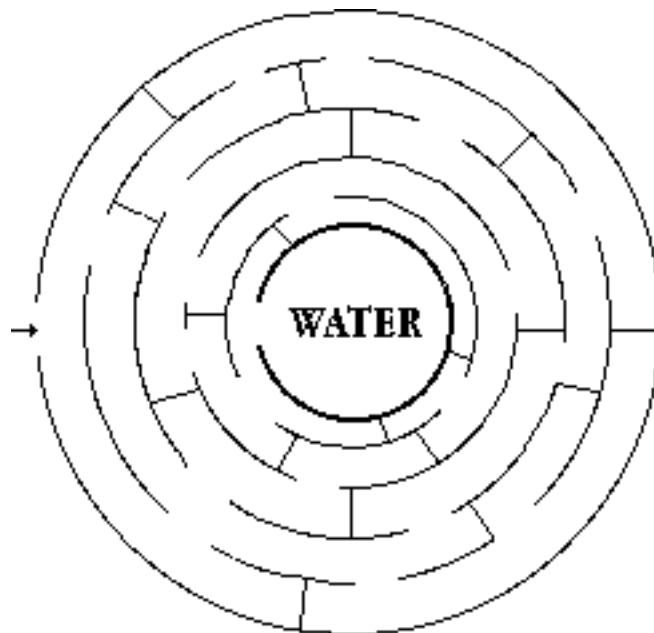

"Tremble, O earth, at the presence of the LORD, at the presence of the God of Jacob, who turned the rock into a pool of water."

PSALM 114:7-8

42. WATER FROM THE ROCK (EXODUS 17:1-6)

MEMORY VERSE:

"Tremble, O earth, at the presence of the LORD, at the presence of the God of Jacob, who turned the rock into a pool of water." PSALM 114:7-8

Now "all the congregation of the children of Israel set out on their journey from the Wilderness of Sin, according to the commandment of the LORD, and camped in Rephidim..." EXODUS 17:1

TRUE OR FALSE:

1. There was plenty of water for the people to drink. **EXODUS 17:1**
TRUE OR FALSE

FILL IN THE BLANKS:

2. "Therefore the people contended with Moses, and said, 'Give us _____, that we may drink.' " **EXODUS 17:2**
3. "And Moses said to them, 'Why do you contend with me? Why do you _____ the LORD?' " **EXODUS 17:2**

TRUE OR FALSE:

4. "And the people thirsted there for water, and the people murmured against Moses." **EXODUS 17:3**
TRUE OR FALSE
5. So Moses cried out to the LORD, saying, "What shall I do with this people? They are almost ready to make me a king!" **EXODUS 17:4**
TRUE OR FALSE

FILL IN THE BLANKS:

6. "And the LORD said to Moses, 'Go on before the people, and take with you some of the elders of Israel. Also take in your hand your _____ with which you struck the river, and go.' " **EXODUS 17:5**
7. And the LORD said to Moses, "Behold, I will stand before you there on the rock in Horeb; and you shall _____ the rock, and water will come out of it, that the people may drink." **EXODUS 17:6**

TRUE OR FALSE:

8. "And Moses did so in the sight of the elders of Israel." **EXODUS 17:6**
TRUE OR FALSE

42. WATER FROM THE ROCK

(EXODUS 17:1-6)

U B Y M X W F J W V U A T K J G C W R U
 G P G B O H M T Q I T A T I W D V W F A
 I M M D S Q K N X T E M P T S V C Z Y D
 C W O B T I Q N I O T U R E S B C O X D
 E R Q O L H S A I N D E R P I G H A D W
 U N H H K L I S T R D N W I R E T A W T
 X G V S W H Q R A H D Q P E A C R K F L
 M K V S V T V L S I Q X N L G E E U B A
 K B G R J Y P P L T C N K D B K M N E O
 U Y S V X O B U B U E A B E W I Q U H A
 Y S N N W A Q T Z A U D R R A R N D T P
 Y K T G E M J N Z F J O C S F T Y L L A
 R P B O L V U D N F H Y D Y U S M U U D
 F M K D N C I R K C O R S B T Z A F W Y
 H Y K P V E C R M T K Q E B O H S L Q S
 E F O K D A T A K U S U S P M K V Y N M
 L K J S D L C Z O Q R Q O P J K Y H I U
 M T Q P Z O J E B H M E M Y K R K L S B
 G G S P Z Z W M H A J T D F G E W O V S
 M E P R O M Y D F U T H W O H N L I U E

DRINK
 ELDERS
 HOREB
 MOSES

MURMURED
 ROCK
 ROD
 STONE

STRIKE
 TEMPT
 THIRSTED
 WATER

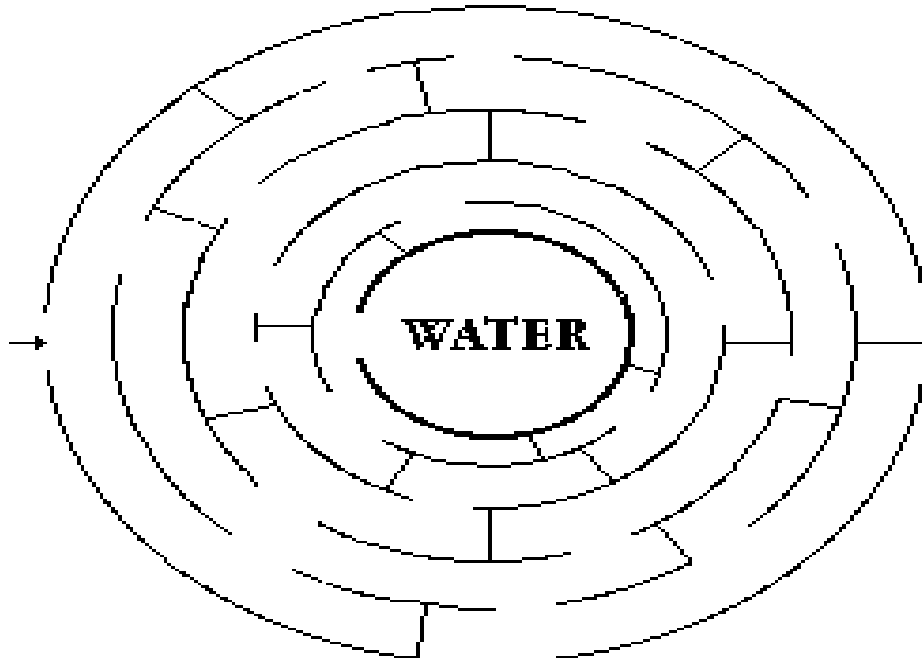

"Tremble, O earth, at the presence of the LORD, at the presence of the God of Jacob, who turned the rock into a pool of water."

PSALM 114:7-8

42. WATER FROM THE ROCK (EXODUS 17:1-6)

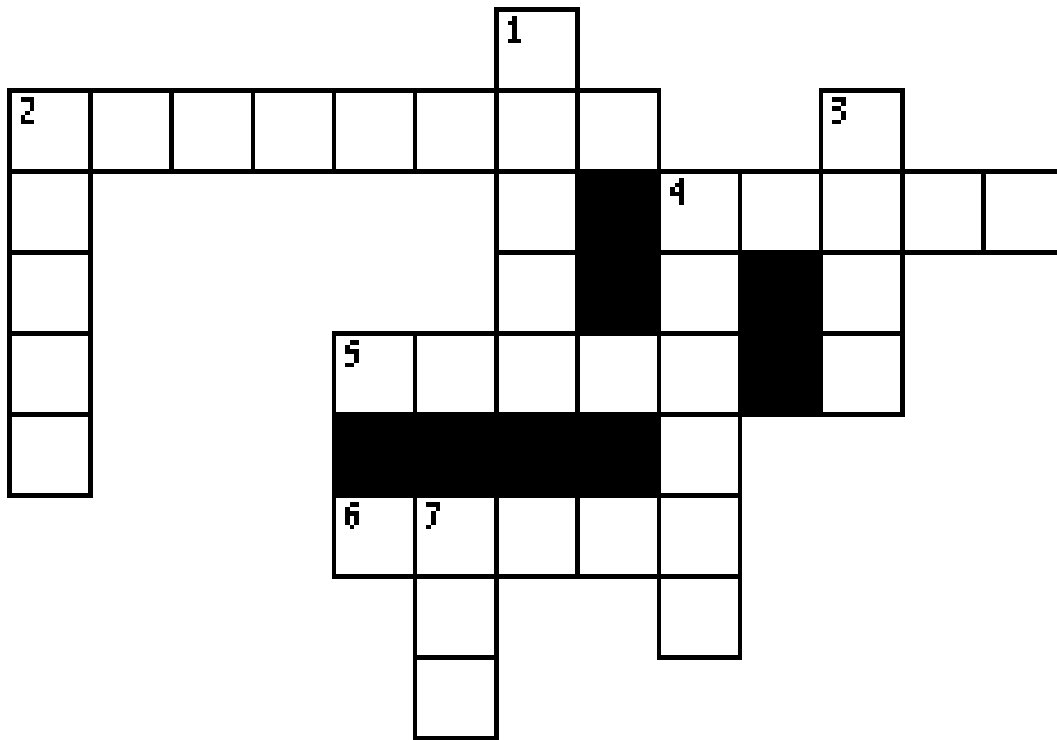

- 3 DOWN "Tremble, O earth, at the presence of the LORD, at the presence of the God of Jacob, who turned the _____ into a pool of water." **PSALM 114:7-8**
- 6 ACROSS "There was no water for the people to _____." **EXODUS 17:1**
- 5 ACROSS "Therefore the people contended with Moses, and said, 'Give us _____, that we may drink.'" **EXODUS 17:2**
- 1 DOWN "And Moses said to them, 'Why do you contend with me? Why do you _____ the LORD?'" **EXODUS 17:2**
- 2 ACROSS "And the people thirsted there for water, and the people _____ against Moses." **EXODUS 17:3**
- 4 ACROSS "So Moses cried out to the LORD, saying, 'What shall I do with this people? They are almost ready to _____ me!'" **EXODUS 17:4**
- 7 DOWN "And the LORD said to Moses, 'Go on before the people, and take with you some of the elders of Israel. Also take in your hand your _____ with which you struck the river, and go.'" **EXODUS 17:5**
- 4 DOWN And the LORD said to Moses, "Behold, I will stand before you there on the rock in Horeb; and you shall _____ the rock, and water will come out of it, that the people may drink." **EXODUS 17:6**
- 2 DOWN "And _____ did so in the sight of the elders of Israel." **EXODUS 17:6**

Bible Story 43

**THE TEN
COMMANDMENTS**

EXODUS 19:20-20:17

43. THE TEN COMMANDMENTS (EXODUS 19:20-20:17)



"And he gave unto Moses, when he had made an end of communing with him upon mount Sinai, two tables of testimony, tables of stone, written with the finger of God."

EXODUS 31:18

43. THE TEN COMMANDMENTS

(EXODUS 19:20-20:17)

MEMORY VERSE:

"And you shall love the LORD your God with all your heart, with all your soul, with all your mind and with all your strength... You shall love your neighbor as yourself." MARK 12:30-31

"And God spoke all these words, saying: I am the LORD your God, who brought you out of the land of Egypt, out of the house of bondage." EXODUS 20:1-2

TRUE OR FALSE:

1. "You shall have no other gods before Me." **EXODUS 20:3**
TRUE OR FALSE
2. "You shall not make for yourself any carved image, or any likeness of anything that is in heaven above, or that is in the earth beneath, or that is in the water under the earth; you shall not bow down to them nor serve them." **EXODUS 20:4-5**
TRUE OR FALSE
3. "You shall not take the name of the LORD your God in vain, for the LORD will not hold him guiltless who takes His name in vain." **EXODUS 20:7**
TRUE OR FALSE
4. "Remember the Sabbath day, to keep it holy. Six days you shall labor and do all your work, but the seventh day is the Sabbath of the LORD your God." **EXODUS 20:8-10**
TRUE OR FALSE
5. "Dishonor your father and your mother, that your days may be long upon the land which the LORD your God is giving you." **EXODUS 20:12**
TRUE OR FALSE
6. "You shall not murder." **EXODUS 20:13**
TRUE OR FALSE
7. "You shall not commit adultery." **EXODUS 20:14**
TRUE OR FALSE
8. "You shall steal." **EXODUS 20:15**
TRUE OR FALSE
9. "You shall bear false witness against your neighbor." **EXODUS 20:16**
TRUE OR FALSE
10. "You shall not covet your neighbor's house; you shall not covet your neighbor's wife, nor his manservant, nor his maidservant, nor his ox, nor his donkey, nor anything that is your neighbor's." **EXODUS 20:17**
TRUE OR FALSE

"AND WHEN HE HAD MADE AN END OF SPEAKING WITH HIM ON MOUNT SINAI, HE GAVE MOSES TWO TABLETS OF THE TESTIMONY, TABLETS OF STONE, WRITTEN WITH THE FINGER OF GOD." **EXODUS 31:18**

43. THE TEN COMMANDMENTS

(EXODUS 19:20-20:22)

N H V Q T M G Z E I Q Y L J X
 E N B F Y G D K F O R Y S J P
 I G Q H L F E K J T I O V H J
 G X Y P I H T R A E H M M T H
 H G F L E S R U O Y L O A G G
 B R E J O A P Q T A S S N N E
 O Q L T V W Z J E N T E Z E U
 R I N B Q X C B J R T S S R W
 S S T N E M D N A M M O C T D
 Z P V I Z D O G Z P F L H S W
 K H D N I M C B Z I A U M E L
 B Z Q A U P Q R K Q E O M A O
 M O U N T S I N A I V S S W R
 Z I T M A E I B C D O F V L D
 F V A X N S W K T J L V O Z Y

COMMANDMENTS

GOD
 HEART
 LORD
 LOVE

MIND
 MOSES
 MOUNT SINAI
 NEIGHBOR

SOUL
 STRENGTH
 TEN
 YOURSELF

WRITE DOWN THE LETTERS IN THE BOXES AS YOU COME TO THEM ON THE LINES BELOW

I II III IV V
 VI VII VIII IX X

L [] [] [] [] A [] [] [] [] [] []
 [] V [] [] [] [] [] N [] [] E [] []
 [] [] [] O [] [] [] [] [] [] H []
 E [] [] [] [] [] [] [] R [] [] [] []
 [] [] O [] [] E [] N [] [] O [] [] []
 [] [] [] [] [] [] [] [] [] T [] []

"-----"

43. THE TEN COMMANDMENTS

(EXODUS 19:20-20:17)

MEMORY VERSE:

"And you shall love the LORD your God with all your heart, with all your soul, with all your mind and with all your strength... You shall love your neighbor as yourself." MARK 12:30-31

"And God spoke all these words, saying: I am the LORD your God, who brought you out of the land of Egypt, out of the house of bondage." EXODUS 20:1-2

FILL IN THE BLANKS:

1. "You shall have _____ other gods before Me." **EXODUS 20:3**
2. "You shall not make for yourself any carved _____, or any likeness of anything that is in heaven above, or that is in the earth beneath, or that is in the water under the earth; you shall not bow down to them nor serve them." **EXODUS 20:4-5**
3. "You shall not take the _____ of the LORD your God in vain, for the LORD will not hold him guiltless who takes His name in vain." **EXODUS 20:7**
4. "Remember the _____ day, to keep it holy. Six days you shall labor and do all your work, but the seventh day is the Sabbath of the LORD your God." **EXODUS 20:8-10**
5. "_____ your father and your mother, that your days may be long upon the land which the LORD your God is giving you." **EXODUS 20:12**
6. "You shall not _____." **EXODUS 20:13**
7. "You shall not commit _____." **EXODUS 20:14**
8. "You shall not _____." **EXODUS 20:15**
9. "You shall not bear false _____ against your neighbor." **EXODUS 20:16**
10. "You shall not _____ your neighbor's house; you shall not covet your neighbor's wife, nor his manservant, nor his maidservant, nor his ox, nor his donkey, nor anything that is your neighbor's." **EXODUS 20:17**

CIRCLE THE CORRECT WORDS:

11. "And Moses said to the people, 'Do not fear; for God has come to (**ARREST**, **TEST**) you, and that His fear may be before you, so that you may not sin.' " **EXODUS 20:20**
12. "Then the LORD said to Moses, 'Thus you shall say to the children of Israel: "You have seen that I have talked with you from (**HEAVEN**, **EARTH**). " ' " **EXODUS 20:22**
13. "And when He had made an end of speaking with him on Mount Sinai, He gave Moses two (**ASPIRINS**, **TABLETS**) of the Testimony, tablets of stone, written with the finger of God." **EXODUS 31:18**

43. THE TEN COMMANDMENTS

(EXODUS 19:20-20:22)

D S P G X Q M B D N U Z V F G X T K F L
 V J C Q E Q I Z F S P I N B P P O P O P
 A F P C K H O F A H W I P L C R J R L K
 I P Q F Y F X W B U S D Y A V E D Z K R
 Z K X C B O K H T G N E R T S M L S I E
 P A V J Z I E M T S C M S E U H O T Q N
 M R L K U S Y Y E Y O Z G O I Y V V S A
 E K I T F H T L N U P P N Z M Y E G S I
 O H J R J H T N N J R Z M I N D N W O P
 G I C A U Q E T E N F V W C P E Q D E Q
 E T J E L U S N R M M U Y L I M L K Z F
 X J H H K I Z D M D D D Z G N B P A P R
 F H L V N F Q L E Y E N H W S P V G E C
 J B Q A B U V C U I T B A C C R G S U G
 M C I O D M L V W O O W U M N Y Y A V O
 D G H B C N S O G R S E G A M R Q U F W
 E O Y Y Z V F L E S R U O Y P O D L I J
 H H G D R S R S F B L E F Z C E C S U V
 E G O G D L S K Z L M B Y S M M O Y H H
 I Q F C Y B B L A O E D I D C V O X I Y

COMMANDMENTS
 GOD
 HEART
 LORD
 LOVE

MIND
 MOSES
 MOUNT SINAI
 NEIGHBOR

SOUL
 STRENGTH
 TEN
 YOURSELF

WRITE DOWN THE LETTERS IN THE BOXES AS YOU COME TO THEM ON THE LINES BELOW

"-----"

43. THE TEN COMMANDMENTS

(EXODUS 19:20-20:17)

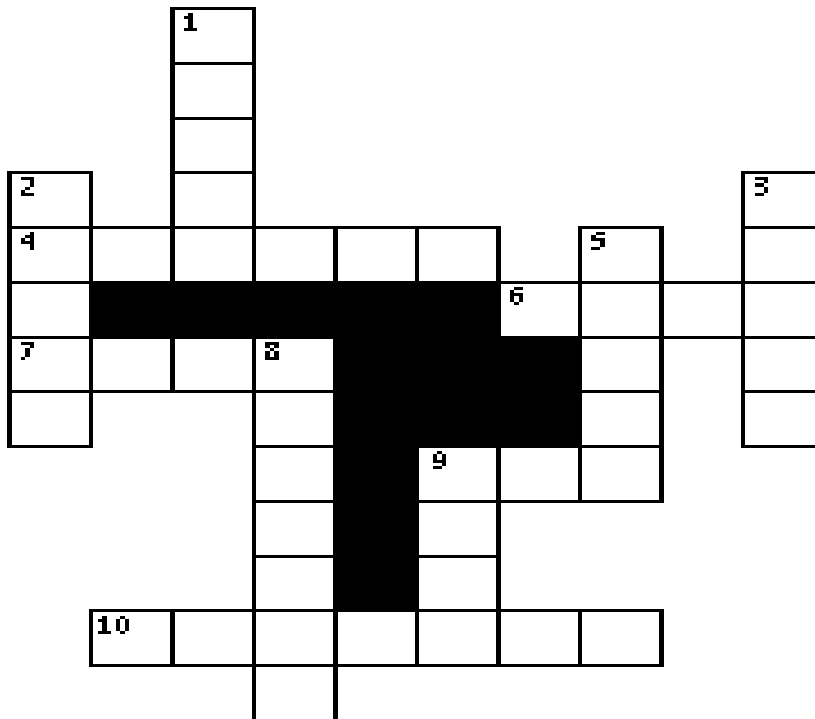

- 6 ACROSS "And you shall ____ the LORD your God with all your heart, with all your soul, with all your mind and with all your strength...You shall love your neighbor as yourself." **MARK 12:30-31**
- 7 ACROSS "You shall have no other ____ before Me." **EXODUS 20:3**
- 2 DOWN "You shall not make for yourself any carved ____, or any likeness of anything that is in heaven above, or that is in the earth beneath, or that is in the water under the earth; you shall not bow down to them nor serve them." **EXODUS 20:4-5**
- 9 DOWN "You shall not take the ____ of the LORD your God in vain, for the LORD will not hold him guiltless who takes His name in vain." **EXODUS 20:7**
- 8 DOWN "Remember the ____ day, to keep it holy. Six days you shall labor and do all your work, but the seventh day is the Sabbath of the LORD your God." **EXODUS 20:8-10**
- 1 DOWN "____ your father and your mother, that your days may be long upon the land which the LORD your God is giving you." **EXODUS 20:12**
- 4 ACROSS "You shall not ____." **EXODUS 20:13**
- 9 ACROSS "You shall ____ commit adultery." **EXODUS 20:14**
- 3 DOWN "You shall not ____." **EXODUS 20:15**
- 10 ACROSS "You shall not bear false ____ against your neighbor." **EXODUS 20:16**
- 5 DOWN "You shall not ____ your neighbor's house; you shall not covet your neighbor's wife, nor his manservant, nor his maidservant, nor his ox, nor his donkey, nor anything that is your neighbor's." **EXODUS 20:17**

Bible Story 44

THE GOLDEN CALF

EXODUS 32

44. THE GOLDEN CALF

(EXODUS 32)



"And he received the gold from their hand, and he fashioned it with an engraving tool, and made a molded calf."

EXODUS 32:4

44. THE GOLDEN CALF

(EXODUS 32)

MEMORY VERSE:

"For it is written, 'You shall worship the LORD your God, and Him only you shall serve.' " MATTHEW 4:10

FILL IN THE BLANKS:

1. "Now when the people saw that Moses delayed coming down from the mountain, the people gathered together to Aaron, and said to him, 'Come, _____ that shall go before us; for as for this Moses, the man who brought us up out of the land of Egypt, we do not know what has become of him.' " **EXODUS 32:1**

TRUE OR FALSE:

2. "And Aaron said to them, 'Break off the golden earrings which are in the ears of your wives, your sons,, and your daughters, and bring them to me.' " **EXODUS 32:2**

TRUE OR FALSE

CIRCLE THE CORRECT WORD:

3. "And he received the gold from their hand, and he fashioned it with an engraving tool, and made a molded (**ELEPHANT, CALF**)." **EXODUS 32:4**

TRUE OR FALSE:

4. "And the LORD said to Moses, 'Go, get down! For your people whom you brought out of the land of Egypt have corrupted themselves.' " **EXODUS 32:7**

TRUE OR FALSE

CIRCLE THE CORRECT WORD:

5. "So it was, as soon as he came near the camp, that he saw the calf and the dancing. So Moses' anger became hot, and he cast the (**TABLETS, PEOPLE**) out of his hands and broke them at the foot of the mountain." **EXODUS 32:19**

UNDERLINE THE CORRECT ANSWER:

6. "Then he took the calf which they had made..." **EXODUS 32:20**
 - a. burned it in the fire
 - b. ground it to powder
 - c. scattered it on the water
 - d. made the children of Israel drink it
 - e. all of the above

CIRCLE THE CORRECT WORDS:

7. "And it came to pass on the next day that Moses said to the people, 'You have sinned a (**GREAT, LITTLE**) sin. So now I will go up to the LORD; perhaps I can make atonement for your sin.' " **EXODUS 32:30**
8. The LORD said to Moses, "Now therefore, go, lead the people to the place of which I have spoken to you. Behold, My Angel (**SHALL, SHALL NOT**) go before you. Nevertheless, in the day when I visit for punishment, I will visit punishment upon them for their sin." **EXODUS 32:34**
9. "So the LORD (**FORGOT, PLAGUED**) the people because of what they did with the calf which Aaron made." **EXODUS 32:35**

44. THE GOLDEN CALF

(EXODUS 32)

M O S E S P Y A D P
S D U T C A L F R L
V P I H S R O W I A
R A K E K Z O H N G
C C G O L D J A K U
D E T P U R R O C E
M D E N N I S H N D
L W O J K Y F Z J L
T A B L E T S Y T J
B J I N O R A A P C

AARON
CALF
CORRUPTED
DRINK

GOLD
MOSES
PLAGUED

SINNED
TABLETS
WORSHIP

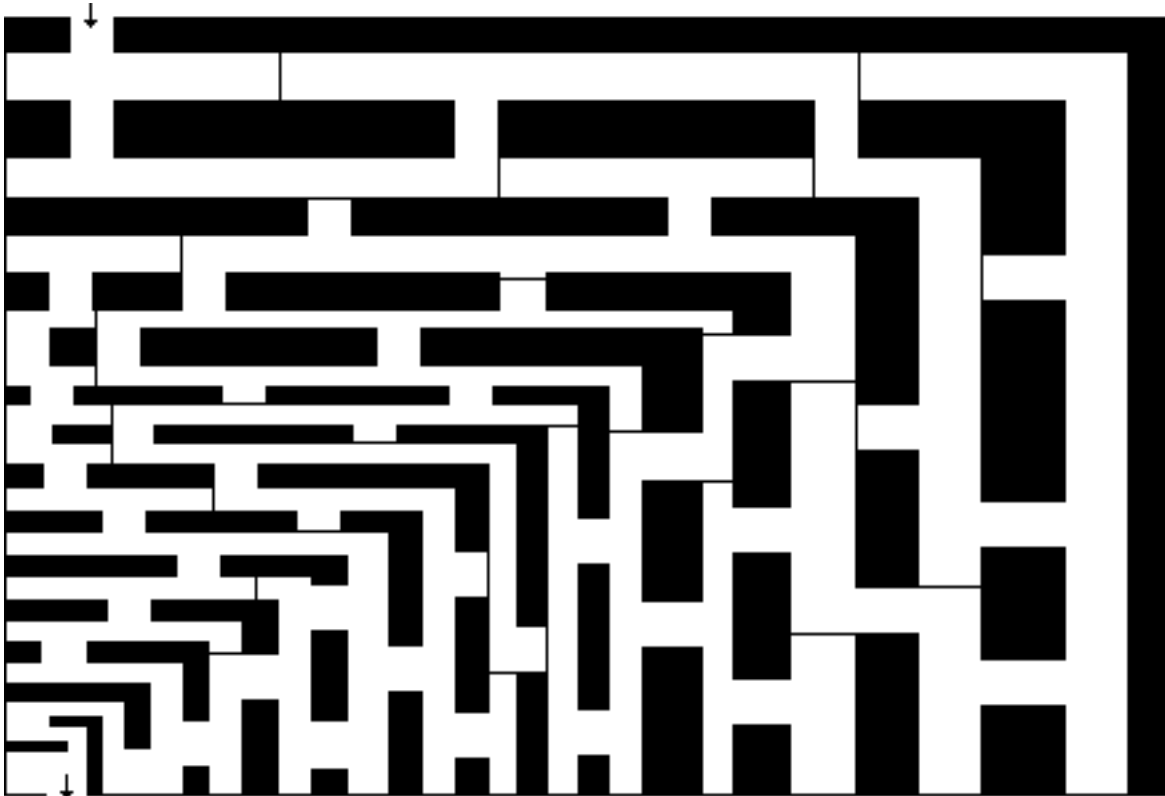

44. THE GOLDEN CALF

(EXODUS 32)

MEMORY VERSE:

"For it is written, 'You shall worship the LORD your God, and Him only you shall serve.' "
MATTHEW 4:10

FILL IN THE BLANKS:

1. "Now when the people saw that Moses delayed coming down from the mountain, the people gathered together to Aaron, and said to him, 'Come, _____ that shall go before us; for as for this Moses, the man who brought us up out of the land of Egypt, we do not know what has become of him.' " **EXODUS 32:1**
2. "And Aaron said to them, 'Break off the golden _____ which are in the ears of your wives, your sons,, and your daughters, and bring them to me.' " **EXODUS 32:2**

CIRCLE THE CORRECT WORD:

3. "And he received the gold from their hand, and he fashioned it with an engraving tool, and made a molded (ELEPHANT, CALF)." **EXODUS 32:4**

TRUE OR FALSE:

4. "And the LORD said to Moses, 'Go, get down! For your people whom you brought out of the land of Egypt have corrupted themselves.' " **EXODUS 32:7**

TRUE OR FALSE

FILL IN THE BLANK:

5. "So it was, as soon as he came near the camp, that he saw the calf and the dancing. So Moses' anger became hot, and he cast the _____ out of his hands and broke them at the foot of the mountain." **EXODUS 32:19**

UNDERLINE THE CORRECT ANSWER:

6. "Then he took the calf which they had made..." **EXODUS 32:20**
 - a. burned it in the fire
 - b. ground it to powder
 - c. scattered it on the water
 - d. made the children of Israel drink it
 - e. all of the above

FILL IN THE BLANKS:

7. "And it came to pass on the next day that Moses said to the people, 'You have sinned a _____ So now I will go up to the LORD; perhaps I can make atonement for your sin.' " **EXODUS 32:30**
8. The LORD said to Moses, "Now therefore, go, lead the people to the place of which I have spoken to you. Behold, _____ shall go before you. Nevertheless, in the day when I visit for punishment, I will visit punishment upon them for their sin." **EXODUS 32:34**
9. "So the LORD _____ the people because of what they did with the calf which Aaron made." **EXODUS 32:35**

44. THE GOLDEN CALF

(EXODUS 32)

L Y P B G W O Q T B U C A P Y U G Y L L
 R R U K D E A J N Z A U Y N B T C M U U
 H F Y K P L L I D S I N N E D O Z A F W
 I H F O C V V E R Z F J Q K B M H S L Q
 D E K J S O C C G N F D U B P J K V Y N
 Y L T Q S D R T A N T S Q C K N I R D I
 E M G S P D A R Z K A M T P P K K Y H S
 D G E P P Z L C U O Q J H L Y P R K P V
 P M Y M R Z O J N P H T T A F I E W O U
 U B G B X O Z W E O T A T G O H N L I U
 G C M B O W M Y M B R E R U J S C W R A
 I P A O S T F J D H A A D E W R V W F D
 C M Q L L H A T W F U A A D S O C Z Y D
 E W H H F Q M B Q V U U S D S W C O L W
 U N V S L I Q N L I T E E W I G H A D T
 R G V S W L S A X E T N S K A H R K F L
 M K G R V D Q S I O T Q O I G G E U B A
 K B S V L H V L T N D S M E W D M N E O
 U Y N O J T P P A H D M R P A V Q U H A
 Y K G N X Y B U L I Q N W I F B N D T P

AARON
 ANGEL
 CALF
 CORRUPTED

DRINK
 GOLD
 MOSES
 PLAGUED

SINNED
 TABLETS
 WORSHIP

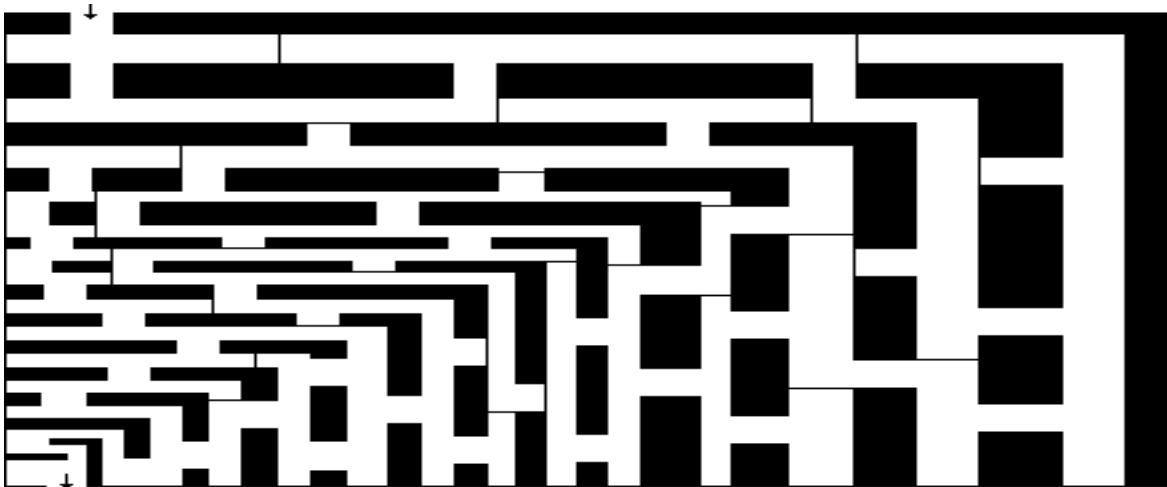

44. THE GOLDEN CALF

(EXODUS 32)

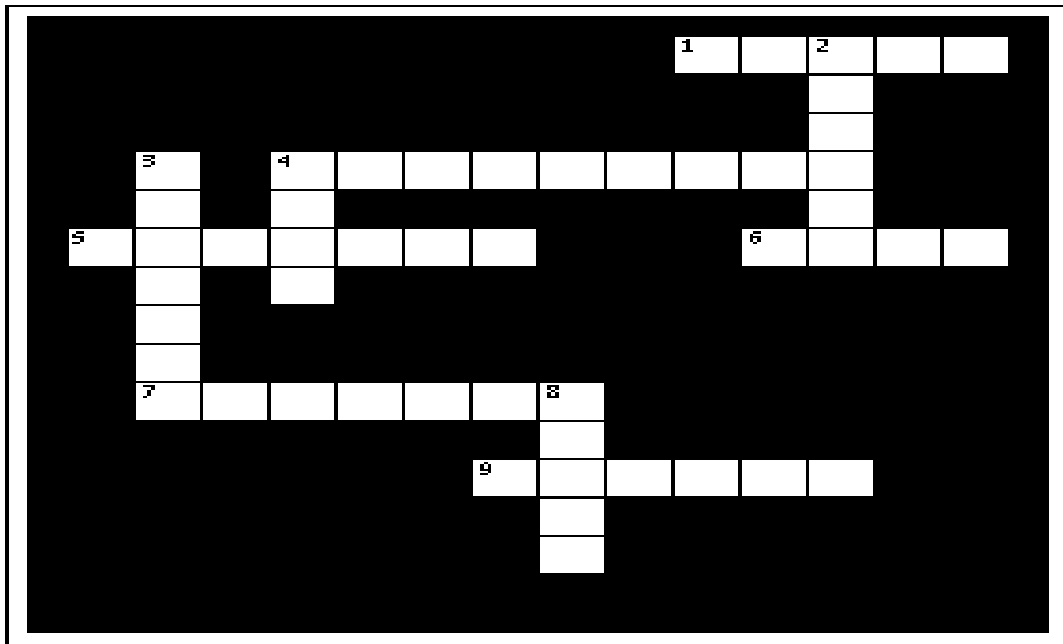

- 6 ACROSS "You shall worship the LORD your God, and Him _____ you shall serve." **MATTHEW 4:10**
- 7 ACROSS "Now when the people saw that Moses _____ coming down from the mountain, the people gathered together to Aaron, and said to him, 'Come, make us gods that shall go before us.'" **EXODUS 32:1**
- 2 DOWN "And Aaron said to them, 'Break off the _____ earrings which are in the ears of your wives, your sons, and your daughters, and bring them to me.'" **EXODUS 32:2**
- 4 DOWN "And he received the gold from their hand, and he fashioned it with an engraving tool, and made a molded _____." **EXODUS 32:4**
- 4 ACROSS "And the LORD said to Moses, 'Go, get down! For your people whom you brought out of the land of Egypt have _____ themselves.'" **EXODUS 32:7**
- 5 ACROSS "So it was, as soon as he came near the camp, that he saw the calf and the dancing. So Moses' anger became hot, and he cast the _____ out of his hands and broke them at the foot of the mountain." **EXODUS 32:19**
- 8 DOWN "Then he took the calf which they had made, burned it in the fire, and ground it to powder; and he scattered it on the water and made the children of Israel _____ it." **EXODUS 32:20**
- 9 ACROSS "And it came to pass on the next day that Moses said to the people, 'You have _____ a great sin. So now I will go up to the LORD; perhaps I can make atonement for your sin.'" **EXODUS 32:30**
- 1 ACROSS The LORD said to Moses, "Now therefore, go, lead the people to the place of which I have spoken to you. Behold, My _____ shall go before you." **EXODUS 32:34**
- 3 DOWN "So the LORD _____ the people because of what they did with the calf which Aaron made." **EXODUS 32:35**

Bible Story 45

MOSES TALKS WITH GOD

EXODUS 33:7-34:35

45. MOSES TALKS WITH GOD

(EXODUS 33:7-34:35)



"And it came to pass, as Moses entered into the tabernacle, the cloudy pillar descended, and stood *at* the door of the tabernacle, and *the LORD* talked with Moses."

EXODUS 33:9

45. MOSES TALKS WITH GOD

(EXODUS 33:7-34:35)

MEMORY VERSE:

"Now therefore, I pray, if I have found grace in Your sight, show me now Your way, that I may know You and that I may find grace in Your sight." EXODUS 33:13

TRUE OR FALSE:

1. "Moses took his tent and pitched it outside the camp, far from the camp, and called it the tabernacle of meeting." EXODUS 33:7
TRUE OR FALSE
2. "And it came to pass, when Moses entered the tabernacle, that the pillar of cloud descended and stood at the door of the tabernacle, and the LORD talked with Moses." EXODUS 33:9
TRUE OR FALSE

CIRCLE THE CORRECT WORDS:

3. "All the people saw the pillar of cloud standing at the tabernacle door, and all the people rose and (CRIED, WORSHIPED), each man in his tent door." EXODUS 33:10
4. "So the LORD spoke to Moses face to face, as a man speaks to his (FRIEND, ENEMY)." EXODUS 33:11

FILL IN THE BLANKS:

5. Moses asked of the LORD, "Now therefore, I pray, if I have found _____ in Your sight, show me now Your way, that I may know You and that I may find _____ in Your sight." EXODUS 33:13

TRUE OR FALSE:

6. "And He said, 'My Presence will go with you, and I will give you rest.' " EXODUS 33:14
TRUE OR FALSE

CIRCLE THE CORRECT WORDS:

7. "The LORD said to Moses, 'Cut two tablets of (WOOD, STONE) like the first ones, and I will write on these tablets the words that were on the first tablets which you broke.' " EXODUS 34:1
8. So Moses "was there with the LORD forty days and forty nights; he neither ate bread nor drank water. And (HE, MOSES) wrote on the tablets the words of the covenant, the Ten Commandments." EXODUS 34:28

TRUE OR FALSE:

9. Now "when Aaron and all the children of Israel saw Moses, behold, the skin of his face shone, and they were afraid to come near him." EXODUS 34:30
TRUE OR FALSE
10. Afterward all the children of Israel came near, but Moses would not give them as commandments all that the LORD had spoken with him on Mount Sinai. EXODUS 34:32
TRUE OR FALSE

45. MOSES TALKS WITH GOD (EXODUS 33:7-34:35)

E C A R G J S N Q F
D I Q R F Z T R D A
E D U O L C O N J Y
P W J B J Z N P E Y
Z Z B K T K E I Q T
P I H S R O W S R O
C K B E E C I E I F
C E C A F T O S L V
F R I E N D T O S L
Q K T S E R A M T S

CLOUD
FACE
FRIEND

GRACE
MOSES
REST

STONE
TENT
WORSHIP

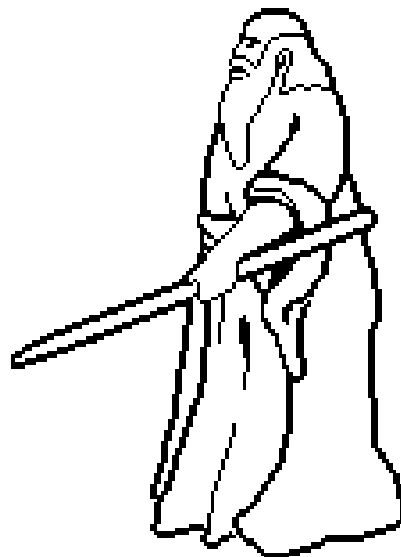

45. MOSES TALKS WITH GOD

(EXODUS 33:7-34:35)

MEMORY VERSE:

"Now therefore, I pray, if I have found grace in Your sight, show me now Your way, that I may know You and that I may find grace in Your sight." EXODUS 33:13

TRUE OR FALSE:

1. "Moses took his tent and pitched it outside the camp, far from the camp, and called it the tabernacle of meeting." EXODUS 33:7
TRUE OR FALSE
2. "And it came to pass, when Moses entered the tabernacle, that the pillar of cloud descended and stood at the door of the tabernacle, and the LORD talked with Moses." EXODUS 33:9
TRUE OR FALSE

FILL IN THE BLANKS:

3. "All the people saw the pillar of cloud standing at the tabernacle door, and all the people rose and _____, each man in his tent door." EXODUS 33:10
4. "So the LORD spoke to Moses face to face, as a man speaks to his _____." EXODUS 33:11
5. Moses asked of the LORD, "Now therefore, I pray, if I have found _____ in Your sight, show me now Your way, that I may know You and that I may find _____ in Your sight." EXODUS 33:13

TRUE OR FALSE:

6. "And He said, 'My Presence will go with you, and I will give you rest.'" EXODUS 33:14
TRUE OR FALSE

FILL IN THE BLANK:

7. "The LORD said to Moses, 'Cut two tablets of _____ like the first ones, and I will write on these tablets the words that were on the first tablets which you broke.'" EXODUS 34:1

CIRCLE THE CORRECT WORD:

8. So Moses "was there with the LORD forty days and forty nights; he neither ate bread nor drank water. And (HE, MOSES) wrote on the tablets the words of the covenant, the Ten Commandments." EXODUS 34:28

FILL IN THE BLANK:

9. Now "when Aaron and all the children of Israel saw Moses, behold, the skin of his face _____, and they were afraid to come near him." EXODUS 34:30

TRUE OR FALSE:

10. Afterward all the children of Israel came near, but Moses would not give them as commandments all that the LORD had spoken with him on Mount Sinai. EXODUS 34:32
TRUE OR FALSE

45. MOSES TALKS WITH GOD

(EXODUS 33:7-34:35)

B N G E A Q N Q O D X N P I G C L O S U
 Y B D L V J A X N Q N K Y A D C W I V X
 K K P V C I D I H T A B E R N A C L E S
 B K E D C C S E I C A B F G V H W R U E
 U O K N A O L T P L F A C E N O T S U J
 Y J S D O T M A U I Y C O W B R Z F A M
 F Q P Z L H P M A J H D J A G E O Y D G
 K S P Z O C S L A K Q S W F C M A X D O
 T P R C L O U D D N U W R U Z Q K D W V
 G M X O Z S U B F N D K T O H N M F T S
 E G O W M E T Z F S E M S S W Y N B L P
 Y B R H F S N Z T M Q I E T E M U E A T
 G B S A M O D N Q J T I R N K R D H O W
 M O L Q C M R K H T H E R F T A L T A B
 Q H K I Q E A O A A T P A O K S U L P H
 H S W L S J Z B U A T I L M R S F U A J
 V S V H Q W E H U U R Y L J E V L W D Y
 V R J T V Y M F T E R B I M N Y Y Q Y K
 G V X Y P J D V T N W B P G C K H N S P
 S N W O B T W I D Q P P S H V W X I M G

CLOUD
 COMMANDMENTS
 FACE
 FRIEND

GRACE
 MOSES
 PILLAR
 REST

SHONE
 STONE
 TABERNACLE
 WORSHIPED

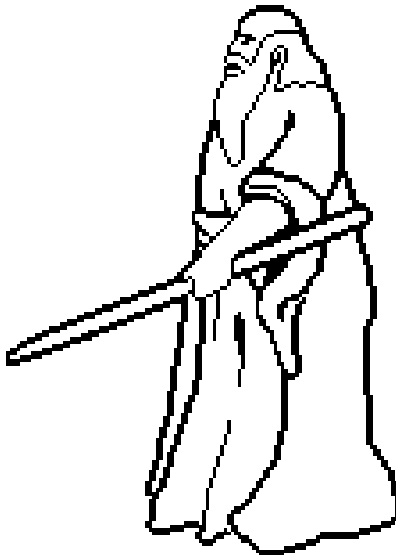

45. MOSES TALKS WITH GOD

(EXODUS 33:7-34:35)

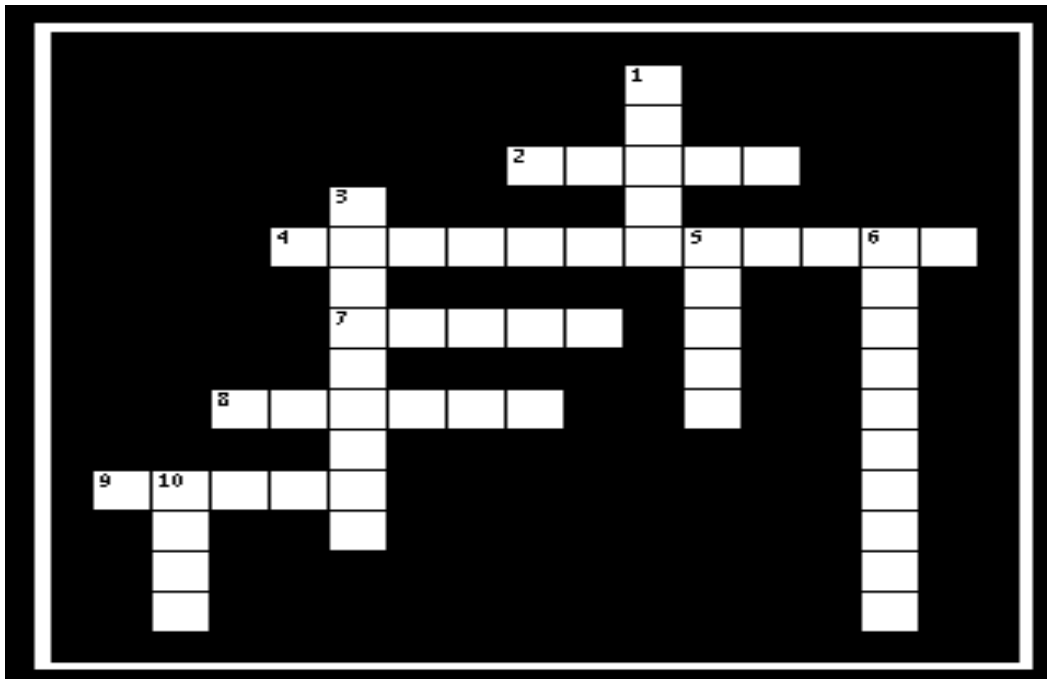

- 9 ACROSS "Now therefore, I pray, if I have found _____ in Your sight, show me now Your way, that I may know You and that I may find grace in Your sight." **EXODUS 33:13**
- 6 DOWN "Moses took his tent and pitched it outside the camp, far from the camp, and called it the _____ of meeting." **EXODUS 33:7**
- 1 DOWN "And it came to pass, when Moses entered the tabernacle, that the pillar of _____ descended and stood at the door of the tabernacle, and the LORD talked with Moses." **EXODUS 33:9**
- 3 DOWN "All the people saw the pillar of cloud standing at the tabernacle door, and all the people rose and _____, each man in his tent door." **EXODUS 33:10**
- 8 ACROSS "So the LORD spoke to Moses face to face, as a man speaks to his _____." **EXODUS 33:11**
- 10 DOWN "And He said, 'My Presence will go with you, and I will give you _____.'" **EXODUS 33:14**
- 2 ACROSS "The LORD said to Moses, 'Cut two tablets of _____ like the first ones, and I will write on these tablets the words that were on the first tablets which you broke.'" **EXODUS 34:1**
- 5 DOWN "So _____ made haste and bowed his head toward the earth, and worshiped." **EXODUS 34:8**
- 7 ACROSS Now "when Aaron and all the children of Israel saw Moses, behold, the skin of his face _____, and they were afraid to come near him." **EXODUS 34:30**
- 4 ACROSS "Afterward all the children of Israel came near, and he gave them as _____ all that the LORD had spoken with him on Mount Sinai." **EXODUS 34:32**

Bible Story 46

THE TABERNACLE

EXODUS 36:8-40:38

46. THE TABERNACLE (EXODUS 36:8-40:38)



"And they came, every one whose heart stirred him up, and every one whom his spirit made willing, *and* they brought the LORD'S offering to the work of the tabernacle of the congregation, and for all his service, and for the holy garments."

EXODUS 35:21

46. THE TABERNACLE

(EXODUS 36:8-40:38)

MEMORY VERSE:

"How lovely is Your tabernacle , O LORD of hosts!" PSALM 84:1

CIRCLE THE CORRECT WORDS:

1. "All the gifted artisans among them who worked on the tabernacle made ten (**CURTAINS, CAPTAINS**) woven of fine linen thread, and blue and purple and scarlet yarn; with artistic designs of cherubim they made them." **EXODUS 36:8**
2. "He made curtains of goat's hair for the (**TENT, FLAG**) over the tabernacle; he made eleven curtains." **EXODUS 36:14**
3. "Then he made a covering for the tent of (**COWS', RAMS'**) skins dyed red, and a covering of (**BADGER, GATOR**) skins above that." **EXODUS 36:19**
4. "For the tabernacle he made boards of acacia (**STEEL, WOOD**), standing upright." **EXODUS 36:20**
5. "He overlaid the boards with (**GOLD, SILVER**), made their rings of (**GOLD, BRASS**) to be holders for the bars, and overlaid the bars with (**GOLD, COPPER**)." **EXODUS 36:34**
6. "And he made a (**VEST, VEIL**) woven of blue and purple and scarlet yarn, and fine linen thread; it was woven with an artistic design of cherubim." **EXODUS 36:35**
7. "He also made (**SCREEN, KNOB**) for the tabernacle door, woven of blue and purple and scarlet yarn, and fine linen thread, made by a weaver." **EXODUS 36:37**

TRUE OR FALSE: (Circle T for True or F for False)

- | | | |
|--|---|---|
| 8. "Then Bezaleel made the ark of acacia wood." EXODUS 37:1 | T | F |
| "He overlaid it with pure gold inside and outside." EXODUS 37:2 | T | F |
| "He also made the mercy seat of pure gold." EXODUS 37:6 | T | F |
| "He made two cherubim of beaten gold." EXODUS 37:7 | T | F |
| "He did not make the table for the showbread of acacia wood." EXODUS 37:10 | T | F |
| "He made of pure gold the utensils which were on the table." EXODUS 37:16 | T | F |
| "He also made the lampstand of pure gold." EXODUS 37:17 | T | F |
| "He made its seven lamps, its wick-trimmers, and its trays of pure gold." EXODUS 37:23 | T | F |
| "He did not make the incense altar of acacia wood." EXODUS 37:25 | T | F |
| "He overlaid it with pure gold: its top, its sides all around, and its horns." EXODUS 37:26 | T | F |
| "He also made the holy anointing oil and pure incense of sweet spices." EXODUS 37:29 | T | F |
| "He made the altar of burnt offering of acacia wood." EXODUS 38:1 | T | F |
| "He made its horns on its four corners...And he overlaid it with bronze." EXODUS 38:2 | T | F |
| "He made the laver of bronze and its base of bronze." EXODUS 38:8 | T | F |
| "All the hangings of the court all around were woven of rough old linen." EXODUS 38:16 | T | F |

FILL IN THE BLANKS:

"Then Moses looked over all the work, and indeed they had done it; as _____ had commanded, just so they had done it. And Moses blessed them." **EXODUS 39:43**

46. THE TABERNACLE

(EXODUS 36:8-40:38)

A E L B A T A T L S O H W X N
 Q A Z W Z R J A S L J G Y G G
 F M U R K K T N T R A E P Y Z
 H V E I L Q E R Y V A M Z P J
 P R S N I A T R U C J T P Y P
 J T A P C J J P L M R U L S N
 L Y N E C B Z I A A E E W A U
 A L M S Q B Z Q Y Z A W M B O
 V E L C A N R E B A T E B D F
 E I G G I R K D Y S W Z O R L
 R O F D W B C J O H L N M I L
 T V H E Z K T Q F M Z O W C L
 L A M P S T A N D B B R U G M
 B Q A P K E I R V S P B N R S
 I D L O G F O I P V J D I G Z

ALTAR
 ARK
 BRONZE
 CURTAINS

GOLD
 LAMPSTAND
 LAMPS

LAVAR
 MERCY
 OIL

TABERNACLE
 TABLE
 VEIL

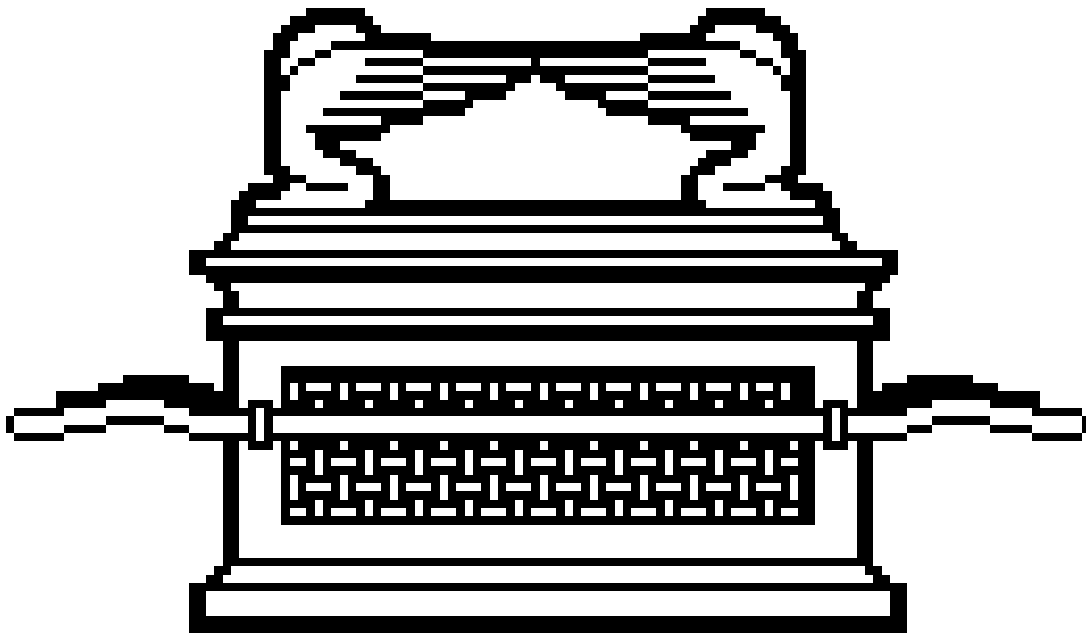

46. THE TABERNACLE

(EXODUS 36:8-40:38)

MEMORY VERSE:

"How lovely is Your tabernacle , O LORD of hosts!" PSALM 84:1

FILL IN THE BLANKS:

1. "All the gifted artisans among them who worked on the tabernacle made ten _____ woven of fine linen thread, and blue and purple and scarlet yarn; with artistic designs of cherubim they made them." **EXODUS 36:8**
2. "He made curtains of goat's hair for the _____ over the tabernacle; he made eleven curtains." **EXODUS 36:14**
3. "Then he made a covering for the tent of _____ skins dyed red, and a covering of _____ skins above that." **EXODUS 36:19**
4. "For the tabernacle he made boards of _____, standing upright." **EXODUS 36:20**
5. "He overlaid the boards with _____, made their rings of _____ to be holders for the bars, and overlaid the bars with _____." **EXODUS 36:34**
6. "And he made a _____ woven of blue and purple and scarlet yarn, and fine linen thread; it was woven with an artistic design of cherubim." **EXODUS 36:35**
7. "He also made _____ for the tabernacle door, woven of blue and purple and scarlet yarn, and fine linen thread, made by a weaver." **EXODUS 36:37**

TRUE OR FALSE: (Circle T for True or F for False)

- | | | |
|--|---|---|
| 8. "Then Bezaleel made the ark of acacia wood." EXODUS 37:1 | T | F |
| "He overlaid it with pure gold inside and outside." EXODUS 37:2 | T | F |
| "He also made the mercy seat of pure gold." EXODUS 37:6 | T | F |
| "He made two cherubim of beaten gold." EXODUS 37:7 | T | F |
| "He did not make the table for the showbread of acacia wood." EXODUS 37:10 | T | F |
| "He made of pure gold the utensils which were on the table." EXODUS 37:16 | T | F |
| "He also made the lampstand of pure gold." EXODUS 37:17 | T | F |
| "He made its seven lamps, its wick-trimmers, and its trays of pure gold." EXODUS 37:23 | T | F |
| "He did not make the incense altar of acacia wood." EXODUS 37:25 | T | F |
| "He overlaid it with pure gold: its top, its sides all around, and its horns." EXODUS 37:26 | T | F |
| "He also made the holy anointing oil and pure incense of sweet spices." EXODUS 37:29 | T | F |
| "He made the altar of burnt offering of acacia wood." EXODUS 38:1 | T | F |
| "He made its horns on its four corners...And he overlaid it with bronze." EXODUS 38:2 | T | F |
| "He made the laver of bronze and its base of bronze." EXODUS 38:8 | T | F |
| "All the hangings of the court all around were woven of rough old linen." EXODUS 38:16 | T | F |

FILL IN THE BLANKS:

"Then Moses looked over all the work, and indeed they had done it; as _____ had commanded, just so they had done it. And Moses blessed them." **EXODUS 39:43**

46. THE TABERNACLE

(EXODUS 36:8-40:38)

J D O Q M U D F O K Q O O L D U O G R Y
 W W B H J Q W O M K N A I U W X V P W T
 Y Q H A S T D J J L A M P S T A N D G W
 J X S P T H K A K R Y W R W T S S S T U
 T I M N T A I W E E P U R E G O L D K G
 N A F U I T B S G R M P F Q L E P O W H
 L T V U A A E E H N B N Y N A J T T I N
 A A I T A T T S R C L W L I O D W W U V
 S B R O N Z E R G N A A O I O O B I M S
 L L O T U R P I U V A U V H A O H H F U
 P M N D E R I A D C S C L E S W J J T L
 U B E D N W Y G V C V D L S R A D D N H
 T Z H R Q R A T L A Y L D E P I L U E U
 N Z I Q C P B W G N I R E V O C O O T Q
 D K L C X Y B A B C K U V V A A G L O T
 R R A N N N S F G H W F F E D C Y O E P
 A A F J A K P E C R L L B U I A K U P L
 Z N F L Y B P U A E W Y E U Y L P I K J
 E I N C E N S E Z T W H H A S M G I J B
 M K T S Q C Y T H M Z X T D M G K B F J

ACACIA WOOD
 ALTAR
 ARK
 BRONZE
 COVERING

CURTAINS
 GOLD
 INCENSE
 LAMPS
 LAMPSTAND

LAVER
 MERCY SEAT
 OIL
 PURE GOLD

SHOWBREAD
 TABERNACLE
 TENT
 VEIL

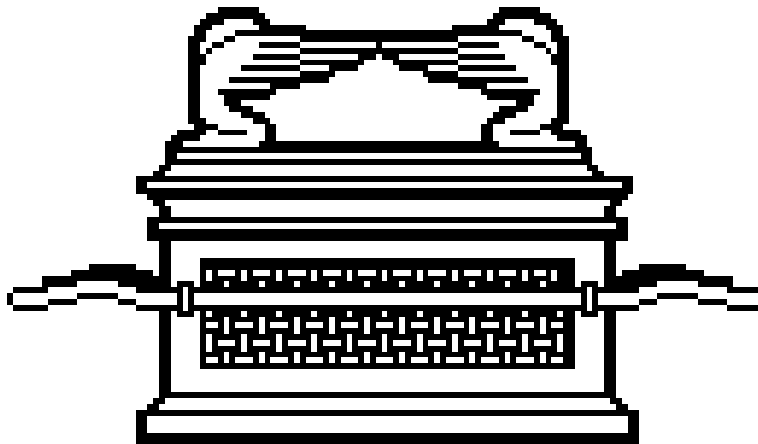

46. THE TABERNACLE

(EXODUS 36:8-40:38)

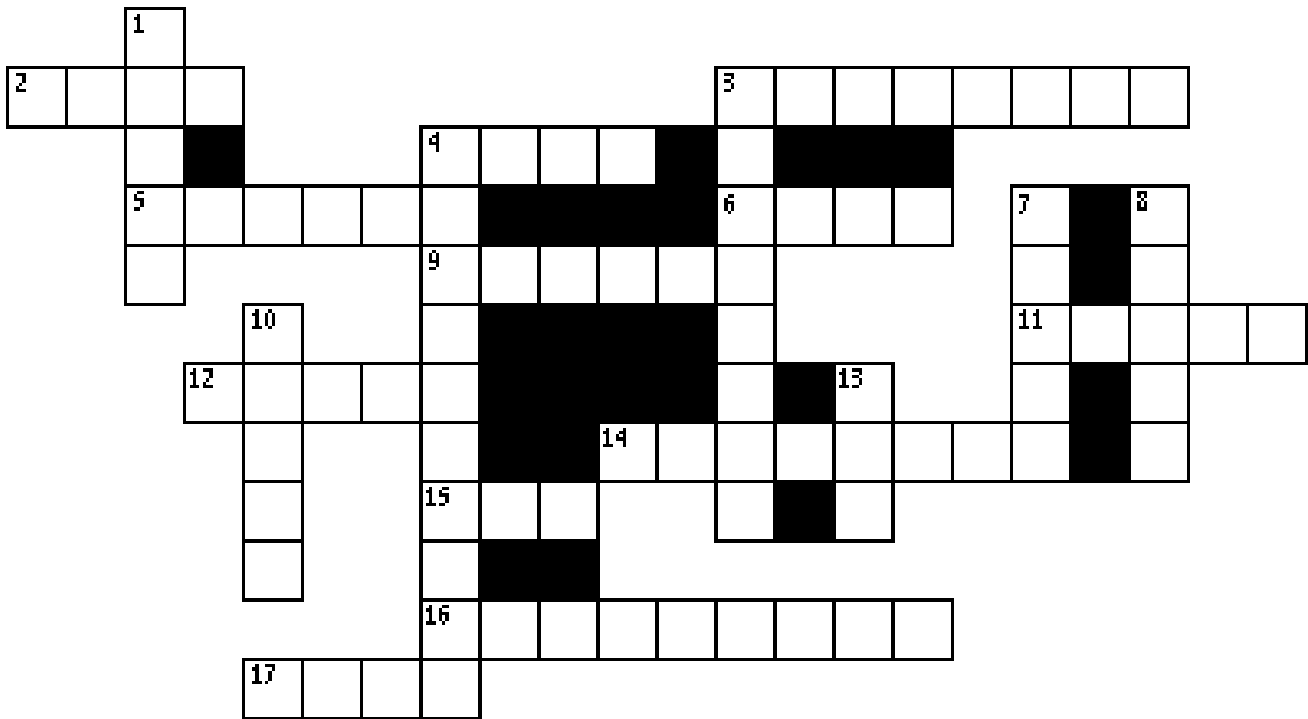

- 4 DOWN "How lovely is Your _____, O LORD of hosts!" **PSALM 84:1**
- 3 ACROSS "All the gifted artisans among them who worked on the tabernacle made ten _____" **EXODUS 36:8**
- 4 ACROSS "He made curtains of goat's hair for the _____ over the tabernacle." **EXODUS 36:14**
- 3 DOWN "Then he made a _____ for the tent of rams' skins dyed red." **EXODUS 36:19**
- 2 ACROSS "He overlaid the boards with _____." **EXODUS 36:34**
- 6 ACROSS "And he made a _____ woven of blue and purple and scarlet yarn." **EXODUS 36:35**
- 15 ACROSS "Then Bezaleel made the _____ of acacia wood." **EXODUS 37:1**
- 17 ACROSS "He overlaid it with _____ gold inside and outside." **EXODUS 37:2**
- 11 ACROSS "He also made the _____ seat of pure gold." **EXODUS 37:6**
- 10 DOWN "He made the _____ of acacia wood." **EXODUS 37:10**
- 16 ACROSS "He also made the _____ of pure gold." **EXODUS 37:17**
- 7 DOWN "He made its seven _____, its wick-trimmers, and its trays of pure gold." **EXODUS 37:23**
- 1 DOWN "He made the incense _____ of acacia wood." **EXODUS 37:25**
- 8 DOWN "He overlaid it with pure gold: its top, its sides all around, and its _____." **EXODUS 37:26**
- 13 DOWN "He also made the holy anointing _____ and pure incense of sweet spices." **EXODUS 37:29**
- 5 ACROSS "He made the altar of burnt offering of _____ wood." **EXODUS 38:1**
- 9 ACROSS "He made its horns on its four corners...And he overlaid it with _____." **EXODUS 38:2**
- 12 ACROSS "He made the _____ of bronze and its base of bronze." **EXODUS 38:8**
- 14 ACROSS "All the _____ of the court all around were woven of fine linen." **EXODUS 38:16**

Bible Story 47

THE CLOUD & THE FIRE

NUMBERS 9:15-23

47. THE CLOUD AND THE FIRE

(NUMBERS 9:15-23)

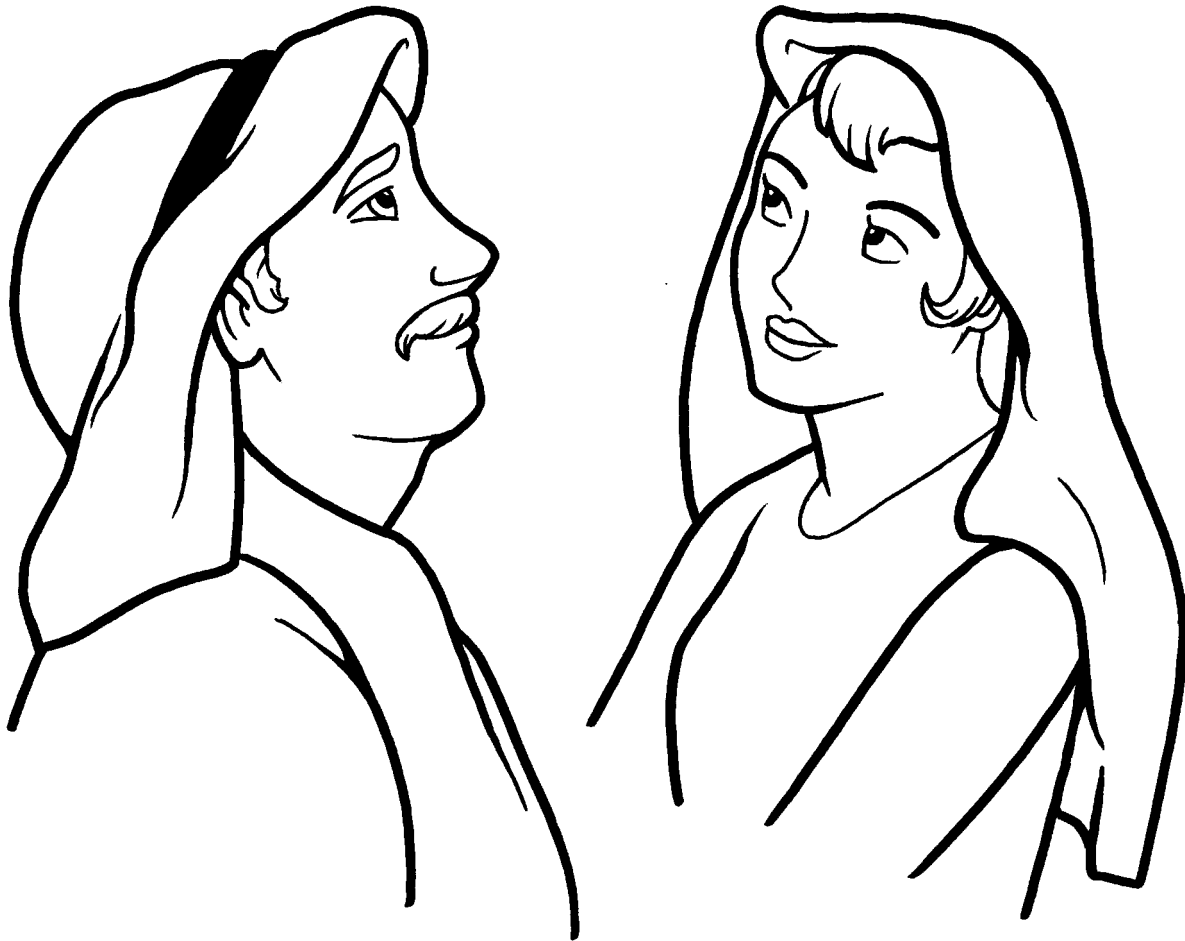
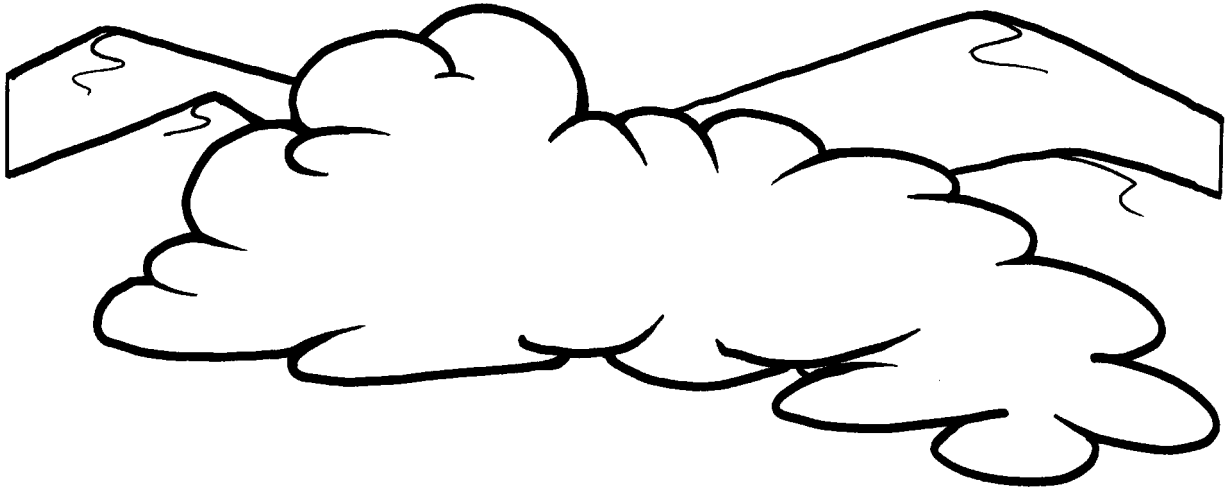

"And on the day that the tabernacle was reared up the cloud covered the tabernacle, *namely*, the tent of the testimony: and at even there was upon the tabernacle as it were the appearance of fire, until the morning."

NUMBERS 9:15

47. THE CLOUD AND THE FIRE

(NUMBERS 9:15-23)

MEMORY VERSE:

"At the command of the LORD they remained encamped, and at the command of the LORD they journeyed; they kept the charge of the LORD, at the command of the LORD by the hand of Moses." NUMBERS 9:23

TRUE OR FALSE:

1. "On the day that the tabernacle was raised up, the cloud covered the tabernacle, the tent of the Testimony; from the evening until morning it was above the tabernacle like the appearance of fire." **NUMBERS 9:15**
TRUE OR FALSE

FILL IN THE BLANKS:

2. "So it was always: the _____ covered it by day, and the appearance of _____ by night." **NUMBERS 9:16**

UNDERLINE THE CORRECT ANSWER:

3. "Whenever the cloud was taken up from above the tabernacle,..." **NUMBERS 9:17**
 - a. the weather was great
 - b. the children of Israel would journey
 - c. the children of Israel would stay in their tents
4. "In the place where the cloud settled,..." **NUMBERS 9:17**
 - a. the children of Israel would pitch their tents
 - b. the children of Israel would stay away from
 - c. neither of these answers

TRUE OR FALSE:

5. "Whether it was two days, a month, or a year that the cloud remained above the tabernacle, the children of Israel would remained encamped and not journey." **NUMBERS 9:22**
TRUE OR FALSE
6. But when it was taken up, they would stay right where they were and not move. **NUMBERS 9:22**
TRUE OR FALSE

47. THE CLOUD AND THE FIRE

(NUMBERS 9:15-23)

A	D	U	O	L	C	K	Q	Y	M	P	W	F	R	L
M	Q	X	C	G	K	C	D	Y	F	J	Y	A	D	M
X	Z	P	Q	N	E	T	J	O	S	H	B	I	N	S
T	U	E	I	I	F	I	Q	F	V	G	M	N	N	Z
Y	A	Y	E	N	R	U	O	J	O	L	O	R	D	F
L	N	S	W	E	J	O	R	V	J	E	W	G	G	P
M	M	G	Z	V	T	T	I	L	T	H	G	I	N	G
O	G	D	K	E	E	A	L	S	J	U	U	Y	Z	K
S	E	L	C	A	N	R	E	B	A	T	G	P	J	B
E	F	E	K	E	R	I	F	V	E	W	N	Y	P	U
S	H	P	Q	B	J	N	S	M	A	D	I	B	N	K
I	A	Z	J	R	Z	R	T	A	W	W	N	D	P	C
E	N	C	A	M	P	E	D	Z	L	Y	R	R	O	U
O	W	C	B	B	Z	P	F	S	Z	P	O	C	F	M
V	S	T	N	E	T	I	A	H	L	Z	M	G	L	D

CLOUD
DAY
ENCAMPED
EVENING

FIRE
JOURNEY
LORD
MORNING

MOSES
NIGHT
TABERNACLE
TENTS

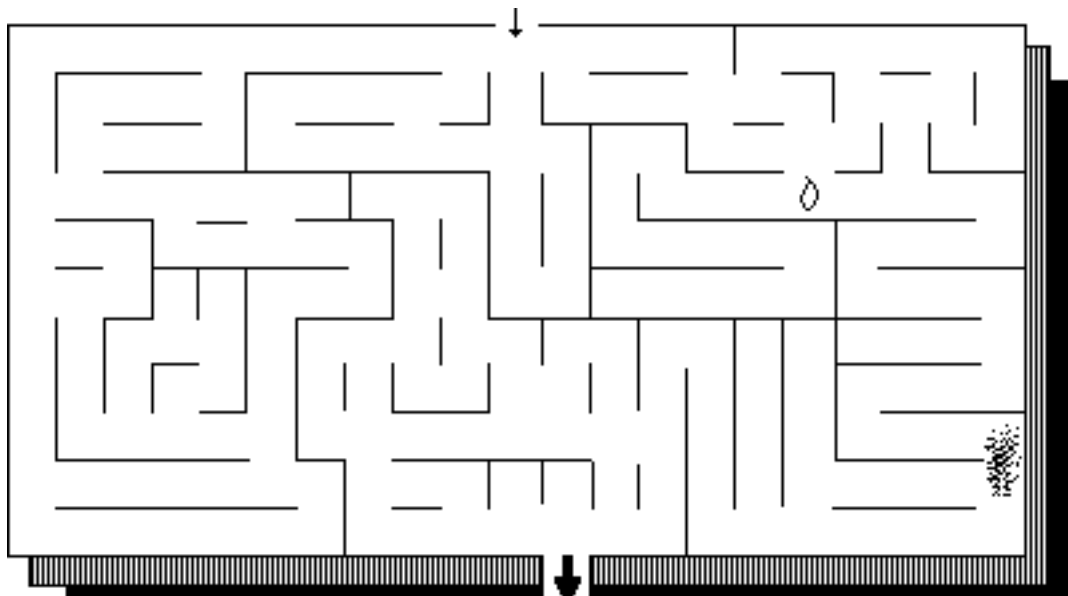

47. THE CLOUD AND THE FIRE

(NUMBERS 9:15-23)

MEMORY VERSE:

"At the command of the LORD they remained encamped, and at the command of the LORD they journeyed; they kept the charge of the LORD, at the command of the LORD by the hand of Moses." NUMBERS 9:23

FILL IN THE BLANKS:

1. "On the day that the tabernacle was raised up, the cloud covered the tabernacle, the tent of the Testimony; from the _____ until _____ it was above the tabernacle like the appearance of fire." **NUMBERS 9:15**
2. "So it was always: the _____ covered it by day, and the appearance of _____ by night." **NUMBERS 9:16**

UNDERLINE THE CORRECT ANSWER:

3. "Whenever the cloud was taken up from above the tabernacle,..." **NUMBERS 9:17**
 - a. the weather was great
 - b. the children of Israel would journey
 - c. the children of Israel would stay in their tents
 - d. there was a great feast

FILL IN THE BLANKS:

4. "In the place where the cloud settled, the children of Israel would pitch their _____." **NUMBERS 9:17**
5. "Whether it was two _____, a _____, or a _____ that the cloud remained above the tabernacle, the children of Israel would remained encamped and not journey." **NUMBERS 9:22**

TRUE OR FALSE:

6. But when it was taken up, they would stay right where they were and not move. **NUMBERS 9:22**

TRUE OR FALSE

47. THE CLOUD AND THE FIRE

(NUMBERS 9:15-23)

H S V H Q T M O A T T K W K C W D T A B
 V R J T V N D B U A H I S G V L L L P H
 V V X Y P A G H U E V E N I N G U U A J
 G N T O T S W N T A T E S H C W F W D Y
 S G W H B A Q F I U T P I S T N E T Y K
 N D E A G L B V T N R I A G C W L Q S P
 B P L V Q I X E D E R Y G D H Z Y N M G
 K K V C J P N I R N R O W V R D H I U K
 K S D F I R E O Y N W B M B E N P S L G
 O P D A D U I N D E A B A G M A O V S P
 J C Z L I A T H Q Q N C F C Q M I U E S
 Q P L O C E Y I C L P R L Z N M R U J O
 S R Z O T T N U U N N P U E Y O F A M T
 P W O Z U N A C S E S O M O M C Y D G W
 M O W M C D L A A A K P U H J O Y D O I
 B S H F J D B F J M B Y T L A A D W V H
 B L Q M W R Z F K Y P F O L S L F T S J
 O K I Q Y A Z T S Q C E M R V U B L P D
 H L O R D Z N Q M U D O D E Y N E A T U
 S W L S J E K H J Q W J J N K U H O W O

CLOUD
 COMMAND
 DAY
 ENCAMPED
 EVENING

FIRE
 JOURNEY
 LORD
 MORNING

MOSES
 NIGHT
 TABERNACLE
 TENTS

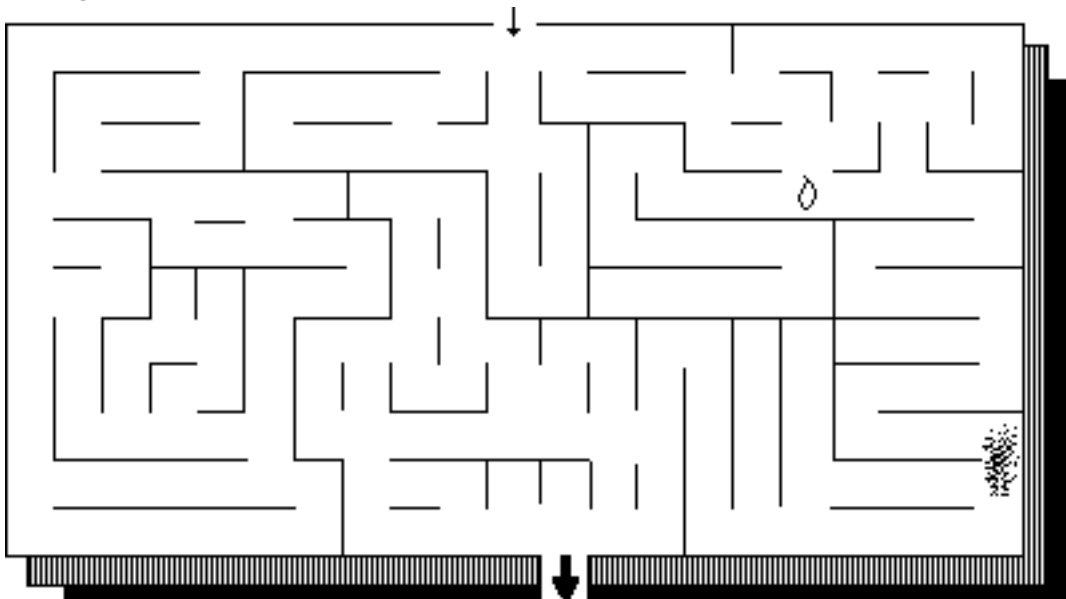

47. THE CLOUD AND THE FIRE

(NUMBERS 9:15-23)

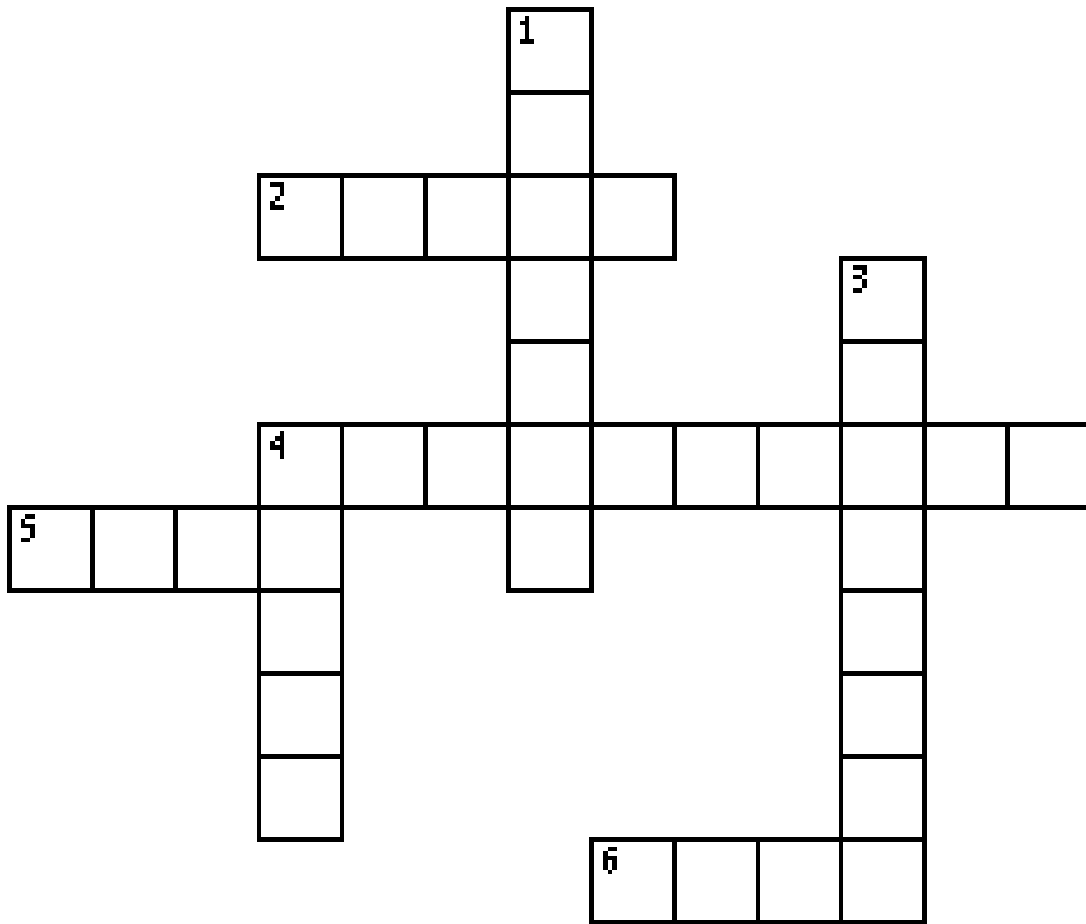

- 6 ACROSS "At the command of the _____ they remained encamped, and at the command of the LORD they journeyed; they kept charge of the LORD, at the command of the LORD by the hand of Moses." **NUMBERS 9:23**
- 2 ACROSS "On the day that the tabernacle was raised up, the _____ covered the tabernacle, the tent of the Testimony; from the evening until morning it was above the tabernacle like the appearance of fire." **NUMBERS 9:15**
- 5 ACROSS "So it was always: the cloud covered it by day, and the appearance of _____ by night." **NUMBERS 9:16**
- 4 ACROSS "Whenever the cloud was taken up from above the _____, after that the children of Israel would journey." **NUMBERS 9:17**
- 4 DOWN "In the place where the cloud settled, there the children of Israel would pitch their _____." **NUMBERS 9:17**
- 3 DOWN "Whether it was two days, a month, or a year that the cloud remained above the tabernacle, the children of Israel would remained _____ and not journey." **NUMBERS 9:22**
- 1 DOWN "But when it was taken up, they would _____." **NUMBERS 9:22**

Bible Story 48

THE LORD SENDS QUAIL

NUMBERS 11:4-14, 31-34

48. THE LORD SENDS QUAIL (NUMBERS 11:4-14, 31-34)

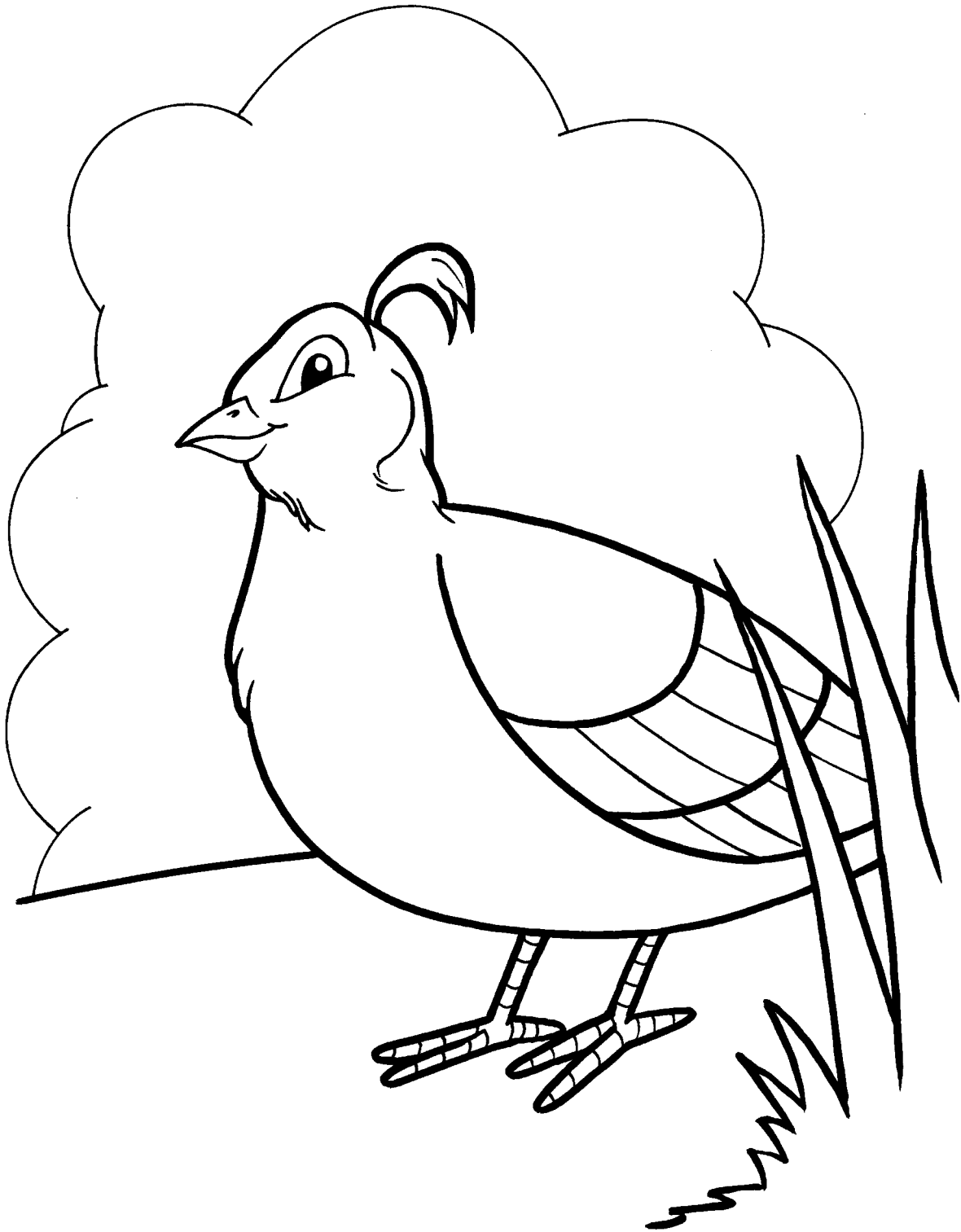

"And there went forth a wind from the LORD, and brought quails from the sea, and let *them* fall by the camp, as it were a day's journey on this side, and as it were a day's journey on the other side, round about the camp, and as it were two cubits *high* upon the face of the earth."

NUMBERS 11:31

48. THE LORD SENDS QUAIL (NUMBERS 11:4-14, 31-34)

MEMORY VERSE:

"For the drunkard and the glutton will come to poverty, and drowsiness will clothe a man with rags."
PROVERBS 23:21

TRUE OR FALSE:

1. "The children of Israel also wept again and said, 'Who will give us meat to eat?' " **NUMBERS 11:4**
TRUE OR FALSE

CIRCLE ALL THE CORRECT WORDS:

2. What did the people remember eating in Egypt? **NUMBERS 11:5**

FISH	CUCUMBERS	FRENCH FRIES
MELONS	HAMBURGERS	LEEKs
ORANGES	ONIONS	GARLIC

3. They said, "But now our whole being is dried up; there is nothing at all except this
(**BANANA, MANNA**) before our eyes!" **NUMBERS 11:6**

TRUE OR FALSE:

4. "Now the manna was like coriander seed, and its color like the color of bdellium." **NUMBERS 11:7**
TRUE OR FALSE

UNDERLINE THE CORRECT ANSWER:

5. "The people went about and..." **NUMBERS 11:8**

a. gathered it
b. ground it on millstones or beat it in the mortar
c. cooked it in pans
d. made cakes of it
e. all of the above

6. "Now Moses heard the people weeping throughout their families, everyone at the door of his tent;" **NUMBERS 11:10**

a. and the anger of the LORD was greatly aroused
b. Moses also was displeased
c. both of these

CIRCLE THE CORRECT WORD:

7. "Now a wind went out from the LORD, and it brought (**QUAIL, HAIL**) from the sea and left them fluttering near the camp." **NUMBERS 11:31**

TRUE OR FALSE:

8. "And the people stayed up all that day, all that night, and all the next day, and gathered the quail." **NUMBERS 11:32**

TRUE OR FALSE

CIRCLE THE CORRECT WORD:

9. "But while the meat was still between their teeth, before it was chewed, the wrath of the LORD was aroused against the people, and the LORD struck the people with a very great (**STICK, PLAGUE**)." **NUMBERS 11:33**

48. THE LORD SENDS QUAIL

(NUMBERS 11:4-14, 31-34)

M A N G E R V M V U
A L O R D P T O H D
N E U G A L P S T S
N Y A H N L W E A J
A O M E A T H S R L
D E R E H T A G W I
P S E K A C P Q M A
Z J H Z J J J O F U
G L U T T O N A S Q
Y F A Y T C H W W H

ANGER
CAKES
EAT

GATHERED
GLUTTON
LORD

MANNA
MEAT
MOSES

PLAGUE
QUAIL
WRATH

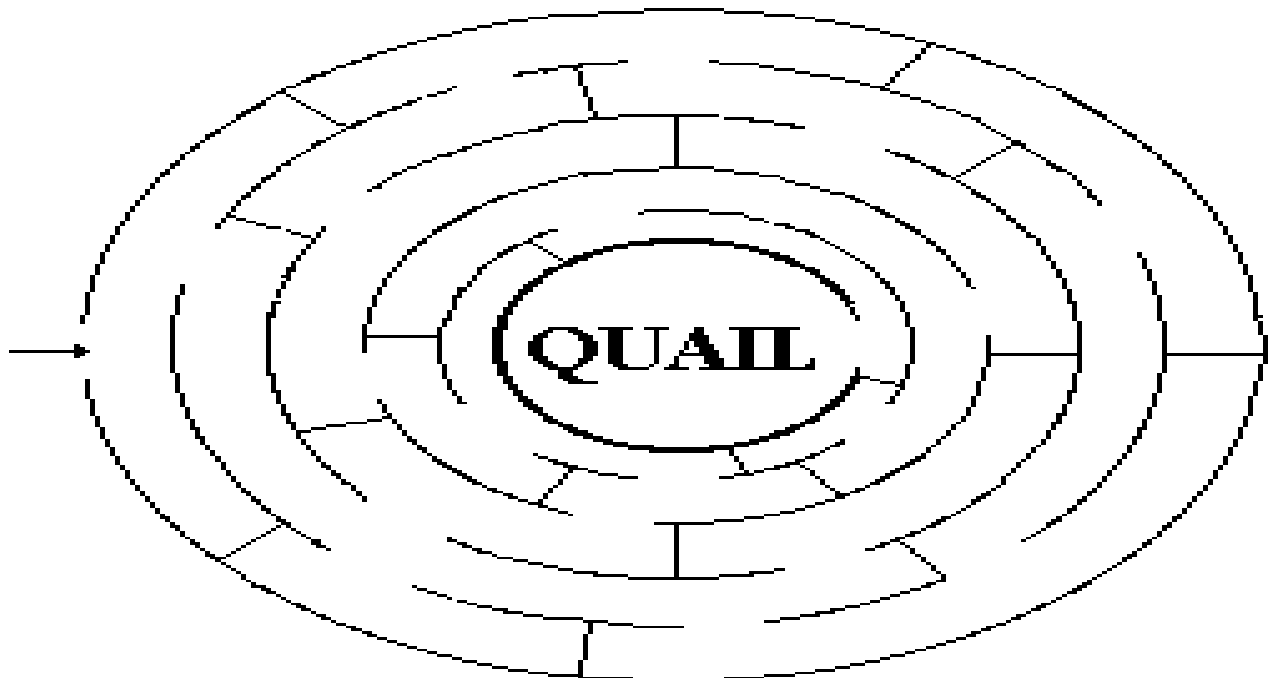

48. THE LORD SENDS QUAIL (NUMBERS 11:4-14, 31-34)

MEMORY VERSE:

"For the drunkard and the glutton will come to poverty, and drowsiness will clothe a man with rags."
PROVERBS 23:21

TRUE OR FALSE:

1. "The children of Israel also wept again and said, 'Who will give us meat to eat?' " **NUMBERS 11:4**
TRUE OR FALSE

CIRCLE ALL THE CORRECT WORDS:

2. What did the people remember eating in Egypt? **NUMBERS 11:5**

FISH	CUCUMBERS	FRENCH FRIES
MELONS	HAMBURGERS	LEEKs
ORANGES	ONIONS	GARLIC

FILL IN THE BLANK:

3. They said, "But now our whole being is dried up; there is nothing at all except this _____ before our eyes!" **NUMBERS 11:6**

UNDERLINE THE CORRECT ANSWER:

4. "The people went about and..." **NUMBERS 11:8**
a. gathered it
b. ground it on millstones or beat it in the mortar
c. cooked it in pans
d. made cakes of it
e. all of the above
5. "Now Moses heard the people weeping throughout their families, everyone at the door of his tent; **NUMBERS 11:10**
a. and the anger of the LORD was greatly aroused
b. Moses also was displeased
c. both of these

FILL IN THE BLANKS:

6. Moses asked the LORD, 'Where am I to get _____ to give all these people? For they weep all over me, saying, 'Give us _____, that we may eat.' " **NUMBERS 11:13**
7. "Now a wind went out from the LORD, and it brought _____ from the sea and left them fluttering near the camp." **NUMBERS 11:31**
8. "And the people stayed up all that day, all that night, and all the next day, and _____ the quail." **NUMBERS 11:32**
9. "But while the meat was still between their teeth, before it was chewed, the wrath of the LORD was aroused against the people, and the LORD struck the people with a very great _____." **NUMBERS 11:33**

48. THE LORD SENDS QUAIL

(NUMBERS 11:4-14, 31-34)

I H F O K V C C R Z A C A N B M K Y H I
 D E K J S D A T A N F M Y K P J R K L S
 Y L T Q P D L C Z M A N N A P K E W O V
 E M G S G Z L I E K F J Q B Y G N L I U
 D G E P P A O J A O T K U C F H C W R U
 P M Y M R Z T W M U Q S Q D R E G N A A
 U B G B X O Z H D B Q M T P O G V W F D
 G P M B O W M Y E H H J H L J H C Z Y D
 I M Q O S H F J S R A T T A W T C O L W
 C W H H L Q M T W E E A T G S A H A D T
 E M V S K I Q N Q P K D R U S R R L F L
 U N E S W G S A G V J A R E I W E P B A
 P G V A V L L S I I U A C W A D M N E O
 M K G R T H Q U T A E U S K G V Q U H A
 K B S V J T V L T O T E E I W B N D T P
 U Y N N X Y P P T T T N S E A G Y L L A
 Y K B G W D B U A N O Q O P F C M U U D
 Y P K D R O Q T L H D N M I U Z A F W Y
 R L K O E A J N B I D X W Y T H S L Q S
 M Y L P L V I D Z U Q N P B O K V Y N M

ANGER
 CAKES
 EAT

GATHERED
 GLUTTON
 LORD

MANNA
 MEAT
 MOSES

PLAGUE
 QUAIL
 WRATH

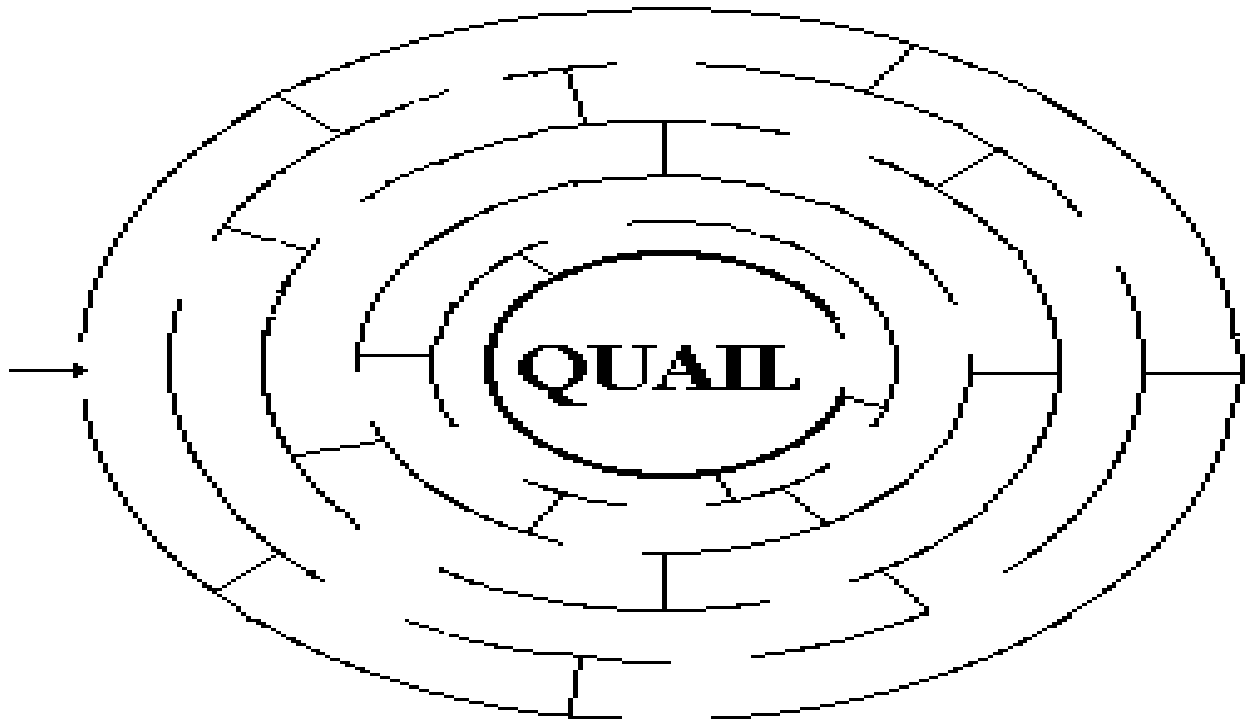

48. THE LORD SENDS QUAIL

(NUMBERS 11:4-14, 31-34)

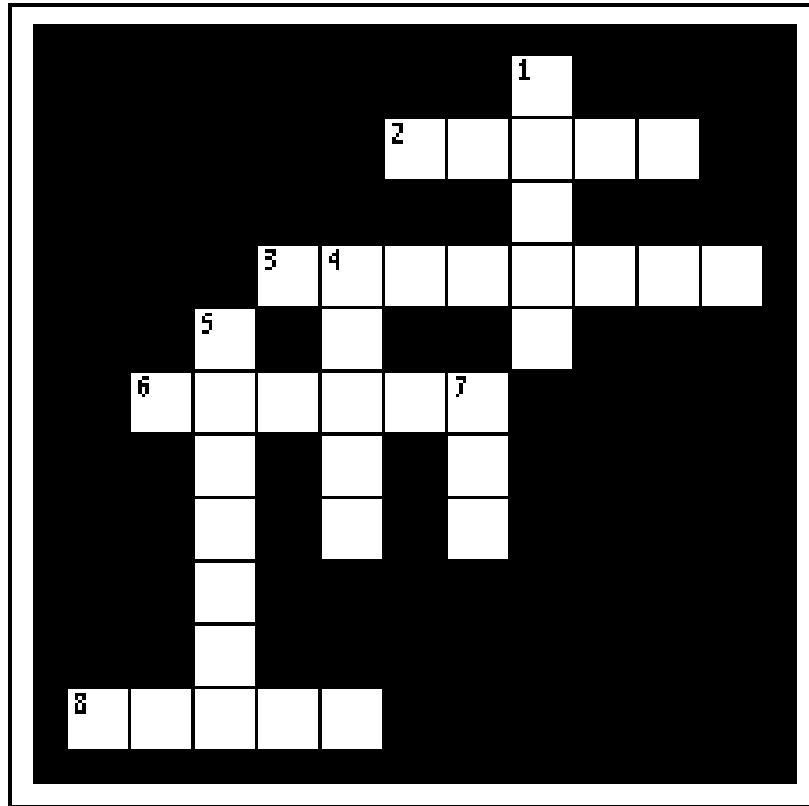

- 5 DOWN "For the drunkard and the _____ will come to poverty, and drowsiness will clothe a man with rags." **PROVERBS 23:21**
- 7 DOWN "The children of Israel also wept again and said, 'Who will give us meat to _____?' " **NUMBERS 11:4**
- 8 ACROSS They said, "But now our whole being is dried up; there is nothing at all except this _____ before our eyes!" **NUMBERS 11:6**
- 1 DOWN "The people went about and gathered it, ground it on millstones or beat it in the mortar, cooked it in pans, and made _____ of it." **NUMBERS 11:8**
- 4 DOWN "Now Moses heard the people weeping throughout their families, everyone at the door of his tent; and the _____ of the LORD was greatly aroused; Moses also was displeased." **NUMBERS 11:10**
- 2 ACROSS "Now a wind went out from the LORD, and it brought _____ from the sea and left them fluttering near the camp." **NUMBERS 11:31**
- 3 ACROSS "And the people stayed up all that day, all that night, and all the next day, and _____ the quail." **NUMBERS 11:32**
- 6 ACROSS "But while the meat was still between their teeth, before it was chewed, the wrath of the LORD was aroused against the people, and the LORD struck the people with a very great _____." **NUMBERS 11:33**

Bible Story 49

THE TWELVE SPIES

NUMBERS 13:1-14:9

49. THE TWELVE SPIES (NUMBERS 13:1-14:9)

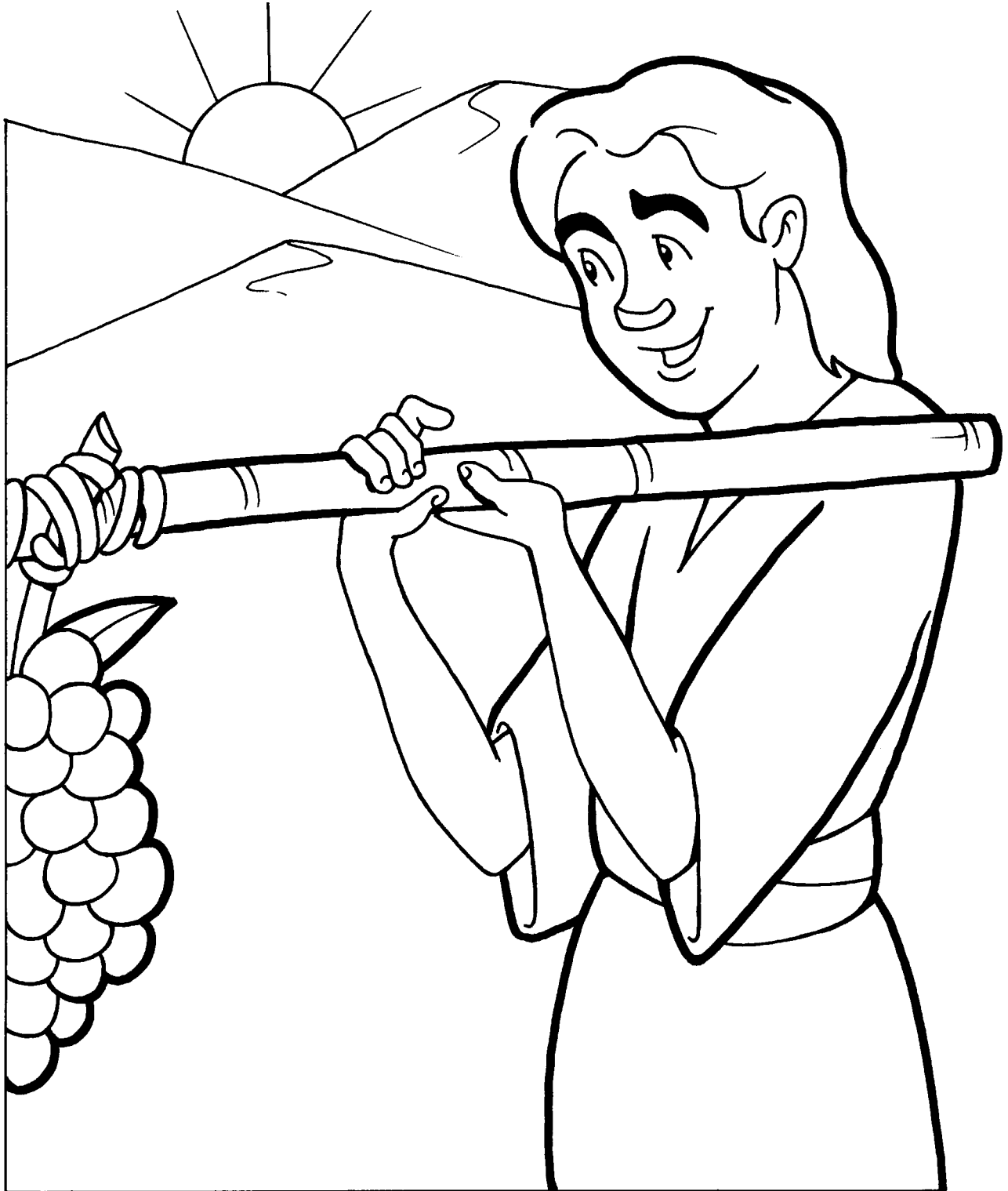

"And they came unto the brook of Eshcol, and cut down from thence a branch with one cluster of grapes, and they bare it between two upon a staff; and *they brought* of the pomegranates, and of the figs."

NUMBERS 13:23

49. THE TWELVE SPIES

(NUMBERS 13:1-14:9)

MEMORY VERSE:

"If the LORD delights in us, then He will bring us into this land and give it to us, 'a land which flows with milk and honey.'" NUMBERS 14:8

"And the LORD spoke to Moses saying..."

FILL IN THE BLANKS:

1. "Send men to spy out the land of Canaan, which ___ ___ _____ to the children of Israel; from each tribe of their fathers you shall send a _____ man, every one a leader among them." **NUMBERS 13:2**

TRUE OR FALSE:

2. But Moses would not send them even though the LORD had commanded. **NUMBERS 13:3**
TRUE OR FALSE
3. "So they went up and spied out the land from the Wilderness of Zin as far as Rehob, near the entrance of Hamath." **NUMBERS 13:21**
TRUE OR FALSE

CIRCLE THE CORRECT WORDS:

4. "Then they came to the Valley of Eshcol, and there cut down a branch with one cluster of (**GRAPES, PEAS**); they carried it between the two of them on a pole. They also brought some of the pomegranates and figs." **NUMBERS 13:23**
5. "And they returned from spying out the land after (**FOUR, FORTY**) days." **NUMBERS 13:25**
6. Joshua and Caleb told Moses, "We went to the land where you sent us. It truly flows with milk and honey, and this is its (**FRUIT, VEGETABLES**). Nevertheless the people who dwell in the land are (**STRONG, WEAK**); the cities are fortified and very (**SMALL, LARGE**)." **NUMBERS 13:27-28**

TRUE OR FALSE:

7. "But the men who had gone up with him said, 'We are not able to go up against the people, for they are stronger than we.'" **NUMBERS 13:31**
TRUE OR FALSE

FILL IN THE BLANKS:

8. Joshua and Caleb said to the people, "Do not _____ against the LORD, nor _____ the people of the land, for they are our bread; their protection has departed from them, and the LORD is with us. Do not fear them." **NUMBERS 14:9**

49. THE TWELVE SPIES

(NUMBERS 13:1-14:9)

D Y L J Y L A I O A T J A W P
 D O M K S C D E L I G H T S I
 Z L L G A T Z T B F D T Y P Y
 Z I E N R P N A H F T I U R F
 M A A B J A E A F T D A Q N B
 O A Q I E U S L I Q Q A U K B
 N V D C T R A S V G C U Q B P
 W C S N A T M U H S U E T C P
 H G Q C A L D B H O E N H D Y
 Q A R T N L E Z I S P I T W F
 I L V A L N W B O H O P P K O
 L O P C P O Q Z N A J J E S J
 H Z B J A E R N H U K Q T R W
 H O N E Y D S D I U S M R I S
 T M Q W S R M K U T M N R E S

CALEB
 CANAAN
 DELIGHTS
 FRUIT

GIANTS
 GRAPES
 GRASSHOPPERS
 HONEY

JOSHUA
 LAND
 LORD

MILK
 REBEL
 SPIES



49. THE TWELVE SPIES

(NUMBERS 13:1-14:9)

MEMORY VERSE:

"If the LORD delights in us, then He will bring us into this land and give it to us, 'a land which flows with milk and honey.'" NUMBERS 14:8

"And the LORD spoke to Moses saying..."

FILL IN THE BLANKS:

1. "Send men to spy out the land of Canaan, which ___ ___ _____ to the children of Israel; from each tribe of their fathers you shall send a man, every one a leader among them." **NUMBERS 13:2**

TRUE OR FALSE:

2. But Moses would not send them even though the LORD had commanded. **NUMBERS 13:3**
TRUE OR FALSE
3. "So they went up and spied out the land from the Wilderness of Zin as far as Rehob, near the entrance of Hamath." **NUMBERS 13:21**
TRUE OR FALSE

FILL IN THE BLANKS:

4. "Then they came to the Valley of Eshcol, and there cut down a branch with one cluster of _____; they carried it between the two of them on a pole. They also brought some of the pomegranates and figs." **NUMBERS 13:23**
5. "And they returned from spying out the land after _____ days." **NUMBERS 13:25**
6. Joshua and Caleb told Moses, "We went to the land where you sent us. It truly flows with milk and honey, and this is its _____. Nevertheless the people who dwell in the land are _____; the cities are fortified and very _____." **NUMBERS 13:27-28**

TRUE OR FALSE:

7. "But the men who had gone up with him said, 'We are not able to go up against the people, for they are stronger than we.'" **NUMBERS 13:31**
TRUE OR FALSE

FILL IN THE BLANKS:

8. Joshua and Caleb said to the people, "Do not _____ against the LORD, nor _____ the people of the land, for they are our bread; their protection has departed from them, and the LORD is with us. Do not fear them." **NUMBERS 14:9**

49. THE TWELVE SPIES

(NUMBERS 13:1-14:9)

J H Y L F Y E E I G C R D A U R U F Q J
 U Q T N A J T B F P L E O M V C I Q O B
 X U E D B N L D B C P L O P F G P S J A
 K F Z C F D M V L V R V K S I O H P J S
 B U Q R R Y E S T N A I G Y U U Q H C P
 D M U V R I Z N A U E F P L A W B M X W
 C I V O E S I P E I O T R F H J V G V J
 T N L N W B R Y Z R M E Z L I V B Q D H
 Z V S A G L I E T P B O S K P H D W I N
 R S R A F O D Y P E H J T I K E W G M F
 D L S N Z U D G L P Y Q V Q L Y D L O G
 Y B B A A A Z N C N O L G I R G R W O I
 Q C B C Y P P W L S Y H G S E M O D F E
 Q M A S N W Z Y W C M H S S N P L I U G
 H I Z L S C V Z C N T P W S A U Y C D W
 S O F S E P U U A S B V D O A V U P I L
 F E W K H B S E P A R G K E I R K L V A
 O M I L U R D G Z P P G A Z P E G O E N
 I K N P S F W F S C R Y G P Q Z Y P M D
 H E Y D S M E Y D X Y Q S E F U H D N K

CALEB
 CANAAN
 DELIGHTS
 FORTY DAYS

FRUIT
 GIANTS
 GRAPES

GRASSHOPPERS
 JOSHUA
 LAND

LORD
 REBEL
 SPIES



49. THE TWELVE SPIES

(NUMBERS 13:1-14:9)

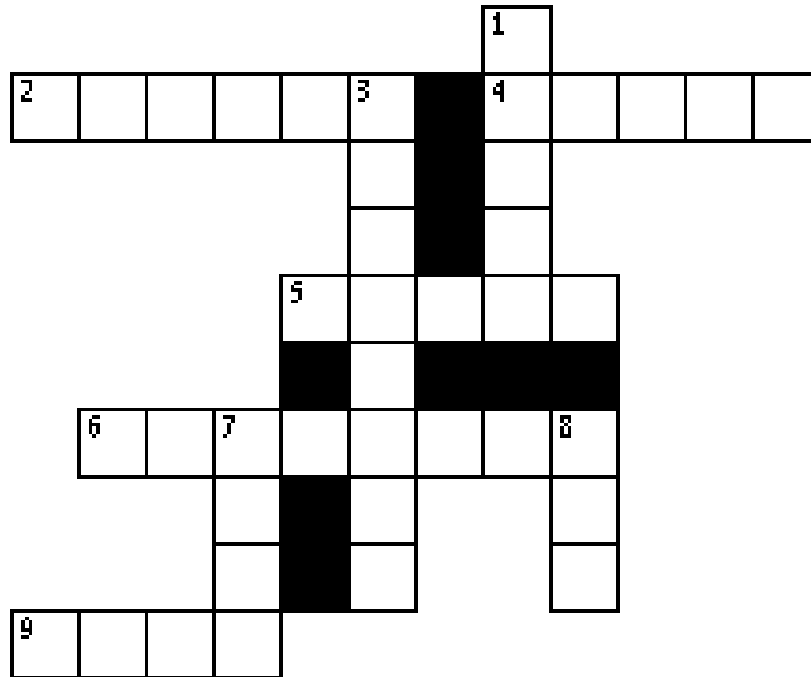

- 6 ACROSS "If the LORD _____ in us, then He will bring us into this land and give it to us, 'a land which flows with milk and honey.'" **NUMBERS 14:8**
- 8 DOWN "Send men to _____ out the land of Canaan, which I am giving to the children of Israel; from each tribe of their fathers you shall send a man, every one a leader among them." **NUMBERS 13:2**
- 7 DOWN "So Moses sent them up from the Wilderness of Paran according to the command of the _____." **NUMBERS 13:3**
- 9 ACROSS "So they went up and spied out the _____ from the Wilderness of Zin as far as Rehob, near the entrance of Hamath." **NUMBERS 13:21**
- 2 ACROSS "Then they came to the Valley of Eshcol, and there cut down a branch with one cluster of _____ they carried it between the two of them on a pole. They also brought some of the pomegranates and figs." **NUMBERS 13:23**
- 5 ACROSS "And they returned from spying out the land after _____ days." **NUMBERS 13:25**
- 1 DOWN Joshua and Caleb told Moses, "We went to the land where you sent us. It truly flows with milk and honey, and this is its _____. Nevertheless the people who dwell in the land are strong; the cities are fortified and very large." **NUMBERS 13:27-28**
- 3 DOWN "But the men who had gone up with him said, 'We are not able to go up against the people, for they are _____ than we.'" **NUMBERS 13:31**
- 4 ACROSS Joshua and Caleb said to the people, "Do not _____ against the LORD, nor fear the people of the land, for they are our bread; their protection has departed from them, and the LORD is with us. Do not fear them." **NUMBERS 14:9**

Bible Story 50

**WANDERING IN
THE WILDERNESS**

NUMBERS 14:11-35

50. WANDERING IN THE WILDERNESS

(NUMBERS 14:11-38)



"After the number of the days in which ye searched the land, *even* forty days, each day for a year, shall ye bear your iniquities, *even* forty years, and ye shall know my breach of promise."

NUMBERS 14:34

50. WANDERING IN THE WILDERNESS

(NUMBERS 14:11-38)

MEMORY VERSE:

"The LORD is longsuffering and abundant in mercy, forgiving iniquity and transgression." NUMBERS 14:18

CIRCLE THE CORRECT WORD:

1. "The LORD said to Moses: 'How long will these people (**REJECT, RESPECT**) Me? And how long will they not believe Me, with all the signs which I have performed among them?' "
NUMBERS 14:11

FILL IN THE BLANKS:

2. The LORD said, "The carcasses of you who have murmured against Me shall fall in this _____, all of you who were numbered, according to your entire number, from _____ years old and _____ above." NUMBERS 14:29

TRUE OR FALSE:

3. The LORD also said, "Except for Caleb the son of Jephunneh and Joshua the son of Nun, you shall by no means enter the land which I swore I would make you dwell in." NUMBERS 14:30
TRUE OR FALSE
4. Then He said, "Neither shall your little ones enter in, nor will they know the land which you have despised." NUMBERS 14:31
TRUE OR FALSE

CIRCLE THE CORRECT WORDS:

5. "According to the number of days in which you (**FARMED, SPIED**) out the land, forty days, for each day you shall bear your guilt one year, namely forty years, and you shall know My rejection." NUMBERS 14:34
6. "I the LORD have spoken this; I will surely do so to all this evil congregation who are gathered together against Me. In this wilderness they shall be consumed, and there they shall (**LIVE, DIE**)." NUMBERS 14:35
7. "Those very men who brought the evil report about the land, died by the (**PLAGUE, SWORD**) before the LORD. But Joshua the son of Nun and Caleb the son of Jephunneh remained (**CALM, ALIVE**), of the men who went to spy out the land." NUMBERS 14:37-38

50. WANDERING IN THE WILDERNESS

(NUMBERS 14:11-38)

W A N D E R I N G D
I I W O E Y U V Q E
F R L P J L O R D S
E O O D M O S E S P
N R R E E T G S T I
T W I T E R H U P S
E G U P Y I N B L E
R E J E C T D E J D
I T M K F W R H S J
B K F L A N D U B S

DESPISED
DIE
ENTER

FORTY
LAND
LORD

MOSES
REJECT
REPORT

WANDERING
WILDERNESS

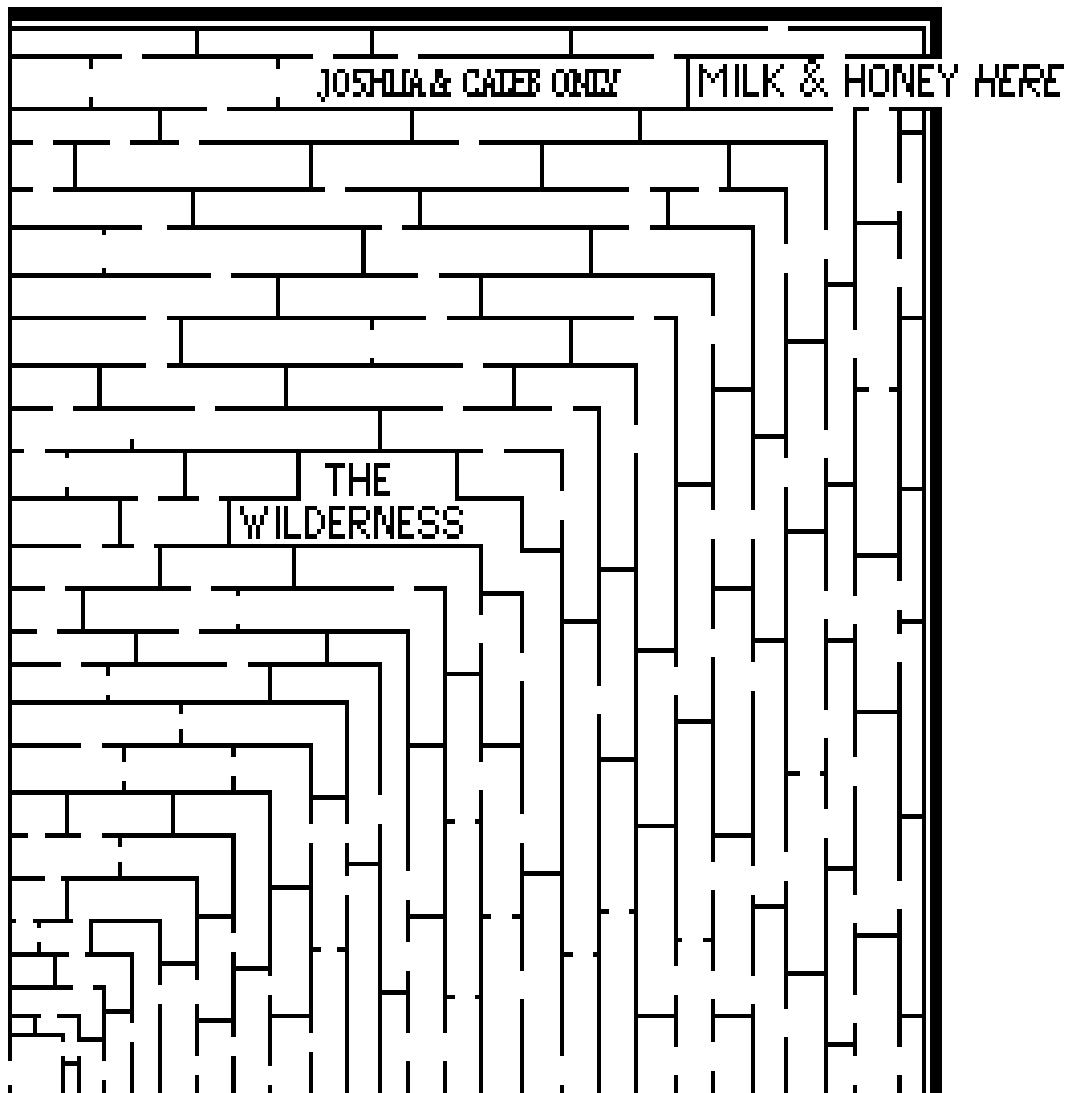

50. WANDERING IN THE WILDERNESS

(NUMBERS 14:11-38)

MEMORY VERSE:

"The LORD is longsuffering and abundant in mercy, forgiving iniquity and transgression." NUMBERS 14:18

FILL IN THE BLANKS:

1. "The LORD said to Moses: 'How long will these people _____ Me? And how long will they not believe Me, with all the signs which I have performed among them?' " **NUMBERS 14:11**
2. The LORD said, "The carcasses of you who have murmured against Me shall fall in this _____, all of you who were numbered, according to your entire number, from _____ years old and above." **NUMBERS 14:29**

TRUE OR FALSE:

3. The LORD also said, "Except for Caleb the son of Jephunneh and Joshua the son of Nun, you shall by no means enter the land which I swore I would make you dwell in." **NUMBERS 14:30**
TRUE OR FALSE
4. Then He said, "Neither shall your little ones enter in, nor will they know the land which you have despised." **NUMBERS 14:31**
TRUE OR FALSE

FILL IN THE BLANKS:

5. "According to the number of days in which you _____ out the land, forty days, for each day you shall bear your guilt one year, namely forty years, and you shall know My rejection." **NUMBERS 14:34**
6. "I the LORD have spoken this; I will surely do so to all this evil congregation who are gathered together against Me. In this wilderness they shall be consumed, and there they shall _____." **NUMBERS 14:35**

CIRCLE THE CORRECT WORDS:

7. "Those very men who brought the evil report about the land, died by the (PLAGUE, SWORD) before the LORD. But Joshua the son of Nun and Caleb the son of Jephunneh remained (CALM, ALIVE), of the men who went to spy out the land." **NUMBERS 14:37-38**

50. WANDERING IN THE WILDERNESS

(NUMBERS 14:11-38)

P N C Z P P B V G Z A L U N J
 Z W L S D R F O R T Y K V A V
 V Y W I N E P T Y S G I F I H
 U Z E D S G N I R E D N A W Y
 D U C G S C A L E B S Q I P G
 W G D P R S R O Q T A S U Q M
 E F E C C E E J D J O S H U A
 E Y S L N M P N O V U S H F L
 B I I A P H Y O R G K D I R U
 D F P N S T R Q R E S O R C V
 V B S D C E C L O T D E P O E
 N L E V L Y S E K W Y L K G L
 P A D U C Y E O J D P Z I O Z
 Y E A I M M P P M E F P R W U
 G Z R E T N E V P K R E E W U

CALEB
 DESPISED
 DIE
 ENTER

FORTY
 JOSHUA
 LAND

LORD
 MOSES
 REJECT

REPORT
 WANDERING
 WILDERNESS

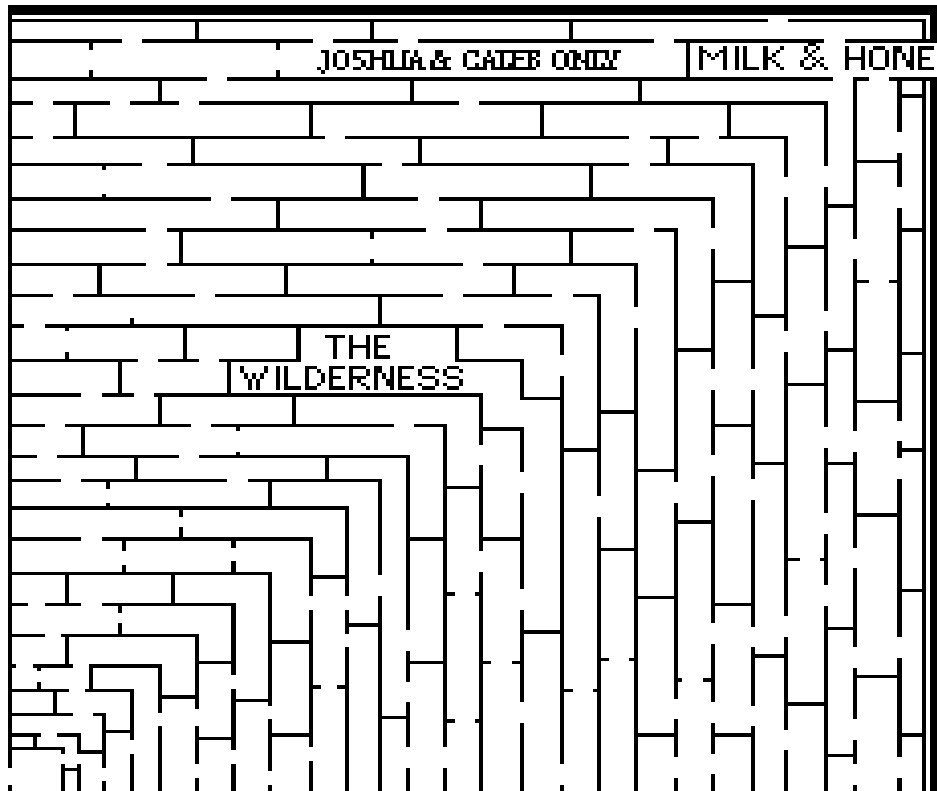

BEGIN HERE
 YOU REBEL →

50. WANDERING IN THE WILDERNESS

(NUMBERS 14:11-38)

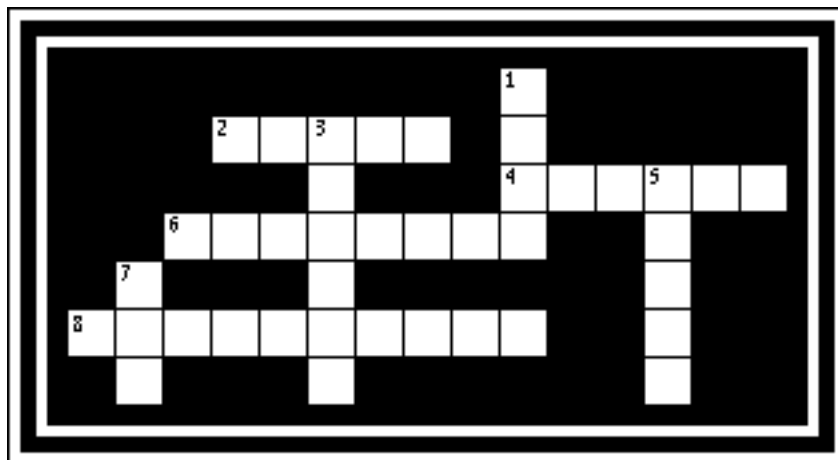

- 1 DOWN "The _____ is longsuffering and abundant in mercy, forgiving iniquity and transgression." **NUMBERS 14:18**
- 4 ACROSS "The LORD said to Moses: 'How long will these people _____ Me? And how long will they not believe Me, with all the signs which I have performed among them?' " **NUMBERS 14:11**
- 8 ACROSS The LORD said, "The carcasses of you who have murmured against Me shall fall in this _____, all of you who were numbered, according to your entire number, from twenty years old and above." **NUMBERS 14:29**
- 5 DOWN The LORD also said, "Except for Caleb the son of Jephunneh and Joshua the son of Nun, you shall by no means _____ the land which I swore I would make you dwell in." **NUMBERS 14:30**
- 6 ACROSS "Then He said, "But your little ones, whom you said would be victims , I will bring in, and they shall know the land which you have _____." **NUMBERS 14:31**
- 2 ACROSS "According to the number of days in which you spied out the land, forty days, for each day you shall bear your guilt one year, namely _____ years, and you shall know My rejection." **NUMBERS 14:34**
- 7 DOWN "I the LORD have spoken this; I will surely do so to all this evil congregation who are gathered together against Me. In this wilderness they shall be consumed, and there they shall _____." **NUMBERS 14:35**
- 3 DOWN "Those very men who brought the evil _____ about the land, died by the plague before the LORD. But Joshua the son of Nun and Caleb the son of Jephunneh remained alive, of the men who went to spy out the land." **NUMBERS 14:37-38**

Bible Story 51

**MOSES
DISOBEYS GOD**

NUMBERS 20:1-13

51. MOSES DISOBEYS GOD

(NUMBERS 20:1-13)



"Behold, to obey is better than sacrifice."
1 SAMUEL 15:22

51. MOSES DISOBEYS GOD

(NUMBERS 20:1-13)

MEMORY VERSE:

"Behold, to obey is better than sacrifice." 1 SAMUEL 15:22

"Then the children of Israel, the whole congregation, came into the Wilderness of Zin in the first month, and the people stayed in Kadesh;" NUMBERS 20:1

TRUE OR FALSE:

1. "Miriam died there and was buried there." NUMBERS 20:1
TRUE OR FALSE
2. Now there was plenty of water there; so they gathered together against Moses and Aaron. NUMBERS 20:2
TRUE OR FALSE

CIRCLE THE CORRECT WORDS:

3. The people cried to Moses and Aaron, "Why have you brought up the congregation of the LORD into this wilderness, that we and our animals should (LIVE, DIE) here?" NUMBERS 20:4

"The LORD spoke to Moses, saying..."
4. "Take the rod; you and your brother Aaron gather the assembly together. (SPEAK, STRIKE) to the rock before their eyes, and it will yield its water; thus you shall bring water for them out of the rock, and give drink to the congregation and their animals." NUMBERS 20:8
5. "Moses and Aaron gathered the congregation together before the rock; and he said to them, 'Hear now, you rebels! Must we bring water for you out of this (WELL, ROCK)?' "
NUMBERS 20:10

FILL IN THE BLANKS:

6. "Then Moses lifted his hand and _____ the rock twice with his rod; and water came out abundantly, and the congregation and their animals drank." NUMBERS 20:11
7. "Then the LORD spoke to Moses and Aaron, 'Because you did not believe Me, to _____ Me in the eyes of the children of Israel, therefore you shall not bring this congregation into the land which I have given them.' " NUMBERS 20:12

CIRCLE THE CORRECT WORD:

8. "This was the water of Meribah, because the children of Israel (CONTENDED, DINED) with the LORD, and He was hallowed among them." NUMBERS 20:13

51. MOSES DISOBEYS GOD

(NUMBERS 20:1-13)

K	A	E	P	S	D	S	W	O	H
B	T	K	O	R	J	T	A	F	D
R	W	O	L	L	A	H	T	V	O
B	E	C	T	P	Q	E	E	G	G
M	J	T	A	I	R	I	R	S	M
K	C	U	R	T	S	D	S	V	P
E	Z	I	N	Q	I	F	E	M	S
L	K	C	O	R	L	A	S	A	V
M	I	R	I	A	M	Y	O	Z	O
J	Z	Y	E	B	O	Y	M	S	J

DIE
GOD
HALLOW
MIRIAM

MOSES
OBEY
ROCK

SPEAK
STRUCK
WATER

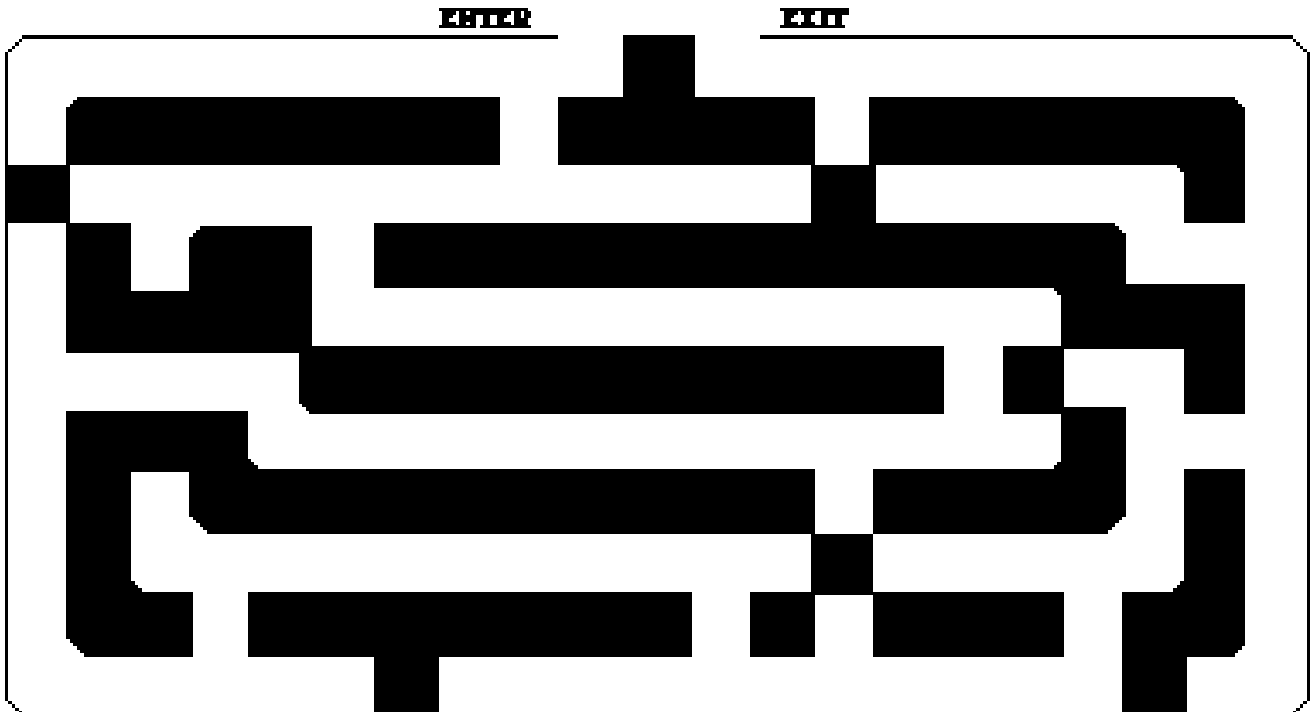

51. MOSES DISOBEYS GOD

(NUMBERS 20:1-13)

MEMORY VERSE:

"Behold, to obey is better than sacrifice." 1 SAMUEL 15:22

"Then the children of Israel, the whole congregation, came into the Wilderness of Zin in the first month, and the people stayed in Kadesh;" NUMBERS 20:1

TRUE OR FALSE:

1. "Miriam died there and was buried there." NUMBERS 20:1
TRUE OR FALSE
2. Now there was plenty of water there; so they gathered together against Moses and Aaron. NUMBERS 20:2
TRUE OR FALSE

FILL IN THE BLANKS:

3. The people cried to Moses and Aaron, "Why have you brought up the congregation of the LORD into this wilderness, that we and our animals should _____ here?" NUMBERS 20:4

"The LORD spoke to Moses, saying..."
4. "Take the rod; you and your brother Aaron gather the assembly together. _____ to the rock before their eyes, and it will yield its water; thus you shall bring water for them out of the rock, and give drink to the congregation and their animals." NUMBERS 20:8
5. "Moses and Aaron gathered the congregation together before the rock; and he said to them, 'Hear now, you rebels! Must we bring _____ for you out of this _____?' " NUMBERS 20:10
6. "Then Moses lifted his hand and _____ the rock twice with his rod; and water came out abundantly, and the congregation and their animals drank." NUMBERS 20:11
7. "Then the LORD spoke to Moses and Aaron, 'Because you did not believe Me, to _____ Me in the eyes of the children of Israel, therefore you shall not bring this congregation into the land which I have given them.' " NUMBERS 20:12

CIRCLE THE CORRECT WORD:

8. "This was the water of Meribah, because the children of Israel (**CONTENDED, DINED**) with the LORD, and He was hallowed among them." NUMBERS 20:13

51. MOSES DISOBEYS GOD

(NUMBERS 20:1-13)

P V P G L V I L V J L M Z I D
 U G M D M W S T R U C K Z U Q
 Y S B C A A L O P W P D N A C
 M S E T O D I G O D Y E B O U
 K N E S K N H R B Y U W K L J
 T R B P O D T Z I J T Q O M K
 G B O K W M H E Q M N X B T S
 E K H S V Z T S N K D I H Q M
 Y S S P H Z Y M E D C T F H J
 G K P P J A O F J D E O V A T
 M O S E N O L M I T A D R U A
 Q J R R A W A L C N R K I U A
 H Q V L W K V Q O A A A O T U
 D I E O E H C S T W Z L N T E
 V S N S L Q A Q C S E B H D N

CONTENDED
 DIE
 GOD
 HALLOW

KADESH
 MIRIAM
 MOSES
 OBEY

ROCK
 SPEAK
 STRUCK
 WATER

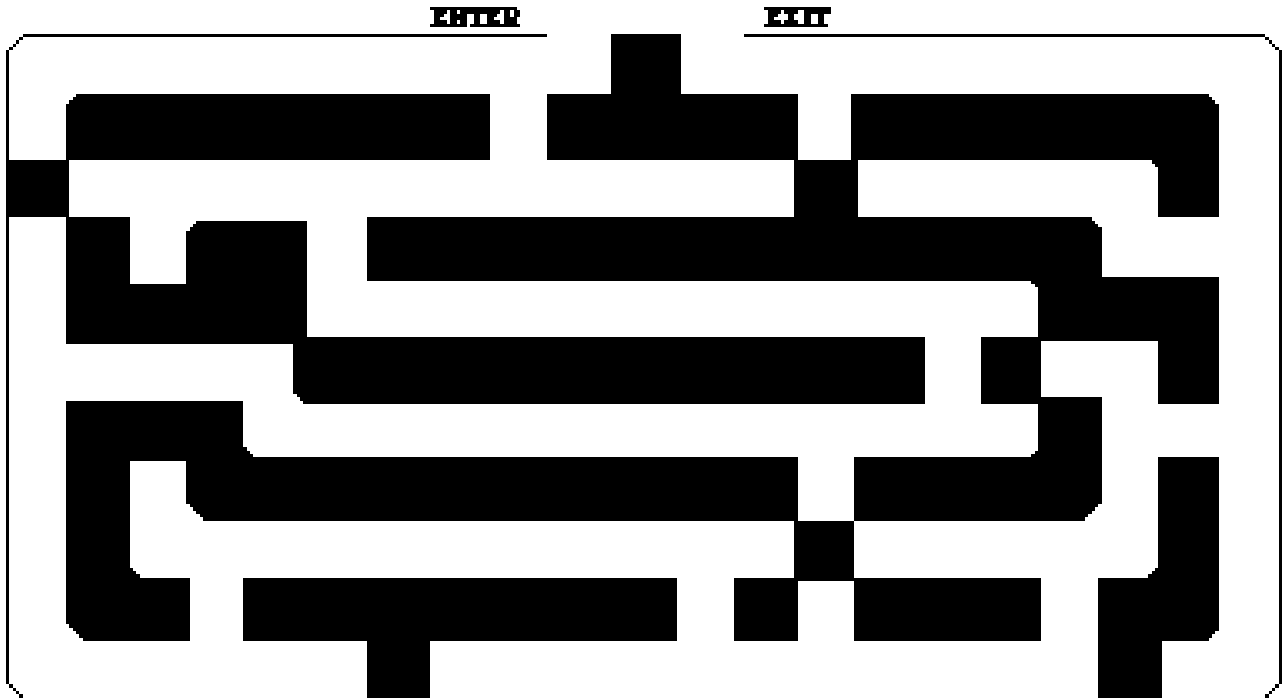

51. MOSES DISOBEYS GOD

(NUMBERS 20:1-13)

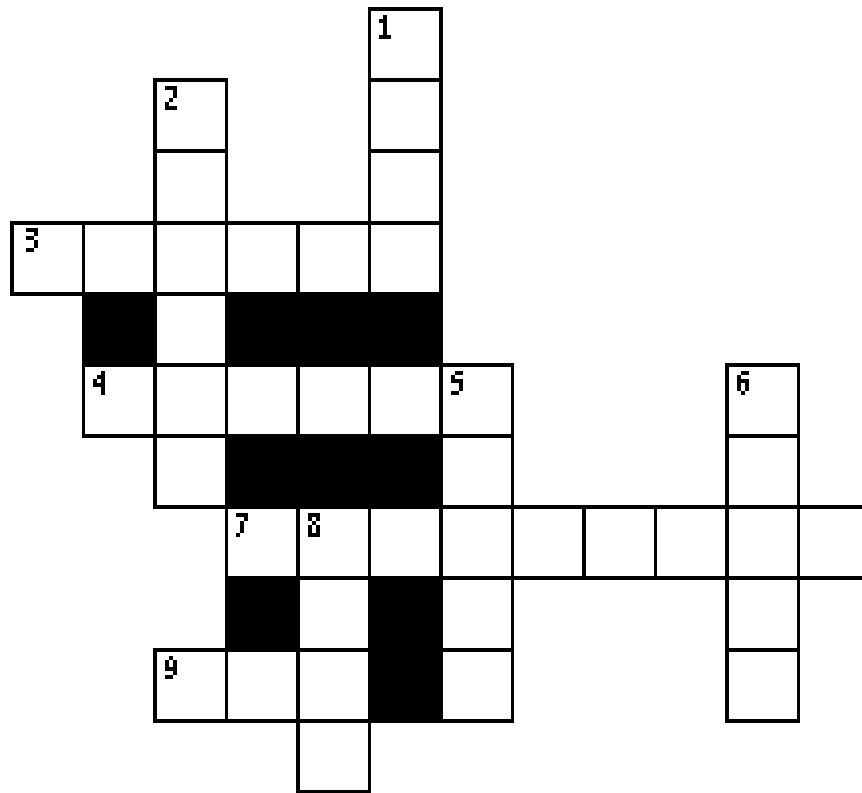

- 8 DOWN "Behold, to _____ is better than sacrifice." **1 SAMUEL 15:22**
- 2 DOWN "_____ died there and was buried there." **NUMBERS 20:1**
- 5 DOWN "Now there was no _____ for the congregation; so they gathered together against Moses and Aaron." **NUMBERS 20:2**
- 9 ACROSS The people cried to Moses and Aaron, "Why have you brought up the congregation of the LORD into this wilderness, that we and our animals should _____ here?" **NUMBERS 20:4**
- 6 DOWN "Take the rod; you and your brother Aaron gather the assembly together. _____ to the rock before their eyes, and it will yield its water; thus you shall bring water for them out of the rock, and give drink to the congregation and their animals." **NUMBERS 20:8**
- 1 DOWN "Moses and Aaron gathered the congregation together before the rock; and he said to them, 'Hear now, you rebels! Must we bring water for you out of this _____?' " **NUMBERS 20:10**
- 3 ACROSS "Then Moses lifted his hand and _____ the rock twice with his rod; and water came out abundantly, and the congregation and their animals drank." **NUMBERS 20:11**
- 4 ACROSS "Then the LORD spoke to Moses and Aaron, 'Because you did not believe Me, to _____ Me in the eyes of the children of Israel, therefore you shall not bring this congregation into the land which I have given them.' " **NUMBERS 20:12**
- 7 ACROSS "This was the water of Meribah, because the children of Israel _____ with the LORD, and He was hallowed among them." **NUMBERS 20:13**

Bible Story 52

**THE
BRONZE SERPENT**

NUMBERS 21:4-9

52. THE BRONZE SERPENT (NUMBERS 21:4-9)



"And the LORD sent fiery serpents among the people, and they bit the people; and much people of Israel died."

NUMBERS 21:6

52. THE BRONZE SERPENT (NUMBERS 21:4-9)

MEMORY VERSE:

"And as Moses lifted up the serpent in the wilderness, even so must the Son of Man be lifted up." JOHN 3:14

CIRCLE THE CORRECT WORD:

1. The children of Israel "journeyed from Mount Hor by the Way of the Red Sea, to go around the land of Edom; and the soul of the people became very (**DISCOURAGED, ENCOURAGED**) on the way." **NUMBERS 21:4**

FILL IN THE BLANKS:

2. "And the people spoke against _____ and against _____: 'Why have you brought us up out of Egypt to die in the wilderness? For there is no _____ and no _____, and our soul loathes this worthless _____.'" **NUMBERS 21:5**

CIRCLE THE CORRECT WORD:

3. "So the LORD sent fiery (**RATS, SERPENTS**) among the people, and they bit the people; and many of the people of Israel died." **NUMBERS 21:6**

TRUE OR FALSE:

4. "Therefore the people came to Moses, and said, 'We have sinned, for we have spoken against the LORD and against you; pray to the LORD that He take away the serpents from us.'" **NUMBERS 21:7**

TRUE OR FALSE

5. But Moses would not pray to the LORD for the people. **NUMBERS 21:7**

TRUE OR FALSE

CIRCLE THE CORRECT WORDS:

6. "Then the LORD said to Moses, 'Make a fiery serpent, and set it on a pole; and it shall be that everyone who is bitten, when he (**LOOKS, WORKS**) at it, shall live.'" **NUMBERS 21:8**
7. "So Moses made a bronze serpent, and put it on a pole; and so it was, if a serpent had bitten anyone, when he looked at the bronze serpent, he (**LIVED, DIED**).'" **NUMBERS 21:9**

52. THE BRONZE SERPENT

(NUMBERS 21:4-9)

B D E K O O L H C R K Q L V J
Y U H H L P I A C B C D S M E
N W N Z N J O W Q D R J T A A
M L O R D T V N E B E E F Z W
H J S E H T A O L Z T N A S L
L N G I V B Q P I K N Q N D Z
M S N V Q I Z E W E I O A I E
O Z G V T A U S Z F O R R H S
S D E G A R U O C S I D Y B M
E K R B A M A G K J T E Y M P
S B Q Q Q G N D K T A Y O L J
D Z I Y F T M E Q E N A F S H
S E R P E N T S J J R R V V G
R F P E H Y G P B Z P P M O E
E E L O P L F Z B Z I I S J U

BREAD
BRONZE
DISCOURAGED
LOATHES

LOOKED
LORD
MOSES
POLE

PRAYED
SERPENTS
SINNED

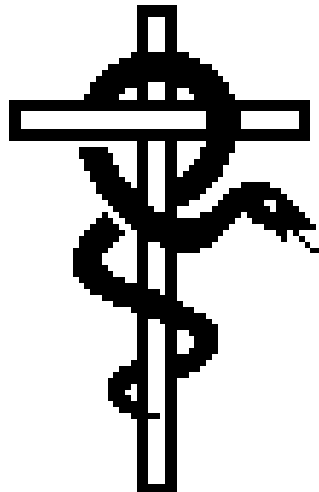

52. THE BRONZE SERPENT

(NUMBERS 21:4-9)

MEMORY VERSE:

"And as Moses lifted up the serpent in the wilderness, even so must the Son of Man be lifted up." JOHN 3:14

FILL IN THE BLANKS:

1. The children of Israel "journeyed from Mount Hor by the Way of the Red Sea, to go around the land of Edom; and the soul of the people became very _____ on the way." **NUMBERS 21:4**
2. "And the people spoke against _____ and against _____: 'Why have you brought us up out of Egypt to die in the wilderness? For there is no _____ and no _____, and our soul loathes this worthless _____.'" **NUMBERS 21:5**
3. "So the LORD sent fiery _____ among the people, and they bit the people; and many of the people of Israel died." **NUMBERS 21:6**

UNDERLINE THE CORRECT ANSWER:

4. "Therefore the people came to Moses, and said,..." **NUMBERS 21:7**
 - a. we have sinned
 - b. we have spoken against the LORD and against you
 - c. pray to the LORD that He take away the serpents from us
 - d. all of the above

TRUE OR FALSE:

5. But Moses would not pray to the LORD for the people. **NUMBERS 21:7**
TRUE OR FALSE

CIRCLE THE CORRECT WORD:

6. "Then the LORD said to Moses, 'Make a fiery serpent, and set it on a pole; and it shall be that everyone who is bitten, when he (**LOOKS, WORKS**) at it, shall live.'" **NUMBERS 21:8**

FILL IN THE BLANK:

7. "So Moses made a bronze serpent, and put it on a pole; and so it was, if a serpent had bitten anyone, when he looked at the bronze serpent, he _____." **NUMBERS 21:9**

52. THE BRONZE SERPENT

(NUMBERS 21:4-9)

G E P R Z Z J Z B A J Q K S G C S F W D
 M Y M X O M W E H U T T I S D C V L Q Y
 B G B D W F D M F P R A Y E D H Y Y N S
 P M R O D M Y E V U A H E I V R K H I M
 M O B S H I J D N T A T P E V I L P S U
 L Q O L Q Q S W I N U T I A D E K O O L
 W H H K I S T C O T I R Y G B E W O V X
 N V S W L Q N Q O D E S B W G S L I U S
 G V S P O L E L S U N R B A E E W R U E
 K G R V H V A I N E R W P Z C H W F A J
 B B V J T P S T H D S A N F Z T Z Y D M
 Y S R N Y S L A I Q Q O G U H A O X D G
 K N N E O B E L U C R P M E K O A D W O
 P B G W A Q P R A B P N P T D L K P T V
 U P D E A D U B P L N K Y O K M M B L S
 Y R P L V J T Z F E A B F M R Q N E A P
 F O G V C I N Z F J N C O J E N U H O T
 S J S D A C D N T N Y T J K N Y D T A W
 T Q P D L T R K Q S Q D S G C M L L P B
 G S P Z O C A O H M U W W H V A U U A H

BREAD
 BRONZE
 DISCOURAGED
 LIVE

LOATHES
 LOOKED
 LORD
 MOSES

POLE
 PRAYED
 SERPENTS
 SINNED

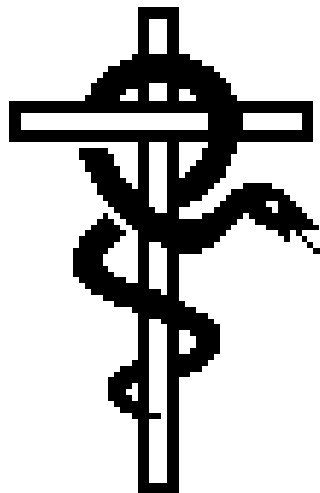

52. THE BRONZE SERPENT (NUMBERS 21:4-9)

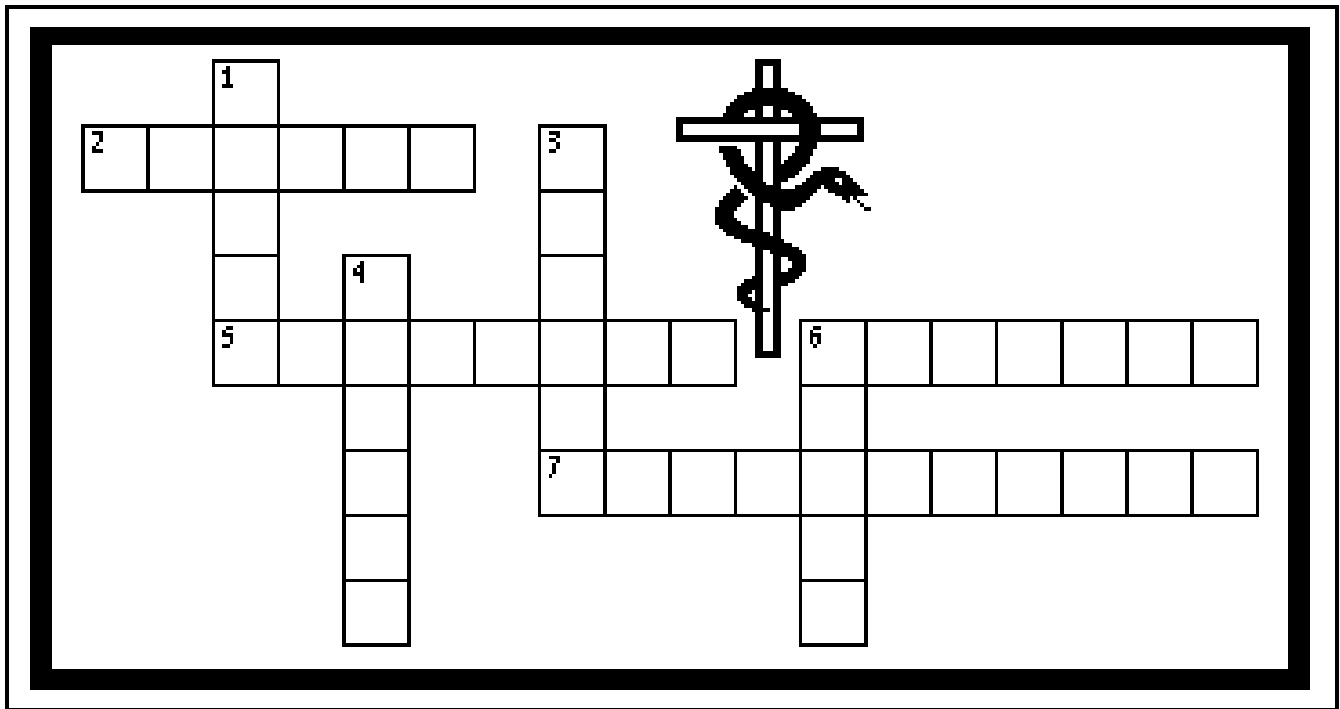

- 1 DOWN "And as _____ lifted up the serpent in the wilderness, even so must the Son of Man be lifted up." **JOHN 3:14**
- 7 ACROSS The children of Israel "journeyed from Mount Hor by the Way of the Red Sea, to go around the land of Edom; and the soul of the people became very _____ on the way." **NUMBERS 21:4**
- 6 ACROSS "And the people spoke against God and against Moses: 'Why have you brought us up out of Egypt to die in the wilderness? For there is no food and no water, and our soul _____ this worthless bread.'" **NUMBERS 21:5**
- 5 ACROSS "So the LORD sent fiery _____ among the people, and they bit the people; and many of the people of Israel died." **NUMBERS 21:6**
- 3 DOWN "Therefore the people came to Moses, and said, 'We have _____ for we have spoken against the LORD and against you; pray to the LORD that He take away the serpents from us.'" **NUMBERS 21:7**
- 4 DOWN "So Moses _____ for the people." **NUMBERS 21:7**
- 6 DOWN "Then the LORD said to Moses, 'Make a fiery serpent, and set it on a pole; and it shall be that everyone who is bitten, when he _____ at it, shall live.'" **NUMBERS 21:8**
- 2 ACROSS "So Moses made a _____ serpent, and put it on a pole; and so it was, if a serpent had bitten anyone, when he looked at the bronze serpent, he lived." **NUMBERS 21:9**

Bible Story 53

BALAAM

NUMBERS 22-24

53. BALAAM
(NUMBERS 22-24)



"And the LORD opened the mouth of the donkey, and she said unto Balaam, What have I done unto thee, that thou hast smitten me these three times?"

NUMBERS 22:28

53. BALAAM

(NUMBERS 22-24)

MEMORY VERSE:

"He was rebuked for his iniquity; a dumb donkey speaking with a man's voice restrained the madness of the prophet." 2 PETER 2:16

TRUE OR FALSE:

1. "The children of Israel moved ,and camped in the plains of Moab on the side of the Jordan across from Jericho." **NUMBERS 22:1**

TRUE OR FALSE

FILL IN THE BLANK:

2. Now Balak "sent messengers to Balaam the son of Beor at Pethor, which is near the River in the land of the sons of his people, to call him, saying: 'Look, a people has come from Egypt. See, they _____ the face of the earth, and are settling next to me!' " **NUMBERS 22:5**

UNDERLINE THE CORRECT ANSWER:

3. Balaam was asked, "Please come at once, curse this people for me, for they are too mighty for me. Perhaps I shall be able to defeat them and drive them out of the land, for I know that..."**NUMBERS 22:6**
 - a. he whom you bless is blessed
 - b. and he whom you curse is cursed
 - c. both of these answers
4. "God said to Balaam..." **NUMBERS 22:12**
 - a. You shall not go with them
 - b. You shall not curse the people
 - c. They are blessed
 - d. all of the above

FILL IN THE BLANK:

5. When Balaam did go, "God's anger was aroused because he went, and the _____ of the LORD took his stand in the way as an adversary against him. And he was riding on his donkey, and his two servants were with him." **NUMBERS 22:22**

CIRCLE THE CORRECT WORDS:

6. "When the donkey saw the Angel of the LORD, she lay down under Balaam; so Balaam's anger was aroused, and he (**STRUCK, TICKLED**) the donkey with his staff." **NUMBERS 22:27**
7. "The LORD opened the mouth of the (**MONKEY, DONKEY**), and she said to Balaam, 'What have I done to you, that you have struck me these three times?' " **NUMBERS 22:28**
8. The Angel of the LORD said to Balaam, "The donkey saw Me and turned aside from Me these (**THIRTY, THREE**) times. If she had not turned aside from Me, surely I would also have killed you by now." **NUMBERS 22:33**

TRUE OR FALSE:

9. "The Angel of the LORD said to Balaam, 'Go with the men, but only the word that I speak to you, that you shall speak.' " **NUMBERS 22:35**

TRUE OR FALSE

10. "Balak's anger was aroused against Balaam, and he struck his hands together; and Balak said to Balaam, 'I called you to curse my enemies, and look, you have bountifully blessed them these three times.'" **NUMBERS 24:10**

TRUE OR FALSE

53. BALAAM

(NUMBERS 22-24)

P S C E H I Q B Q M I F L Q Y
R S F U N V T I Z P W J C R Y
O I K W G V A A U E Z T T Y O
P L B J G B M A A L A B I E F
H S D E S S E L B S K E O K V
E J Y N G Q Q M A G K J T N L
T L N S R Y F X N D Q Z A O S
K L M Z Q E H T M E J Z N D V
T D R O L E H T F O L E G N A
D O H K I K A L A B B K R I M
Y P E S R U C Y G P B C P L T
H E L B P L P L F Z R U I S H
J E R I C H O I H C B R Q T R
U O D Z H N J O A C K T D F E
Q O R F Z V T V W Q E S J A E

ANGEL OF THE LORD
BALAAM
BALAK
BLESSED

CURSE
DONKEY
JERICHO

PROPHET
STRUCK
THREE

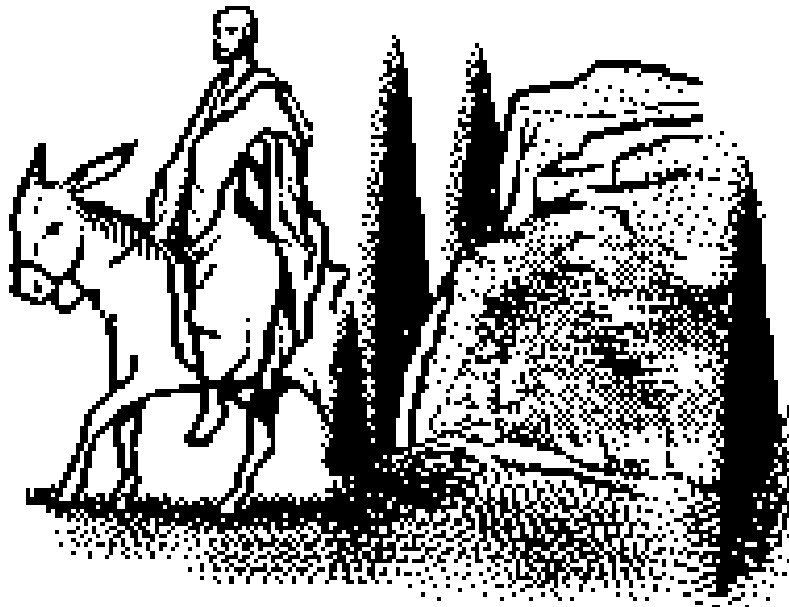

53. BALAAM

(NUMBERS 22-24)

MEMORY VERSE:

"He was rebuked for his iniquity; a dumb donkey speaking with a man's voice restrained the madness of the prophet." 2 PETER 2:16

FILL IN THE BLANKS:

1. "The children of Israel moved ,and camped in the plains of Moab on the side of the Jordan across from _____." **NUMBERS 22:1**
2. Now Balak "sent messengers to Balaam the son of Beor at Pethor, which is near the River in the land of the sons of his people, to call him, saying: 'Look, a people has come from Egypt. See, they _____ the face of the earth, and are settling next to me!' " **NUMBERS 22:5**

UNDERLINE THE CORRECT ANSWER:

3. Balaam was asked, "Please come at once, curse this people for me, for they are too mighty for me. Perhaps I shall be able to defeat them and drive them out of the land, for I know that..."**NUMBERS 22:6**
 - a. he whom you bless is blessed
 - b. and he whom you curse is cursed
 - c. both of these answers
4. "God said to Balaam..." **NUMBERS 22:12**
 - a. You shall not go with them
 - b. You shall not curse the people
 - c. They are blessed
 - d. all of the above

FILL IN THE BLANKS:

5. When Balaam did go, "God's anger was aroused because he went, and the _____ of the LORD took his stand in the way as an adversary against him. And he was riding on his donkey, and his two servants were with him." **NUMBERS 22:22**
6. "When the donkey saw the Angel of the LORD, she lay down under Balaam; so Balaam's anger was aroused, and he _____ the donkey with his staff." **NUMBERS 22:27**
7. "The LORD opened the mouth of the _____ and she said to Balaam, 'What have I done to you, that you have struck me these three times?' " **NUMBERS 22:28**
8. The Angel of the LORD said to Balaam, "The donkey saw Me and turned aside from Me these _____ times. If she had not turned aside from Me, surely I would also have killed you by now." **NUMBERS 22:33**

TRUE OR FALSE:

9. "The Angel of the LORD said to Balaam, 'Go with the men, but only the word that I speak to you, that you shall speak.' " **NUMBERS 22:35**

TRUE OR FALSE

FILL IN THE BLANKS:

10. "Balak's anger was aroused against Balaam, and he struck his hands together; and Balak said to Balaam, 'I called you to _____ my enemies, and look, you have bountifully _____ them these three times.'" **NUMBERS 24:10**

53. BALAAM

(NUMBERS 22-24)

C L Y N G E A J T B A C M R B U V M U B
 O U L B D L V I N Z N U N R P T B Q N E
 Q Y P L P V M C D P R O P H E T G N U H
 L Y U K A D C A R Z M J A W P O C Y D T
 R R Y O K N A T A N T K Y P Y M Z M L L
 H F F J S D G K A L A B Q N Y E K N O D
 I H K Q P Z L E A K A S B K M J H A U U
 D E T S P Z O C L O Q B Q B O D K S F W
 Y L G P R O Z J Z O H M T C E E K V L Q
 E M E M X W M W E B F J H S J S R Y Y N
 D G Y B O H F Y M H A T R D W S E K H I
 P M G B S J M J D M B U H W S E N W X S
 U B M O L Q E T W V C T T E S L C L O V
 G P Q H K I Q R Q I U A K K L B V W I U
 I M H S W L S N I O T A C I I O C W R U
 C W V S V H Q A M C T M U E A K R Z F A
 E N V R J E V S I N H E R P G G C D Y D
 U G G V E T P L T H D O T I W H H O X D
 M K S R M Y B P A I D N S Y A G R A D W
 M B T N W O Q U L U Q Q T B F D E K F T

ANGEL OF THE LORD
 BALAK
 BALAAM
 BLESSED

CURSE
 DONKEY
 JERICHO

PROPHET
 STRUCK
 TREE

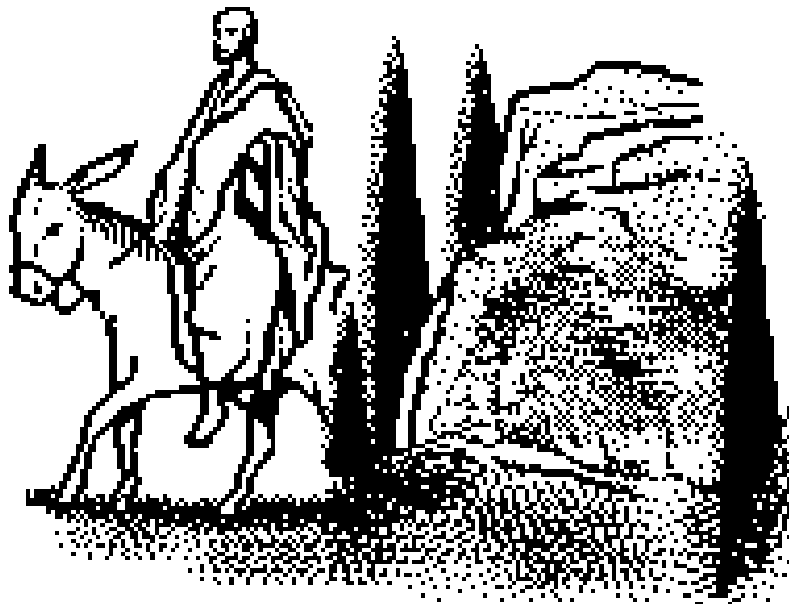

53. BALAAM

(NUMBERS 22-24)

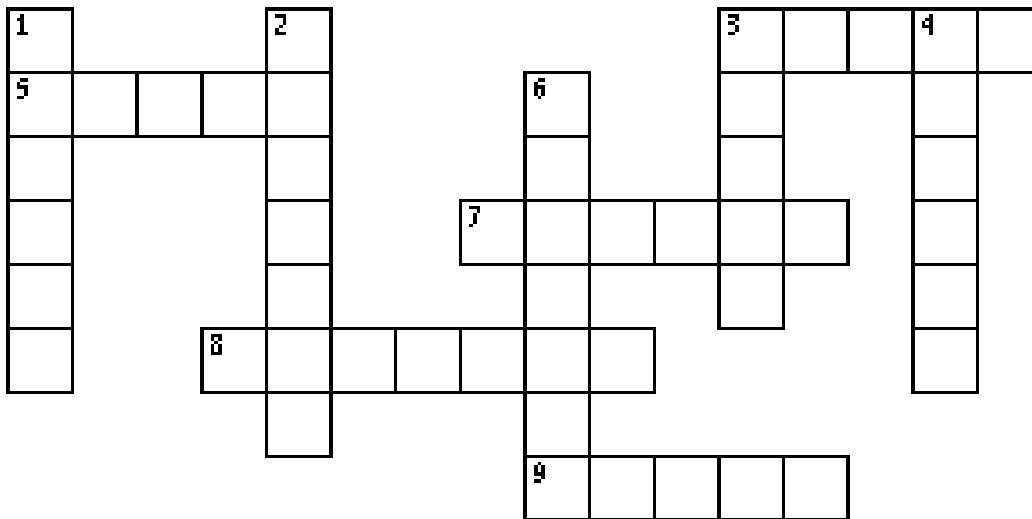

- 6 DOWN "He was rebuked for his iniquity; a dumb donkey speaking with a man's voice restrained the madness of the ____." **2 PETER 2:16**
- 8 ACROSS "The children of Israel moved ,and camped in the plains of Moab on the side of the Jordan across from ____." **NUMBERS 22:1**
- 3 DOWN Now Balak "sent messengers to Balaam the son of Beor at Pethor, which is near the River in the land of the sons of his people, to call him, saying: 'Look, a people has come from Egypt. See, they ____ the face of the earth, and are settling next to me!' " **NUMBERS 22:5**
- 3 ACROSS Balaam was asked, "Please come at once, ____ this people for me, for they are too mighty for me. Perhaps I shall be able to defeat them and drive them out of the land, for I know that he whom you bless is blessed, and he whom you curse is cursed." **NUMBERS 22:6**
- 1 DOWN "God said to ____, 'You shall not go with them; you shall not curse the people, for they are blessed.' " **NUMBERS 22:12**
- 5 ACROSS When Balaam did go, "God's anger was aroused because he went, and the ____ of the LORD took his stand in the way as an adversary against him. And he was riding on his donkey, and his two servants were with him." **NUMBERS 22:22**
- 4 DOWN "When the donkey saw the Angel of the LORD, she lay down under Balaam; so Balaam's anger was aroused, and he ____ the donkey with his staff." **NUMBERS 22:27**
- 7 ACROSS "The LORD opened the mouth of the ____, and she said to Balaam, 'What have I done to you, that you have struck me these three times?' " **NUMBERS 22:28**
- 9 ACROSS The Angel of the LORD said to Balaam, "The donkey saw Me and turned aside from Me these ____ times. If she had not turned aside from Me, surely I would also have killed you by now." **NUMBERS 22:33**
- 2 DOWN "Balak's anger was aroused against Balaam, and he struck his hands together; and Balak said to Balaam, 'I called you to curse my enemies, and look, you have bountifully ____ them these three times.'" **NUMBERS 24:10**

Bible Story 54

MOSES DIES

DEUTERONOMY 34

54. MOSES DIES (DEUTERONOMY 34)

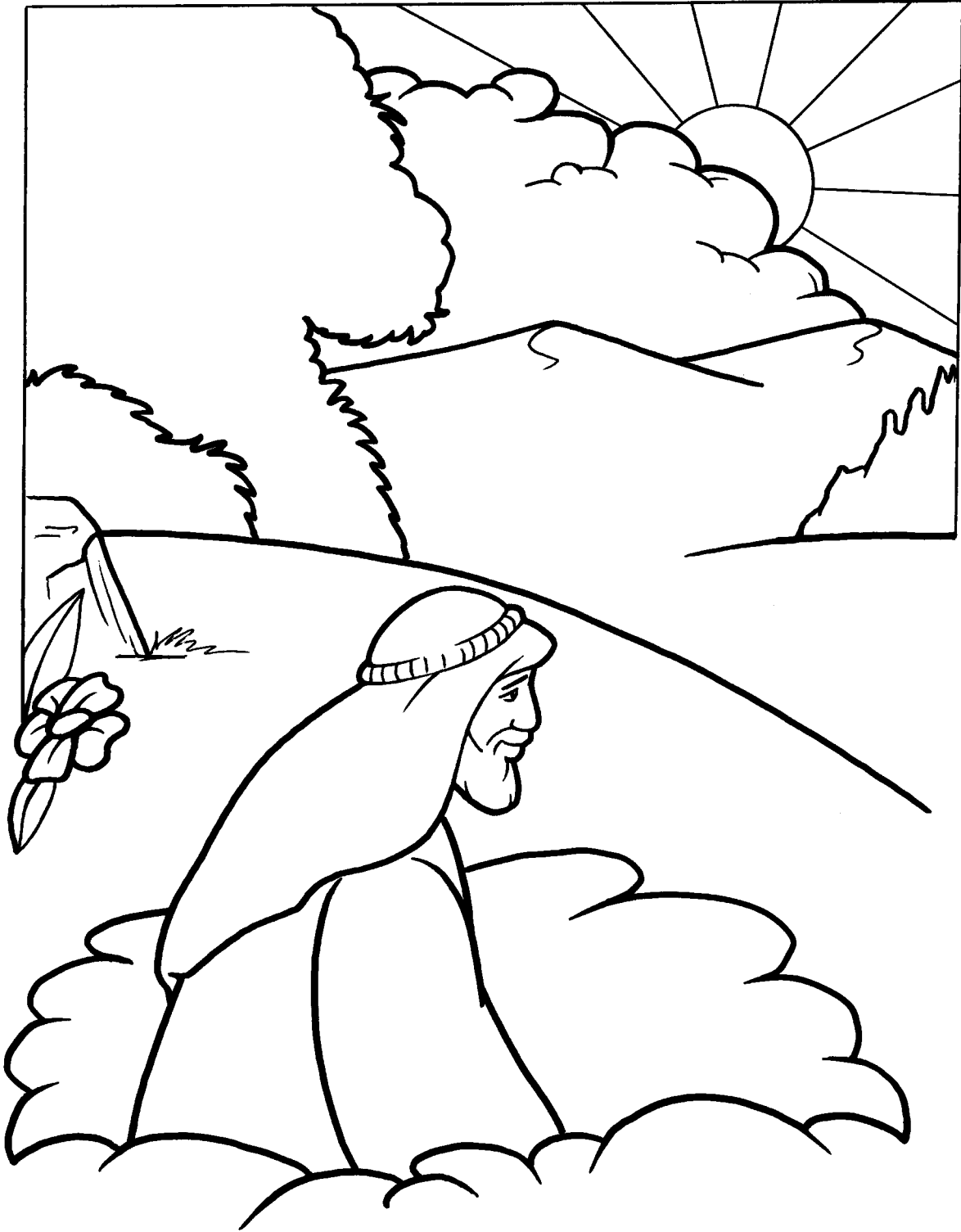

"There has not arisen in Israel a prophet like Moses, whom the LORD knew face to face."
DEUTERONOMY 34:10

54. Moses Dies

(Deuteronomy 34)

MEMORY VERSE:

"There has not arisen in Israel a prophet like Moses, whom the LORD knew face to face."
DEUTERONOMY 34:10

FILL IN THE BLANK:

1. "Moses went up from the plains of Moab to Mount _____, to the top of Pisgah, which is across from Jericho." DEUTERONOMY 34:1

"And the LORD showed him all the land of Gilead as far as Dan, all Naphtali and the land of Ephraim and Manasseh, all the land of Judah as far as the Western Sea, the South, and the plain of the Valley of Jericho, the city of palm trees, as far as Zoar." DEUTERONOMY 34:1-3

TRUE OR FALSE:

2. "Then the LORD said to him, 'This is the land of which I swore to give Abraham, Isaac, and Jacob, saying, "I will give it to your descendants." ' " DEUTERONOMY 34:4
TRUE OR FALSE
3. The LORD said, "I have caused you to see it with your eyes and you shall cross over there." DEUTERONOMY 34:4
TRUE OR FALSE
4. "So Moses the servant of the LORD died there in the land of Moab, according to the word of the LORD." DEUTERONOMY 34:5
TRUE OR FALSE

CIRCLE THE CORRECT WORDS:

5. "And He buried him in a valley in the land of Moab, opposite Beth Peor; but (NO ONE, EVERYONE) knows his grave to this day." DEUTERONOMY 34:6
6. "And the children of Israel (WEPT, LAUGHED) for Moses in the plains of Moab thirty days." DEUTERONOMY 34:8
7. "Now (JOSHUA, JEREMIAH) the son of Nun was full of the spirit of wisdom, for Moses had laid his hands on him." DEUTERONOMY 34:9
8. "There has not arisen in Israel a (SOLDIER, PROPHET) like Moses, whom the LORD knew face to face." DEUTERONOMY 34:10

MOSES DIES

(DEUTERONOMY 34)

M O S E S K D S L B
G N L Z K C I W A U
S O H C I R E J C R
N E L F B P D V W I
G U E P T U D R J E
O B E N T N U O M D
Z A U H S O J C U T
J O M G U M L M K E
P R O P H E T L O J
P F S D N A L B I K

BURIED
DIED
JERICO
JOSHUA

LAND
MOSES
MOUNT NEBO

PROPHET
SEE
WEPT



54. Moses Dies

(Deuteronomy 34)

MEMORY VERSE:

"There has not arisen in Israel a prophet like Moses, whom the LORD knew face to face."
DEUTERONOMY 34:10

CIRCLE THE CORRECT WORD:

1. "Moses went up from the plains of Moab to Mount (**NEBO, BOBO**), to the top of Pisgah, which is across from Jericho." DEUTERONOMY 34:1

"And the LORD showed him all the land of Gilead as far as Dan, all Naphtali and the land of Ephraim and Manasseh, all the land of Judah as far as the Western Sea, the South, and the plain of the Valley of Jericho, the city of palm trees, as far as Zoar." DEUTERONOMY 34:1-3

TRUE OR FALSE:

2. "Then the LORD said to him, 'This is the land of which I swore to give Abraham, Isaac, and Jacob, saying, "I will give it to your descendants." ' " DEUTERONOMY 34:4
TRUE OR FALSE

3. The LORD said, "I have caused you to see it with your eyes and you shall cross over there." DEUTERONOMY 34:4
TRUE OR FALSE

FILL IN THE BLANKS:

4. "So Moses the servant of the LORD _____ there in the land of Moab, according to the word of the LORD." DEUTERONOMY 34:5
5. "And He buried him in a valley in the land of Moab, opposite Beth Peor; but _____ knows his grave to this day." DEUTERONOMY 34:6
6. "And the children of Israel _____ for Moses in the plains of Moab thirty days." DEUTERONOMY 34:8
7. "Now _____ the son of Nun was full of the spirit of wisdom, for Moses had laid his hands on him." DEUTERONOMY 34:9
8. "There has not arisen in Israel a _____ like Moses, whom the LORD knew face to face." DEUTERONOMY 34:10

54. MOSES DIES

(DEUTERONOMY 34)

P K P L A Q A Q N C A B F G G M Y Y N M
U O K V V J S X H U Y C O W C Q K H I U
Y J S D C I T I I M O U N T N E B O S P
F Q S D D C L E U J Q D J A Z N W X V S
K S P E A E P T H K D I E D R O L O U E
T P P Z S T S A A P U W W F H Y L I U J
G M R Z L O U C F S O K S U M M W R A M
E B X O O C M L E M Q R S T M S W F D G
Y B O W E P T B F N T I P O D Y Z Y D O
G O S W Z D T Z T J D E I E R A O X W V
M J L H M N N Z Q T H A I M E D A D T S
Q H O Q F A D N H A T R N J N Y M F L P
H S K S M L R K A A U P A T C T U B A T
V S W I H J A O U B T I O K S R N E O W
V R V L Q U Z B U U R Y H G V I U H A B
G V J H S W A H T E R B C H C H D T P H
S N X T Q Y E F T N W B I G C T L L A J
N G W Y V J M V D Q P P R D H A U U D Y
B S E E P T D I D X N P E V R S F W Y K
K D E O B N W O Q N K Y J B E V L Q S P

DIED
DESCENDANTS
MOUNT NEBO
THIRTY DAYS

JOSHUA
LAND
LORD

MOSES
BURIED
PROPHET

SEE
JERICHO
WEPT



Moses Dies

(Deuteronomy 34)

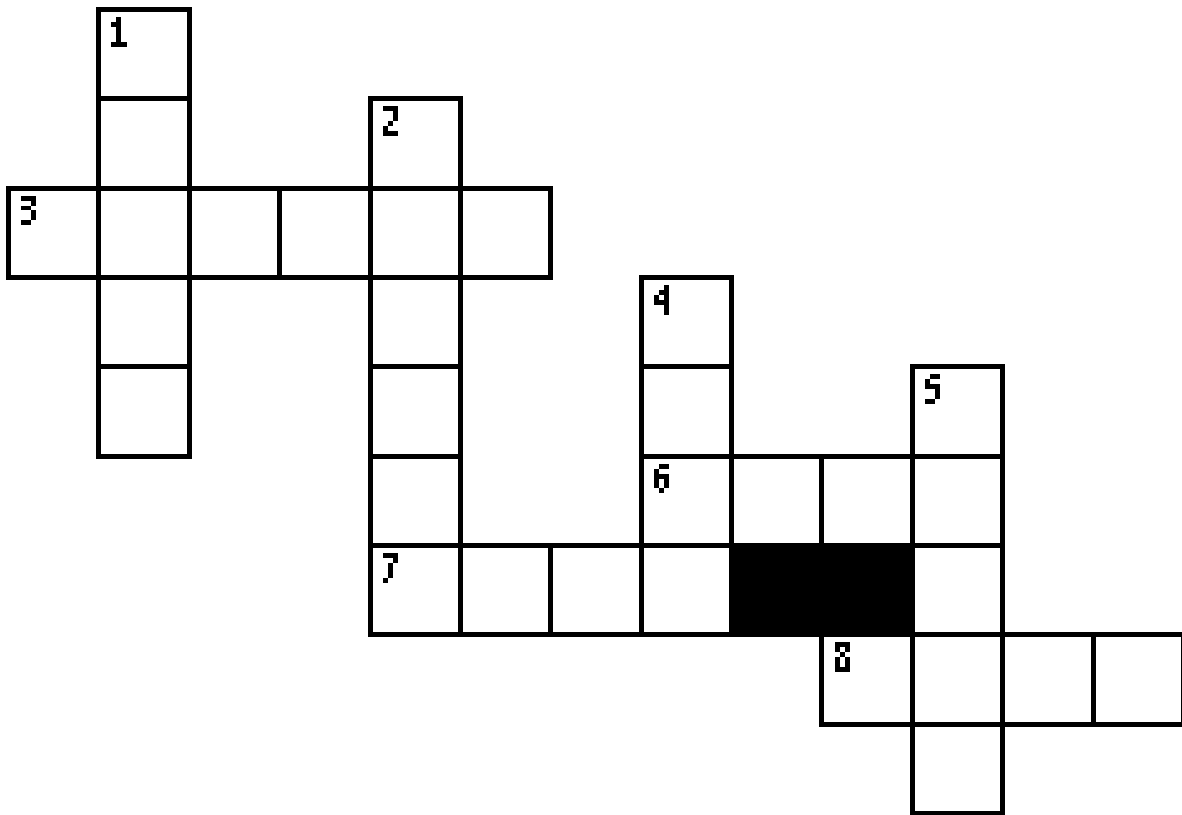

- 6 ACROSS "Moses went up from the plains of Moab to Mount _____, to the top of Pisgah, which is across from Jericho." **DEUTERONOMY 34:1**
- 4 DOWN "Then the LORD said to him, 'This is the _____ of which I swore to give Abraham, Isaac, and Jacob, saying, 'I will give it to your descendants.' ' " **DEUTERONOMY 34:4**
- 1 DOWN The LORD said, "I have caused you to see it with your eyes, but you shall not _____ over there." **DEUTERONOMY 34:4**
- 7 ACROSS "So Moses the servant of the LORD _____ there in the land of Moab, according to the word of the LORD." **DEUTERONOMY 34:5**
- 2 DOWN "And He _____ him in a valley in the land of Moab, opposite Beth Peor; but no one knows his grave to this day." **DEUTERONOMY 34:6**
- 8 ACROSS "And the children of Israel _____ for Moses in the plains of Moab thirty days." **DEUTERONOMY 34:8**
- 3 ACROSS "Now _____ the son of Nun was full of the spirit of wisdom, for Moses had laid his hands on him." **DEUTERONOMY 34:9**
- 5 DOWN "There has not arisen in Israel a prophet like _____ whom the LORD knew face to face." **DEUTERONOMY 34:10**

Bible Story 55

**JOSHUA
BECOMES ISRAEL'S
NEW LEADER**

JOSHUA 1

55. JOSHUA BECOMES ISRAEL'S NEW LEADER

(JOSHUA 1)



"According as we hearkened unto Moses in all things, so will we hearken unto thee:
only the LORD thy God be with thee, as he was with Moses."

JOSHUA 1:17

55. JOSHUA BECOMES ISRAEL'S NEW LEADER

(JOSHUA 1)

MEMORY VERSE:

"This Book of the Law shall not depart from your mouth, but you shall meditate in it day and night, that you may observe to do according to all that is written in it. For then you will make your way prosperous, and then you will have good success." JOSHUA 1:8

FILL IN THE BLANKS:

1. "After the death of Moses the servant of the Lord, it came to pass that the LORD spoke to _____ the son of Nun, Moses' assistant." **JOSHUA 1:1**
2. He said, "Be _____ and of good _____ for to this people you shall divide as an inheritance the land which I swore to their fathers to give them." **JOSHUA 1:6**

CIRCLE THE CORRECT WORDS:

3. "Have I not (**PLEADED, COMMANDED**) you? Be strong and of good courage; do not be (**AFRAID, HAPPY**), nor dismayed for the LORD your God (**IS, ISN'T**) with you wherever you go." **JOSHUA 1:9**

TRUE OR FALSE:

4. Joshua said, "Remember the word which Moses the servant of the LORD commanded you saying, 'The LORD your God is giving you rest and is giving you this land.'" **JOSHUA 1:13**
TRUE OR FALSE
5. "And they answered Joshua, saying, 'All that you command us we will do, and wherever you send us we will go.'" **JOSHUA 1:16**
TRUE OR FALSE

CIRCLE THE CORRECT WORDS:

6. "Just as we heeded Moses in (**ALL, NO**) things, so we (**WILL, WILL NOT**) heed you. Only the LORD your God be with you, as He was with Moses." **JOSHUA 1:17**
7. "Whoever rebels against your command and does not heed your words, in all that you command him, shall be put to death. Only be (**WEAK, STRONG**) and of (**NO, GOOD**) courage." **JOSHUA 1:18**

55. JOSHUA BECOMES ISRAEL'S NEW LEADER (JOSHUA 1)

C M T C P E K J Y K I L L A W
 B N O U S R T F N J P N T O A
 H R T Q E J D F M A O V B V W
 P X W D S S Y O H B U R I Q X
 H D G N O R T S L Z H H D Z P
 D E F C M T H P D F Z Q S A E
 E C E N W A U O R D R O L O N
 B U A D Q Z Q E F H I T A U J
 C E G A R U O C E F V A M A S
 P G M W T S S O U N I Q X N G
 O D F T A D S O W G V C T M D
 G T H I U J I C J X B F E G E
 C O M M A N D F N G Q H Y R P
 U A K W U Q L K S R Y P L F S
 P S N P H I S B Z Q E J I H Z

COMMAND
 COURAGE
 HEED
 JORDAN

JOSHUA
 LAW
 LORD

MOSES
 OFFICERS
 STRONG

WRITE THE LETTERS DOWN AS YOU COME TO THEM ON THE LINES BELOW

**BE STRONG
AND OF GOOD COURAGE**

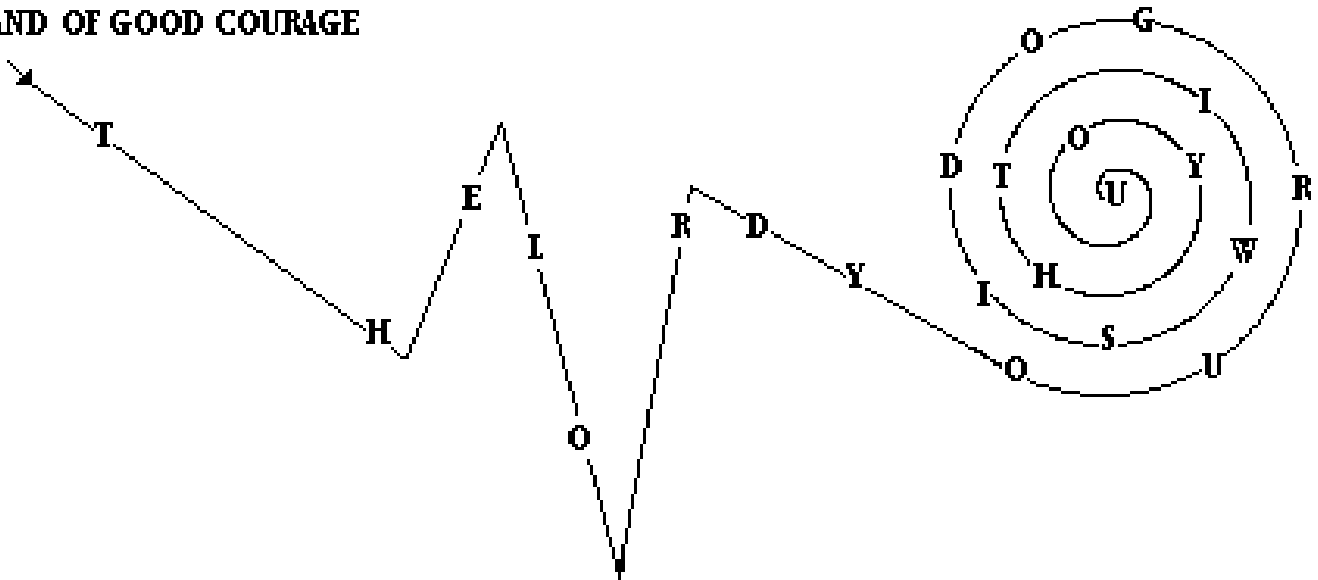

55. JOSHUA BECOMES ISRAEL'S NEW LEADER

(JOSHUA 1)

MEMORY VERSE:

"This Book of the Law shall not depart from your mouth, but you shall meditate in it day and night, that you may observe to do according to all that is written in it. For then you will make your way prosperous, and then you will have good success." JOSHUA 1:8

FILL IN THE BLANKS:

1. "After the death of Moses the servant of the Lord, it came to pass that the LORD spoke to _____ the son of Nun, Moses' assistant." **JOSHUA 1:1**
2. He said, "Be _____ and of good _____ for to this people you shall divide as an inheritance the land which I swore to their fathers to give them." **JOSHUA 1:6**
3. "Have I not commanded you? Be strong and of good courage; do not be afraid, nor dismayed for the LORD your God is _____ wherever you go." **JOSHUA 1:9**

TRUE OR FALSE:

4. "Then Joshua commanded the officers of the people, saying, 'Pass through the camp and command the people, saying, "Prepare provisions for yourselves, for within three days you will go back to Egypt." ' " **JOSHUA 1:10-11**
TRUE OR FALSE
5. Joshua said, "Remember the word which Moses the servant of the LORD commanded you saying, 'The LORD your God is giving you rest and is giving you this land.' " **JOSHUA 1:13**
TRUE OR FALSE
6. "And they answered Joshua, saying, 'All that you command us we will do, and wherever you send us we will go.' " **JOSHUA 1:16**
TRUE OR FALSE

FILL IN THE BLANKS:

7. "Just as we heeded Moses in all things, so we will heed you. Only the _____ _____ be with you, as He was with Moses." **JOSHUA 1:17**
8. "Whoever rebels against your command and does not heed your words, in all that you command him, shall be put to death. Only be _____ and of good _____ " **JOSHUA 1:18**

55. JOSHUA BECOMES ISRAEL'S NEW LEADER

(JOSHUA 1)

U C N D E K L X G T S E I L A Z F A D Y K T O Z P
 I U W J O B A T D E T A M M C Y S R D Y A M A V T
 W G T Q O Z U Y E J F W G S W S W L O D T O T F O
 V D I I C F H L P Z A L Y Z J D T W K J W E M R N
 B T W K F H S I Z Z Y Z P F U N N R Q I L M Z K I
 M A P T K N O O C K Y X Y P K J U A O J O R D A N
 C H P D B G J V C C O P B G O T D J M N A P J K J
 B S E E G A R U O C L J D K I P S U M M G N S Y J
 H T W E Y X N Q Q T V H R B T L J O L P O O M R Y
 P O Q Y D G V Z I I X G C U E J H E W T P C P G T
 D T T H N R Q U W O S E G K J C S E S O M B P I H
 E W A U M Q T A Z T V U B C K V Q P K V P U C T G
 B F U Q H I A N K A M W R O K T O T I R A L D U P
 C A U S L P Q M K N A D G U O W E C J F M P T A Y
 P M D O G R U O Y D R O L M P K W S S E V M N V Q
 O F H S D H F G Q R Z W N D Z H O C U J Q C M M D
 G H E I R Z H F J P S Y G L Y P E F E O D C G O C
 U K R L E I P H B I H P Z S Y J B H T U V V E U M
 P N J S U V J A B Q M Z J V O H K U A H S Z I V P
 M C S J W V T W R D X W P R J Q S E V G E K K Z O
 O F F I C E R S B J S B N C F O U C D F M L X A E
 N U T F J B B P K Q V M U M A A H N Q K C F A U A
 R Q A F N Q I P E R O W O L H W P Q E D Z K P W Y
 P D Z O S Y A E F I J U F B A V E L N B L S P E U
 D C S P Z E M S J L J F L P H M V K R K U M U F H

BOOK OF THE LAW
 COMMAND
 COURAGE
 HEED

JORDAN
 JOSHUA
 LORD YOUR GOD

MOSES
 OFFICERS
 STRONG

WRITE THE LETTERS DOWN AS YOU COME TO THEM ON THE LINES BELOW

**BE STRONG
 AND OF GOOD COURAGE**

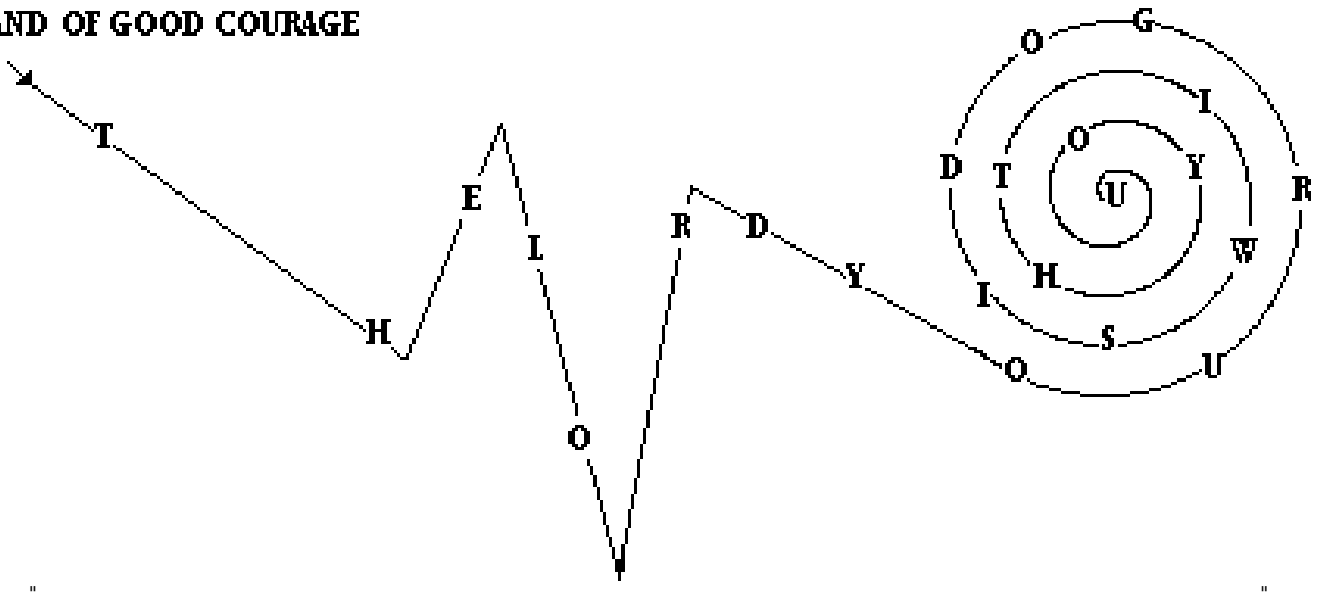

55. JOSHUA BECOMES ISRAEL'S NEW LEADER (JOSHUA 1)

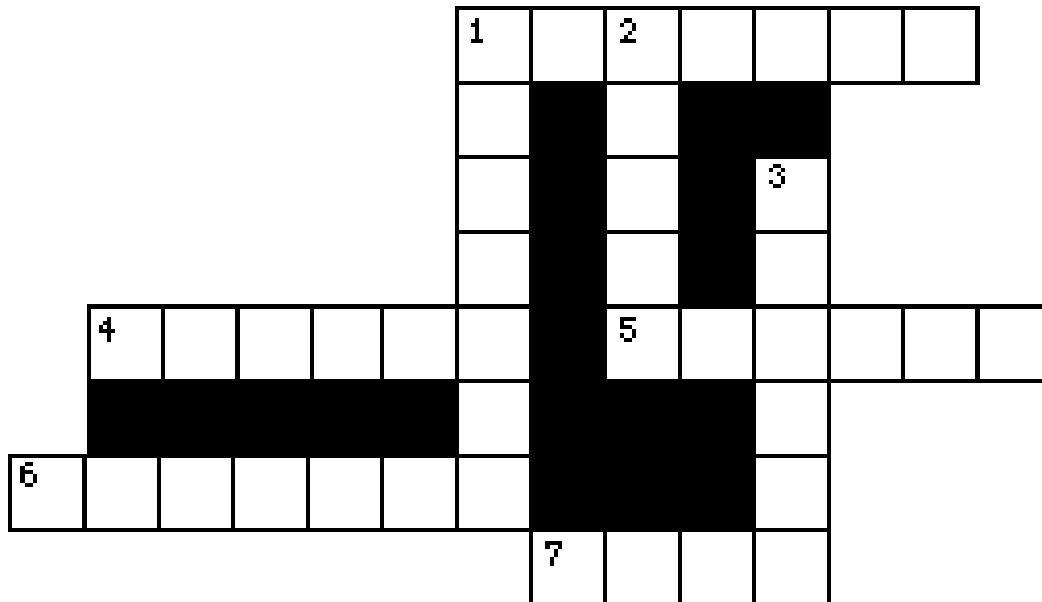

- 6 ACROSS "This Book of the Law shall not depart from your mouth, but you shall meditate in it day and night, that you may _____ to do according to all that is written in it. For then you will make your way prosperous, and then you will have good success." **JOSHUA 1:8**
- 4 ACROSS "After the death of Moses the servant of the Lord, it came to pass that the LORD spoke to _____ the son of Nun, Moses' assistant." **JOSHUA 1:1**
- 5 ACROSS He said, "Be _____ and of good courage for to this people you shall divide as an inheritance the land which I swore to their fathers to give them." **JOSHUA 1:6**
- 3 DOWN "Have I not commanded you? Be strong and of good courage; do not be _____, nor dismayed for the LORD your God is with you wherever you go." **JOSHUA 1:9**
- 7 ACROSS Joshua said, "Remember the word which Moses the servant of the _____ commanded you saying, 'The LORD your God is giving you rest and is giving you this land.'" **JOSHUA 1:13**
- 1 ACROSS "And they answered Joshua, saying, 'All that you _____ us we will do, and wherever you send us we will go.'" **JOSHUA 1:16**
- 2 DOWN "Just as we heeded Moses in all things, so we will heed you. Only the LORD your God be with you, as He was with _____." **JOSHUA 1:17**
- 1 DOWN "Whoever rebels against your command and does not heed your words, in all that you command him, shall be put to death. Only be strong and of good _____." **JOSHUA 1:18**

Bible Story 56

RAHAB AND THE SPIES

JOSHUA 2

56. RAHAB AND THE SPIES

(JOSHUA 2)



"Then she let them down by a cord through the window: for her house was upon the town wall, and she dwelt upon the wall."

JOSHUA 2:15

56. RAHAB AND THE SPIES

(JOSHUA 2)

MEMORY VERSE:

"And they said to Joshua, 'Truly the Lord has delivered all the land into our hands, for indeed all the inhabitants of the country are fainthearted because of us.' " JOSHUA 2:24

TRUE OR FALSE:

1. "Now Joshua the son of Nun sent out two men from Acacia Grove to spy secretly, saying, 'Go, view the land, especially Jericho.'" JOSHUA 2:1

TRUE OR FALSE

FILL IN THE BLANKS:

2. "The king of Jericho sent to _____, saying, 'Bring out the men who have come to you, who have entered your _____, for they have come to search out all the country.'" JOSHUA 2:3

CIRCLE THE CORRECT WORDS:

3. "Then the woman took the two men and (**FED, HID**) them; and she said, 'Yes, the men came to me, but I did not (**KNOW, CARE**) where they were from.'" JOSHUA 2:4
4. "She had brought them up to the (**roof, kitchen**) and hidden them with the stalks of (**WAX, FLAX**), which she had laid in order on the (**FLOOR, ROOF**)." JOSHUA 2:6
5. Rahab said to the two men, "Now therefore, I beg you, swear to me by the LORD, since I have shown you (**EVIL, KINDNESS**), that you also will show kindness to my (**FATHER'S, UNCLE'S**) house, and give me a true token, and spare my father, my mother, my brothers, my sisters, and all that they have, and deliver our lives from death." JOSHUA 2:12-13

TRUE OR FALSE:

6. "She let them down by a rope through the window, for her house was on the city wall; she dwelt on the wall." JOSHUA 2:15

TRUE OR FALSE

CIRCLE THE CORRECT WORDS:

7. "Then the men said to her: 'We will be blameless of this oath of yours which you have made us swear, unless, when we come into the land, you bind this line of (**SCARLET, ORANGE**) cord in the window through which you let us down and unless you bring your father, your mother, your brothers, and all your father's (**MONEY, HOUSEHOLD**) to your own home. So shall it be that whoever goes outside the doors of your house into the street, his blood shall be on his own head, and we will be guiltless. And whoever is with you in the house, his blood shall be on our head if a hand is laid on him.'" JOSHUA 2:17-19

TRUE OR FALSE:

8. "And Joshua spared Rahab the harlot, her father's household, and all that she had. So she dwells in Israel to this day, because she hid the messengers whom Joshua sent to spy out Jericho." JOSHUA 6:25

TRUE OR FALSE

"Salmon begot Boaz by Rahab, Boaz begot Obed by Ruth, Obed begot Jesse, and Jesse begot David the king." MATTHEW 1:5-6

56. RAHAB AND THE SPIES

(JOSHUA 2)

A H T A O B P N B Z X Q Q J I
 Z T J C D Z H V I R P I J Z Q
 S D M P R F Z Q A A A W B Z D
 D Y F M E H I T M U U H B K J
 C H O H C I R E J A E H A C Q
 J O O B D N V A L N S Z S B R
 F U R O U G V Q T F O O R O I
 L Q G D W X B F Y M G K R T J
 A D E R E V I L E D D L B I L
 X S P Y J G Q H L G E E R O S
 Q P P N N Y Y P I F P A E T T
 D I O M S R P J O H E R F A F
 K I N D N E S S V P Z S J N A
 I L H H Z Q E T O A C I T R Y
 K S O L K I L R Q W C K E P Y

CORD
 DELIVERED
 FLAX
 GOD
 HID

ISRAEL
 JERICHO
 JOSHUA
 KINDNESS
 OATH

RAHAB
 ROOF
 ROPE
 SPY

WRITE DOWN THE LETTERS AS YOU COME TO THEM ON THE LINES BELOW

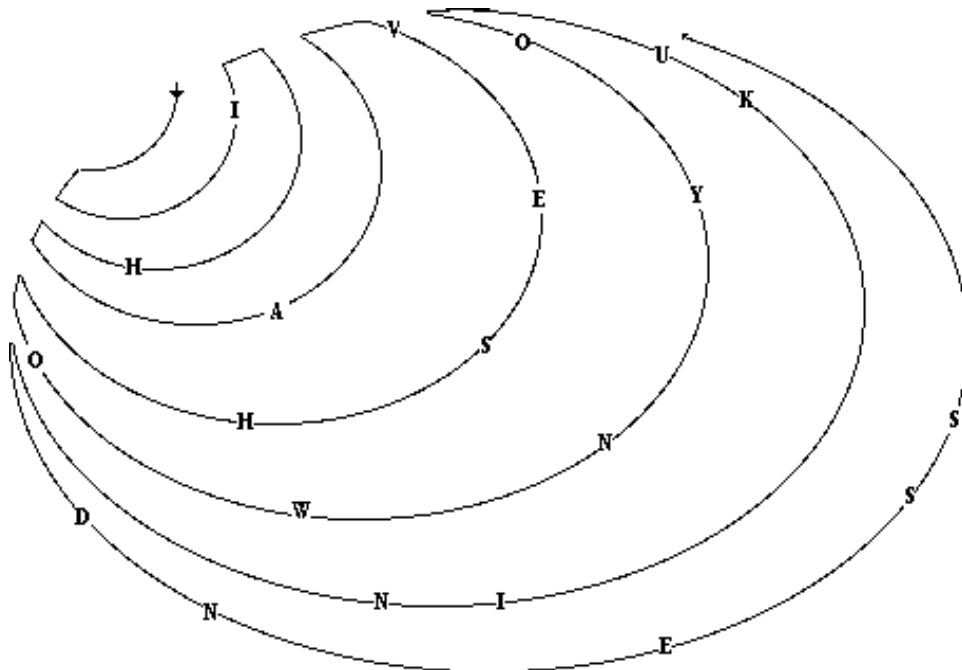

56. RAHAB AND THE SPIES

(JOSHUA 2)

MEMORY VERSE:

"And they said to Joshua, 'Truly the Lord has delivered all the land into our hands, for indeed all the inhabitants of the country are fainthearted because of us.' " JOSHUA 2:24

TRUE OR FALSE:

1. "Now Joshua the son of Nun sent out two men from Acacia Grove to spy secretly, saying, 'Go, view the land, especially Jericho.'" JOSHUA 2:1

TRUE OR FALSE

FILL IN THE BLANKS:

2. "The king of Jericho sent to _____, saying, 'Bring out the men who have come to you, who have entered your _____, for they have come to search out all the country.'" JOSHUA 2:3
3. "Then the woman took the two men and _____ them; and she said, 'Yes, the men came to me, but I did not know where they were from.'" JOSHUA 2:4
4. "She had brought them up to the _____ and hidden them with the stalks of _____, which she had laid in order on the _____." JOSHUA 2:6
5. Rahab said to the two men, "Now therefore, I beg you, swear to me by the LORD, since I have shown you _____, that you also will show _____ to my father's house, and give me a true token, and spare my father, my mother, my brothers, my sisters, and all that they have, and deliver our lives from death." JOSHUA 2:12-13

TRUE OR FALSE:

6. "She let them down by a rope through the window, for her house was on the city wall; she dwelt on the wall." JOSHUA 2:15

TRUE OR FALSE

CIRCLE THE CORRECT WORDS:

7. "Then the men said to her: 'We will be blameless of this oath of yours which you have made us swear, unless, when we come into the land, you bind this line of (**scarlet, orange**) cord in the window through which you let us down, and unless you bring your father, your mother, your brothers, and all your father's (**money, household**) to your own home. So shall it be that whoever goes outside the doors of your house into the street, his blood shall be on his own head, and we will be guiltless. And whoever is with you in the house, his blood shall be on our head if a hand is laid on him.'" JOSHUA 2:17-19

TRUE OR FALSE:

8. "And Joshua spared Rahab the harlot, her father's household, and all that she had. So she dwells in Israel to this day, because she hid the messengers whom Joshua sent to spy out Jericho." JOSHUA 2:25

TRUE OR FALSE

FILL IN THE BLANKS:

9. "Salmon begot Boaz by _____, Boaz begot Obed by Ruth, Obed begot Jesse, and Jesse begot _____." MATTHEW 1:5-6

56. RAHAB AND THE SPIES

(JOSHUA 2)

B O O T T W I J T Y V Y U U A H L I U J B I B U T
 Y J S Y C Q M K T F B M F W D J O U Q T N Z T C C
 K Q L O J M A S D O G A L Q Y Y U M T W H F P Q M
 P S K E W F F M R E C S C A R L E T C O R D Z N P
 U P P A Y I A A R J R S Y N S K I F P K X Z F R M
 Y O W V J T H I R W Z E H I D P I H T A O M V U L
 R M V C T A F J N S H V V I M G B O L M F O O R C
 F B J A B A T T W T K Y H I B K R E J L A D F K S
 K B X L N L Q A P S H K P S L G W P B U U K H B G
 T O W O A B H A N I K E O V P E G K J E V X N I E
 G H E Z F L A X K A O W A U S P D J H S A U E F Y
 E S L M S Z A U B G R H I R E S T F T U E Y E W U
 Y S V F L Z Y E C W E L C U T D K Y J O I E M L W
 G R I M P N P N D A N W R I J E O T Y H S E J J I
 M V D S U K S Q W F C W F A R O D G R S G J Q B A
 Q N D Q R O U M N M V Z Y D M E W W D R J A V B C
 H G Z S T A U N I T C O Z D G T J U C E P V E K L
 V D Z Q N B E A E O A U H S O J S G G H Z M V J P
 V P O V D H T L P M C A D W O W S H S T F U V K A
 G K W P R F T Y I J H K F T V I E P Q A B O L U I
 S S H B A V D Q Y K R U B L S H N V U F N Z A M E
 N P Q Q Z I D U B G E N E A P J D S M G K F I X Y
 B P I J E O Q Q B H M U H O T D N U J C M A L Y A
 K R L I M N C T P G Q D T A W U I X Q V Z M R A Q
 K P H C D H U H P D N L L P B O K H L U M Z U T X

- | | | | |
|----------------|---------|----------|--------------|
| DELIVERED | GOD | JOSHUA | ROOF |
| FAINTHEARTED | HID | KINDNESS | ROPE |
| FATHER'S HOUSE | ISRAEL | OATH | SCARLET CORD |
| FLAX | JERICHO | RAHAB | SPY |

WRITE DOWN THE LETTERS AS YOU COME TO THEM ON THE LINES BELOW

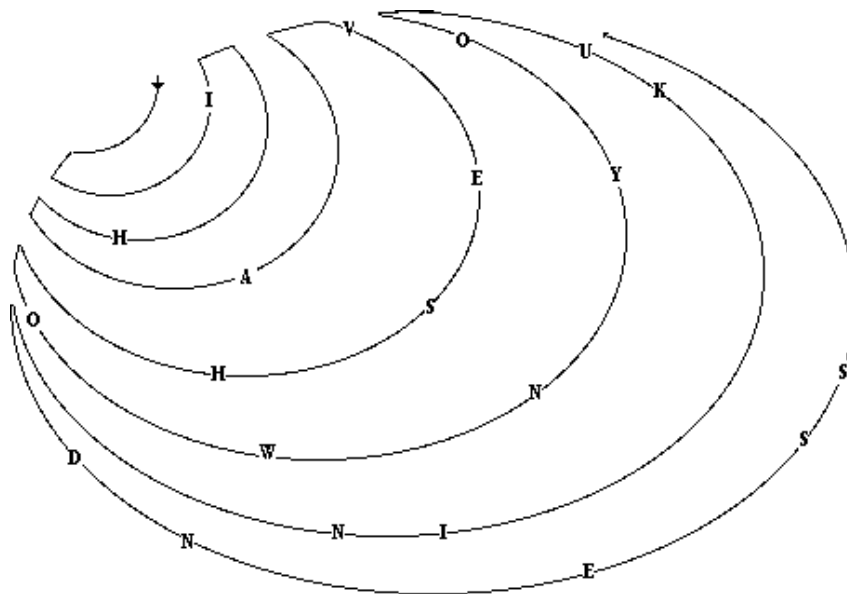

56. RAHAB AND THE SPIES

(JOSHUA 2)

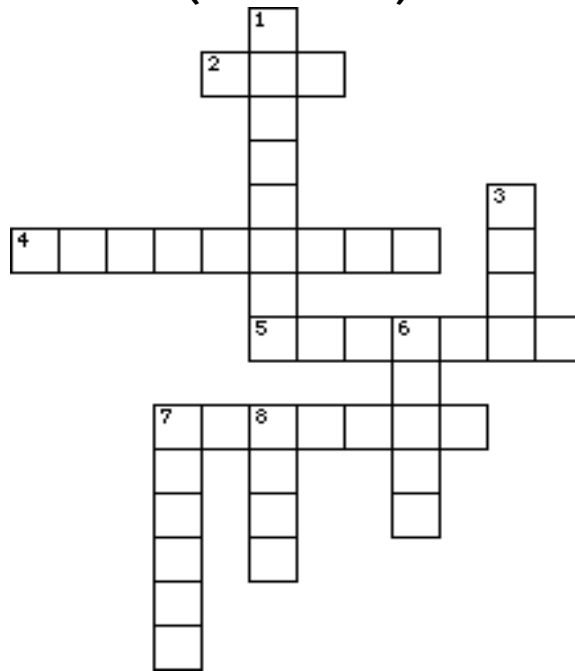

- 4 ACROSS "And they said to Joshua, 'Truly the Lord has _____ all the land into our hands, for indeed all the inhabitants of the country are fainthearted because of us.' " **JOSHUA 2:24**
- 7 ACROSS "Now Joshua the son of Nun sent out two men from Acacia Grove to spy secretly, saying, 'Go, view the land, especially _____.' " **JOSHUA 2:1**
- 6 DOWN "The king of Jericho sent to _____, saying, 'Bring out the men who have come to you, who have entered your house, for they have come to search out all the country.' " **JOSHUA 2:3**
- 2 ACROSS "Then the woman took the two men and _____ them; and she said, 'Yes, the men came to me, but I did not know where they were from.' " **JOSHUA 2:4**
- 8 DOWN "She had brought them up to the roof and hidden them with the stalks of flax, which she had laid in order on the _____." **JOSHUA 2:6**
- 1 DOWN Rahab said to the two men, "Now therefore, I beg you, swear to me by the LORD, since I have shown you _____, that you also will show kindness to my father's house, and give me a true token, and spare my father, my mother, my brothers, my sisters, and all that they have, and deliver our lives from death." **JOSHUA 2:12-13**
- 3 DOWN "She let them down by a _____ through the window, for her house was on the city wall; she dwelt on the wall." **JOSHUA 2:15**
- 5 ACROSS "Then the men said to her: 'We will be blameless of this oath of yours which you have made us swear, unless when we come into the land, you bind this line of _____ cord in the window through which you let us down " **JOSHUA 2:17-18**
- 7 DOWN "And Joshua spared Rahab the harlot, her father's household, and all that she had. So she dwells in Israel to this day, because she hid the messengers whom _____ sent to spy out Jericho." **JOSHUA 6:25**

Bible Story 57

CROSSING THE JORDAN

JOSHUA 3-4

57. CROSSING THE JORDAN RIVER

(JOSHUA 3 & 4)



"For the LORD your God dried up the waters of Jordan from before you, until ye were passed over, as the LORD your God did to the Red sea, which he dried up from before us, until we were gone over: that all the people of the earth might know the hand of the LORD, that it *is* mighty: that ye might fear the LORD your God for ever."

JOSHUA 4:23-24

57. CROSSING THE JORDAN RIVER

(JOSHUA 3 & 4)

MEMORY VERSE:

"For the LORD your God dried up the waters of the Jordan before you until you had crossed over, as the LORD your God did to the Red Sea, which He dried up before us until we had crossed over, that all the peoples of the earth may know the hand of the LORD, that it is mighty, that you may fear the LORD your God forever." JOSHUA 4:23-24

TRUE OR FALSE:

1. "The officers went through the camp; and they commanded the people, saying, 'When you see the ark of the covenant of the LORD your God, and the priests, the Levites, bearing it, then you shall set out from your place and go after it.' " **JOSHUA 3:2-3**

TRUE OR FALSE

2. "And Joshua said to the people, 'Sanctify yourselves, for tomorrow the LORD will do wonders among you.' " **JOSHUA 3:5**

TRUE OR FALSE

3. "And the LORD said to Joshua, 'This day I will begin to magnify you in the sight of all Israel, that they may know that, as I was with Moses, so I will be with you.' " **JOSHUA 3:7**

TRUE OR FALSE

CIRCLE THE CORRECT WORDS:

4. "So it was, when the people set out from their camp to cross over the (**NILE, JORDAN**), with the priests bearing the (**ARK, ART**) of the covenant before the people, and as those who bore the ark came to the Jordan, and the feet of the priests who bore the ark dipped in the edge of the water (for the Jordan overflows all its banks during the whole time of harvest), that the waters which came down from upstream stood (**STRONG, STILL**), and rose in a heap very far away at Adam, the city that is beside Zaretan. So the waters that went down into the Sea of the Arabah, the Salt Sea, failed, and were cut off; and the people (**CROSSED, STOPPED**) over opposite Jericho." **JOSHUA 3:14-16**

FILL IN THE BLANKS:

5. "Then the _____ who bore the ark of the covenant of the LORD stood firm on _____ ground in the midst of the Jordan; and all Israel crossed over on dry ground, until all the people had _____ completely over the Jordan." **JOSHUA 3:17**

CIRCLE THE CORRECT WORDS:

6. "Take for yourselves _____ men from the people, one man from each tribe." **JOSHUA 4:2**

TWELVE TEN FIFTEEN

7. "And those twelve _____ which they took from the Jordan; Joshua set up in Gilgal." **JOSHUA 4:20**

FISH STONES SHELLS

8. "That all the people of the earth may know the hand of the LORD, that it is _____, that you may fear the LORD your God forever." **JOSHUA 4:24**

WEAK SCARED MIGHTY

57. CROSSING THE JORDAN RIVER

(JOSHUA 3-4)

W S R E D N O W W H W B N F R
Z R Z A J F X H D G U N G I S
K B Z D R O L M R E F D G P C
K J O S H U A M Y U I R Z G M
Q K S E T I V E L W X C J K L
J E K N Q A S S A D J G P B B
I F C R R Y V V N W O R N U X
S J T P I Y M O D Y R G U A A
R D E D N A M M O C D D O N N
A K R A S E N O T S A E P U W
E T I I L O A J L P N S L M J
L E O Q S F Z J Z Z G S L D U
O F F I C E R S Y W Y O M L K
B J T D T V S E P B P R S S O
B Y T H G I M A J M Y C Z V I

ARK
COMMANDED
CROSSED
DRY LAND
ISRAEL

JORDAN
JOSHUA
LEVITES
LORD
MIGHTY

OFFICERS
SIGN
STONES
WONDERS

57. CROSSING THE JORDAN RIVER

(JOSHUA 3 & 4)

MEMORY VERSE:

"For the LORD your God dried up the waters of the Jordan before you until you had crossed over, as the LORD your God did to the Red Sea, which He dried up before us until we had crossed over, that all the peoples of the earth may know the hand of the LORD, that it is mighty, that you may fear the LORD your God forever." JOSHUA 4:23-24

TRUE OR FALSE:

1. "The officers went through the camp; and they commanded the people, saying, 'When you see the ark of the covenant of the LORD your God, and the priests, the Levites, bearing it, then you shall set out from your place and go after it.' " **JOSHUA 3:2-3**

TRUE OR FALSE

2. "And Joshua said to the people, 'Sanctify yourselves, for tomorrow the LORD will do wonders among you.' " **JOSHUA 3:5**

TRUE OR FALSE

FILL IN THE BLANKS:

3. "And the LORD said to Joshua, 'This day I will begin to magnify you in the sight of all Israel, that they may know that, as I was with Moses, so _____ ' " **JOSHUA 3:7**

4. "So it was, when the people set out from their camp to cross over the _____, with the priests bearing the _____ of the covenant before the people, and as those who bore the ark came to the Jordan, and the feet of the priests who bore the ark dipped in the edge of the water (for the Jordan overflows all its banks during the whole time of harvest), that the waters which came down from upstream stood _____, and rose in a heap very far away at Adam, the city that is beside Zaretan. So the waters that went down into the Sea of the Arabah, the Salt Sea, failed, and were cut off; and the people _____ over opposite Jericho." **JOSHUA 3:14-16**

5. "Then the _____ who bore the ark of the covenant of the LORD stood firm on _____ ground in the midst of the Jordan; and all Israel crossed over on dry ground, until all the people had crossed completely over the Jordan." **JOSHUA 3:17**

CIRCLE THE CORRECT WORDS:

6. "Take for yourselves _____ men from the people, one man from each tribe." **JOSHUA 4:2**
TWELVE TEN FIFTEEN

7. "And those twelve _____ which they took from the Jordan, Joshua set up in Gilgal." **JOSHUA 4:20**
FISH STONES SHELLS

8. "That all the people of the earth may know the hand of the LORD, that it is _____, that you may fear the LORD your God forever." **JOSHUA 4:24**
WEAK SCARED MIGHTY

57. CROSSING THE JORDAN RIVER

(JOSHUA 3-4)

A F Q I F S D D M M O J E C E R Y L M F O D R I G
M D E S S O R C S L J H B H A F V P N G I S P P R
P H J O A V W R Z B F Q M U V S Q M Z R U C J G H
T A B T Y O Y C F M A O S E L D A C J K V M P C U
Y W B A Y J P G P A H A U C E E O N S K Z P Q J V
L X I S R A E L G C A W H N V J D G C Y A O X N Y
I O R N O J Z R K W H V P Q I O V C G T U E Q H Y
O P F D O G R U O Y D R O L T U S V M N I A F E R
V E B F F E W G B J Z M E L E G M J X R I F G D T
Q S K R I A B N U U Y F V K S F C O P G E V Y B E
Z G E P V C M G K K N S A D D K Z S C I F Y I Y U
W D F I P W E Z C O J W R D Q D L H D K P U A L S
O E J Q S L W R U I T U L O E B U U T U T H M R S
N P T D V Z U J S T P D W K N K T A X A O A M L F
D Z T N A N E V O C E H T F O K R A X D N E A J J
E C E J A X F Y T H G I M Q R K M Z G E I C O M S
R C J D M P I P M E L S J L Y A O K E D J N K V G
S Q R Q A J X N D J J J U L Y T E F I N J A C W R
U O Z R Z H G U L K C H O W D W M D K A Y I Y Z A
J I Z I S G Y O S K V Q E K J L N K L M T Z U F S
T W E L V E S T O N E S P I I A X S P M H S D I F
A W P L H E P F V P T O T J L A N M P O G N Y Z N
N Z C S M U Y L R Z W E C Y P P O O U C F C G T T
M K Y F I N G A M Y H W R S T P B A Z V Y Z T M Q
G K T T M W B L C Y P D S U V A U T V X Q X I G C

ISRAEL	JORDAN	LORD YOUR GOD	SANCTIFY
COMMANDED	JOSHUA	MAGNIFY	SIGN
CROSSED	LEVITES	MIGHTY	TWELVE STONES
DRY LAND	LIVING GOD	OFFICERS	WONDERS
ARK OF THE COVENANT			

57. CROSSING THE JORDAN RIVER

(JOSHUA 3 & 4)

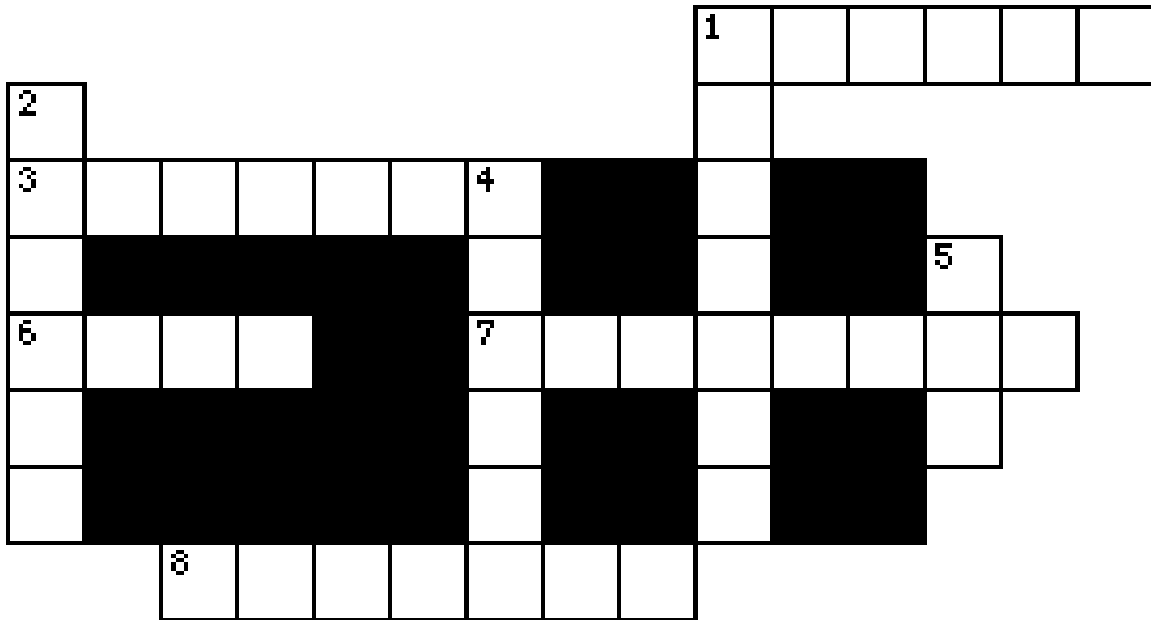

- 6 ACROSS "For the _____ your God dried up the waters of the Jordan before you until you had crossed over." **JOSHUA 4:23**
- 7 ACROSS "The _____ went through the camp; and they commanded the people, saying, 'When you see the ark of the covenant of the LORD your God, and the priests, the Levites, bearing it, then you shall set out from your place and go after it.'" **JOSHUA 3:2-3**
- 3 ACROSS "And Joshua said to the people, 'Sanctify yourselves, for tomorrow the LORD will do _____ among you.'" **JOSHUA 3:5**
- 1 DOWN "And the LORD said to Joshua, 'This day I will begin to _____ you in the sight of all Israel, that they may know that, as I was with Moses, so I will be with you.'" **JOSHUA 3:7**
- 8 ACROSS "So the waters that went down into the Sea of the Arabah, the Salt Sea, failed, and were cut off; and the people _____ over opposite Jericho." **JOSHUA 3:16**
- 5 DOWN "Then the priests who bore the ark of the covenant of the LORD stood firm on _____ ground in the midst of the Jordan; and all Israel crossed over on dry ground, until all the people had crossed completely over the Jordan." **JOSHUA 3:17**
- 2 DOWN "Take for yourselves _____ men from the people, one man from each tribe." **JOSHUA 4:2**
- 4 DOWN "And those twelve _____ which they took from the Jordan, Joshua set up in Gilgal." **JOSHUA 4:20**
- 1 ACROSS "That all the people of the earth may know the hand of the LORD, that it is _____, that you may fear the LORD your God forever." **JOSHUA 4:24**

Bible Story 58

THE BATTLE OF JERICHO

JOSHUA 6:1-26

58. BATTLE OF JERICHO

(JOSHUA 6:1-26)



"And it came to pass at the seventh time, when the priests blew with the trumpets, Joshua said unto the people, Shout; for the LORD hath given you the city."

JOSHUA 6:16

58. BATTLE OF JERICHO

(JOSHUA 6:1-26)

MEMORY VERSE:

"And the LORD, said to Joshua: 'See! I have given Jericho into your hand, its king, and the mighty men of valor.' " JOSHUA 6:2

CIRCLE THE CORRECT WORDS:

1. *"And the LORD, said to ____ 'See! I have given Jericho into your hand, its king, and the mighty men of valor.' "* JOSHUA 6:2
JOSHUA MOSES
2. "You shall march around the city, all you men of war; you shall go around the city once. This you shall do ____ days." JOSHUA 6:3
SIX SIXTY
3. "But the seventh day you shall march around the city seven times, and the priest shall blow the ____." JOSHUA 6:4
FLUTES TRUMPETS

TRUE OF FALSE:

4. Joshua told the priest, "Take up the ark of the covenant and let seven priests bear seven trumpets of rams' horns before the ark of the LORD." JOSHUA 6:6
TRUE OR FALSE
5. "Now Joshua had commanded the people, saying, 'You shall not shout or make any noise with your voice, nor shall a word proceed out of your mouth, until the day I say to you, "Whisper"! Then you shall whisper.' " JOSHUA 6:10
TRUE OR FALSE

CIRCLE THE CORRECT WORDS:

6. "So the people (**WHISPERED, SHOUTED**) when the priests blew their trumpets. And it happened when the people heard the sound of the trumpet, and the people (**WHISPERED, SHOUTED**) with a great (**WHISPER, SHOUT**), that the wall fell down flat. Then the people went up into the city, every man straight before him, and they took the city." JOSHUA 6:20
7. "And Joshua spared (**BABAH, RAHAB**) the harlot, her father's household, and all that she had. So she dwells in Israel to this day, because she hid the messengers whom Joshua sent to spy out Jericho." JOSHUA 6:25

TRUE OF FALSE:

8. "So the LORD was with Joshua, and his fame spread throughout all the country." JOSHUA 6:27
TRUE OR FALSE

58. THE BATTLE OF JERICHO

(JOSHUA 6:1-26)

G A U H S O J A E U W D R L C
 D W K K R R Y Z A B U L L A F
 E Z E L L A W S A L U R G L U
 P S H O U T Y H N R E R N M M
 Z K S Y A D X I S E K A N S D
 C K P C P I O M W W V C R E L
 R Q J T I L F L L D F I G S D
 A J T I Q S V S Z W I G G Z I
 H S E M I T N E V E S O Z F S
 A B E O D R O L P Y M H J P V
 B B J T D T L V P P G C P G R
 C R Z A J F S O J Z Y I N K C
 T R U M P E T S H W P R U B M
 Q B Z N Q A V J G B Y E O U L
 I H C R A M M J E M B J F T B

ARK
 BURNED
 FALL
 GIVEN
 ISRAEL

JERICHO
 JOSHUA
 LORD
 MARCH
 RAHAB

SEVEN TIMES
 SHOUT
 SIX DAYS
 TRUMPETS
 WALL

SOUND THE TRUMPET!

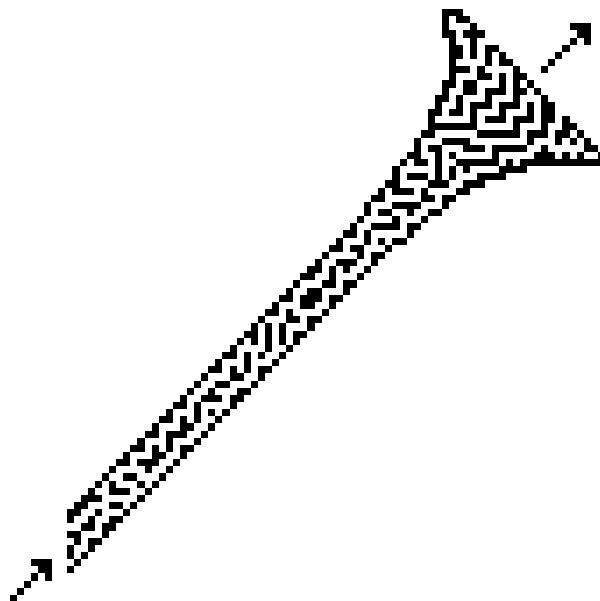

58. BATTLE OF JERICHO

(JOSHUA 6:1-26)

MEMORY VERSE:

"And the LORD, said to Joshua: 'See! I have given Jericho into your hand, its king, and the mighty men of valor.' " JOSHUA 6:2

FILL IN THE BLANKS:

1. "And the LORD, said to _____ : 'See! I have given Jericho into your hand, its king, and the mighty men of valor.' " JOSHUA 6:2
2. "You shall march around the city, all you men of war; you shall go around the city once. This you shall do _____ days." JOSHUA 6:3
3. "But the seventh day you shall march around the city seven times, and the priest shall blow the _____." JOSHUA 6:4

TRUE OF FALSE:

4. Joshua told the priest, "Take up the ark of the covenant and let seven priests bear seven trumpets of rams' horns before the ark of the LORD." JOSHUA 6:6
TRUE OR FALSE
5. "Now Joshua had commanded the people, saying, 'You shall not shout or make any noise with your voice, nor shall a word proceed out of your mouth, until the day I say to you, "Whisper"! Then you shall whisper.' " JOSHUA 6:10
TRUE OR FALSE

FILL IN THE BLANKS:

6. "So the people _____ when the priests blew their trumpets. And it happened when the people heard the sound of the trumpet, and the people shouted with a great shout, that the wall fell down flat. Then the people went up into the city, every man straight before him, and they _____." JOSHUA 6:20
7. "And Joshua spared _____ the harlot, her father's household, and all that she had. So she dwells in Israel to this day, because she hid the messengers whom Joshua sent to spy out Jericho." JOSHUA 6:25

TRUE OF FALSE:

8. "So the LORD was with Joshua, and his fame spread throughout all the country." JOSHUA 6:27
TRUE OR FALSE

58. THE BATTLE OF JERICHO

(JOSHUA 6:1-26)

P T Q Y B N T I Z Z F A M O L H W P Q N J V P D U
D D R O L G D O C Z A W W F B A V E L R F A L L A
E W T H Y X E V C K Y L U L X J M V K Y O Q M T V
B F A U N G N Q Q C Y Z F L A O O A D Y U D C X X
C A U Q M R R Z I T O X I M C H H S D D G V C X O
P M U S H Q U U W I F P X S W Z F C H S H O U T U
O M H S L I B A Z O V J G Z J Y S R I U F S V G V
G F A S T E P M U R T H Y F U N W L O R A M Z E Z
U H E R D P A N K T X G P P K J U W K L E C K I A
P K R I C H Q M K A S E Y G O T D J Q J L J F K U
M N J L R H F G Q N V U B K I P B A H A R A K X E
N C S S E Z H F J R M W D B T L S U P I K Z W P F
R U T J U I P H B P A D R U E J J O L P D L S P P
X Q A F W V J A B I Z W C K J C H E W T B U M U T
D D T N A N E V O C E H T F O K R A K S K T O Z O
C C Z F J V T W R Q S Y G C K V Q P I Y K M A V N
U N S O N B B X B D H P R U K T O T J A A O T F I
G W D P S Q I P K J M Z G M P W E C S D T E M R J
D T J E Z Y A E E Q X W N D Z H W S U L W M Z K J
T I Q O K E M S F R S B G L Y P E C E I L X J K Y
S E V E N T I M E S V G Z S Y J B H A S A N S Y T
A W I O B L X G J I O I J V O H K U V V P O M R H
S P K C Z N T D T L J V P R J Q S E D R P B X G G
T P T F F V Y E E S J E N C F O U C Q F A U P I F
O W D K H Q L P J T E N U M A A H N E E X L C K Y

ARK OF THE COVENANT
BURNED
FALL
GIVEN
JERICHO

JOSHUA
LORD
MARCH
RAHAB
SEVEN TIMES

SHOUT
SIX DAYS
TRUMPETS
WALL

SOUND THE TRUMPET!

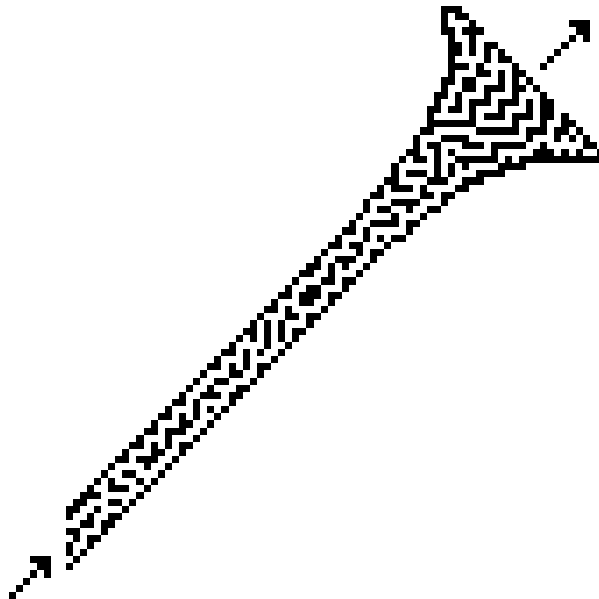

58. BATTLE OF JERICHO

(JOSHUA 6:1-26)

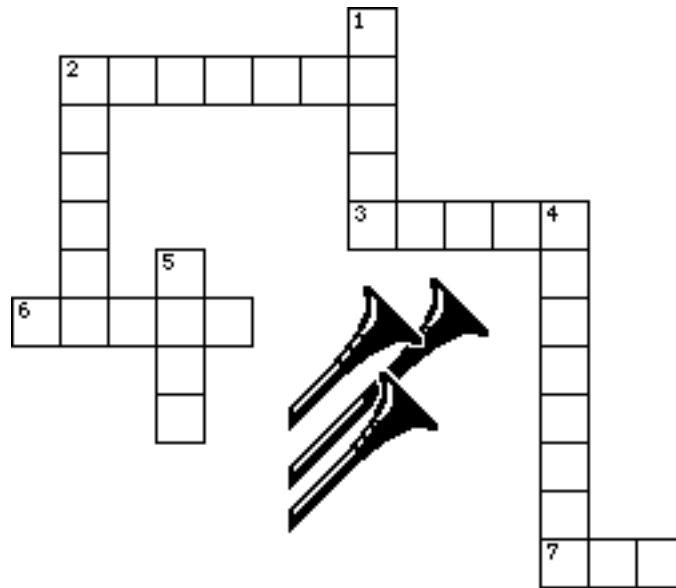

- 2 ACROSS "And the LORD, said to Joshua: 'See! I have given _____ into your hand, its king, and the mighty men of valor.' " **JOSHUA 6:2**
- 7 ACROSS "You shall march around the city, all you men of war; you shall go around the city once. This you shall do _____ days." **JOSHUA 6:3**
- 4 DOWN "But the seventh day you shall march around the city seven times, and the priest shall blow the _____." **JOSHUA 6:4**
- 1 DOWN Joshua told the priest, "Take up the ark of the covenant and let seven priests bear seven trumpets of rams' _____ before the ark of the LORD." **JOSHUA 6:6**
- 3 ACROSS "Now Joshua had commanded the people, saying, 'You shall not shout or make any noise with your voice, nor shall a word proceed out of your mouth, until the day I say to you, " _____"! Then you shall shout.' " **JOSHUA 6:10**
- 5 DOWN "So the people shouted when the priests blew their trumpets. And it happened when the people heard the sound of the trumpet, and the people shouted with a great shout, that the _____ fell down flat. Then the people went up into the city, every man straight before him, and they took the city." **JOSHUA 6:20**
- 6 ACROSS "And Joshua spared _____ the harlot, her father's household, and all that she had. So he dwells in Israel to this day, because she hid the messengers whom Joshua sent to spy out Jericho." **JOSHUA 6:25**
- 2 DOWN "So the LORD was with _____, and his fame spread throughout all the country." **JOSHUA 6:27**

Bible Story 59

**THE GIBEONITES
TRICK JOSHUA**

JOSHUA 9

59. THE GIBEONITES TRICK JOSHUA (JOSHUA 9)



"And when the inhabitants of Gibeon heard what Joshua had done unto Jericho and to Ai, They did work wilily, and went and made as if they had been ambassadors, and took old sacks upon their donkeys, and wine bottles, old, and rent, and bound up; and old shoes and clouted upon their feet, and old garments upon them; and all the bread of their provision was dry *and* mouldy."

JOSHUA 9:3-5

59. THE GIBEONITES TRICK JOSHUA

(JOSHUA 9)

MEMORY VERSE:

"There are many plans in a man's heart, nevertheless the LORD'S counsel - that will stand." PROVERBS 19:21

UNDERLINE ALL THE TRUE STATEMENTS:

1. "When the inhabitants of Gibeon heard what Joshua had done to Jericho and Ai,..." **JOSHUA 9:3-5**
 - * they worked craftily
 - * they pretended to be ambassadors
 - * they attacked the camp
 - * they took old sacks on their donkeys
 - * they took old wineskins torn and mended
 - * they had old and patched sandals on their feet
 - * they had old garments on themselves
 - * and all the bread of their provision was very fresh

CIRCLE THE CORRECT WORD:

2. "And they went to Joshua, to the camp at Gilgal, and said to him and to the men of Israel, 'We have come from a ____ country; now therefore, make a covenant with us.'" **JOSHUA 9:6**

NEAR FAR

TRUE OR FALSE:

3. The men of Israel took some of their provisions and they asked counsel of the LORD. **JOSHUA 9:14**

TRUE OR FALSE
4. "The children of Israel did not attack them, because the rulers of the congregation had sworn to them by the LORD God of Israel. And all the congregation murmured against the rulers." **JOSHUA 9:18**

TRUE OR FALSE

CIRCLE THE CORRECT WORDS:

5. "Then all the rulers said to all the congregation, 'We have sworn to them by the LORD God of Israel; now therefore, we may not (**TOUCH, FEED**) them. This we will do to them: we will let them live, lest (**JOY, WRATH**) be upon us because of the oath which we swore to them.'" **JOSHUA 9:19-20**

59. THE GIBEONITES TRICK JOSHUA

(JOSHUA 9)

W I F T J F H I P W T C K D Y
I T A P H S S B E J C N L L D
N E H L Q R Q K V U S Q W O E
E J A J A W S T N E M R A G S
S K D E D N E T E R P L K U R
K K L C O U O S A O C K I E U
I P H V A D J O S H U A J A C
N Z Z T W S E N O E B I G V D
S S R E I R R A C R E T A W J
W Y Y W V T N A N E V O C D I
J Y Y L I T F A R C H D N Q P
U B R E A D W U R E U D R E T
W O O D C U T T E R S O O N V
K O N H M J E H L P E K T R R
O J J P S L A D N A S Q S Y F

BREAD

GARMENTS

OLD

WATER CARRIERS

COVENANT

GIBEON

PRETENDED

WINESKINS

CRAFTILY

ISRAEL

SANDALS

WOODCUTTERS

CURSED

JOSHUA

TORN

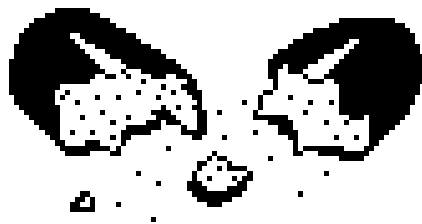

59. THE GIBEONITES TRICK JOSHUA

(JOSHUA 9)

MEMORY VERSE:

"There are many plans in a man's heart, nevertheless the LORD'S counsel - that will stand." PROVERBS 19:21

UNDERLINE ALL THE TRUE STATEMENTS:

1. "When the inhabitants of Gibeon heard what Joshua had done to Jericho and Ai,..." **JOSHUA 9:3-5**
 - * they worked craftily
 - * they pretended to be ambassadors
 - * they attacked the camp
 - * they took old sacks on their donkeys
 - * they took old wineskins torn and mended
 - * they had old and patched sandals on their feet
 - * they had old garments on themselves
 - * and all the bread of their provision was very fresh

FILL IN THE BLANK:

2. "And they went to Joshua, to the camp at Gilgal, and said to him and to the men of Israel, 'We have come from a _____ country; now therefore, make a covenant with us.'" **JOSHUA 9:6**

TRUE OR FALSE:

3. The men of Israel took some of their provisions and they asked counsel of the LORD. **JOSHUA 9:14**

TRUE OR FALSE

FILL IN THE BLANKS:

4. "The children of Israel did not attack them, because the _____ of the congregation had sworn to them by the LORD God of Israel. And all the congregation _____ against the rulers." **JOSHUA 9:18**
5. "Then all the rulers said to all the congregation, 'We have sworn to them by the LORD God of Israel; now therefore, we may not _____ them. This we will do to them: we will let them live, lest _____ be upon us because of the oath which we swore to them.'" **JOSHUA 9:19-20**
6. The Gibeonites said to Joshua, "And now, here we are, in your hands; do with us as it seems (**GOOD, BAD**) and (**RIGHT, WRONG**) to do to us." **JOSHUA 9:25**

59. THE GIBEONITES TRICK JOSHUA

(JOSHUA 9)

B F Q V E E Q M J P F J N W J D Y A L S P Z M P P
 Y S L A D N A S H Y P U J U U D Y T U M P A P J G
 N H T Q P F D A G B G K T D O C D W T O U U O P C
 M N A Z Z J J Z E D K O P S G S R L M A Z E E Q J
 H G Q U C T Q S U R B I L J I O T A O T V F A X N
 L X O L D E R H W C U T J H B K J N F M F P Y Q H
 D C F A C J I M D G K E C Q E Q I A E T R T U F E
 R G O S N I K S E N I W V O O K P P E M I O H G D
 E R H V Q Z L M W R C J T E N L T T M Z R L A A B
 U Q P N E Z S S Y G U K W W E W V O M J K A Y M Y
 W I J M I N T V P N M K H E P K R R N S K N G M K
 I P T G W K A O Z G D P W B T I F N O M Y I E A K
 S H B F Z C F N W Z L Z P A C J E P B X R J C O J
 R Z I H K T A J T J S Y J K T S J A U P G J N K M
 A I S R E T T U C D O O W S S E O X L C I Y A C V
 E V A A K I Y J B P V Y H U C U R V P D K T I Y W
 L V M W Q O Y E M N R O Q H H E U C M T B H Z U Z
 J B X X J T O A W U C J O P U A G Q A X U R S D F
 N Q T P B A F W U O M F A E E V F D C R A G E Y I
 S Y Y E B N V L F F L A W V C D E D C X R F N A Z
 P R E T E N D E D L B H V A N S K V V G V I C G D
 Z E L S R R L Z I L X A M R R Q D S Z E P Y E T T
 K L I G B P S M H M A H F U Q E B M Y I O Q Z R M
 B N A U H S O J G S C Z C L L N P C F T M D X I S
 Z V O D K I V P Y Z W Y S W K R L Z L L V C R I G

BREAD

GARMENTS

OLD

WATER CARRIERS

COVENANT

GIBEON

PRETENDED

WINESKINS

CRAFTILY

ISRAEL

SANDALS

WOODCUTTERS

CURSED

JOSHUA

TORN



59. THE GIBEONITES TRICK JOSHUA

(JOSHUA 9)

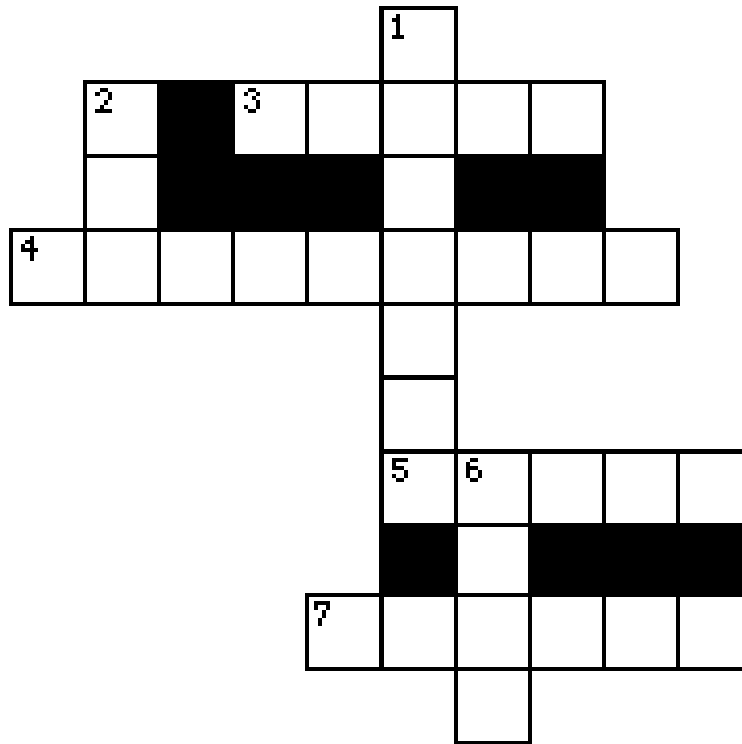

- 5 ACROSS "There are many plans in a man's heart, nevertheless the _____ counsel - that will stand." **PROVERBS 19:21**
- 4 ACROSS "When the inhabitants of Gibeon heard what Joshua had done to Jericho and Ai, they worked craftily and went and _____ to be ambassadors." **JOSHUA 9:3-5**
- 2 DOWN "And they went to Joshua, to the camp at Gilgal, and said to him and to the men of Israel, 'We have come from a _____ country; now therefore, make a covenant with us.'" **JOSHUA 9:6**
- 1 DOWN "The men of Israel took some of their provisions, but they did not ask _____ of the LORD." **JOSHUA 9:14**
- 7 ACROSS "The children of Israel did not _____ them, because the rulers of the congregation had sworn to them by the LORD God of Israel. And all the congregation murmured against the rulers." **JOSHUA 9:18**
- 3 ACROSS "Then all the rulers said to all the congregation, 'We have _____ to them by the LORD God of Israel; now therefore, we may not touch them.'" **JOSHUA 9:19**
- 6 DOWN "This we will do to them: we will let them live, lest wrath be upon us because of the _____ which we swore to them." **JOSHUA 9:20**

Bible Story 60

JOSHUA DIES

JUDGES 2:7-10

60. JOSHUA DIES (JUDGES 2:7-10)



"And Joshua the son of Nun, the servant of the LORD, died, *being* an hundred and ten years old. And they buried him in the border of his inheritance in Timnathheres, in the mount of Ephraim, on the north side of the hill Gaash."

JUDGES 2:8-9

60. JOSHUA DIES

(JUDGES 2:7-10)

MEMORY VERSE:

"You have seen all that the LORD your God has done to all these nations because of you, for the LORD your God is He who has fought for you." JOSHUA 23:3

TRUE OR FALSE:

1. "The people served the LORD all the days of Joshua." **JUDGES 2:7**
TRUE OR FALSE
2. And the people served the LORD "all the days of the elders who outlived Joshua." **JUDGES 2:7**
TRUE OR FALSE

CIRCLE THE CORRECT WORDS:

3. They "had seen all the (**GREAT**, **SMALL**) works of the LORD which He had done for Israel."
JUDGES 2:7
4. "Now Joshua the son of Nun, the (**SERVANT**, **ENEMY**) of the LORD, died when he was one hundred and ten years old." **JUDGES 2:8**

FILL IN THE BLANK:

5. "And they buried him within the borders of _____ inheritance." **JUDGES 2:9**

CIRCLE THE CORRECT WORD:

6. "When all that generation had been gathered to their fathers, another generation arose after them who (**DID**, **DID NOT**) know the LORD." **JUDGES 2:10**

TRUE OR FALSE:

7. The next generation knew the work which the LORD had done for Israel. **JUDGES 2:10**
TRUE OR FALSE

60. JOSHUA DIES

(JUDGES 2:7-10)

F N U N N M J S E R V A N T Z
L L O J F D U L G O D A X Z N
J E D I E V E P K P Y U N M N
I S A V T K R O J O S H U A O
I F R R U A R W D E I R U B L
D E F H S V R K J I T Y F E Y
S I M W M I U E Q W R S H B O
W V E Y A Z L V N W R I N K W
M P O D D Y H D V E H W N K I
C E E J P C F E R J G O D Y P
W L L L Z Q S E Y O W F P Q T
O P D S D K A L Y Q L F L Y U
R O E G I P Y W C F T E R O M
K E R O E C N A T I R E H N I
S P S S O A G Z A R Y W V Q F

BURIED
DIED
ELDERS
GENERATION
GOD

INHERITANCE
ISRAEL
JOSHUA
KNOW
LORD

PEOPLE
SERVANT
SERVED
WORKS

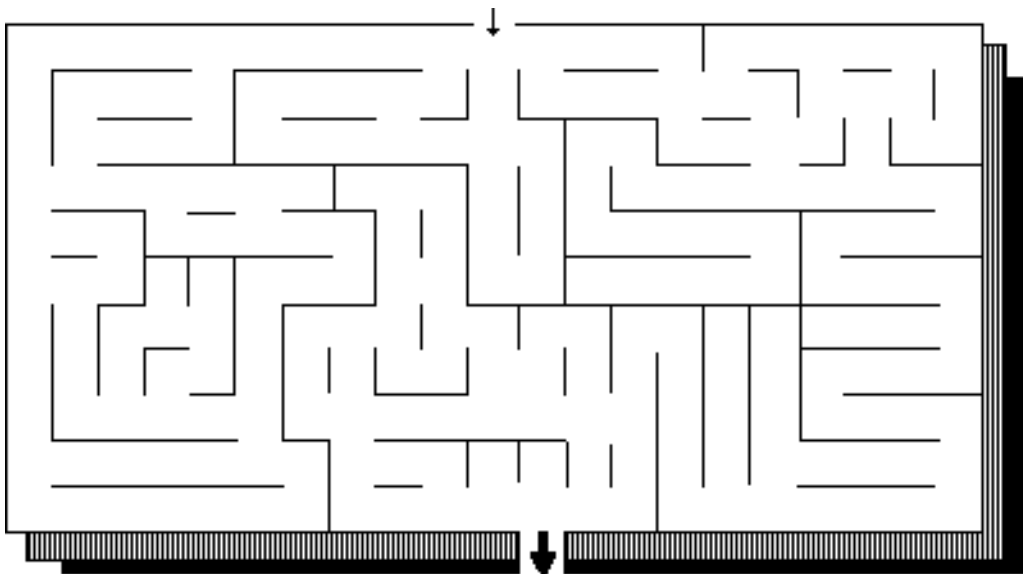

60. JOSHUA DIES

(JUDGES 2:7-10)

MEMORY VERSE:

"You have seen all that the LORD your God has done to all these nations because of you, for the LORD your God is He who has fought for you." JOSHUA 23:3

FILL IN THE BLANK:

1. "The people served the LORD all the days of _____." JUDGES 2:7

TRUE OR FALSE:

2. And the people served the LORD "all the days of the elders who outlived Joshua." JUDGES 2:7
TRUE OR FALSE

FILL IN THE BLANKS:

3. They "had seen all the _____ of the LORD which He had done for Israel."
JUDGES 2:7
4. "Now Joshua the son of Nun, the _____ of the LORD, died when he was one hundred and ten years old." JUDGES 2:8

UNDERLINE THE CORRECT ANSWER:

5. "And they buried him within the borders of his inheritance..." JUDGES 2:9
- a. at Timnath Heres
 - b. in the mountains of Ephraim
 - c. on the north side of Mount Gaash
 - d. all of the above

FILL IN THE BLANKS:

6. "When all that generation had been gathered to their fathers, another generation arose after them who _____ know the LORD." JUDGES 2:10

TRUE OR FALSE:

7. The next generation knew the work which the LORD had done for Israel. JUDGES 2:10
TRUE OR FALSE

60. JOSHUA DIES

(JUDGES 2:7-10)

M O E F J I N J D C L M Z J W H L S Q I
 S D G D R T W G E Z F C Y F G Q V D A T
 T U E M C Z Q S M W N W S J Z O O E V R
 T I N O Q Q S B K K N O W E Y J C D O G
 C R E Z F I S R A E L D C W T N T H E V
 C A R E Y Y D I T L Q N H Q R G Z A L I
 P A A M T H E P B K A C R U L A O R D W
 K W T L H Q D U D T Y V V J U E E O E O
 J F I V G S L C I I K S I N K S P T R R
 V C O Q U E S R B B R R H N U E J R S K
 B Q N O O N E E N A V Q H V P Q Z H U S
 J U W N F H N U L K U S E R V E D G D K
 C O R J N R D I E D P B R J T P J J L D
 Y X S I M F J L V S F C P T H A H H Z D
 Q G S H E D R T V G M T N Z S B F D N O
 O Y D H U D H J F M A A L A D P R H G C
 L I H W C A K T W W V C O D E L P O E P
 T E C D E P H E G R Q N R S L S K P K J
 Y S N H T A P A E H X L D D B T Y N V A
 V D R M G F L S L K P O Z Z U Y S W E S

BURIED
 DIED
 ELDERS
 FOUGHT
 GENERATION

GOD
 INHERITANCE
 ISRAEL
 JOSHUA
 KNOW

LORD
 PEOPLE
 SERVANT
 SERVED
 WORKS

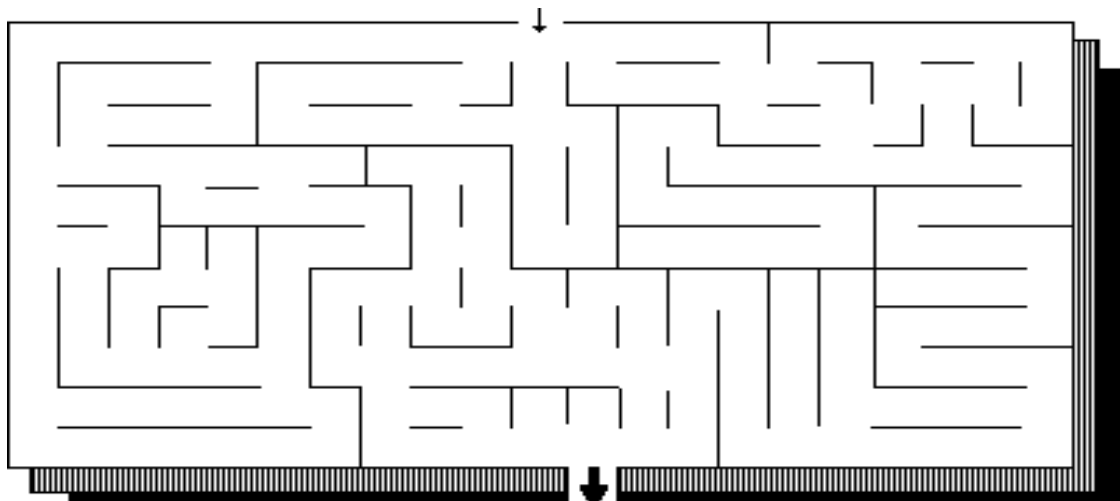

60. JOSHUA DIES

(JUDGES 2:7-10)

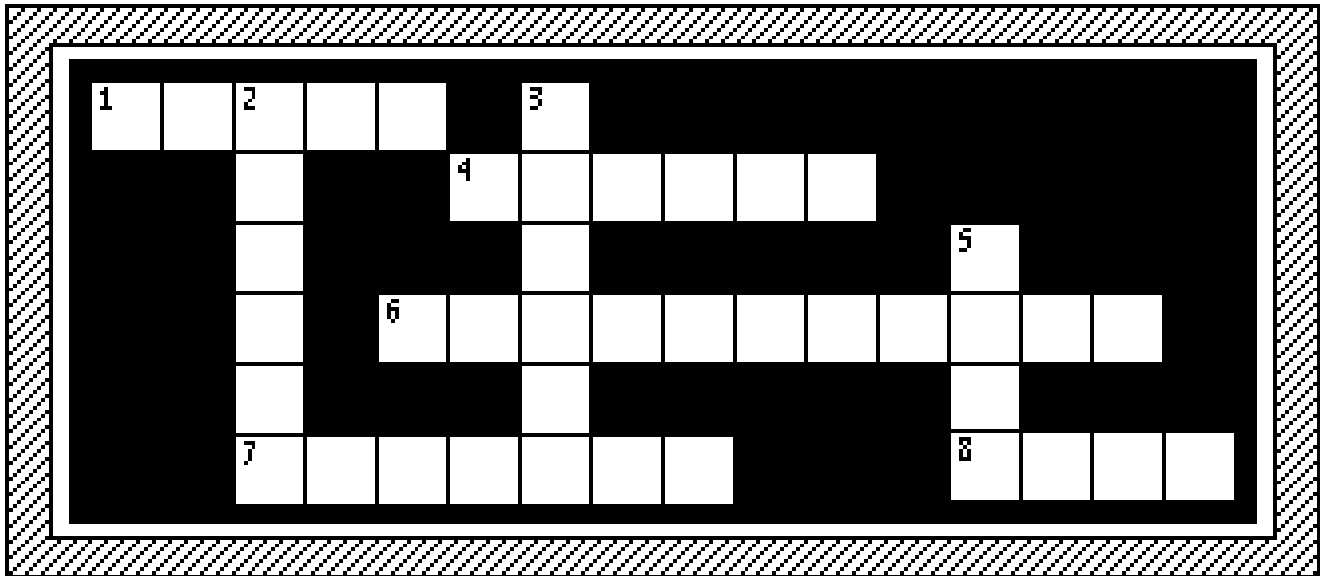

- 4 ACROSS "You have seen all that the LORD your God has done to all these nations because of you, for the LORD your God is He who has _____ for you." **JOSHUA 23:3**
- 3 DOWN "The people served the LORD all the days of _____." **JUDGES 2:7**
- 2 DOWN And the people served the LORD "all the days of the _____ who outlived Joshua." **JUDGES 2:7**
- 1 ACROSS They "had seen all the _____ works of the LORD which He had done for Israel." **JUDGES 2:7**
- 7 ACROSS "Now Joshua the son of Nun, the _____ of the LORD, died when he was one hundred and _____ ten years old." **JUDGES 2:8**
- 6 ACROSS "And they buried him within the borders of his _____." **JUDGES 2:9**
- 5 DOWN "When all that generation had been gathered to their fathers, another generation arose after them who did not _____ the LORD." **JUDGES 2:10**
- 8 ACROSS The next generation did not know "the _____ which the LORD had done for Israel." **JUDGES 2:10**

Bible Story 61

DEBORAH

JUDGES 4:1-23

61. DEBORAH

(JUDGES 4:1-23)



"And Deborah, a prophetess, the wife of Lapidoth, she judged Israel at that time."
JUDGES 4:4

61. DEBORAH

(JUDGES 4:1-23)

MEMORY VERSE:

"When the leaders lead in Israel, when the people willingly offer themselves, bless the LORD!" JUDGES 5:2

FILL IN THE BLANK:

1. "The children of Israel cried out to the LORD; for Jabin had nine hundred _____ of iron, and for twenty years he harshly oppressed the children of Israel." **JUDGES 4:3**

CIRCLE THE CORRECT WORDS:

2. "Now (**DANDELION, DEBORAH**), a prophetess, the wife of Lapidoth, was (**JUDGING, VISITING**) Israel at that time." **JUDGES 4:4**
3. "And she would sit under the (**PINE, PALM**) tree of Deborah between Ramah and Bethel in the mountains of Ephraim." **JUDGES 4:5**
4. "And the children of Israel came up to her for (**JUDGMENT, FOOD**)." **JUDGES 4:5**
5. "She sent and called for (**BARBAR, BARAK**) the son of Abinoam from Kedesh in Naphtali, and said to him, 'Has not the LORD God of Israel commanded, saying, "Go and deploy troops at Mount Tabor; take with you ten thousand men of the sons of (**THUNDER, NAPHTALI**) and the sons of Zebulun?" ' " **JUDGES 4:6**
6. "And against you I will deploy (**SISSY, SISERA**), the commander of Jabin's army, with his chariots and his multitude at the River Kishon; and I will deliver him into your hand?" **JUDGES 4:7**

TRUE OR FALSE:

7. "Barak said to her, 'If you will go with me, then I will go; but if you will not go with me, I will not go.' " **JUDGES 4:8**

TRUE OR FALSE

8. So she said, "I surely will not go with you!" **JUDGES 4:9**
TRUE OR FALSE

FILL IN THE BLANK:

9. "So on that day _____ subdued Jabin king of Canaan in the presence of the children of Israel." **JUDGES 4:23**

61. DEBORAH

(JUDGES 4:1-23)

N A P H T A L I J U D G E W G
 B N J C U J Z E B U L U N J R
 L G L V L K H R B K I C A X K
 L I E G S S L O W E O B X L Z
 N C O B T M S J B O I U M A L
 M N R A O D D E V N V V R R X
 Z E I R I O I L T J M E G Q I
 S B Y A R F P L B E S N Q C V
 S P S K A P M A D I H V O R V
 O U Y W H Q W G S E G P T H T
 N M D H C R L H H S B M O N L
 G R Y H Y K G G C Z D O H R C
 V J B B L D S N O N O U R N P
 M Z O X H F Z W Y W T O K A M
 O F J B B S U B D U E D W V H

BARAK	JUDGE	SONG
CHARIOTS	NAPHTALI	SUBDUED
DEBORAH	PROPHETESS	ZEBULUN
JABIN	SISERA	

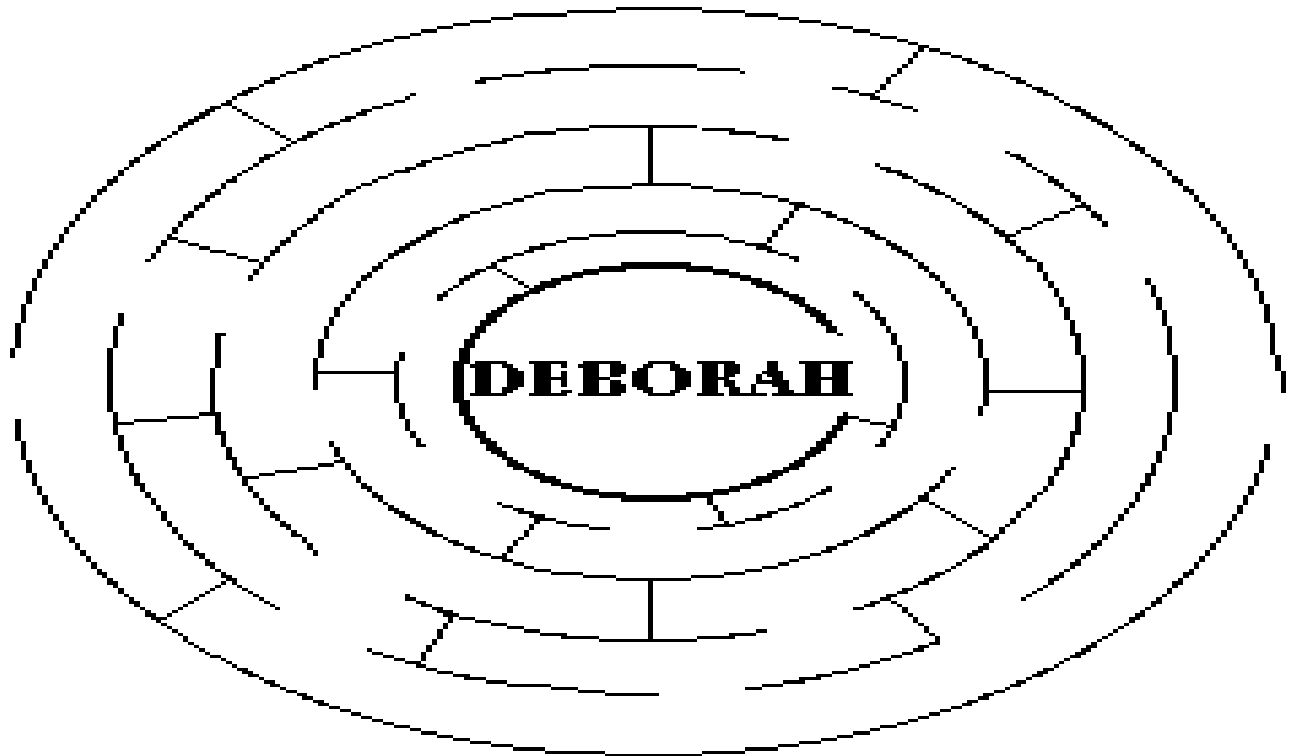

61. DEBORAH

(JUDGES 4:1-23)

MEMORY VERSE:

""When the leaders lead in Israel, when the people willingly offer themselves, bless the LORD!" JUDGES 5:2

FILL IN THE BLANKS:

1. "The children of Israel cried out to the LORD; for Jabin had nine hundred _____ of iron, and for twenty years he harshly oppressed the children of Israel." **JUDGES 4:3**
2. "Now _____, a prophetess, the wife of Lapidoth, was _____ Israel at that time." **JUDGES 4:4**
3. "And she would sit under the _____ tree of Deborah between Ramah and Bethel in the mountains of Ephraim." **JUDGES 4:5**
4. "And the children of Israel came up to her for _____." **JUDGES 4:5**
5. "She sent and called for _____ the son of Abinoam from Kedesh in Naphtali, and said to him, 'Has not the LORD God of Israel commanded, saying, "Go and deploy troops at Mount Tabor; take with you ten thousand _____ men of the sons of _____ and the sons of Zebulun?" ' " **JUDGES 4:6**

CIRCLE THE CORRECT WORD:

6. "And against you I will deploy (**SISSY, SISERA**), the commander of Jabin's army, with his chariots and his multitude at the River Kishon; and I will deliver him into your hand?" **JUDGES 4:7**

TRUE OR FALSE:

7. "Barak said to her, 'If you will go with me, then I will go; but if you will not go with me, I will not go.' " **JUDGES 4:8**

TRUE OR FALSE

8. So she said, "I surely will not go with you!" **JUDGES 4:9**

TRUE OR FALSE

FILL IN THE BLANK:

9. "So on that day _____ subdued Jabin king of Canaan in the presence of the children of Israel." **JUDGES 4:23**

61. DEBORAH

(JUDGES 4:1-23)

Q C R V Y Y W L Z V F G X V S L P Y K S
 H P D S T L G O I N B P P T T K K G I O
 Y E Y L E N F U I P L C R O V I R S Y P
 O K Q B J D Z P D Y A V E J G Q E M H D
 F Y Q A Z C A D E U D B U S W R E R F Q
 G B B M Q V N S O N G N M Q A S N U Q J
 Q I H I V S S W Z G A U H L D S A V V J
 N Z F N L O S C P P E I Y P K O I E H C
 C U O U S S H E H N Z P Y V A E C Z M P
 F F I L R K U T T W C N M G G H P U G V
 C J H U S L A P Z E L S B Y A Z Q U Q D
 J U H B B L S R V Y H C P R S P F I W I
 K B Q E I D Y F U M W P I Q A E R M G M
 V X A Z B F J M D U C O O D L P C Q P O
 O K U R Z A N E W G T N R R D V G B W O
 E B L O A B D T E S A P Y O P F O V D F
 B G U B G K H A R O B E D O S I W B I M
 Y D D P W R Y L E F Z C R K Y U J W C D
 D C M U L H I M B Y S M E P L H V Y P I
 G Z N E J E B E D I D C M Z F I H U L V

BARAK
 CHARIOTS
 DEBORAH
 JABIN

JUDGE
 NAPHTALI
 PROPHETESS
 SISERA

SONG
 SUBDUED
 ZEBULUN

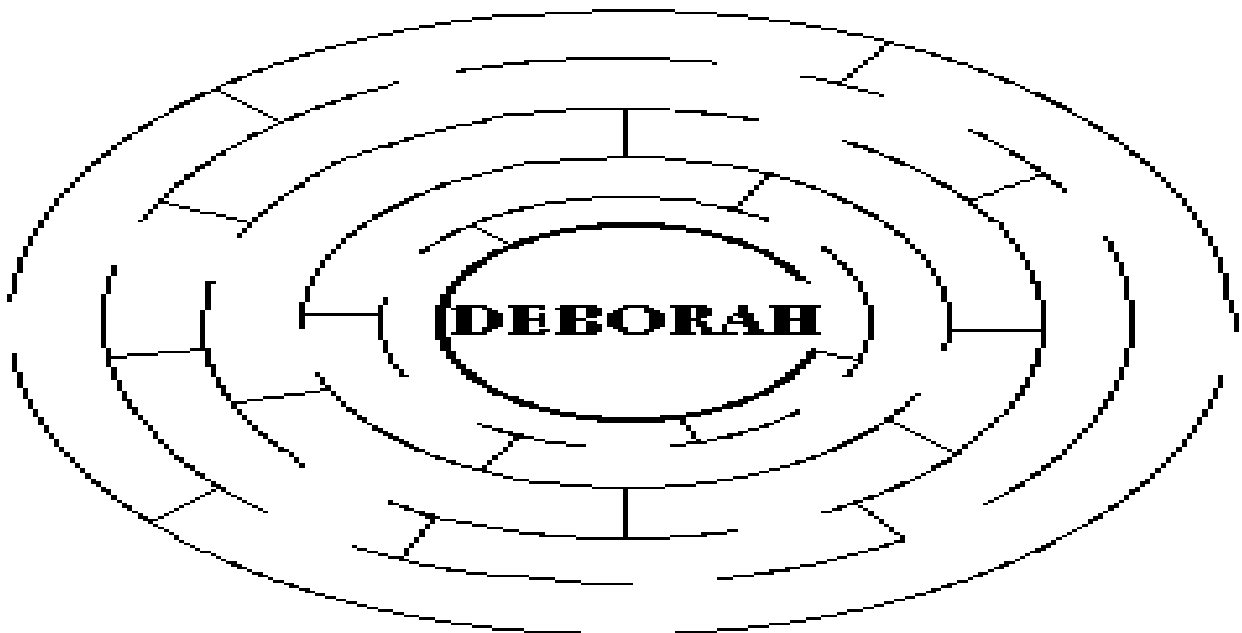

61. DEBORAH

(JUDGES 4:1-23)

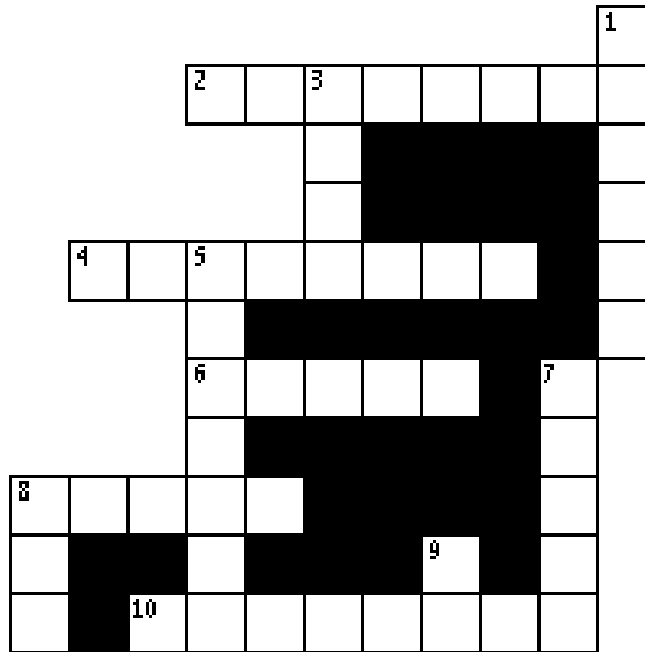

- 10 ACROSS "The children of Israel cried out to the LORD; for Jabin had nine hundred _____ of iron, and for twenty years he harshly oppressed the children of Israel." **JUDGES 4:3**
- 5 DOWN "Now _____, a prophetess, the wife of Lapidoth, was judging Israel at that time." **JUDGES 4:4**
- 3 DOWN "And she would sit under the _____ tree of Deborah between Ramah and Bethel in the mountains of Ephraim." **JUDGES 4:5**
- 4 ACROSS "And the children of Israel came up to her for _____." **JUDGES 4:5**
- 6 ACROSS "She sent and called for _____ the son of Abinoam from Kedesh in Naphtali." **JUDGES 4:6**
- 2 ACROSS She said to him, "Has not the LORD God of Israel commanded, saying, 'Go and deploy troops at Mount Tabor; take with you ten thousand men of the sons of _____ and the sons of Zebulun?' " **JUDGES 4:6**
- 1 DOWN "And against you I will deploy _____, the commander of Jabin's army, with his chariots and his multitude at the River Kishon; and I will deliver him into your hand?" **JUDGES 4:7**
- 9 DOWN "Barak said to her, 'If you will _____ with me, then I will go; but if you will not go with me, I will not go.' " **JUDGES 4:8**
- 8 ACROSS "So she said, 'I surely will go with you; nevertheless there will be no _____ for you in the journey you are taking.' " **JUDGES 4:9**
- 8 DOWN "So on that day _____ subdued Jabin king of Canaan in the presence of the children of Israel." **JUDGES 4:23**
- 7 DOWN "When the leaders lead in Israel, when the people willingly offer themselves, _____ the LORD!" **JUDGES 5:2**

Bible Story 62

THE CALLING OF GIDEON

JUDGES 6:11-40

62. THE CALLING OF GIDEON

(JUDGES 6:11-40)



"And Gideon said unto God, If thou wilt save Israel by mine hand, as thou hast said, behold, I will put a fleece of wool in the floor; *and* if the dew be on the fleece only, and *it* be dry upon all the earth *beside*, then shall I know that thou wilt save Israel by mine hand, as thou hast said."

JUDGES 6:36-37

62. THE CALLING OF GIDEON (JUDGES 6:11-40)

MEMORY VERSE:

"And the LORD said to him, 'Surely I will be with you, and you shall defeat the Midianites as one man.'" JUDGES 6:16

FILL IN THE BLANK:

1. "Now the Angel of the LORD came and sat under the terebinth tree which was in Ophrah, which belonged to Joash the Abiezrite, while his son _____ threshed wheat in the winepress, in order to hide it from the Midianites." JUDGES 6:11

TRUE OR FALSE:

2. "And the Angel of the LORD appeared to him, and said to him, 'The LORD is with you, you mighty man of valor!'" JUDGES 6:12

TRUE OR FALSE

CIRCLE THE CORRECT WORDS:

3. "Then the LORD turned to him and said, 'Go in this (**MIGHT**, **SIGHT**) of yours, and you shall (**SAVE**, **LOSE**) Israel from the hand of the Midianites. Have I not sent you?'" JUDGES 6:14
4. "So he said to Him, 'O my Lord, how can I save Israel? Indeed my clan is the (**STRONGEST**, **WEAKEST**) in Manasseh, and I am the (**LEAST**, **GREATEST**) in my father's house.'" JUDGES 6:15
5. "And the LORD said to him, 'Surely I will be with you, and you shall (**SEE**, **DEFEAT**) the Midianites as one man.'" JUDGES 6:16

TRUE OR FALSE:

6. "Now it came to pass the same night that the LORD said to him, 'Take your father's young bull, the second bull of seven years old, and tear down the altar of Baal that your father has, and cut down the wooden image that is beside it.'" JUDGES 6:25

TRUE OR FALSE

FILL IN THE BLANK:

7. The LORD also said, "Build an altar to the LORD your God on top of this rock in the proper arrangement, and take the second bull and offer a burnt _____ with the wood of the image which you shall cut down." JUDGES 6:26

CIRCLE THE CORRECT WORDS:

8. "Gideon said to God, 'If You will save Israel by my hand as You have said-- look, I shall put a (**PIECE**, **FLEECE**) of wool on the threshing floor.'" JUDGES 6:36-37
9. "If there is dew on the fleece (**ONLY**, **ALSO**), and it is dry on the ground, then I shall (**KNOW**, **GUESS**) that You will save Israel by my hand, as You have said.'" JUDGES 6:37
10. "And it was so. When he rose early the next morning and squeezed the fleece together, he wrung the dew out of the fleece, a bowl (**FULL**, **EMPTY**) of water." JUDGES 6:38
11. "Then Gideon said to God, 'Do not be angry with me, and let me speak just once more: Let me test, I pray, just once more with the fleece; let it now be (**DRY**, **DUSTY**) only on the fleece, but on the ground let there be dew.'" JUDGES 6:39
12. "And God did so that night. It was dry on the fleece only, but there was (**DIRT**, **DEW**) on all the ground." JUDGES 6:40

62. THE CALLING OF GIDEON

(JUDGES 6:11-40)

A V A L O R I L K Q W U Y W D
 S N T K D Y E G R N W F L Q W
 M Q G B W A A H E Y Z L D N T
 J X T E R F R R N M O Y F I L
 T N R S L O W D C F L E E C E
 A A I E K O I V V A A D E W A
 R Y R T I J F G C S K H B S O
 A Q W I E W F T N V U R E V A
 T U P N P E U B H I N O H U P
 L Y N A I G T G C E R L A A B
 A R T I B A I C H Y L E T U A
 A D S D B M O D R K U O F A D
 U Q A I B I M Z E W D I R F Y
 E T E M P S J H E O L R L D O
 N H L C P S K K M L N F U D S

ALTAR
 ANGEL OF THE LORD
 BAAL
 DEW
 DRY

FLEECE
 GIDEON
 IMAGE
 ISRAEL

LEAST
 MIDIANITES
 OFFERING
 VALOR

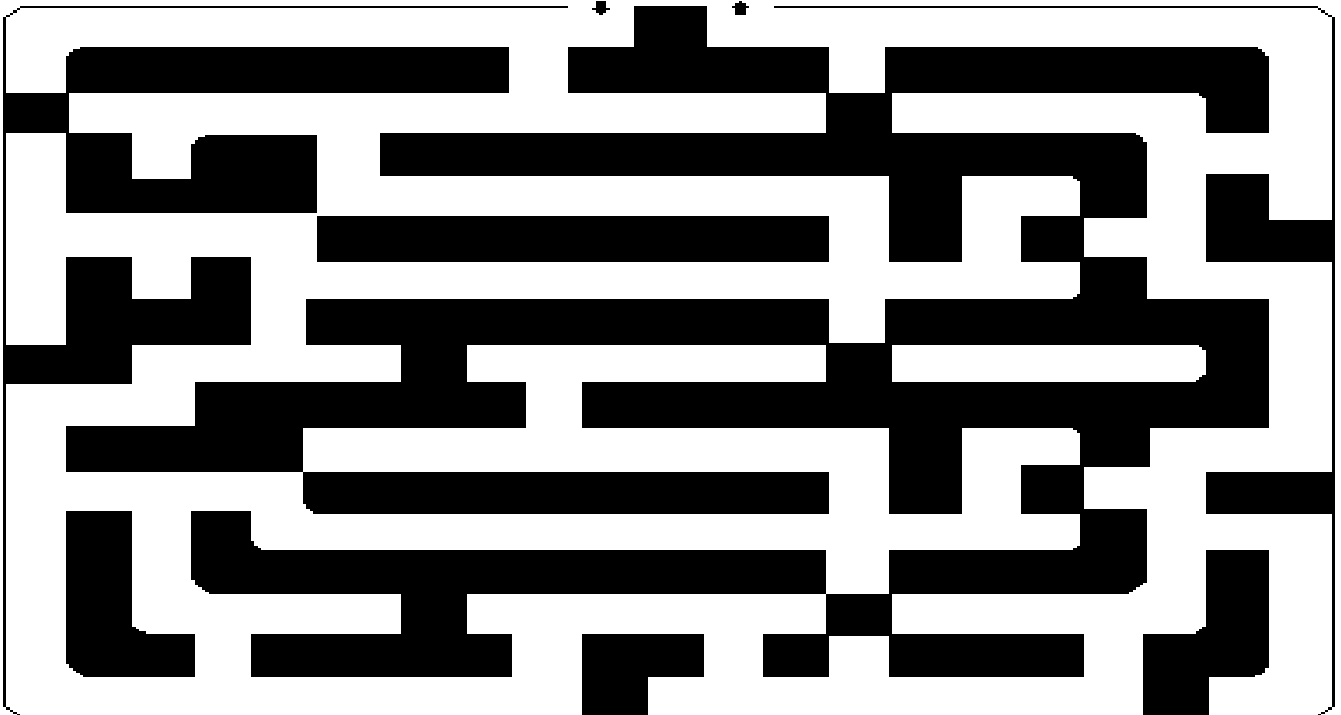

62. THE CALLING OF GIDEON

(JUDGES 6:11-40)

MEMORY VERSE:

"And the LORD said to him, 'Surely I will be with you, and you shall defeat the Midianites as one man.'" JUDGES 6:16

FILL IN THE BLANK:

1. "Now the Angel of the LORD came and sat under the terebinth tree which was in Ophrah, which belonged to Joash the Abiezrite, while his son _____ threshed wheat in the winepress, in order to hide it from the Midianites." JUDGES 6:11

TRUE OR FALSE:

2. "And the Angel of the LORD appeared to him, and said to him, 'The LORD is with you, you mighty man of valor!'" JUDGES 6:12

TRUE OR FALSE

FILL IN THE BLANKS:

3. "Then the LORD turned to him and said, 'Go in this _____ of yours, and you shall _____ Israel from the hand of the Midianites. Have I not sent you?'" JUDGES 6:14
4. "So he said to Him, 'O my Lord, how can I save Israel? Indeed my clan is the _____ in Manasseh, and I am the _____ in my father's house.'" JUDGES 6:15
5. "And the LORD said to him, 'Surely I will be with you, and you shall _____ the Midianites as one man.'" JUDGES 6:16

TRUE OR FALSE:

6. "Now it came to pass the same night that the LORD said to him, 'Take your father's young bull, the second bull of seven years old, and tear down the altar of Baal that your father has, and cut down the wooden image that is beside it.'" JUDGES 6:25

TRUE OR FALSE

FILL IN THE BLANK:

7. The LORD also said, "Build an altar to the LORD your God on top of this rock in the proper arrangement, and take the second bull and offer a burnt _____ with the wood of the image which you shall cut down." JUDGES 6:26

CIRCLE THE CORRECT WORDS:

8. "Gideon said to God, 'If You will save Israel by my hand as You have said-- look, I shall put a (PIECE, FLEECE) of wool on the threshing floor.'" JUDGES 6:36-37
9. "If there is dew on the fleece (ONLY, ALSO), and it is dry on the ground, then I shall (KNOW, GUESS) that You will save Israel by my hand, as You have said.'" JUDGES 6:37
10. "And it was so. When he rose early the next morning and squeezed the fleece together, he wrung the dew out of the fleece, a bowl (FULL, EMPTY) of water." JUDGES 6:38

FILL IN THE BLANKS:

11. "Then Gideon said to God, 'Do not be angry with me, and let me speak just once more: Let me test, I pray, just once more with the fleece; let it now be _____ only on the fleece, but on the ground let there be dew.'" JUDGES 6:39
12. "And God did so that night. It was dry on the fleece only, but there was _____ on all the ground." JUDGES 6:40

62. THE CALLING OF GIDEON

(JUDGES 6:11-40)

C J H K R K P F U Z W N Y J W S N X H A
 J U H E S L S M D U C S D Q D O A U L P
 K X Q Y B D Y E W R A C R L K E I T F D
 V K U T L F J T E F Z N Y P A Z A V Q Q
 O B F E B A N N O E D I G V G R P E X J
 B D A E Z B D B A A L M Y G S P Q Z H J
 Y S U Z F D Y L E Y I P D R A E R U M C
 T C M L W R R M B D S E M Q U U R U G X
 D Z N E M M I O I I W C B D K V O I Q V
 G R V A Y E B A L F D X P O S F C L W D
 C D S R L W N E D E G C R O F F G Q G I
 N Y L S N I L Z V B H X Y E Y I O B X M
 E I B I T G O I N L P T R K M U W V W O
 K Q M E D F U I P A C I F P F H J B D O
 Y Q S A C Z P D Y E N P R O L I V W I F
 R H M Q G A W Z G G V R E Z L P H Y C M
 B O I V V E E C E E L F M S K E Y U P D
 Z F L L O N C P N Z U E V T I K G K L I
 U O O A S S P Z W C I M T V Q R G N O V
 F I X S V H R V Y L P H O G S E M Y A E

ALTAR
ANGEL OF THE LORD
BAAL
DEW
DRY

FLEECE
GIDEON
IMAGE
ISRAEL

LEAST
MIDIANITES
OFFERING
VALOR

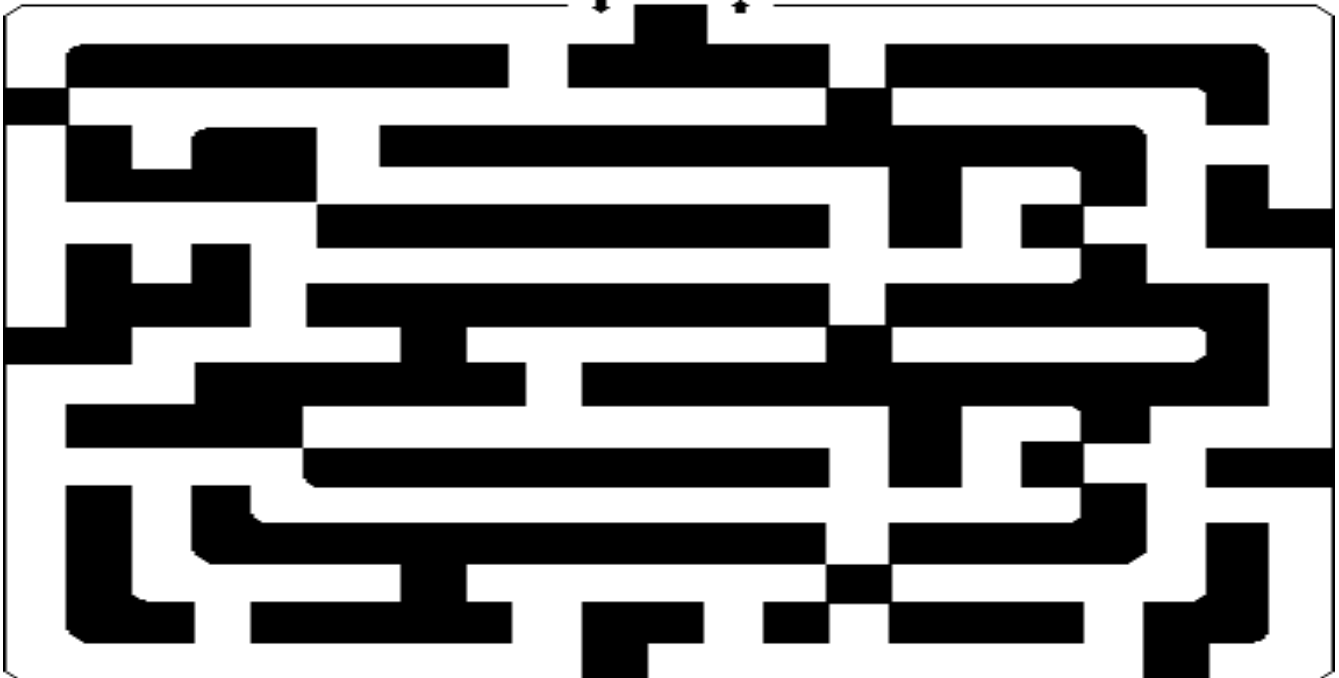

62. THE CALLING OF GIDEON (JUDGES 6:11-40)

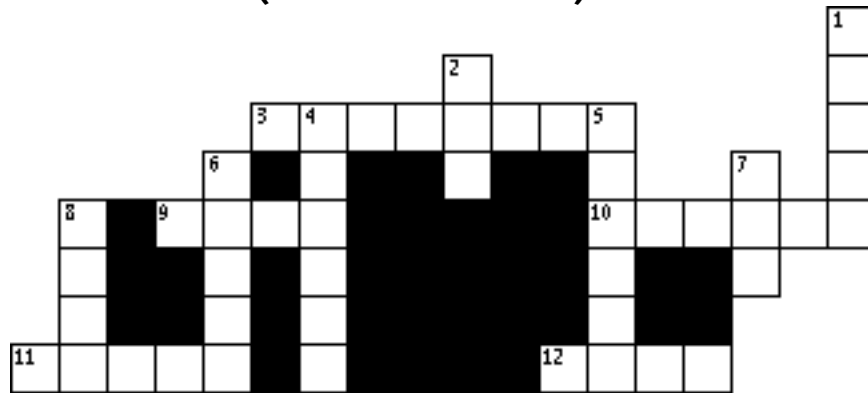

- 5 DOWN "Now the Angel of the LORD came and sat under the terebinth tree which was in Ophrah, which belonged to Joash the Abiezrite, while his son _____ threshed wheat in the winepress, in order to hide it from the Midianites." **JUDGES 6:11**
- 6 DOWN "And the Angel of the LORD appeared to him, and said to him, 'The LORD is with you, you mighty man of _____!' " **JUDGES 6:12**
- 9 ACROSS "Then the LORD turned to him and said, 'Go in this might of yours, and you shall _____ Israel from the hand of the Midianites. Have I not sent you?' " **JUDGES 6:14**
- 1 DOWN "So he said to Him, 'O my Lord, how can I save Israel? Indeed my clan is the strongest in Manasseh, and I am the _____ in my father's house.' " **JUDGES 6:15**
- 10 ACROSS "And the LORD said to him, 'Surely I will be with you, and you shall _____ the Midianites as one man.' " **JUDGES 6:16**
- 11 ACROSS "Now it came to pass the same night that the LORD said to him, 'Take your father's young bull, the second bull of seven years old, and tear down the _____ of Baal that your father has, and cut down the wooden image that is beside it.' " **JUDGES 6:25**
- 3 ACROSS The LORD also said, "Build an altar to the LORD your God on top of this rock in the proper arrangement, and take the second bull and offer a burnt _____ with the wood of the image which you shall cut down." **JUDGES 6:26**
- 4 DOWN "Gideon said to God, 'If You will save Israel by my hand as You have said-- look, I shall put a _____ of wool on the threshing floor.' " **JUDGES 6:36-37**
- 12 ACROSS "If there is dew on the fleece only, and it is dry on the ground, then I shall _____ that You will save Israel by my hand, as You have said.' " **JUDGES 6:37**
- 8 DOWN "And it was so. When he rose early the next morning and squeezed the fleece together, he wrung the dew out of the fleece, a bowl _____ of water." **JUDGES 6:38**
- 2 DOWN "Then Gideon said to God, 'Do not be angry with me, and let me speak just once more: Let me test, I pray, just once more with the fleece; let it now be _____ only on the fleece, but on the ground let there be dew.' " **JUDGES 6:39**
- 7 DOWN "It was dry on the fleece only, but there was _____ on all the ground." **JUDGES 6:40**

Bible Story 63

GIDEON'S ARMY OF 300

JUDGES 7:1-25

63. GIDEON'S ARMY OF 300 (JUDGES 7:1-25)



"And the three companies blew the trumpets, and brake the pitchers, and held the lamps in their left hands, and the trumpets in their right hands to blow *withal*: and they cried, The sword of the LORD, and of Gideon."

JUDGES 7:20

63. GIDEON'S ARMY OF 300

(JUDGES 7:1-25)

MEMORY VERSE:

"Then it will be, that of whom I say to you, 'This one shall go with you,' the same shall go with you; and of whomever I say to you, 'This one shall not go with you,' the same shall not go." JUDGES 7:4

CIRCLE THE CORRECT WORDS:

1. "The LORD said to Gideon, 'The people who are with you are too (**MANY, FEW**) for Me to give to the Midianites into their hands, lest Israel claim glory for itself against Me, saying, "My own hand has saved me." ' " **JUDGES 7:2**
2. The LORD then said to Gideon, "Now therefore proclaim in the hearing of the people, saying, 'Whoever is fearful and afraid, let him turn and (**FIGHT, DEPART**) at once from Mount Gilead.' " **JUDGES 7:3**

TRUE OR FALSE:

3. "And twenty-two thousand of the people returned, and ten thousand remained." **JUDGES 7:3**
TRUE OR FALSE
4. And the LORD said to Gideon, "Now the people are too few!" **JUDGES 7:4**
TRUE OR FALSE

MATCHING:

DRAW A LINE FROM WHAT THE LORD HAS SAID TO DO TO THE CORRECT RESPONSE ON THE RIGHT-

5. The LORD said, "Bring them down to the water, and I will test them for you there. Then it will be, that of whom I say to you..." **JUDGES 7:4**

THIS ONE SHALL GO WITH YOU

THE SAME SHALL NOT GO

THIS ONE SHALL NOT GO WITH YOU

THE SAME SHALL GO WITH YOU

TRUE OR FALSE:

6. "So he brought the people down to the water. And the LORD said to Gideon, 'Everyone who laps from the water with his tongue, as a dog laps, you shall set apart by himself.' " **JUDGES 7:5**
TRUE OR FALSE
7. "Likewise everyone who gets down on his knees to drink." **JUDGES 7:5**
TRUE OR FALSE

FILL IN THE BLANK:

8. "And the number of those who lapped, putting their hand to their mouth, was three _____ men; but all the rest of the people got down on their knees to drink water." **JUDGES 7:6**

TRUE OR FALSE:

9. "Then the LORD said, 'By the three hundred men who lapped I will save you, and deliver the Midianites into your hand.' " **JUDGES 7:7**
TRUE OR FALSE

CIRCLE THE CORRECT WORDS:

10. "And it happened on the same night that the LORD said to him, 'Arise, go down against the camp, for I have (**DELIVERED, REMOVED**) it into your hand.' " **JUDGES 7:9**
11. Gideon's "three companies blew the (**FLUTES, TRUMPETS**) and broke the (**PITCHERS, ARROWS**)- they held the torches in their left hands and the trumpets in their right hands for blowing-- and they cried, 'The sword of the LORD and of Gideon!' And every man stood in his place all around the camp; _____ and the whole army ran and cried out and fled." **JUDGES 7:20-21**

63. GIDEON'S ARMY OF 300 (JUDGES 7:1-25)

T T R R N W O N G M X Q V K S
 O O K O W B M W D U L C V M C
 O R D J B V I I O O R R T P T
 M C F L D W D O T X D H L E P
 A H H G E A I V C L A N C I M
 N E L I R T A S U M E N M P S
 Y S D D D E N T V G L A S L D
 H K I E N R I E D Q I V R E Q
 L K P O U B T P R O G G E S H
 A X M N H H E M I T T R H P I
 P D W L E C S U N H N P C K E
 P O L A E O J R K K U Z T S N
 E F G G R Y S T N W O L I N P
 D P S H H K Z M V W M P P U T
 X Q Z G T E K N E E S I G W L

DRINK
 GIDEON
 ISRAEL
 KNEES
 LAPPED

MIDIANITES
 MOUNT GILEAD
 PITCHERS
 THREE HUNDRED

TOO MANY
 TORCHES
 TRUMPETS
 WATER

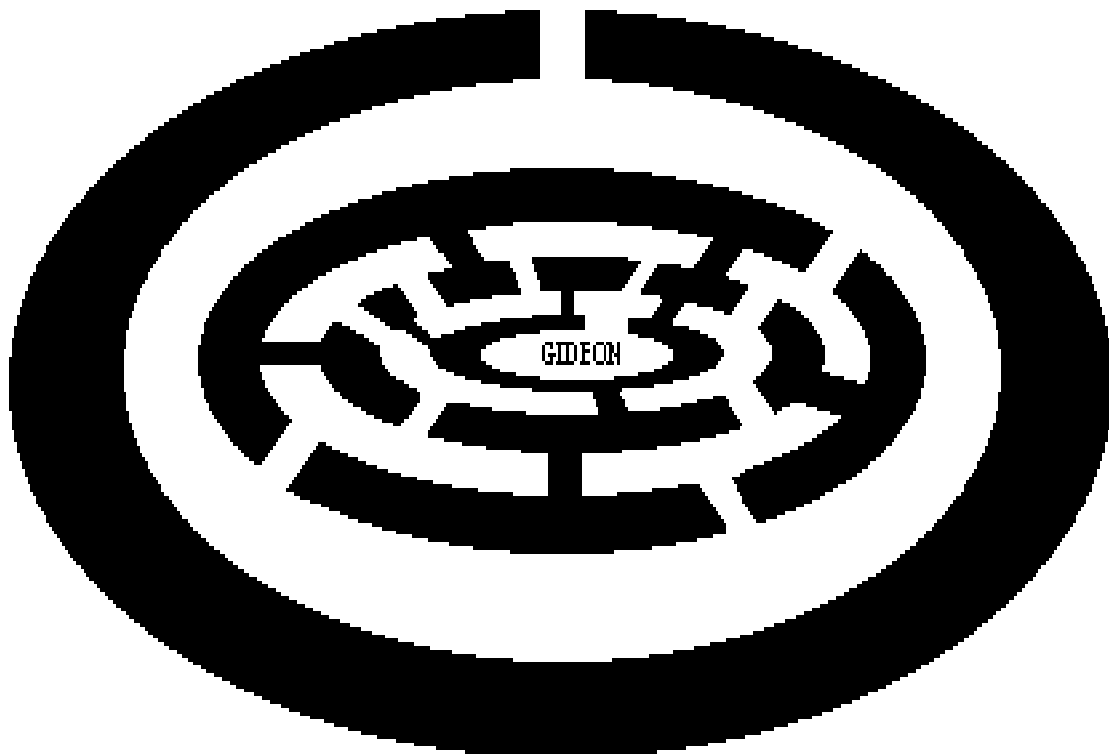

63. GIDEON'S ARMY OF 300

(JUDGES 7:1-25)

MEMORY VERSE:

"Then it will be, that of whom I say to you, 'This one shall go with you,' the same shall go with you; and of whomever I say to you, 'This one shall not go with you,' the same shall not go." JUDGES 7:4

FILL IN THE BLANKS:

1. "The LORD said to Gideon, 'The people who are with you are too _____ for Me to give to the Midianites into their hands, lest Israel claim glory for itself against Me, saying, "My own hand has saved me." ' "
JUDGES 7:2
2. The LORD then said to Gideon, "Now therefore proclaim in the hearing of the people, saying, 'Whoever is fearful and afraid, let him turn and _____ at once from Mount Gilead.'" JUDGES 7:3
3. "And twenty-two thousand of the people returned, and _____ thousand remained." JUDGES 7:3

TRUE OR FALSE:

4. And the LORD said to Gideon, "Now the people are too few!" JUDGES 7:4
TRUE OR FALSE

MATCHING:

DRAW A LINE FROM WHAT THE LORD HAS SAID TO DO TO THE CORRECT RESPONSE ON THE RIGHT-

5. The LORD said, "Bring them down to the water, and I will test them for you there. Then it will be, that of whom I say to you..." JUDGES 7:4

THIS ONE SHALL GO WITH YOU

THE SAME SHALL NOT GO

THIS ONE SHALL NOT GO WITH YOU

THE SAME SHALL GO WITH YOU

TRUE OR FALSE:

6. "So he brought the people down to the water. And the LORD said to Gideon, 'Everyone who laps from the water with his tongue, as a dog laps, you shall set apart by himself.' " JUDGES 7:5
TRUE OR FALSE
7. "Likewise everyone who gets down on his knees to drink." JUDGES 7:5
TRUE OR FALSE

FILL IN THE BLANK:

8. "And the number of those who lapped, putting their hand to their mouth, was three _____ men; but all the rest of the people got down on their knees to drink water." JUDGES 7:6

TRUE OR FALSE:

9. "Then the LORD said, 'By the three hundred men who lapped I will save you, and deliver the Midianites into your hand.' " JUDGES 7:7

TRUE OR FALSE

FILL IN THE BLANKS:

10. "And it happened on the same night that the LORD said to him, 'Arise, go down against the camp, for I have _____ it into your hand.' " JUDGES 7:9
11. Gideon's "three companies blew the _____ and broke the _____ - they held the torches in their left hands and the trumpets in their right hands for blowing-- and they cried, 'The sword of the LORD and of Gideon!' And every man stood in his place all around the camp; and the whole army ran and cried out and fled." JUDGES 7:20-21

63. GIDEON'S ARMY OF 300 (JUDGES 7:1-25)

N Q T Y A I J P Y O W B P C O A J U A Q
 S S E H C R O T O J Y D N U I H C D R L
 Z I A L W W T I F J P T S M T A V S L K
 K P Q I T Z E Q V E Z O U R E H T J W D
 B K N E E S J D X A W O O D E Z W H J D
 Z H S E T I N A I D I M F L J H H Q U O
 F Z F O P K Z J S W B A L S D Y C O O K
 H I H V E K Z Q V L M N L V R N P T E Q
 N V P Q S Q K R M Z W Y M R I J J E I K
 G V J Z G J C I A X P R S C N T H W P P
 I B T U D B T L Z P F C Z M K P Q E T L
 D D E R D N U H E E R H T L K S O B C W
 E Q B A E B I S S J I G F B K T A K S K
 O Y I N P R O T H H X R P P P E W S C I
 N E A M Z B T L M G G G G A Z P V U H J
 G L M G C K A F E E Y N K C Y M M H U S
 M O U N T G I L E A D G B W Y U F P E U
 Y N P F C E N A R U R Z U J O R E T A W
 G V D E P P A L S W P S G L J T S E C E
 R Q T H Q F R Y V D Y J I M F L W V N A

DRINK
 GIDEON
 ISRAEL
 KNEES
 LAPPED

MIDIANITES
 MOUNT GILEAD
 PITCHERS
 THREE HUNDRED

TOO MANY
 TORCHES
 TRUMPETS
 WATER

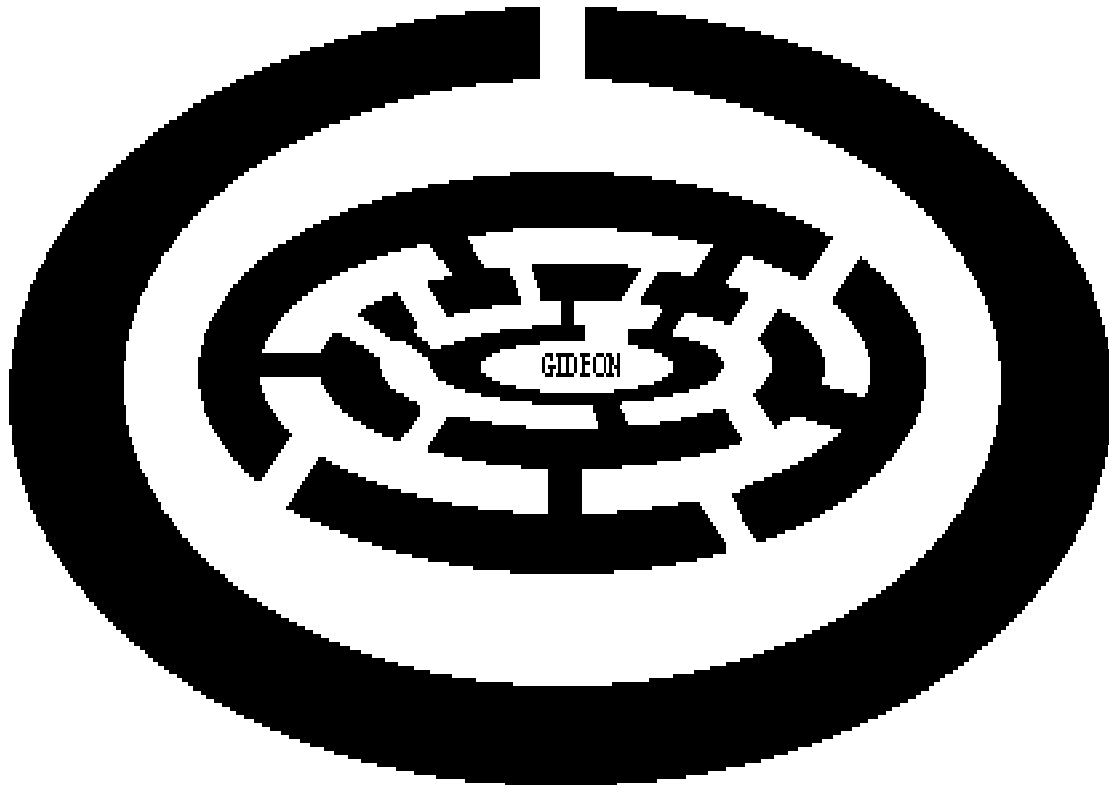

63. GIDEON'S ARMY OF 300 (JUDGES 7:1-25)

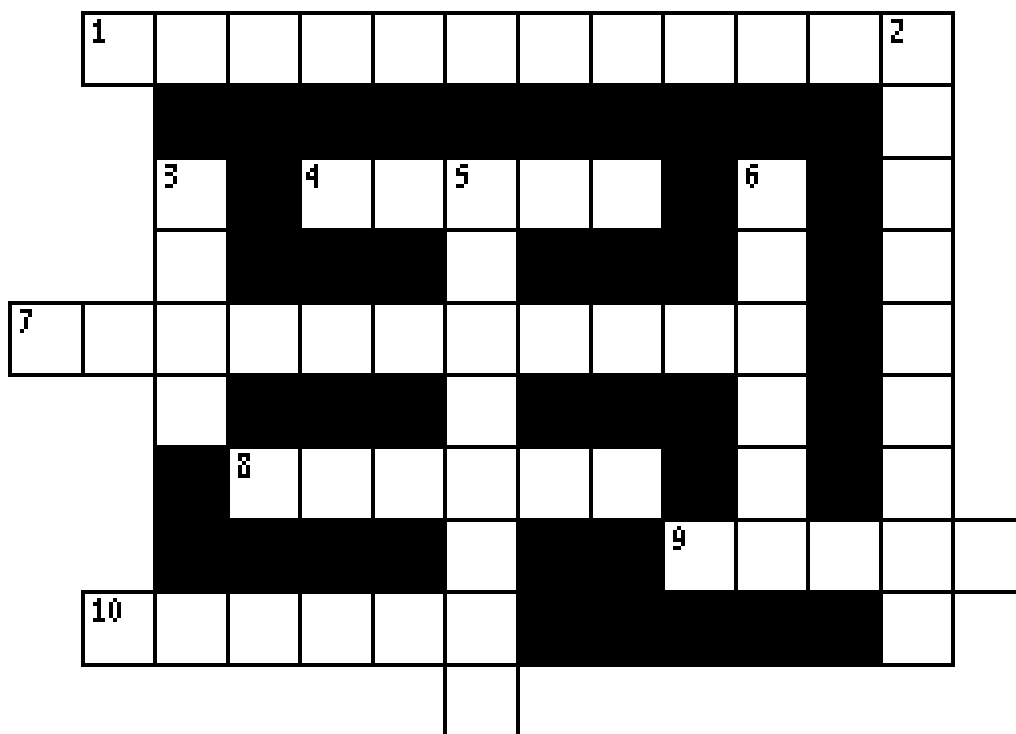

- 3 DOWN "The LORD said to Gideon, 'The people who are with you are too _____ for Me to give to the Midianites into their hands.'" **JUDGES 7:2**
- 10 ACROSS The LORD then said to Gideon, "Now therefore proclaim in the hearing of the people, saying, 'Whoever is fearful and afraid, let him turn and _____ at once from Mount Gilead.'" **JUDGES 7:3**
- 7 ACROSS "And twenty-two thousand of the people returned, and _____ _____ remained." **JUDGES 7:3**
- 6 DOWN "And the LORD said to _____, 'The people are still too many.'" **JUDGES 7:4**
- 4 ACROSS "So he brought the people down to the _____. And the LORD said to Gideon, 'Everyone who laps from the water with his tongue, as a dog laps, you shall set apart by himself.'" **JUDGES 7:5**
- 9 ACROSS "Likewise everyone who gets down on his _____ to drink." **JUDGES 7:5**
- 1 ACROSS "And the number of those who lapped, putting their hand to their mouth, was _____ _____ men; but all the rest of the people got down on their knees to drink water." **JUDGES 7:6**
- 8 ACROSS "Then the LORD said, 'By the three hundred men who _____ I will save you, and deliver the Midianites into your hand.'" **JUDGES 7:7**
- 2 DOWN "And it happened on the same night that the LORD said to him, 'Arise, go down against the camp, for I have _____ it into your hand.'" **JUDGES 7:9**
- 5 DOWN Gideon's "three companies blew the _____ and broke the pitchers- they held the torches in their left hands and the trumpets in their right hands for blowing." **JUDGES 7:20-21**

Bible Story 64

SAMSON IS BORN

JUDGES 13

64. SAMSON IS BORN

(JUDGES 13)

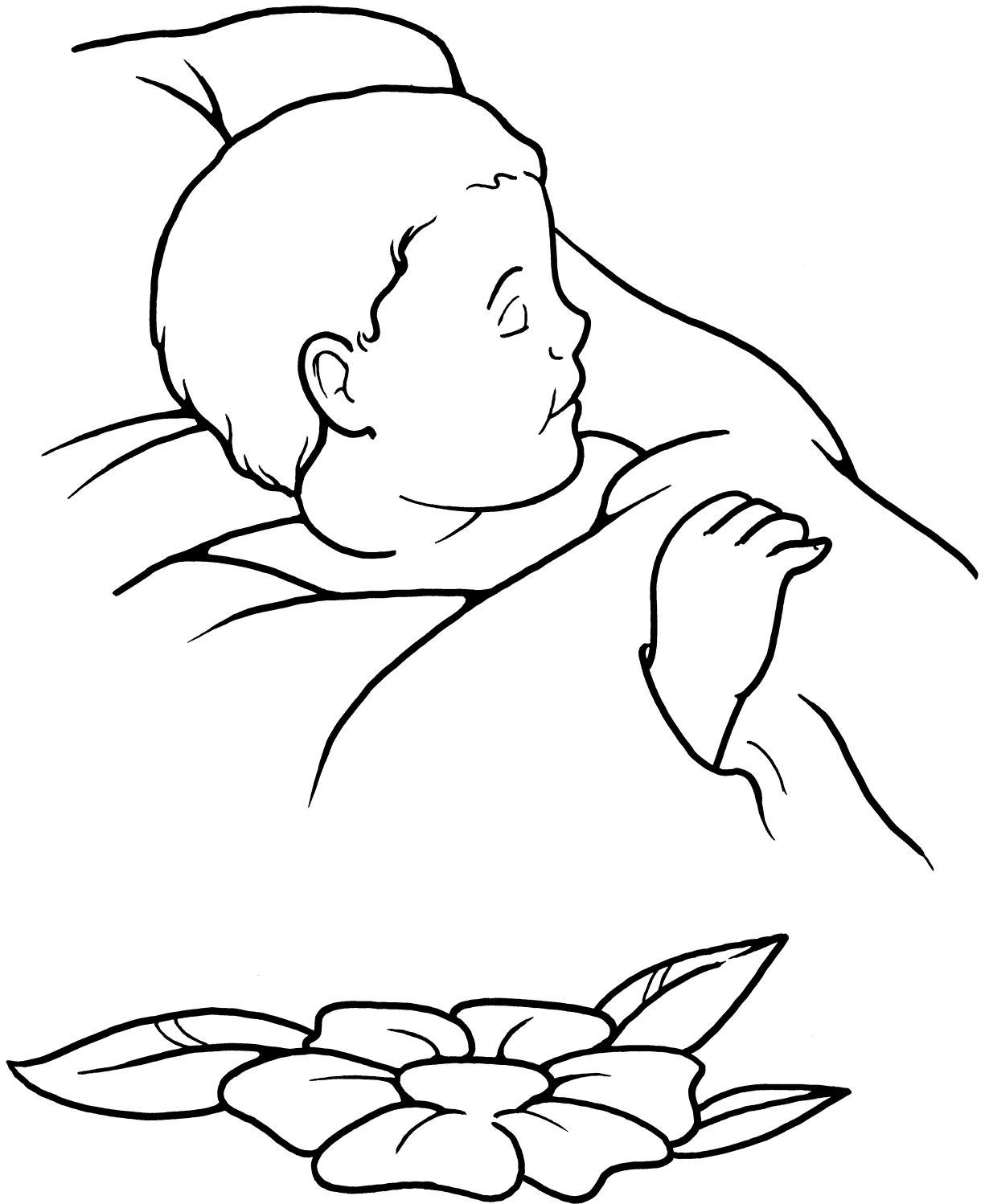

"So the woman bore a son and called his name Samson;
and the child grew, and the LORD blessed him."

JUDGES 13:24

64. SAMSON IS BORN

(JUDGES 13)

MEMORY VERSE:

"So the woman bore a son and called his name Samson; and the child grew, and the LORD blessed him." JUDGES 13:24

TRUE OR FALSE:

1. "Again the children of Israel did evil in the sight of the LORD, and the LORD delivered them into the hand of the Philistines for forty years." JUDGES 13:1

TRUE OR FALSE

CIRCLE THE CORRECT WORDS:

2. "Now there was a certain man from Zorah, of the family of the Danites, whose name was Manoah; and his wife was barren and had (**MANY, NO**) children." JUDGES 13:2
3. "And the Angel of the LORD appeared to the woman and said to her, 'Indeed now, you are barren and have borne no children, but you shall conceive and bear a (**SON, DAUGHTER**).'" JUDGES 13:3

TRUE OR FALSE:

4. He also said, "Now therefore, please be careful not to drink wine or similar drink, and not to eat any unclean thing." JUDGES 13:4

TRUE OR FALSE

CIRCLE THE CORRECT WORDS:

5. "No razor shall come upon his head, for the child is a Nazirite to (**GOD, MEN**) from the womb; and he shall begin to deliver Israel out of the hand of the Philistines." JUDGES 13:5
6. "Manoah prayed to the LORD, and said, 'O my Lord, please let the Man of God whom You sent come to us again and (**TEACH, SHOW**) us what we shall do for the child who will be born.'" JUDGES 13:8

TRUE OR FALSE:

7. "So the Angel of the LORD said to Manoah, 'Of all that I said to the woman let her be careful.'" JUDGES 13:13

TRUE OR FALSE

8. "When the Angel of the LORD appeared no more to Manoah and his wife, then Manoah knew that He was the Angel of the LORD." JUDGES 13:21

TRUE OR FALSE

FILL IN THE BLANK:

9. "So the woman bore a son and called his name _____." JUDGES 13:24

64. SAMSON IS BORN

(JUDGES 13)

U J Z I A A J P D W B J L M J
N B K Q Y Z J J W U D P M D N
C B C D Y S E H Y F R N S L O
L R T J O H L U F E R A C S S
E B E T I R I Z A N C U Z V U
A K I Q F M A G P I G O F R K
N E O R V P W E Z X R F P C O
Q F T I L S L E N I W L G M I
I D R O L E H T F O L E G N A
W J A L S N O S M A S H K L T
Z T N E R R A B W G G A B B E
K E N S V V Z U B Y N O U P N
P H I L I S T I N E S N K A R
K J R T M O J W M P G A C C O
Q Z P F H C A E T Y Z M U W B

ANGEL OF THE LORD

MANOAH

SON

BARREN

NAZIRITE

TEACH

BORN

PHILISTINES

UNCLEAN

CAREFUL

SAMSON

WINE

64. SAMSON IS BORN

(JUDGES 13)

MEMORY VERSE:

"So the woman bore a son and called his name Samson; and the child grew, and the LORD blessed him." JUDGES 13:24

TRUE OR FALSE:

1. "Again the children of Israel did evil in the sight of the LORD, and the LORD delivered them into the hand of the Philistines for forty years." JUDGES 13:1

TRUE OR FALSE

FILL IN THE BLANKS:

2. "Now there was a certain man from Zorah, of the family of the Danites, whose name was Manoah; and his wife was barren and had no _____." JUDGES 13:2
3. "And the Angel of the LORD appeared to the woman and said to her, 'Indeed now, you are barren and have borne no children, but you shall conceive and bear a _____.'" JUDGES 13:3

TRUE OR FALSE:

4. He also said, "Now therefore, please be careful not to drink wine or similar drink, and not to eat any unclean thing." JUDGES 13:4

TRUE OR FALSE

FILL IN THE BLANKS:

5. "No razor shall come upon his head, for the child is a _____ to _____ from the womb; and he shall begin to deliver Israel out of the hand of the Philistines." JUDGES 13:5
6. "Manoah prayed to the LORD, and said, 'O my Lord, please let the Man of God whom You sent come to us again and _____ us what we shall do for the child who will be born.'" JUDGES 13:8

TRUE OR FALSE:

7. "So the Angel of the LORD said to Manoah, 'Of all that I said to the woman let her be careful.'" JUDGES 13:13

TRUE OR FALSE

8. "When the Angel of the LORD appeared no more to Manoah and his wife, then Manoah knew that He was the Angel of the LORD." JUDGES 13:21

TRUE OR FALSE

FILL IN THE BLANK:

9. "So the woman bore a son and called his name _____." JUDGES 13:24

64. SAMSON IS BORN

(JUDGES 13)

P Q H K I Q W Z B U A R B S H C W O I M
M H S W L S Y E H U U R B S G C W I S U
W V S V H Q E M F P H I L I S T I N E S
N V N J A V J T V T E W P I D H Z R V P
G G R E T N T D I T N P P H C A E T U S
K S V P R P G W I R Q N Y A V R O F U E
B N N W Y R N E O D I K F G B E A Y A J
Y B G E O B A Q L D X Z O W G M K X D M
K K D B O R N B N O N B A A C Q U D D G
P K P L A N A X N A F C J N Z N N M W O
U M K V V O S I H Q E T W N H Y U B T V
Y O A D C S L T I C A L H U K M D E L S
F J S N A Q P A U U Y D C E K A L H A P
K Q P D O J U L A J Q W L N L S O T O T
T S P Z L A T B P K U K U T P O F L A W
G P R Z O I H Z M S Q I F O R V R U P B
E M X O Z C N Z T M T E E M E Y L D A H
Y B O W M T D N Q J H P R J N K Y W D J
G B S H F C R K H T T I A K C W H Q Y Y
M O L Q M J A O A A T Y C G V L X N S K

ANGEL OF THE LORD

MANOAH

SON

BARREN

NAZIRITE

TEACH

BORN

PHILISTINES

UNCLEAN

CAREFUL

SAMSON

WINE

64. SAMSON IS BORN

(JUDGES 13)

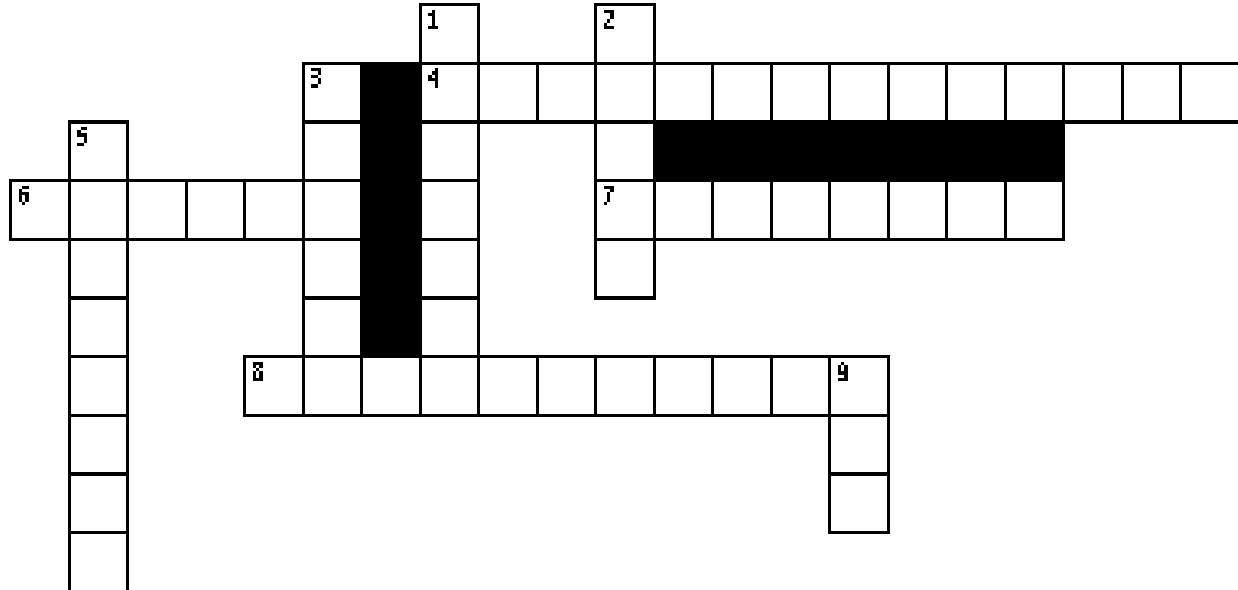

- 8 ACROSS "Again the children of Israel did evil in the sight of the LORD, and the LORD delivered them into the hand of the _____ for forty years." **JUDGES 13:1**
- 7 ACROSS "Now there was a certain man from Zorah, of the family of the Danites, whose name was Manoah; and his wife was barren and had no _____." **JUDGES 13:2**
- 9 DOWN "And the Angel of the LORD appeared to the woman and said to her, 'Indeed now, you are barren and have borne no children, but you shall conceive and bear a _____.'" **JUDGES 13:3**
- 1 DOWN He also said, "Now therefore, please be _____ not to drink wine or similar drink, and not to eat any unclean thing." **JUDGES 13:4**
- 5 DOWN "No razor shall come upon his head, for the child is a _____ to God from the womb; and he shall begin to deliver Israel out of the hand of the Philistines." **JUDGES 13:4**
- 2 DOWN "Manoah prayed to the LORD, and said, 'O my Lord, please let the Man of God whom You sent come to us again and _____ us what we shall do for the child who will be born.'" **JUDGES 13:8**
- 3 DOWN "So the Angel of the LORD said to _____, 'Of all that I said to the woman let her be careful.'" **JUDGES 13:13**
- 4 ACROSS "When the Angel of the LORD appeared no more to Manoah and his wife, then Manoah knew that He was the _____ _____ _____ _____." **JUDGES 13:21**
- 6 DOWN "So the woman bore a son and called his name _____." **JUDGES 13:24**

Bible Story 65

**SAMSON
& DELILAH**

JUDGES 16:4-21

65. SAMSON AND DELILAH

(JUDGES 16:4-21)



"And it came to pass afterward, that he loved a woman in the valley of Sorek, whose name was Delilah."
JUDGES 16:4

65. SAMSON AND DELILAH

(JUDGES 16:4-21)

MEMORY VERSE:

"No razor has ever come upon my head, for I have been a Nazirite to God from my mother's womb."
JUDGES 16:17

FILL IN THE BLANK:

1. Samson "loved a woman in the Valley of Sorek, whose name was _____." JUDGES 16:4

TRUE OR FALSE:

2. Now the lords of the Philistines said to her, "Find out where his great strength lies, and by what means may we overpower him, that we may bind him to afflict him." JUDGES 16:5
TRUE OR FALSE
3. They said to her, "Every one of us will give you eleven hundred pieces of silver." JUDGES 16:5
TRUE OR FALSE
4. But Delilah said to them, "I will not do this thing for you." JUDGES 16:6
TRUE OR FALSE

CIRCLE THE CORRECT WORDS:

5. "Samson said to her, 'If they bind me with seven fresh (**PIANO STRINGS, BOWSTRINGS**), not yet dried, then I shall become weak, and be like any other man.'" JUDGES 16:7
6. "But he broke the (**PIANO STRINGS, BOWSTRINGS**) as a strand of yarn breaks when it touches fire. So the secret of his strength was not known." JUDGES 16:9
7. Samson then said to Delilah, "If they bind me securely with new (**ROCKS, ROPES**) that have never been used, then I shall become weak, and be like any other man." JUDGES 16:11
8. But Samson "broke them off his arms like a (**THREAD, SHIRT**)." JUDGES 16:12
9. Then Samson said to her, " 'If you weave the seven locks of my (**HEAD, BEARD**) into the web of the loom'-- So she wove it tightly with the batten of the loom, and said to him, 'The Philistines are upon you, Samson!' But he awoke from his sleep, and pulled out the batten and the web from the loom." JUDGES 16:13-14
10. Then "he told her all his heart, and said to her, 'No (**HAT, RAZOR**) has ever come upon my head, for I have been a Nazirite to God from my mother's womb. If I am shaven, then my strength will leave me, and I shall become weak, and be like any other man.'" JUDGES 16:17

TRUE OR FALSE:

11. "Then she lulled him to sleep on her knees, and called for a man and had him shave off the seven locks of his head. Then she began to torment him, and his strength left him." JUDGES 16:19
TRUE OR FALSE
12. "And she said, 'The Philistines are upon you, Samson!' So he awoke from his sleep, and said, 'I will go out as before, at other times, and shake myself free!' But he did not know that the LORD had departed from him." JUDGES 16:20
TRUE OR FALSE
13. Then the Philistines let Samson go and gave him great rewards. JUDGES 16:21
TRUE OR FALSE

65. SAMSON AND DELILAH

(JUDGES 16:4-21)

B I T T A T C Y O F H H A I R
 Z U D A S R D B J U G H V Q K
 Z H D P Y G W B W T D K C N W
 N A A A H R N S A M S O N Y L
 K P Q L Q I K I S O V K C M W
 O R C M I W L P R S E P O R W
 B T D P U L H I S T B R H A Z
 H Q U A R P E T S D S E R S O
 F G J E E I I D G T E W E V A
 V H R N Q R S P I N I V O Y K
 I A K I T N H O A R E N A B U
 O U S Q N K E T N M A R E H N
 N U M N H D P Y G J G Z T S S
 S I L V E R E F W K C N O S U
 H T J N T B I R A G Z C M R D

BOWSTRINGS
 DELILAH
 GRINDER
 HAIR
 PHILISTINES

PRISON
 RAZOR
 ROPES
 SAMSON

SHAVED
 SILVER
 STRENGTH
 THREAD



65. SAMSON AND DELILAH

(JUDGES 16:4-21)

MEMORY VERSE:

"No razor has ever come upon my head, for I have been a Nazirite to God from my mother's womb."
JUDGES 16:17

FILL IN THE BLANK:

1. Samson "loved a woman in the Valley of Sorek, whose name was _____." JUDGES 16:4

TRUE OR FALSE:

2. Now the lords of the Philistines said to her, "Find out where his great strength lies, and by what means may we overpower him, that we may bind him to afflict him." JUDGES 16:5
TRUE OR FALSE
3. They said to her, "Every one of us will give you eleven hundred pieces of silver." JUDGES 16:5
TRUE OR FALSE
4. But Delilah said to them, "I will not do this thing for you." JUDGES 16:6
TRUE OR FALSE

FILL IN THE BLANKS:

5. "Samson said to her, 'If they bind me with seven fresh _____, not yet dried, then I shall become weak, and be like any other man.' " JUDGES 16:7
6. "But he broke the _____ as a strand of yarn breaks when it touches fire. So the secret of his strength was not known." JUDGES 16:9
7. Samson then said to Delilah, "If they bind me securely with new _____ that have never been used, then I shall become weak, and be like any other man." JUDGES 16:11
8. But Samson "broke them off his arms like a _____." JUDGES 16:12
9. Then Samson said to her, " 'If you weave the seven locks of my _____ into the web of the loom'-- So she wove it tightly with the batten of the loom, and said to him, 'The Philistines are upon you, Samson!' But he awoke from his sleep, and pulled out the batten and the web from the loom." JUDGES 16:13-14
10. Then "he told her all his heart, and said to her, 'No _____ has ever come upon my head, for I have been a Nazirite to God from my mother's womb. If I am shaven, then my strength will leave me, and I shall become weak, and be like any other man.'" JUDGES 16:17

TRUE OR FALSE:

11. "Then she lulled him to sleep on her knees, and called for a man and had him shave off the seven locks of his head. Then she began to torment him, and his strength left him." JUDGES 16:19
TRUE OR FALSE
12. "And she said, 'The Philistines are upon you, Samson!' So he awoke from his sleep, and said, 'I will go out as before, at other times, and shake myself free!' But he did not know that the LORD had departed from him." JUDGES 16:20
TRUE OR FALSE
13. Then the Philistines let Samson go and gave him great rewards. JUDGES 16:21
TRUE OR FALSE

65. SAMSON AND DELILAH

(JUDGES 16:4-21)

I X W L T B I D X R G W L U W B G J S T
 O Y G O L D F G Y A R N K H J V X C H J
 X L F U M V B P C Y Y D I I V B W R P L
 K N Z P E N L C X R Q K Q P H W E X W J
 E D A W Z P A R E D N I R G Y A D V J T
 Y N O S M A S V P E D B S K D Y I D H B
 T C N C I S E U R P O A P R G U C I N V
 E V S R I Y E I E W O R S E M K P M F Q
 Z O H E D G Z N S V I G O N T Y S O G O
 Q S U V Z N C T I S O S E A U T L O I V
 V K S L P W R P O T K A Z I R H R F E Y
 L L Y I Z I L N M T S U P E V F O U G X
 S S J S N R W N H O P I N P E Q Z D W C
 R D H G V Y I S Y J Z G L Q Z L A I K J
 S F S A U Z C A Y Q T K E I U H R V O N
 B A N P V U A C H H S S U F H M O E I R
 B B D R D E H A L I L E D R U P P M L O
 Z R Y F W G D N M L T Y V C I G D N D P
 F N I M E F Z P B P V P F G X Q Q B S E
 W E B E E Y S C P V G F I O Q W J A U S

BOWSTRINGS
 DELILAH
 GRINDER
 HAIR
 PHILISTINES

PRISON
 RAZOR
 ROPES
 SAMSON
 SHAVED

SILVER
 STRENGTH
 THREAD
 YARN



65. SAMSON AND DELILAH

(JUDGES 16:4-21)

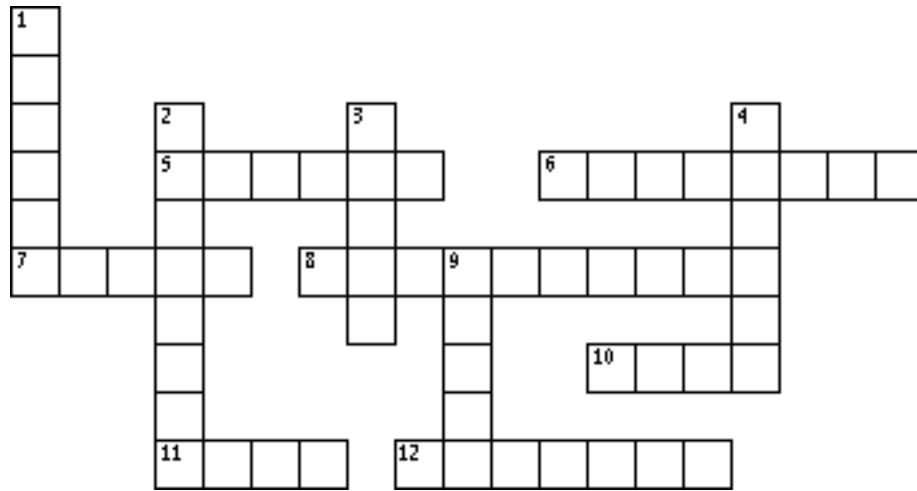

- 12 ACROSS Samson "loved a woman in the Valley of Sorek, whose name was ____." **JUDGES 16:4**
- 2 DOWN Now the lords of the Philistines said to her, "Find out where his great ____ lies, and by what means may we overpower him, that we may bind him to afflict him." **JUDGES 16:5**
- 1 DOWN They said to her, "Every one of us will give you eleven hundred pieces of ____." **JUDGES 16:5**
- 8 ACROSS "Samson said to her, 'If they bind me with seven fresh ____, not yet dried, then I shall become weak, and be like any other man.'" **JUDGES 16:7**
- 10 ACROSS "But he broke the bowstrings as a strand of ____ breaks when it touches fire. So the secret of his strength was not known." **JUDGES 16:9**
- 7 ACROSS Samson then said to Delilah, "If they bind me securely with new ____ that have never been used, then I shall become weak, and be like any other man." **JUDGES 16:11**
- 5 ACROSS But Samson "broke them off his arms like a ____." **JUDGES 16:12**
- 11 ACROSS Samson said to her, "If you weave the seven locks of my ____ into the web of the loom-" **JUDGES 16:13**
- 3 DOWN "He told her all his heart, and said to her, 'No ____ has ever come upon my head.'" **JUDGES 16:17**
- 9 DOWN "Then she lulled him to sleep on her knees, and called for a man and had him ____ off the seven locks of his head." **JUDGES 16:19**
- 6 ACROSS "He did not know that the LORD had ____ from him." **JUDGES 16:20**
- 4 DOWN "They bound him with bronze fetters, and he became a grinder in the ____." **JUDGES 16:21**

Bible Story 66

**SAMSON PULLS
DOWN A TEMPLE**

JUDGES 16:22-31

66. SAMSON PULLS DOWN A TEMPLE

(JUDGES 16:22-31)



"Then Samson called to the LORD, saying, 'O Lord GOD, remember me, I pray!' "

JUDGES 16:28

66. SAMSON PULLS DOWN A TEMPLE

(JUDGES 16:22-31)

MEMORY VERSE:

"Then Samson called to the LORD, saying, 'O Lord GOD, remember me, I pray!
JUDGES 16:28

TRUE OR FALSE:

1. Now the hair of Samson's head "began to grow again after it had been shaven." **JUDGES 16:22**
TRUE OR FALSE
2. "Now the lords of the Philistines gathered together to offer a great sacrifice to Dagon their god, and to rejoice." **JUDGES 16:23**
TRUE OR FALSE
3. So it happened, when their hearts were merry, that they said, "Call for Samson, that he may perform for us." So they called for Samson from the prison, but he would not perform for them.
JUDGES 16:25
TRUE OR FALSE

CIRCLE THE CORRECT WORDS:

4. "They stationed him between two (**PILLARS, PEOPLE**)." **JUDGES 16:25**
5. "Then Samson said to the lad who held him by the hand, 'Let me feel the pillars which support the (**TABLE, TEMPLE**), so that I can lean on them.' " **JUDGES 16:26**
6. "There were about three (**HUNDRED, THOUSAND**) men and women on the roof who watched while Samson performed." **JUDGES 16:27**

FILL IN THE BLANK:

7. "Then Samson called to the LORD, saying, 'O Lord GOD, remember me, I pray!
_____ me, I pray, just this once, O God, that I might with one blow take vengeance on the Philistines for my two eyes!' " **JUDGES 16:28**

TRUE OR FALSE:

8. "And Samson took hold of the two middle pillars which supported the temple, and he braced himself against them, one on his right and the other on his left." **JUDGES 16:29**
TRUE OR FALSE
9. Samson "pushed with all his might, and the temple fell on the lords and all the people who were in it. So the dead that he killed at his death were more _____ than he killed in his life."
JUDGES 16:30
TRUE OR FALSE

66. SAMSON PULLS DOWN A TEMPLE

(JUDGES 16:22-31)

P X W E I J Y M V X W I B O P
E P Z F O Q Y A O P Y X D F G
R E K J T R O Z J J P G R S K
F S K T A I N O S I R P C R B
O G E C I F I R C A S Y G A U
R D Q E N L F S J F Z P R L K
M E J J R S V H E H E Y G L C
N P B Z P T L M A G W L N I U
M S E N I T S I L I H P L P M
G Z B Z I N O S M A S N G L D
F C E L P M E T W E B E Z L L
H C R K Q F S M L U M V J M Y
S T R E N G T H E N W A P S A
A Q B C D A V S Z W U H N Z R
W I K T N O G A D D F S U F P

DAGON

PILLARS

SAMSON

FELL

PRAY

SHAVEN

PERFORM

PRISON

STRENGTHEN

PHILISTINES

SACRIFICE

TEMPLE

66. SAMSON PULLS DOWN A TEMPLE

(JUDGES 16:22-31)

MEMORY VERSE:

"Then Samson called to the LORD, saying, 'O Lord GOD, remember me, I pray!
JUDGES 16:28

TRUE OR FALSE:

1. Now the hair of Samson's head "began to grow again after it had been shaven." **JUDGES 16:22**
TRUE OR FALSE
2. "Now the lords of the Philistines gathered together to offer a great sacrifice to Dagon their god, and to rejoice." **JUDGES 16:23**
TRUE OR FALSE

CIRCLE THE CORRECT WORDS:

3. "So it happened, when their hearts were merry, that they said, 'Call for Samson, that he may perform for us.' So they called for Samson from the (**PALACE**, **PRISON**), and he performed for them." **JUDGES 16:25**
4. "They stationed him between two (**PILLARS**, **PEOPLE**)." **JUDGES 16:25**

FILL IN THE BLANKS:

5. "Then Samson said to the lad who held him by the hand, 'Let me feel the pillars which support the _____, so that I can lean on them.'" **JUDGES 16:26**
6. "There were about _____ men and women on the roof who watched while Samson performed." **JUDGES 16:27**
7. "Then Samson called to the LORD, saying, 'O Lord GOD, remember me, I pray! _____ me, I pray, just this once, O God, that I might with one blow take vengeance on the Philistines for my two eyes!' " **JUDGES 16:28**

TRUE OR FALSE:

8. "And Samson took hold of the two middle pillars which supported the temple, and he braced himself against them, one on his right and the other on his left." **JUDGES 16:29**
TRUE OR FALSE
9. Samson "pushed with all his might, and the temple fell on the lords and all the people who were in it. So the dead that he killed at his death were more than he killed in his life." **JUDGES 16:30**
TRUE OR FALSE

66. SAMSON PULLS DOWN A TEMPLE

(JUDGES 16:22-31)

H X D H P G F U V L B S L F L O D O V P
G B T S Z T Z D D N P Y Y H L Y O T G E
B Y N E P E B F M P U D L L A K T H R I
A K Y Q Q L C H N Z U Y H D G E C K K P
X Y B M L S S G S S R B X M R O F R E P
H T P B A V L S H N J O K I H O U W S L
P P B B L P S U E N E J K P G J V A Z E
T S N C L Z N Q E N Z V X M N S C W L P
Q J L B M S P H P V I C A W W R N L M K
X V N B S M T J S M F T D H I Z V L I S
O D Z Y O G M R P T J V S F S N M R V N
N T H U N B A V E O N G I I B N U Q V U
C T R E A L N M R O F C O L L W O N T W
M Q R W L A P Q S N E W F G W I O G L S
B T A I L L Q M B G E H M S B S H C A C
S F P D E K A D N I O H Q Z I I O P C D
I N A O K S Q D G C R B R R V O X R M T
F F J K N I H F E L L X P R B V M H G P
A T Y J M Y V D B N I B K O H M G N K M
W H G Q G T Z V L E Y U D J C G Q N M S

DAGON

PILLARS

SAMSON

FELL

PRAY

SHAVEN

PERFORM

PRISON

STRENGTHEN

PHILISTINES

SACRIFICE

TEMPLE

66. SAMSON PULLS DOWN A TEMPLE

(JUDGES 16:22-31)

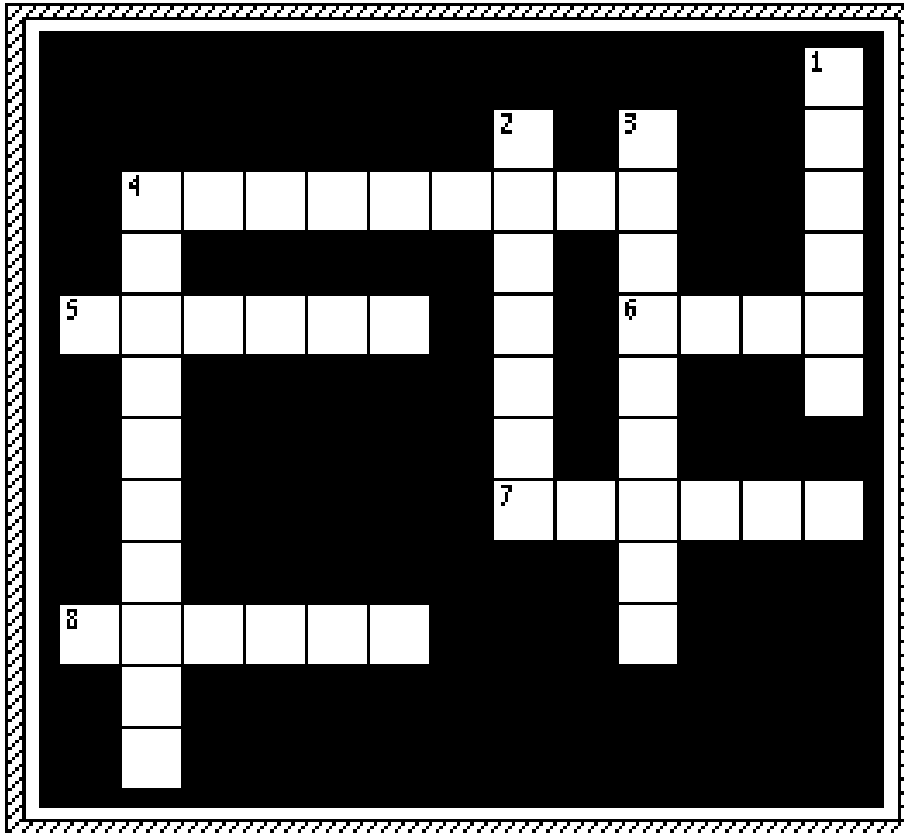

- 8 ACROSS Now the hair of Samson's head "began to grow again after it had been ____."
JUDGES 16:22
- 4 ACROSS "Now the lords of the Philistines gathered together to offer a great ____ to Dagon their god, and to rejoice." **JUDGES 16:23**
- 5 ACROSS "They called for Samson from the ____, and he performed for them." **JUDGES 16:25**
- 2 DOWN "They stationed him between two ____." **JUDGES 16:25**
- 1 DOWN "Then Samson said to the lad who held him by the hand, 'Let me feel the pillars which support the ____, so that I can lean on them.'" **JUDGES 16:26**
- 3 DOWN "There were about three thousand men and women on the roof who watched while Samson ____." **JUDGES 16:27**
- 4 DOWN "Then Samson called to the LORD, saying, 'O Lord GOD, remember me, I pray! ____ me, I pray, just this once, O God, that I might with one blow take vengeance on the Philistines for my two eyes!' " **JUDGES 16:28**
- 7 ACROSS "And ____ took hold of the two middle pillars which supported the temple, and he braced himself against them, one on his right and the other on his left." **JUDGES 16:29**
- 6 ACROSS Samson "pushed with all his might, and the temple ____ on the lords and all the people who were in it. So the dead that he killed at his death were more than he killed in his life." **JUDGES 16:30**

Bible Story 67

**RUTH CHOOSES TO
STAY WITH NAOMI**

RUTH 1:1-18

67. RUTH CHOOSES TO STAY WITH NAOMI

(RUTH 1:1-18)



"Ruth said: 'Entreat me not to leave you, or turn back from following after you; for wherever you go, I will go; and wherever you lodge, I will lodge; your people shall be my people, and your God, my God.' "

RUTH 1:16

67. RUTH CHOOSES TO STAY WITH NAOMI

(RUTH 1:1-18)

MEMORY VERSE:

"Ruth said: 'Entreat me not to leave you, or turn back from following after you; for wherever you go, I will go; and wherever you lodge, I will lodge; your people shall be my people, and your God, my God.' " RUTH 1:16

TRUE OR FALSE:

1. "A certain man of Bethlehem, Judah, went to sojourn in the country of Moab, he and his wife and his two sons." RUTH 1:1

TRUE OR FALSE

2. "Then Elimelech, Naomi's husband died; and she was left, and her two sons." RUTH 1:3

TRUE OR FALSE

CIRCLE THE CORRECT WORDS:

3. "Now they took wives of the women of Moab: the name of the one was Orpah, and the name of the other Ruth. And they dwelt there about (TWO, TEN) years." RUTH 1:4

4. "Then both Mahlon and Chilion also (DIED, LIVED); so the woman survived her two sons and her husband." RUTH 1:5

5. "Then she arose with her daughters-in-law that she might return from the country of Moab, for she had heard in the country of Moab that the LORD had visited His people in giving them (BREAD, BEARDS)." RUTH 1:6

TRUE OR FALSE:

6. Naomi said, "Come with me my daughters, for it is good that you will go with me." RUTH 1:11

TRUE OR FALSE

7. "Ruth said: 'Entreat me not to leave you, or turn back from following after you; for wherever you go, I will go; and wherever you lodge, I will lodge; your people shall be my people, and your God, my God.' " RUTH 1:16

TRUE OR FALSE

67. RUTH CHOOSES TO STAY WITH NAOMI

(RUTH 1:1-18)

A N R U T E R M V H W G D U B
 W P Q J T I S S O M B H T U R
 B Z J B A O M V J E A Y R O U
 P D I E D Q T M J G N H C F B
 E C R E V E R E H W M I L L W
 S C B T I D F A E E O P M O U
 N Q B E O J A Z A U R Y G A N
 A I R J T Q Y S W S P B R L F
 O M E H E L H T E B A N G M M
 M W B Z A R Y V L W H O N S D
 I Z K Z N I I H Z D W I G Z L
 G K E K R W O M X W U L Z F S
 E L I M E L E C H Y F I J P V
 D K F C P L F L P P I H P G R
 E D A E R B V S J Z X C N K C

BETHLEHEM
 BREAD
 CHILION
 DIED
 ELIMELECH

FAMINE
 MAHLON
 MOAB
 NAOMI
 ORPAH

RETURN
 RUTH
 WHEREVER
 WIVES

WRITE DOWN THE LETTERS AS YOU COME TO THEM ON THE LINES BELOW

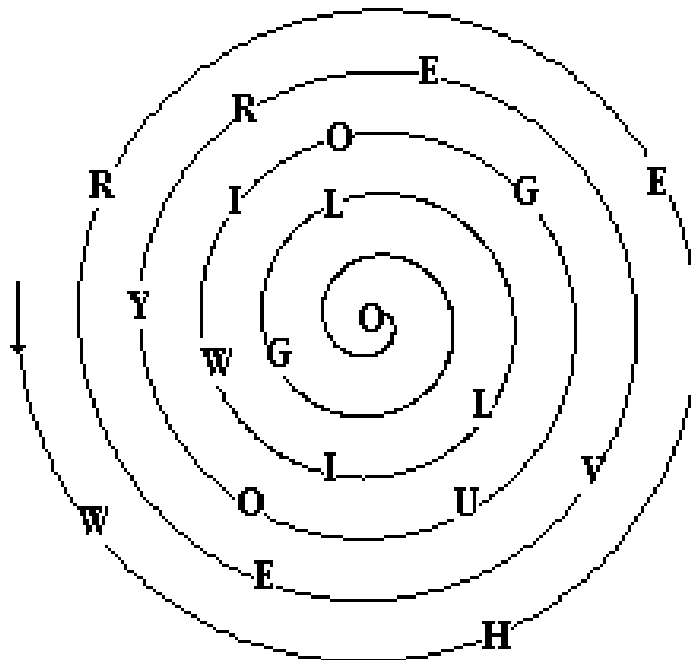

67. RUTH CHOOSES TO STAY WITH NAOMI

(RUTH 1:1-18)

MEMORY VERSE:

"Ruth said: 'Entreat me not to leave you, or turn back from following after you; for wherever you go, I will go; and wherever you lodge, I will lodge; your people shall be my people, and your God, my God.' " RUTH 1:16

TRUE OR FALSE:

1. "A certain man of Bethlehem, Judah, went to sojourn in the country of Moab, he and his wife and his two sons." **RUTH 1:1**

TRUE OR FALSE

2. "Then Elimelech, Naomi's husband died; and she was left, and her two sons." **RUTH 1:3**

TRUE OR FALSE

FILL IN THE BLANKS:

3. "Now they took wives of the women of Moab: the name of the one was _____, and the name of the other _____. And they dwelt there about _____ years." **RUTH 1:4**

4. "Then both Mahlon and Chilion also _____; so the woman _____ survived her two sons and her husband." **RUTH 1:5**

5. "Then she arose with her daughters-in-law that she might _____ from the country of Moab, for she had heard in the country of Moab that the LORD had visited His people in giving them _____." **RUTH 1:6**

TRUE OR FALSE:

6. Naomi said, "Come with me my daughters, for it is good that you will go with me." **RUTH 1:11**

TRUE OR FALSE

FILL IN THE BLANKS:

7. "Ruth said: 'Entreat me not to leave you, or turn back from following after you; for _____ you go, I will go; and _____ you lodge, I will lodge; _____ people shall be _____ people, and _____ God, _____ God.' " **RUTH 1:16**

67. RUTH CHOOSES TO STAY WITH NAOMI

(RUTH 1:1-18)

C S P D B G Q V C K Y X X S W N S A K N K S V X V
 B T W Y Y X N Q Q C O P G Z J J W R D R M O A B X
 H O Q H N G R Z I T F J Y F M M U L D Y D M Z G O
 P T T U M R U U W I V H P P K E A W O Y B C K E U
 D W A Q H Q T A Z O M G Y G O T N H K D K Z F I V
 E F U S L I E N K T S E B K I P D I L B R E A D Z
 B D U S D P R M K A V U D B T L S J M O K L B V A
 C A I N O I L I H C M W R U E J J U Q A N U S L U
 P M H E R H F G Q N A D C K J C H O K H F T M P E
 O F E I D Z H F J R Z W G C K V Q E L J T M O P F
 G H R L E I P H B P S Y R U K T H A P R O U A U P
 U K J S U V J A B I H P W M P W O P W I A O R Z T
 P N S J W V T W R Q M Z G H Z H E T K P T E T V O
 M C T F J B B X B D X W N D E P W C I T W M M F N
 N U M E H E L H T E B B G L Y R E S J V L X Z R I
 R Q A F N Q I P K J S M Z S Y J E C S R A N J K J
 X D Z O S Y A E E Q V W J V O H B V U F P O S K J
 D C S P Z E M S F R O U P R J Q K H E E P B M Y Y
 C N D E K L M G J I J F N C F O S U E R A U X R T
 U W J O B N T D T L J I U M A I M O A N Y L P G H
 E L I M E L E C H S E W O L H A U E A J X O C I G
 G T Q O Z V Y E E T A I F B A W H C V O V P U K F
 D I I C F Q L P J F W V L L H V P N D U Q M D G Y
 T W K F H T I Z Z A L E L A Z M E Q Q G D C T U O
 A P T K N A O C Z Y Z S M C Y F V L E F V C X A Q

BETHLEHEM
 BREAD
 CHILION
 DIED
 ELIMELECH

FAMINE
 MAHLON
 MOAB
 NAOMI
 WHEREVER YOU GO

RETURN
 RUTH
 ORPAH
 WIVES

WRITE DOWN THE LETTERS AS YOU COME TO THEM ON THE LINES BELOW

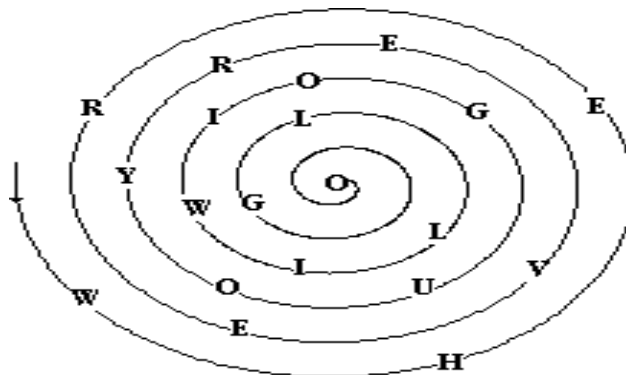

67. RUTH CHOOSES TO STAY WITH NAOMI

(RUTH 1:1-18)

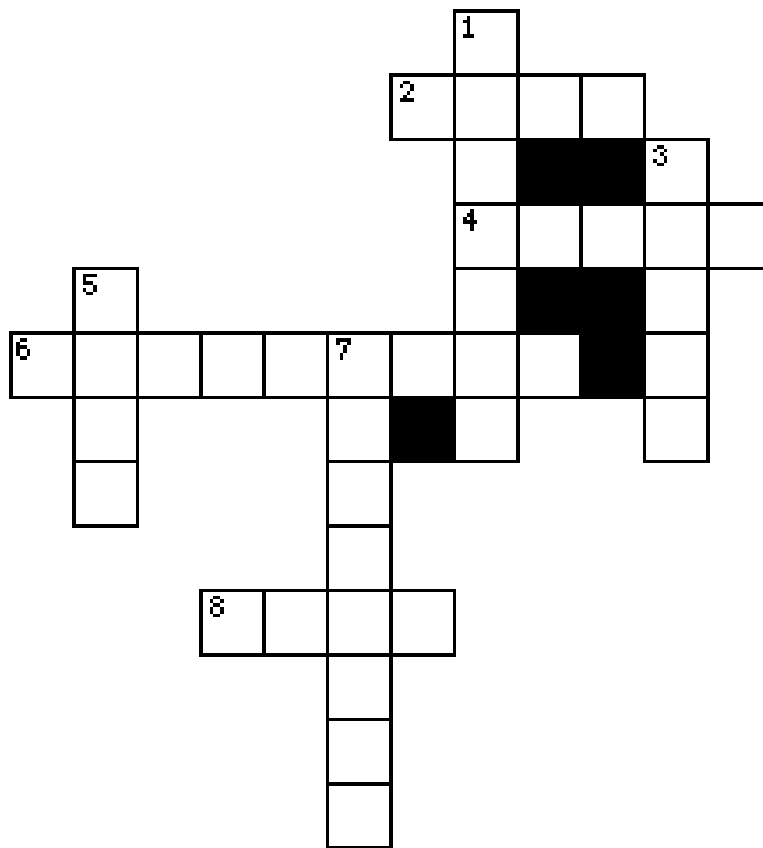

- 7 DOWN "Ruth said: 'Entreat me not to leave you, or turn back from following after you; for _____ you go, I will go; and wherever you lodge, I will lodge; your people shall be my people, and your God, my God.'" **RUTH 1:16**
- 5 DOWN "A certain man of Bethlehem, Judah, went to sojourn in the country of _____, he and his wife and his two sons." **RUTH 1:1**
- 1 DOWN "Then Elimelech, Naomi's _____died; and she was left, and her two sons." **RUTH 1:3**
- 2 ACROSS "Now they took wives of the women of Moab: the name of the one was Orpah, and the name of the other _____. And they dwelt there about ten years." **RUTH 1:4**
- 8 ACROSS "Then both Mahlon and Chilion also _____; so the woman survived her two sons and her husband." **RUTH 1:5**
- 4 ACROSS "Then she arose with her daughters-in-law that she might return from the country of Moab, for she had heard in the country of Moab that the LORD had visited His people in giving them _____." **RUTH 1:6**
- 3 DOWN "But _____ said, 'Turn back my daughters; why will you go with me?' " **RUTH 1:11**
- 6 ACROSS "Ruth said: 'Entreat me not to leave you, or turn back from _____ after you; for wherever you go, I will go; and wherever you lodge, I will lodge; your people shall be my people, and your God, my God.'" **RUTH 1:16**

Bible Story 68

RUTH GLEANS IN THE FIELDS

RUTH 2

68. RUTH GLEANS IN THE FIELD (RUTH 2)



"And Ruth the Moabitess said unto Naomi, Let me now go to the field, and glean ears of corn after *him* in whose sight I shall find grace. And she said unto her, Go, my daughter."

RUTH 2:2

68. RUTH GLEANS IN THE FIELD

(RUTH 2)

MEMORY VERSE:

"The LORD repay your work, and a full reward be given you by the LORD God of Israel, under whose wings you have come for refuge." RUTH 2:12

CIRCLE THE CORRECT WORDS:

1. Ruth "went and (**CLEANED, GLEANED**) in the field after the (**SWEEPERS, REAPERS**). And she happened to come to the part of the field belonging to Boaz, who was of the family of Elimelech." **RUTH 2:3**
2. "Boaz said to Ruth, 'You will listen, my daughter, will you not? Do not glean in another field, nor go from here, but stay (**CLOSE BY, FAR FROM**) my young women." **RUTH 2:8**
3. Ruth "gleaned in the (**TEMPLE, FIELD, YARD**) until evening, and beat out what she had gleaned, and it was about an ephah of (**CORN, BARLEY**)." **RUTH 2:17**

UNDERLINE THE CORRECT ANSWER:

4. "And her mother-in-law said to her,..." **RUTH 2:19**
 - a. Where have you gleaned today?
 - b. And where did you work?
 - c. Blessed be the one who took notice of you.
 - d. All of the above

TRUE OR FALSE:

5. "So she told her mother-in-law with whom she had worked, and said, 'The man's name with whom I worked today is Boaz.' " **RUTH 2:19**

TRUE OR FALSE
6. "Then Naomi said to her daughter-in-law, 'Blessed be he of the LORD, who has not forsaken His kindness to the living and the dead!' And Naomi said to her, 'The man is a relative of ours, one of our near kinsmen.' " **RUTH 2:20**

TRUE OR FALSE

FILL IN THE BLANK:

7. "So she stayed close by the young women of _____, to glean until the end of the barley harvest and wheat harvest; and she dwelt with her mother-in-law." **RUTH 2:23**

68. RUTH GLEANS IN THE FIELD

(RUTH 2)

K R K Z H F H F H U U N O V Y
I C O Y I J Q S Q H O Q K D R
N M I E Z C O W O P E L Q D O
S L L Y Y V S E V A E H S E V
M D T S E V R A H E P K K N A
A B T O N T A U E W T D L A F
N X E J J W B O A Z H D W E D
C A J F T H W D W V C E K L J
U W A L N I R E H T O M A G I
M C K A P I M O A N S Y I T P
D W D R A W E R E A C E J Q E
L R U T H P V S B R H L S E P
R E L A T I V E K L U R U N H
S J K H L J M J S W E A E R A
V U P A N E M O W J C B A Y H

BARLEY
BOAZ
EPHAH
FAVOR

FIELD
GLEANED
HARVEST
KINSMAN

MOTHER-IN-LAW
NAOMI
RELATIVE
REWARD

RUTH
SHEAVES
WHEAT
WOMEN



68. RUTH GLEANS IN THE FIELD

(RUTH 2)

MEMORY VERSE:

"The LORD repay your work, and a full reward be given you by the LORD God of Israel, under whose wings you have come for refuge." RUTH 2:12

FILL IN THE BLANKS:

1. Ruth "went and _____ in the field after the _____. And she happened to come to the part of the field belonging to Boaz, who was of the family of Elimelech." **RUTH 2:3**
2. "Boaz said to Ruth, 'You will listen, my daughter, will you not? Do not glean in another field, nor go from here, but stay _____ my young women.'" **RUTH 2:8**
3. Ruth "gleaned in the _____ until evening, and beat out what she had gleaned, and it was about an ephah of _____." **RUTH 2:17**

UNDERLINE THE CORRECT ANSWER:

4. "And her mother-in-law said to her,..." **RUTH 2:19**
 - a. Where have you gleaned today?
 - b. And where did you work?
 - c. Blessed be the one who took notice of you.
 - d. All of the above

TRUE OR FALSE:

5. "So she told her mother-in-law with whom she had worked, and said, 'The man's name with whom I worked today is Boaz.'" **RUTH 2:19**

TRUE OR FALSE

FILL IN THE BLANK:

6. "Then Naomi said to her daughter-in-law, '_____ be he of the LORD, who has not forsaken His _____ to the living and the dead!' And Naomi said to her, 'The man is a relative of ours, one of our near kinsmen.'" **RUTH 2:20**
7. "So she stayed close by the young women of _____, to glean until the end of the barley harvest and wheat harvest; and she dwelt with her mother-in-law." **RUTH 2:23**

68. RUTH GLEANS IN THE FIELD

(RUTH 2)

P S P Q Q A F U N I U C W Y D O H I H S V X Z U T
M N P I J Z V T A E T V Z X W V J B X Q U I B U T
W B R L I E I T D P O C O D T S D R V U B Z T C C
N K X H C M O D F E M K I N S M A N S M N F P Q M
G K R T T M O I Y I N C A F L P U W U J H Z Z N P
K O O O C D E T Q Y J A K B A T O I M O A N F R M
B J S Y V L N D H B K H E E O W L G S E V A E H S
Y Q L O D A H Q U E G R U L A B O T H Q N N V U L
K S K A J W F C Q B R E N H G H R K H L A D F K C
P P W V W Q I U T P H I U T P J E W U T U H H B S
U M V C B O A Z H P D M N L A Y L I Q S V L N I G
Y B J A Y H U J T Y G R D L D K A U T E A U E F E
F B R L J I H K T F D Q A U A P T M P V E Y E W Y
K O E O T T T S R O V N L W Y W I F L R I E M L U
T H W P N A U Y R J B Y U W E G V O J A S E J J W
G S E Z H L R M O W G M F Q S R E E B H G J Q B I
E S L M A A A J W U C A L N M K U P J J J A V B A
Y R V F S B H T P S N S Y I U G Y K H T P V E K C
G V D M L Z F A N S Z G H S M P E J T W Z K V J L
M N D Q P Z F A K I H V W V S S L F J P F M V K P
Q G Z S U N T U B A K Y X O E O R Y Y M B O L U A
H D Z Q T K Q E C G K K O U M T A T R L N Z A M I
V P O V N O H N D W R W I U J E B W D U K L I R E
V K W P D B A Q W A E L R A M W N U C G M A L Y Y
G S H B R H U N P F N W F D G I I G G C Z M R R A

BARLEY
BOAZ
EPHAH
FAVOR

FIELD
GLEANED
HARVEST
KINSMAN

MOTHER-IN-LAW
NAOMI
RELATIVE
REWARD

RUTH
SHEAVES
YOUNG WOMEN



68. RUTH GLEANS IN THE FIELD

(RUTH 2)

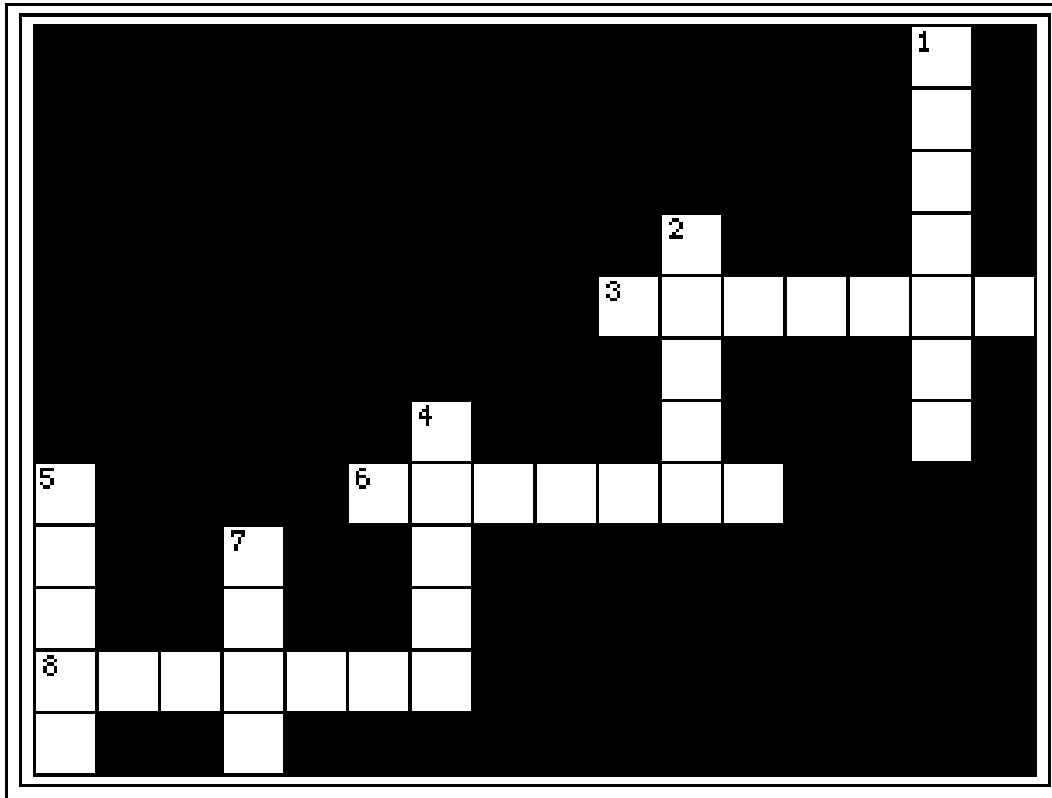

- 5 DOWN "The LORD repay your work, and a full reward be given you by the LORD God of Israel, under whose _____ you have come for refuge." **RUTH 2:12**
- 8 ACROSS Ruth "went and _____ in the field after the reapers. And she happened to come to the part of the field belonging to Boaz, who was of the family of Elimelech." **RUTH 2:3**
- 2 DOWN "Boaz said to Ruth, 'You will listen, my daughter, will you not? Do not glean in another field, nor go from here, but stay _____ by my young women.'" **RUTH 2:8**
- 4 DOWN Ruth "gleaned in the _____ until evening, and beat out what she had gleaned, and it was about an ephah of barley." **RUTH 2:17**
- 3 ACROSS "And her mother-in-law said to her, 'Where have you gleaned today? And where did you work? _____ be the one who took notice of you.'" **RUTH 2:19**
- 7 DOWN "So she told her mother-in-law with whom she had worked, and said, 'The man's name with whom I worked today is _____.'" **RUTH 2:19**
- 6 ACROSS "Then Naomi said to her daughter-in-law, 'Blessed be he of the LORD, who has not forsaken His kindness to the living and the dead!' And Naomi said to her, 'The man is a relative of ours, one of our near _____.'" **RUTH 2:20**
- 1 DOWN "So she stayed close by the young women of Boaz, to glean until the end of the barley _____ and wheat harvest; and she dwelt with her mother-in-law." **RUTH 2:23**

Bible Story 69

**BOAZ
REDEEMS RUTH**

RUTH 4:1-13

69. BOAZ REDEEMS RUTH

(RUTH 4:1-13)



"Moreover Ruth the Moabitess, the wife of Mahlon, have I purchased to be my wife, to raise up the name of the dead upon his inheritance, that the name of the dead be not cut off from among his brethren, and from the gate of his place: ye *are* witnesses this day."

RUTH 4:10

69. BOAZ REDEEMS RUTH

(RUTH 4:1-13)

MEMORY VERSE:

"As for our Redeemer, the LORD of hosts is His name, the Holy One of Israel." ISAIAH 47:4

FILL IN THE BLANKS:

1. Now Boaz "took ten men of the elders of the city, and said, 'Sit down here.' So they sat down. Then he said to the near _____, 'Naomi, who has come back from the country of Moab, _____ the piece of land which belonged to our brother Elimelech.'" **RUTH 4:2-3**

TRUE OR FALSE:

2. "Boaz said, 'On the day you buy the field from the hand of Naomi, you must also buy it from Ruth the Moabitess, the wife of the dead, to raise up the name of the dead on his inheritance.'" **RUTH 4:5**

TRUE OR FALSE

CIRCLE THE CORRECT WORDS:

3. "And the near kinsman said, 'I (**CAN, CANNOT**) redeem it for myself, lest I ruin my own inheritance. You redeem my right of redemption for yourself, for I (**CAN, CANNOT**) redeem it.'" **RUTH 4:6**
4. "Now this was the custom in former times in Israel concerning redeeming and exchanging, to confirm anything: one man took off his (**SANDAL, COAT**) and gave it to the other." **RUTH 4:7**

FILL IN THE BLANK:

5. "Therefore the near kinsman said to Boaz, 'Buy it for yourself.' So he took off his _____." **RUTH 4:8**

TRUE OR FALSE:

6. "So Boaz took Ruth and she became his wife." **RUTH 4:13**
TRUE OR FALSE
7. "Then the women said to Naomi, 'Blessed be the LORD, who has not left you this day without a near kinsman; and may his name be famous in Israel.'" **RUTH 4:14**
TRUE OR FALSE

69. BOAZ REDEEMS RUTH

(RUTH 4:1-13)

K J O O M P J L E B V F D A H
 S X W Z M C K I N S M A N U T
 P I A I U E W P M Z I T Q E T
 P O M S N B E U D Z D N A L R
 B W T O F H Y D W N O Q C N R
 R O H A A Q E T E K N H U Q W
 M E R U I N L R Q R H A J X P
 L L Q V M J J A I E I U K N N
 O E I C B I T N D T T U S A K
 S V L A Q R N D X N A A M Y B
 L D L D N C O R I O A N G Q C
 K D H L E A A T T B U S C M D
 W Z T O S R M A H H A T J E W
 R U T H Q T S E A E F T T Q K
 V Z Y Z V C S Z L F R D A T I

BOAZ
 BROTHER
 CUSTOM
 ELDERS
 GATE

INHERITANCE
 KINSMAN
 LAND
 NAME
 NAOMI

REDEEM
 RUIN
 RUTH
 SANDAL

WRITE DOWN THE LETTERS IN THE BOXES AS YOU COME TO THEM ON THE LINES BELOW

→	B		L									O
		E						D	E			
				S						R		L
								B	D		E	
		S								E		
										T	H	

69. BOAZ REDEEMS RUTH

(RUTH 4:1-13)

MEMORY VERSE:

"As for our Redeemer, the LORD of hosts is His name, the Holy One of Israel." ISAIAH 47:4

FILL IN THE BLANKS:

1. Now Boaz "took ten men of the elders of the city, and said, 'Sit down here.' So they sat down. Then he said to the near _____, 'Naomi, who has come back from the country of Moab, _____ the piece of land which belonged to our brother Elimelech.'" **RUTH 4:2-3**

TRUE OR FALSE:

2. "Boaz said, 'On the day you buy the field from the hand of Naomi, you must also buy it from Ruth the Moabitess, the wife of the dead, to raise up the name of the dead on his inheritance.'" **RUTH 4:5**

TRUE OR FALSE

FILL IN THE BLANKS:

3. "And the near kinsman said, 'I cannot redeem it for myself, lest I ruin my own inheritance. You redeem my right of _____ for yourself, for I cannot redeem it.'" **RUTH 4:6**
4. "Now this was the custom in former times in Israel concerning _____ and _____, to confirm anything: one man took off his sandal and gave it to the other." **RUTH 4:7**
5. "Therefore the near kinsman said to Boaz, 'Buy it for yourself.' So he took off his _____." **RUTH 4:8**
6. "So Boaz took Ruth and she became his _____." **RUTH 4:13**

TRUE OR FALSE:

7. "Then the women said to Naomi, 'Blessed be the LORD, who has not left you this day without a near kinsman; and may his name be famous in Israel.'" **RUTH 4:14**

TRUE OR FALSE

The neighbor women gave the child of Naomi and Boaz "a name, saying, 'There is a son born to Naomi.' And they called his name Obed. He is the father of Jesse, the father of David. RUTH 4:17

69. BOAZ REDEEMS RUTH

(RUTH 4:1-13)

E G R V F P N T A E T V Z X W T O U P K I E M L U
 L M V D M U K T Y P O C O D T W U M L M S E J J W
 M Q N D Q T O D M I M C A F L B I F J L G J Q B I
 G H G E S I B D R O J S A N D A L O B U J A V B A
 M V M Z Q N N U Q Y T H K B A H I E J G P V E K C
 B A D Z V D T H U B K S U E O J B Z A O B K V J L
 N V P O P H H Q E B G R U H A Y R P S R E D L E P
 P G K W B R F C Q R H E N C P K W K H C Z U V K A
 M S S H Q A V U T P I M U T A P K J T V F O L U I
 W N P Q J Z I J H P G T D L D G I F J M B Z A M E
 N B P I I E O K T Y D Q A U Y K N Y Y E X X I X Y
 G K R L C M N S T F D N L N S G S T R E K A L Y A
 K K X H T D H M R O V N A W C P M W D D M M R R Q
 B O G T C W I J R J B Y U L M E A U C E Z Z U T A
 Y J O A J Q U B W W G M F Q U S N G G R X B U T O
 K Q S Y T X A T R S C A L N M O G H S U I T C C Y
 P S L O W E F A P O Z S Y I S T T L Q B Z P Q M E
 U P K A Y I F A N S T V H S E W I V U N F Z N P A
 Y M W V J T T U K I H H X V J I M S M H Z F R M E
 F B V C T A Q E B A K Y E U M H O U J X X V U L Q
 K B J A N L H N C G K K O R G J A X Q A D F K C U
 T O N L A B A N D W R W I U O D N H L U K H B S T
 G H W O S Z I Q W A E L R A V U K U J V X N I G V
 E S E Z L U U N M F N W F D S O W Q T A U E F E S
 Y S L M R Z U N I M C W Y D P L I T W E Y E W Y E

BOAZ
BROTHER
CUSTOM
ELDERS
GATE

INHERITANCE
KINSMAN
LAND
NAME
NAOMI

REDEEM
RUIN
RUTH
SANDAL

WRITE DOWN THE LETTERS IN THE BOXES AS YOU COME TO THEM ON THE LINES BELOW

→	B		L								O	
		E					D	E				
				S					R		L	
							B	D		E		
		S							E			
									T	H		
"												"

69. BOAZ REDEEMS RUTH

(RUTH 4:1-13)

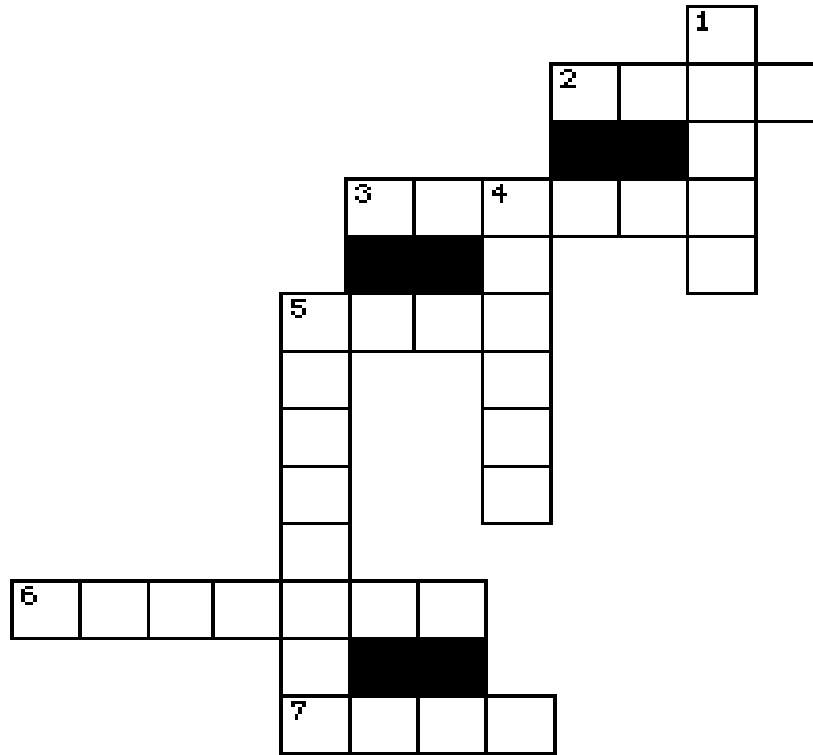

- 5 DOWN "As for our _____, the LORD of hosts is His name, the Holy One of Israel." **ISAIAH 47:4**
- 6 ACROSS Now Boaz "took ten men of the elders of the city, and said, 'Sit down here.' So they sat down. Then he said to the near _____, 'Naomi, who has come back from the country of Moab, sold the piece of land which belonged to our brother Elimelech.'" **RUTH 4:2-3**
- 2 ACROSS "_____ said, 'On the day you buy the field from the hand of Naomi, you must also buy it from Ruth the Moabitess, the wife of the dead, to raise up the name of the dead on his inheritance.'" **RUTH 4:5**
- 5 ACROSS "And the near kinsman said, 'I cannot redeem it for myself, lest I _____ my own inheritance. You redeem my right of redemption for yourself, for I cannot redeem it.'" **RUTH 4:6**
- 3 ACROSS "Now this was the _____ in former times in Israel concerning redeeming and exchanging, to confirm anything: one man took off his sandal and gave it to the other." **RUTH 4:7**
- 4 DOWN "Therefore the near kinsman said to Boaz, 'Buy it for yourself.' So he took off his _____." **RUTH 4:8**
- 7 ACROSS "So Boaz took _____ and she became his wife." **RUTH 4:13**
- 1 DOWN "Then the women said to _____, 'Blessed be the LORD, who has not left you this day without a near kinsman; and may his name be famous in Israel.'" **RUTH 4:14**

Bible Story 70

HANNAH

1 SAMUEL 1:1-19

70. HANNAH
(1 SAMUEL 1:1-19)



"She was in bitterness of soul, and prayed to the LORD and wept in anguish."
1 SAMUEL 1:10

70. HANNAH

(1 SAMUEL 1:1-19)

MEMORY VERSE:

"She was in bitterness of soul, and prayed to the LORD and wept in anguish." 1 SAMUEL 1:10

FILL IN THE BLANK:

1. Hannah "made a vow and said, 'O LORD of hosts, if You will indeed look on the affliction of Your maidservant and remember me, and not forget Your maidservant, but will give your maidservant a male child, then I will _____ him to the LORD all the days of his life, and no razor shall come upon his head.'" **1 SAMUEL 1:11**

CIRCLE THE CORRECT WORDS:

2. "Now Hannah spoke in her ____; only her lips moved, but her voice was not heard. Therefore Eli thought she was drunk." **1 SAMUEL 1:13**
HEAD HEART
3. "And Hannah answered and said, "No, my lord, I am a woman of sorrowful spirit. I have drunk neither wine nor intoxicating drink, but have poured out my ____ before the LORD." **1 SAMUEL 1:15**
CUP SOUL
4. "Eli answered and said, "Go in ____ and the God of Israel grant your petition which you have asked of Him." **1 SAMUEL 1:17**
PEACE HASTE

TRUE OR FALSE:

5. Hannah went on her way and was still sad. **1 SAMUEL 1:18**
TRUE OR FALSE
6. Then Elkanah and Hannah "rose early in the morning and worshiped before the LORD, and returned and came to their house." **1 SAMUEL 1:19**
TRUE OR FALSE

70. HANNAH
(1 SAMUEL 1:1-19)

S W U B S C E R J D G K S U Q
T O G L D N H E A R T S O H F
L E U A G P M Y Q O W Y E I R
M E F L P D E P I H S R O W C
E B Y E T H A N N A H M Z P G
Z D N Z E N H R L O D F P K T
I V O C C L A E P K K L M P D
I N I E V C K V V P A A E R O
D P T L U M Y A R Z L W O R W
Z Y I I D C Y X N E G L E E J
P G T L I E M V C A S K U N V
Z N E W P L Y H G S H D V A H
V W P C N P I A Y T S I I I Y
U Y I A S L B T R V A Q F A N
D Z F Z D R P O Q P M S I P M

ELI

LORD

PRAYED

ELKANAH

MAIDSERVANT

SOUL

HANNAH

MALE CHILD

WEPT

HEART

PETITION

WORSHIPED

70. HANNAH

(1 SAMUEL 1:1-19)

MEMORY VERSE:

"She was in bitterness of soul, and prayed to the LORD and wept in anguish." 1 SAMUEL 1:10

FILL IN THE BLANKS:

1. Hannah "made a vow and said, 'O LORD of hosts, if You will indeed look on the affliction of Your maidservant and remember me, and not forget Your maidservant, but will give your maidservant a male child, then I will _____ him to the LORD all the days of his life, and no razor shall come upon his head.' " **1 SAMUEL 1:11**
2. "Now Hannah spoke in her _____; only her lips moved, but her voice was not heard." **1 SAMUEL 1:13**

TRUE OR FALSE:

3. Therefore Eli thought she was praying. **1 SAMUEL 1:13**
TRUE OR FALSE
4. "And Hannah answered and said, "No, my lord, I am a woman of sorrowful spirit. I have drunk neither wine nor intoxicating drink, but have poured out my soul before the LORD." **1 SAMUEL 1:15**
TRUE OR FALSE

CIRCLE THE CORRECT WORD:

5. "Eli answered and said, "Go in _____ and the God of Israel grant your petition which you have asked of Him." **1 SAMUEL 1:17**
PEACE HASTE

TRUE OR FALSE:

6. Hannah went on her way and was still sad. **1 SAMUEL 1:18**
TRUE OR FALSE
7. Then Elkanah and Hannah "rose early in the morning and worshiped before the LORD, and returned and came to their house." **1 SAMUEL 1:19**
TRUE OR FALSE

70. HANNAH

(1 SAMUEL 1:1-19)

D U J F F R U O S S Q B E Y B D L G S M
 V U H A N A W A M N J N B D X O G N Z U
 U O G W F A D L B P V G P Y B F S W N O
 L V T X T J O K A M Q B U B U R Z B W T
 S V B P H Y K N K N D L U H A N A K L E
 S R A B E G J T I Q D L R A L Q R W M M
 O F X Y D W Q M N D D N J N Y R O A I G
 V W H K T H T G E A V X Z N L K L B O Q
 Z P P Y N S Z P Y Q V Z T A H E L V V O
 D W T T Y E I G N H V R F H C D U B M T
 C V Q P B H P O T E A S E H L P O H G H
 X G P S S Q I T L E D V I S K H S L D P
 O J O R P T Q I H V K L J O D L J O O W
 P T O J I M L E F Z D M F J E I L Y T W
 O W N T X B A L Z U P O E C Y D A K C X
 R F E V U X L S B D S N O V A I L M U L
 J P C D L C L V W F H G R G R P A E V R
 Y G X T N B M O C H P I I W P M G O N Q
 M J B T Z B V P S G P C Y H K W H J V C
 G W I Q H Y S Z L U R N S H X D R O L R

ELI

MAIDSERVANT

SOUL

ELKANAH

MALECHILD

VOW

HANNAH

PETITION

WEPT

HEART

PRAYED

WORSHIPED

LORD

70. HANNAH

(1 SAMUEL 1:1-19)

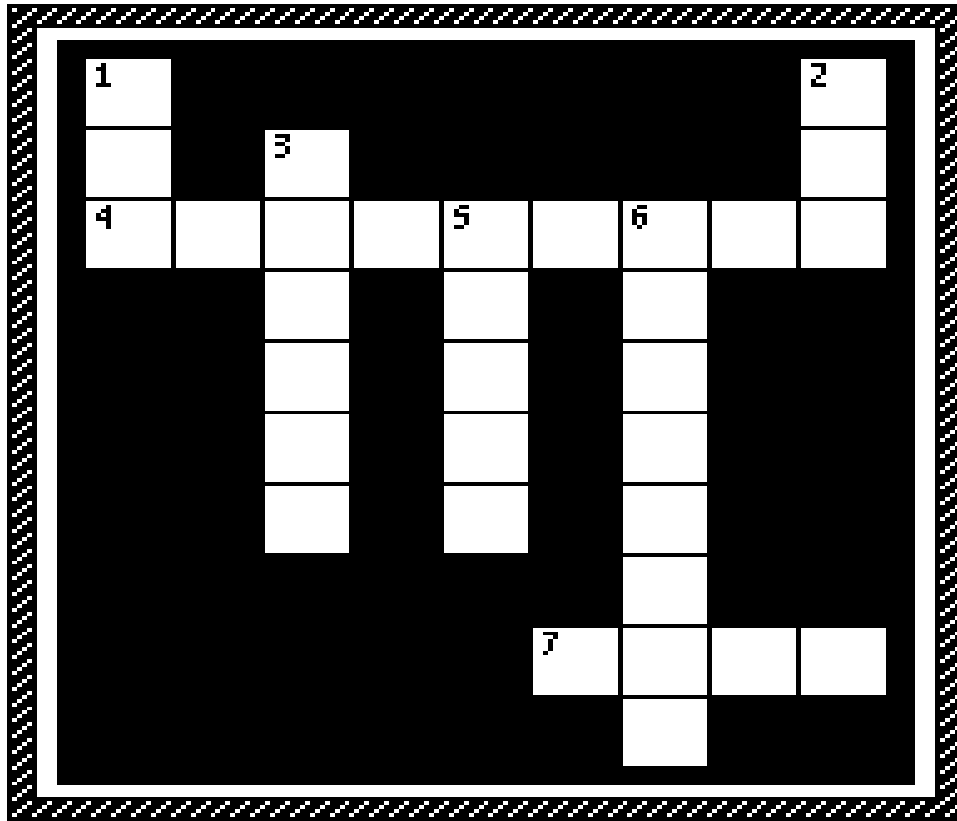

- 3 DOWN "She was in bitterness of soul, and _____ to the LORD and wept in anguish." **1 SAMUEL 1:10**
- 1 DOWN Hannah "made a _____ and said, 'O LORD of hosts, if You will indeed look on the affliction of Your maidservant and remember me, and not forget Your maidservant, but will give your maidservant a male child, then I will give him to the LORD all the days of his life, and no razor shall come upon his head.'" **1 SAMUEL 1:11**
- 5 DOWN "Now Hannah spoke in her _____; only her lips moved, but her voice was not heard. Therefore Eli thought she was drunk." **1 SAMUEL 1:13**
- 7 ACROSS "And Hannah answered and said, "No, my lord, I am a woman of sorrowful spirit. I have drunk neither wine nor intoxicating drink, but have poured out my _____ before the LORD." **1 SAMUEL 1:15**
- 6 DOWN "Eli answered and said, "Go in peace and the God of Israel grant your _____ which you have asked of Him." **1 SAMUEL 1:17**
- 2 DOWN Hannah "went her way and ate, and her face was no longer _____." **1 SAMUEL 1:18**
- 4 ACROSS Then Elkanah and Hannah "rose early in the morning and _____ before the LORD, and returned and came to their house." **1 SAMUEL 1:19**

Bible Story 71

SAMUEL IS BORN

1 SAMUEL 1:20-28

71. SAMUEL IS BORN

(1 SAMUEL 1:20-28)

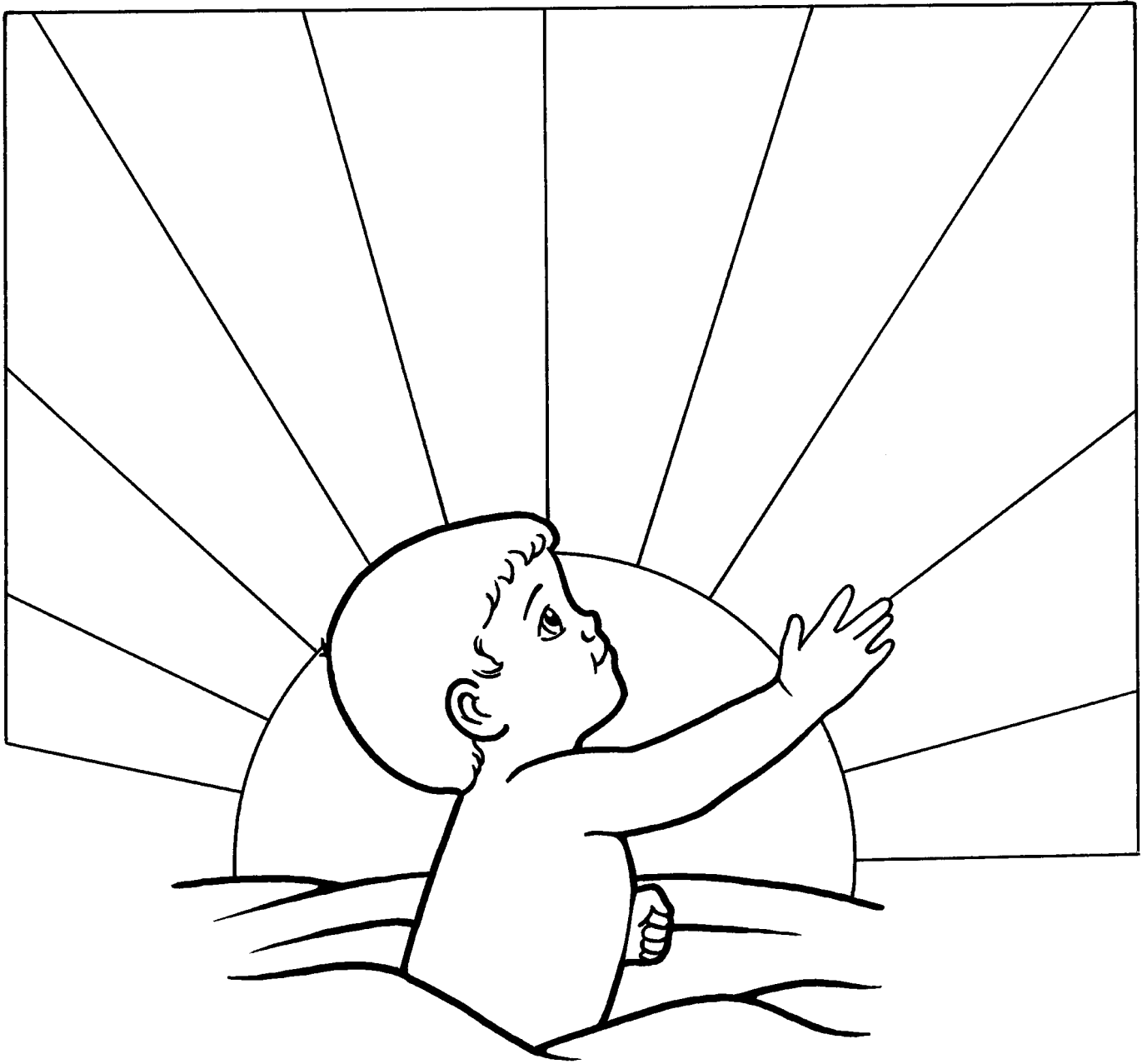

"Wherefore it came to pass, when the time was come about after Hannah had conceived, that she bare a son, and called his name Samuel, *saying*, Because I have asked him of the LORD."

1 SAMUEL 1:20

71. SAMUEL IS BORN

(1 SAMUEL 1:20-28)

F D E Y A R P A G K T O I Y H
 O B J G V T M N D S E T Q Y M
 P Y N X V A X M E H A A D O L
 E N S G B Q T G H Q A M J F S
 O M H A N A K L E O J N U V V
 O H Z R Q P Y P P J L N N E O
 C L K Q Y H L H Z B E I Q A L
 H D B I E P I A C B N R H F H
 I D E P I H S R O W T D R S J
 L R Z P L J O W C R Z E I S J
 D E F H N T V X Q B Z N L V E
 C U H Z V B Q P I J J A S M A
 P E T I T I O N W E C E T A W
 F W N I Q I Z E Z F T W F Z L
 K D R O L A U S K J I P A S Z

CHILD
 ELKANAH
 HANNAH
 LENT

LORD
 PETITION
 PRAYED
 SAMUEL

SHILOH
 WEANED
 WORSHIPED

WRITE DOWN THE LETTERS AS YOU COME TO THEM ON THE LINES BELOW

→ F — O — R — T —
 S — I — H —
 C — H — I — L —
 A — R — P — I — D —
 Y — E — D —

71. SAMUEL IS BORN

(1 SAMUEL 1:20-28)

MEMORY VERSE:

"For this child I prayed, and the LORD has granted me my petition which I asked of Him." 1 SAMUEL 1:27

UNDERLINE THE CORRECT ANSWER:

1. "So it came to pass in the process of time that Hannah conceived and bore a son, and called his name Samuel, saying..." **1 SAMUEL 1:20**
 - a. Because I have asked for him from the LORD
 - b. Because I deserve him

TRUE OR FALSE:

2. "Elkanah and all his house went up to offer to the LORD the yearly sacrifice and his vow." **1 SAMUEL 1:21**

TRUE OR FALSE

3. And Hannah went with her husband and brought with her Samuel. **1 SAMUEL 1:22**

TRUE OR FALSE

FILL IN THE BLANKS:

4. "Now when she had weaned him, she took him up with her, with three bulls, one ephah of flour, and a skin of wine, and brought him to the house of the LORD in _____. And the child was young." **1 SAMUEL 1:24**
5. "Then they slaughtered a _____, and brought the child to Eli." **1 SAMUEL 1:25**
6. "And she said, "O my lord! As your soul lives, my lord, I am the woman who stood by you here, _____ to the LORD." **1 SAMUEL 1:26**
7. "For this child I _____, and the LORD has granted me my petition which I asked of Him." **1 SAMUEL 1:27**
8. "Therefore I also have lent him to the LORD; _____ he shall be lent to the LORD." **1 SAMUEL 1:28**

TRUE OR FALSE:

9. "So they worshiped the LORD there." **1 SAMUEL 1:28**

TRUE OR FALSE

71. SAMUEL IS BORN

(1 SAMUEL 1:20-28)

U Y S V X O Q T Z A N P P P W H E U F W
 Y K N N W A J N Z F T N N Y A K M N B T
 Y P B D E V H D N S A M U E L K Q U E L
 R U R G W C I A K F J A N F F R N D H A
 R O M D L O C R N T M Y B O U E Y L T O
 L Y K P V A R A O N S Q C J H O L I H S
 H R O K D L T S B Q A U D E T N M U L A
 E K J S D O C Z H H M H W L O G A F U P
 L T Q P Z Z J E D I J Q K K M N S L W A
 M G S P Z M W M H E P T I A J I V E L I
 G C P R O F Y D S A N E E N K Y Y Y Q D
 M E H X W P J W V U T A D A G A K H N Y
 B Y M I H M E Q I U A H E H H R W X I S
 P G B O L Q T T T N E L P W G P L O S M
 M M B S Q D N X I T A T I W D C W I V U
 W Q O L I S A I O T U T Y S V V W R U N
 N H H K L Q S T N T I R B S B C Z F U S
 G V S W H V L A H D E O B I L W O Y A E
 K V S V T P P L I D N R N A C H A X D J
 B G R J Y B U B U Q Q W P G Z R K D D M

CHILD
 ELI
 ELKANAH
 HANNAH

LENT
 LORD
 PETITION
 PRAYING

SAMUEL
 SHILOH
 WEANED
 WORSHIPED

WRITE DOWN THE LETTERS AS YOU COME TO THEM ON THE LINES BELOW

→ F — O — R — T —
 S — I — H —
 C — H — I — I —
 A — R — P — I — D —
 Y — E — D — →

71. SAMUEL IS BORN

(1 SAMUEL 1:20-28)

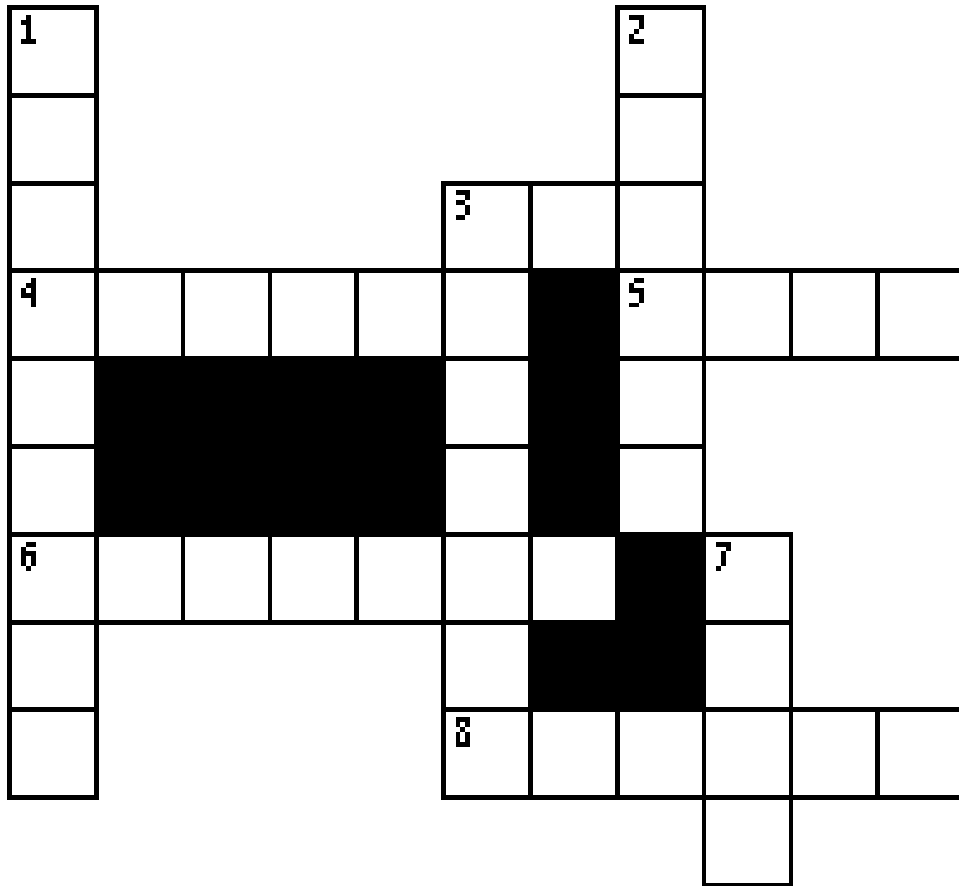

- 4 ACROSS "So it came to pass in the process of time that Hannah conceived and bore a son, and called his name _____, saying, 'Because I have asked for him from the LORD.'" **1 SAMUEL 1:20**
- 3 DOWN "_____ and all his house went up to offer to the LORD the yearly sacrifice and his vow." **1 SAMUEL 1:21**
- 8 ACROSS "But _____ did not go up." **1 SAMUEL 1:22**
- 2 DOWN "Now when she had weaned him, she took him up with her, with three bulls, one ephah of flour, and a skin of wine, and brought him to the house of the LORD in _____. And the child was young." **1 SAMUEL 1:24**
- 3 ACROSS "Then they slaughtered a bull, and brought the child to _____." **1 SAMUEL 1:25**
- 6 ACROSS "And she said, 'O my lord! As your soul lives, my lord, I am the woman who stood by you here, _____ to the LORD.'" **1 SAMUEL 1:26**
- 5 ACROSS "For this child I prayed, and the _____ has granted me my petition which I asked of Him." **1 SAMUEL 1:27**
- 7 DOWN "Therefore I also have _____ him to the LORD; as long as he lives he shall be lent to the LORD." **1 SAMUEL 1:28**
- 1 DOWN "So they _____ the LORD there." **1 SAMUEL 1:28**

Bible Story 72

**ELI & HIS
WICKED SONS**

1 SAMUEL 2:12-36

72. ELI & HIS WICKED SONS (1 SAMUEL 2:12-36)



"Now the sons of Eli *were* sons of Belial; they knew not the LORD."
1 SAMUEL 2:12

72. ELI & HIS WICKED SONS (1 SAMUEL 2:12-36)

MEMORY VERSE:

"For those who honor Me I will honor, and those who despise Me shall be lightly esteemed." 1 SAMUEL 2:30

CIRCLE THE CORRECT WORDS:

1. "Now the sons of Eli were _____, they did not know the Lord." 1 SAMUEL 2:12
GOOD CORRUPT
2. "But Samuel ministered before the LORD, even as a _____, wearing a linen ephod." 1 SAMUEL 2:18
CHILD SHEPHERD
3. Eli said to his sons, "No, my sons! For it is not a good report that I hear. _____ make the LORD'S people transgress." 1 SAMUEL 2:24
YOU I

FILL IN THE BLANK:

4. "If one man sins against another, _____ will judge him. But if a man sins against the LORD, who will intercede for him?" 1 SAMUEL 2:25

TRUE OR FALSE:

5. "Nevertheless they did not heed the voice of their father, because the LORD desired to kill them." 1 SAMUEL 2:25

TRUE OR FALSE

6. "And the child Samuel grew in stature, and in favor both with the LORD and men." 1 SAMUEL 2:26

TRUE OR FALSE

"A man of God came to Eli and said, 'Thus says the LORD:' "

7. Now this shall be a sign to you that will come upon your two sons, on Hophni and Phinehas: in one day one shall die, one of them. 1 SAMUEL 2:34

TRUE OR FALSE

FILL IN THE BLANK:

8. "Then I will raise up for Myself a _____ priest who shall do according to what is in My heart and in My mind." 1 SAMUEL 2:35

72. ELI & HIS WICKED SONS

(1 SAMUEL 2:12-36)

S A M U E L S D S E
 R K F T J G I L I B
 W I O A P E U I N O
 G L E R I U L H S R
 R E T O T T R C T L
 O W R N F S H R P J
 V I O O Y H E F O B
 A U P H T M H I U C
 F M E P W V U Q R L
 T F R M P S O N S P

CHILD	FAVOR	ROBE
CORRUPT	HONOR	SAMUEL
DIE	PRIEST	SINS
ELI	REPORT	SONS
FAITHFUL		

WRITE DOWN ALL THE LETTERS EXCEPT X AS YOU COME TO THEM

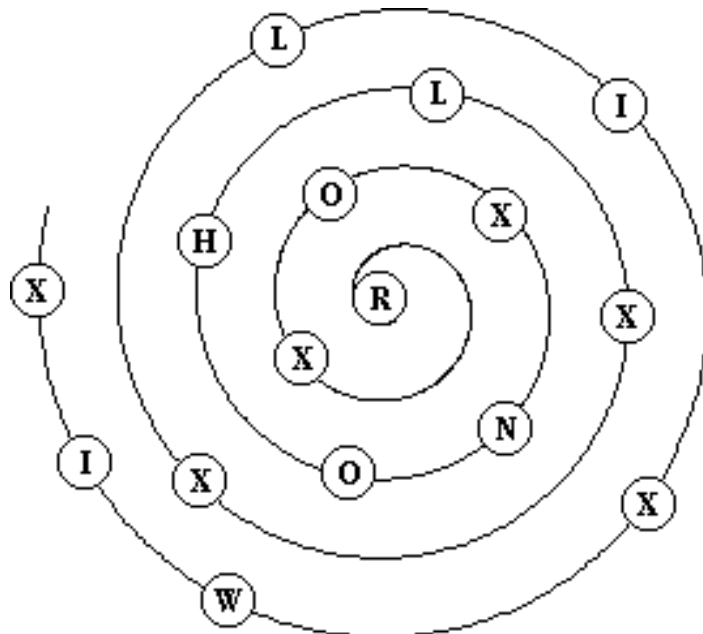

"For those who honor Me...

and those who despise Me shall be lightly esteemed."

1 SAMUEL 2:30

72. ELI & HIS WICKED SONS (1 SAMUEL 2:12-36)

MEMORY VERSE:

"For those who honor Me I will honor, and those who despise Me shall be lightly esteemed." 1 SAMUEL 2:30

FILL IN THE BLANKS:

1. "Now the sons of Eli were _____, they did not know the Lord." 1 SAMUEL 2:12
2. "But Samuel ministered before the LORD, even as a _____, wearing a linen ephod." 1 SAMUEL 2:18
3. Eli said to his sons, "No, my sons! For it is not a good report that I hear. _____ make the LORD'S people transgress." 1 SAMUEL 2:24
4. "If one man sins against another, _____ will judge him. But if a man sins against the LORD, who will intercede for him?" 1 SAMUEL 2:25

TRUE OR FALSE:

5. "Nevertheless they did not heed the voice of their father, because the LORD desired to kill them." 1 SAMUEL 2:25

TRUE OR FALSE

6. "And the child Samuel grew in stature, and in favor both with the LORD and men." 1 SAMUEL 2:26

TRUE OR FALSE

"A man of God came to Eli and said, 'Thus says the LORD:' "

7. Now this shall be a sign to you that will come upon your two sons, on Hophni and Phinehas: in one day one shall die, one of them. 1 SAMUEL 2:34

TRUE OR FALSE

FILL IN THE BLANKS:

8. "Then I will raise up for Myself a _____ priest who shall do according to what is in My heart and in My mind." 1 SAMUEL 2:35
9. "I will build him a _____ house, and he shall walk before My anointed forever." 1 SAMUEL 2 :35

72. ELI & HIS WICKED SONS (1 SAMUEL 2:12-36)

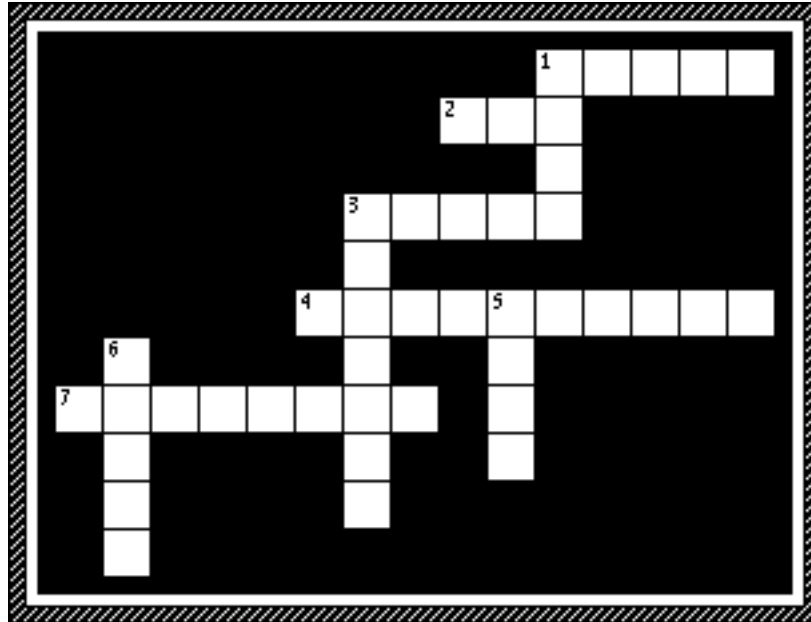

- 3 DOWN "Now the sons of Eli were _____, they did not know the Lord." **1 SAMUEL 2:12**
- 3 ACROSS "But Samuel ministered before the LORD, even as a _____, wearing a linen ephod." **1 SAMUEL 2:18**
- 4 ACROSS Eli said to his sons, "No, my sons! For it is not a good report that I hear. You make the LORD'S people _____." **1 SAMUEL 2:24**
- 5 DOWN "If one man _____ against another, God will judge him. But if a man sins against the LORD, who will intercede for him?" **1 SAMUEL 2:25**
- 1 DOWN "Nevertheless they did not _____ the voice of their father, because the LORD desired to kill them. " **1 SAMUEL 2:25**
- 6 DOWN "And the child Samuel grew in stature, and in _____ both with the LORD and men." **1 SAMUEL 2:26**
- 1 ACROSS "For those who _____ Me I will honor, and those who despise Me shall be lightly esteemed." **1 SAMUEL 2:30**
- 2 ACROSS "Now this shall be a sign to you that will come upon your two sons, on Hophni and Phinehas: in one day they shall _____, both of them." **1 SAMUEL 2:34**
- 7 ACROSS "Then I will raise up for Myself a _____ priest who shall do according to what is in My heart and in My mind." **1 SAMUEL 2:35**

Bible Story 73

SAMUEL IS CALLED

1 SAMUEL 3:1-20

73. SAMUEL IS CALLED

(1 SAMUEL 3:1-20)



"So Samuel grew, and the LORD was with him and let none of his words fall to the ground." **1 SAMUEL 3:19**

73. SAMUEL IS CALLED

(1 SAMUEL 3:1-20)

C A L L E D N Q H Q
A L A K F C P E D J
L S T M Z W A H L V
K V E I A R O E F Q
N P H Y S I U R H D
M Z P T L M E V D D
G S O O A S M R G S
G M R S I L N Z E D
T D P L B S Q U U H
E B E I S R A E L V

CALLED
ELI
HEARS

HERE I AM
ISRAEL
LORD

PROPHET
SAMUEL
WORDS

WRITE DOWN THE LETTERS AS YOU COME TO THEM ON THE LINES BELOW

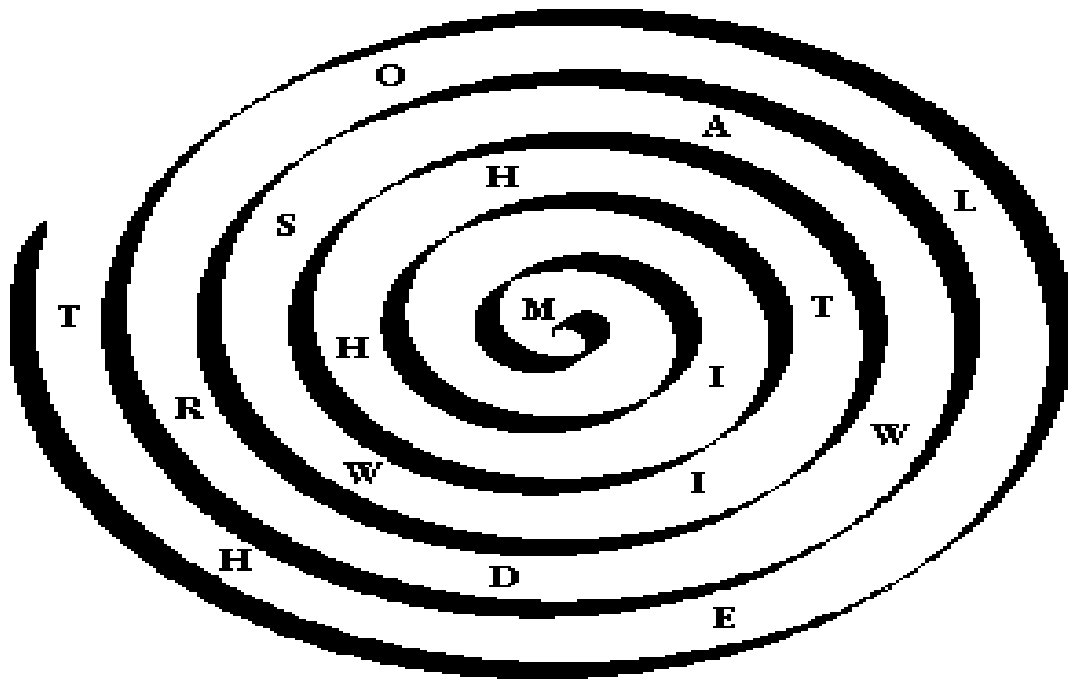

"-----"

73. SAMUEL IS CALLED

(1 SAMUEL 3:1-20)

G F G M G X W W V S C P W O T
M M S B L W P R O P H E T B Q
B S N M O E E H C Q J U Q H H
P T R R I O A Q A V D R O L A
M G D A D N L R L P W T T F M
W S B B E S I I S B Y N I V M
N E E L I H L S O I J D T I T
G Y R O P L V E T Q T R A O T
R C M H H K D L U E N A L N D
B G A S K E D H Z M R Z B H D
Y M O L S W R T M J A E Z I Q
K Q J S L V Z E F I A S D U C
P H Q R P E Z Y I C S E Z A U
U V S V P J D O M A L M N F J
Y V P N R X O A Q T M D M F M

CALLED
ELI
HEARS
HERE I AM

ISRAEL
LORD
MINISTERED

PROPHET
SAMUEL
WORDS

WRITE DOWN THE LETTERS AS YOU COME TO THEM ON THE LINES BELOW

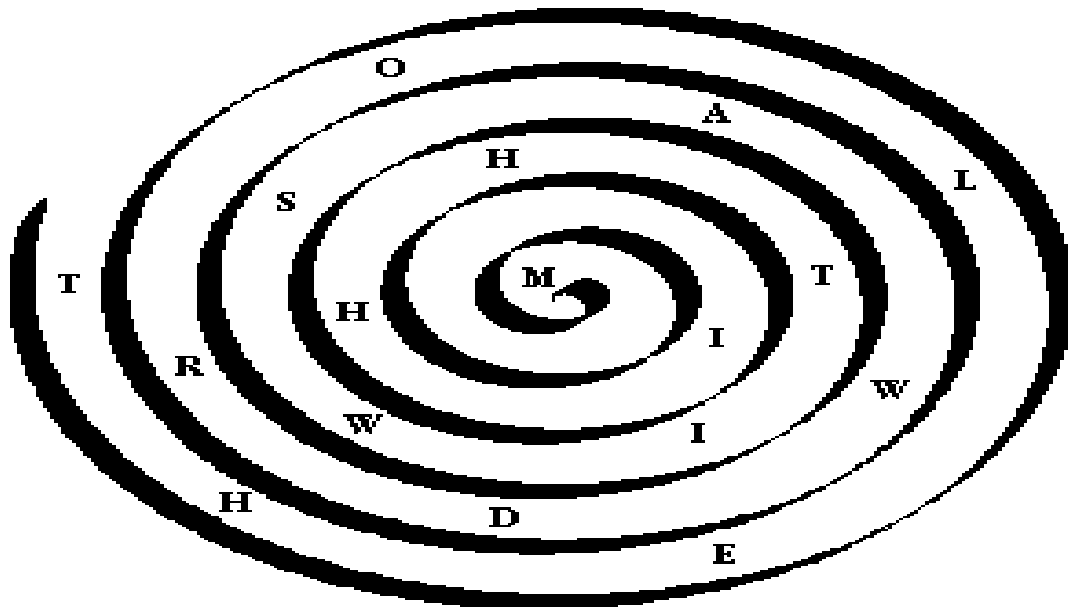

73. SAMUEL IS CALLED

(1 SAMUEL 3:1-20)

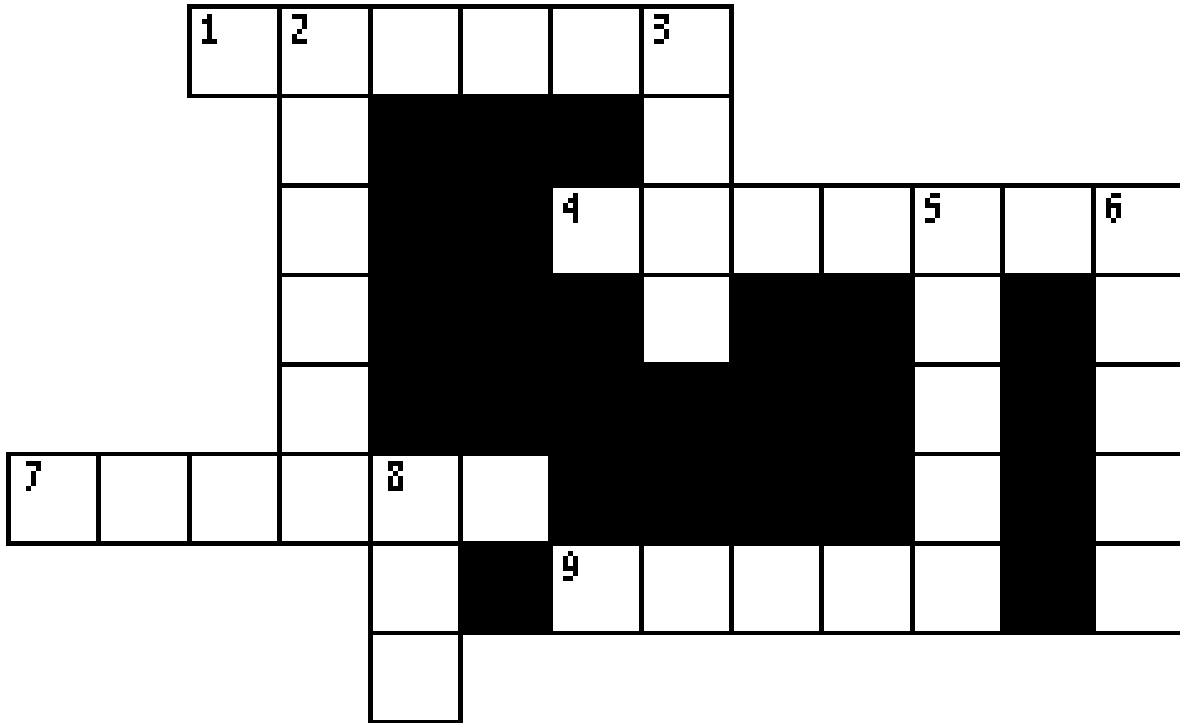

- 2 DOWN "The boy _____ ministered to the LORD before Eli." **1 SAMUEL 3:1**
- 3 DOWN "The _____ called Samuel. And he answered, 'Here I am!' " **1 SAMUEL 3:4**
- 8 DOWN "So he ran to _____ and said, 'Here I am, for you called me.' And he said, 'I did not call; lie down again.' And he went and lay down." **1 SAMUEL 3:5**
- 7 ACROSS "And the LORD _____ yet again, 'Samuel!' " **1 SAMUEL 3:6**
- 6 DOWN "And the LORD called Samuel again the _____ time. So he arose and went to Eli, and said, 'Here I am, for you did call me.' Then Eli perceived that the LORD had called the boy." **1 SAMUEL 3:8**
- 5 DOWN "Now the LORD came and stood and called as at other times, 'Samuel! Samuel!' And Samuel answered, 'Speak, for Your servant _____.'" **1 SAMUEL 3:9**
- 1 ACROSS "Then the LORD said to Samuel; 'Behold I will do something in _____ at which both ears of everyone who hears it will tingle.'" **1 SAMUEL 3:11**
- 9 ACROSS "So Samuel grew, and the LORD was with him and let none of his _____ fall to the ground." **1 SAMUEL 3:19**
- 4 ACROSS "And all Israel from Dan to Beersheba knew that Samuel had been established as a _____ of the LORD." **1 SAMUEL 3:20**

Bible Story 74

**THE CAPTURE
& RETURN
OF THE ARK**

1 SAMUEL 4:1-7:2

74. THE CAPTURE & RETURN OF THE ARK

(1 SAMUEL 4:1-7:2)

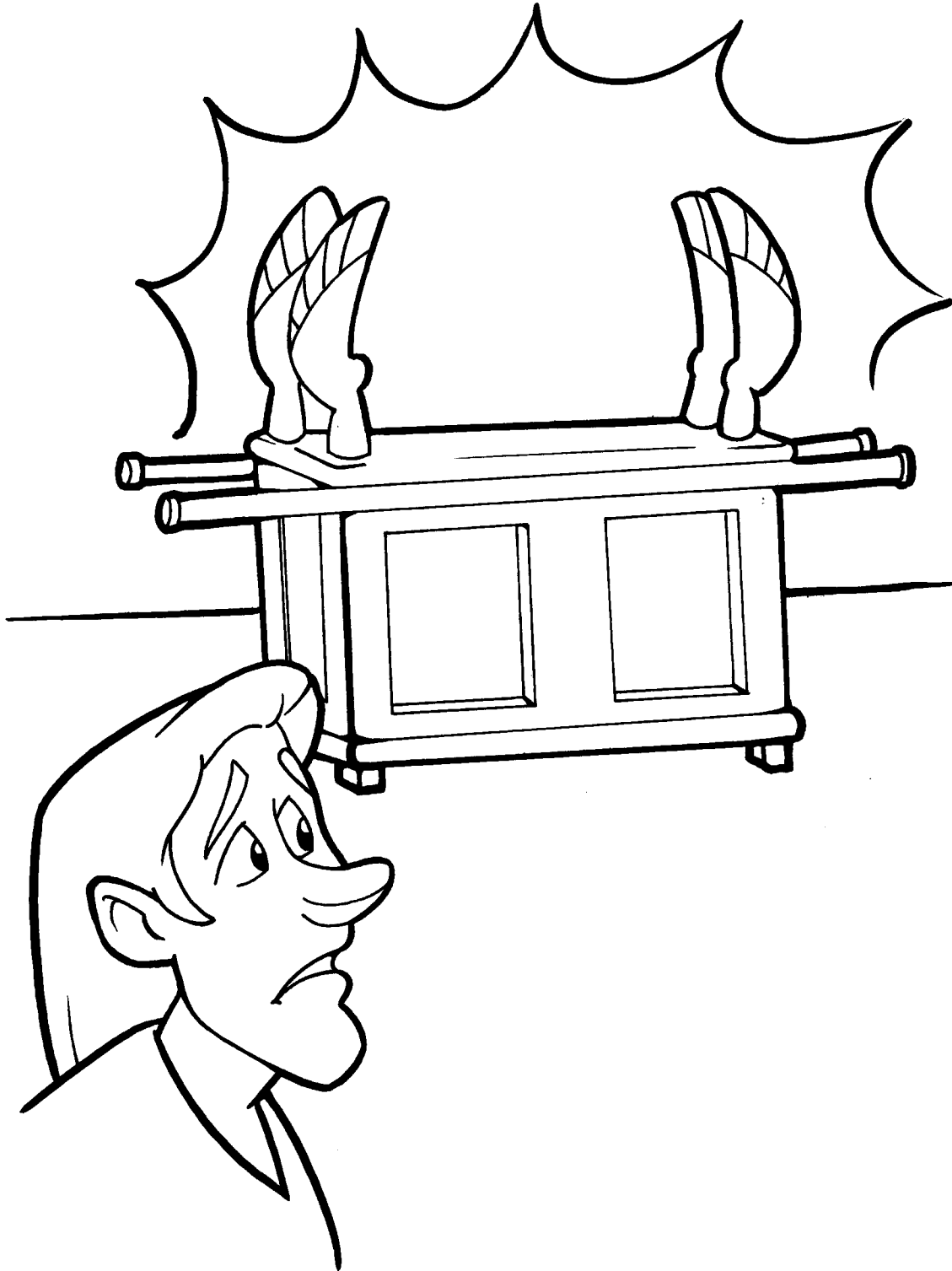

"And when they of Ashdod arose early on the morrow, behold, Dagon was fallen upon his face to the earth before the ark of the LORD. And they took Dagon, and set him in his place again."

1 SAMUEL 5:3

74. THE CAPTURE & RETURN OF THE ARK

(1 SAMUEL 4:1-7:2)

R L Z C Z B Y T W N H U K Q T
V K O A S Q J N Q K I U S P R
N D W P M R T D N O U T M N R
G W E L H J E I S R A E L A W
D V H T F I N G I B A T J Y P
P J Q O A I L R N H F D T Q N
K L I D M E D I T E F D A U K
S W L D A C F E S S S Q A Q B
P E H E Q G A E N T R S U T C
P L T R S T O A D R I O E H D
R V Y U A C S N A F U N M M W
X D O T Q R L Z L V T T E U K
O D A P V J K E B I Q C E S T
A F R A I D P M Z O H U E R I
S Z V C P W U D Z N A J N T E

AFRAID
ARK
CAPTURED
DAGON

DEFEATED
ISRAEL
MESSENGERS

PHILISTINES
RETURNED
TUMORS



74. THE CAPTURE & RETURN OF THE ARK

(1 SAMUEL 4:1-7:2)

MEMORY VERSE:

"And the men of Beth Shemesh said, 'Who is able to stand before this holy LORD God?' " 1 SAMUEL 6:20

FILL IN THE BLANKS:

1. "Now Israel went out to battle against the _____." 1 SAMUEL 4:1
2. "And when they joined battle, Israel was _____ by the Philistines." 1 SAMUEL 4:2
3. The elders of Israel said, "Let us bring the _____ of the covenant of the LORD from Shiloh to us, that when it comes among us it may save us from the hand of our enemies." 1 SAMUEL 4:3
4. "When the ark of the covenant of the LORD came into the camp, all Israel shouted so loudly that the _____ shook." 1 SAMUEL 4:5

TRUE OR FALSE:

5. "So the Philistines were afraid, for they said, 'God has come into the camp!' And they said, 'Woe to us! For such a thing has never happened before.' " 1 SAMUEL 4:7
TRUE OR FALSE
6. So the Philistines gave up and ran for their lives. 1 SAMUEL 4:9-10
TRUE OR FALSE
7. "The ark of God was captured; and the two sons of Eli, Hophni and Phinehas, died." 1 SAMUEL 4:11
TRUE OR FALSE
8. "And when the Philistines took the ark of God, they brought it into the house of Dagon and set it by Dagon." 1 SAMUEL 5:2
TRUE OR FALSE

FILL IN THE BLANKS:

9. "When the people of Ashod arose early in the morning, there was Dagon, fallen on its _____ to the earth before the ark of the LORD. So they took Dagon and set it in its place again." 1 SAMUEL 5:3
10. "The hand of the LORD was heavy on the people of Ashod, and He ravaged them and struck them with _____, both Ashod and its territory." 1 SAMUEL 5:6
11. After the ark brought destruction upon Gath, it was sent to Ekron and the people "sent and gathered together all the lords of the Philistines, and said, "Send away the ark of the God of Israel, and let it go back to its own place, so that it does not _____ us or our people." 1 SAMUEL 5:11

TRUE OR FALSE:

12. "So they sent messengers to the inhabitants of Kirjath Jearim, saying, 'The Philistines have brought back the ark of the LORD; come down and take it up with you.' " 1 SAMUEL 6:21
TRUE OR FALSE

74. THE CAPTURE & RETURN OF THE ARK

(1 SAMUEL 4:1-7:2)

C S B A H F W F S N B V W L F C I Q J L
Z L B B U M E Y A P P G E F I G M M O A
R B Z R S E E I R C R Y A L U O Q R J S
D M M N Y T B B K M Y Q R K H W D H C P
Y I W E J L D D E N R U T E R G B M X W
Q O N A N M V B D C R M H I O J V G V J
Q N Y F D S N L G T E D I D I V B Q D H
H K L R Y E E A P S E S D Q P H W W I N
F E N A I Z P N S P R O K S K Y D G M F
O Y D I B I Y E I A X O A S R E Y X O G
I T C D L I N E E T V K G O F G N W O I
H E V W O G G L C R S P S E E M O D F E
H T O G E D N Z V E T I A E N G G I U G
Q Z U R U Z W C U M O T L Z A U A C D W
U Q S M P P Y L I H E Z A I I V D P I K
F V S F O Z Z W P D J S M P H E U L V H
U L K Z W R D E R U T P A C P P K O E O
M S L A C V S C N Y Q T K E Q Z Y P M L
N R D N P U U A S Y L V S U F U H D N Y
V S F S R D G Z C M P G Y V R U F Q B O

AFRAID
ARK
CAPTURED
DAGON
DEFEATED

EARTH
HOLY
ISRAEL
LORD GOD

MESENTERS
PHILISTINES
RETURNED
TUMORS

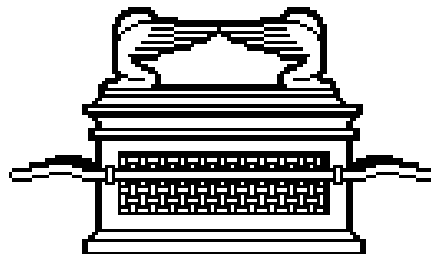

74. THE CAPTURE & RETURN OF THE ARK

(1 SAMUEL 4:1-7:2)

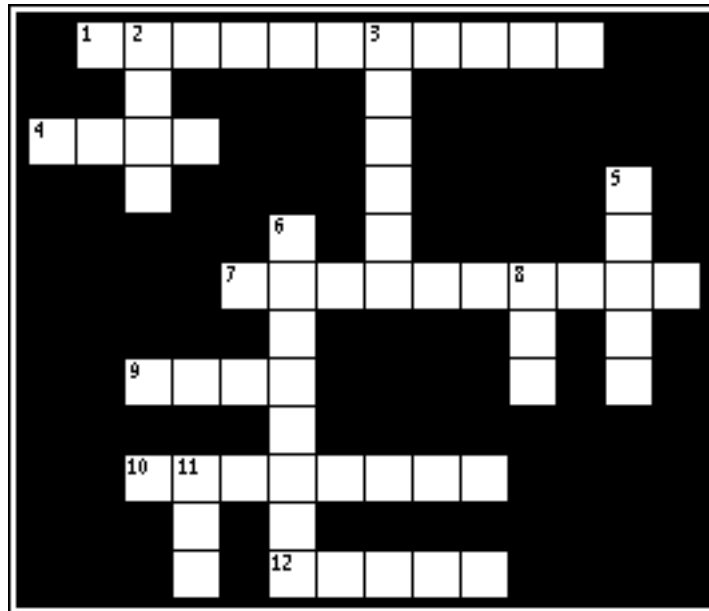

- 1 ACROSS "Now Israel went out to battle against the ____." **1 SAMUEL 4:1**
- 6 DOWN "And when they joined battle, Israel was ____ by the Philistines." **1 SAMUEL 4:2**
- 11 DOWN The elders of Israel said, "Let us bring the ____ of the covenant of the LORD from Shiloh to us, that when it comes among us it may save us from the hand of our enemies." **1 SAMUEL 4:3**
- 5 DOWN "When the ark of the covenant of the LORD came into the camp, all Israel shouted so loudly that the ____ shook." **1 SAMUEL 4:5**
- 8 DOWN "So the Philistines were afraid, for they said, '____ has come into the camp!' And they said, 'Woe to us! For such a thing has never happened before.'" **1 SAMUEL 4:7**
- 10 ACROSS "The ark of God was ____; and the two sons of Eli, Hophni and Phinehas, died." **1 SAMUEL 4:11**
- 12 ACROSS "And when the Philistines took the ark of God, they brought it into the house of ____ and set it by Dagon." **1 SAMUEL 5:2**
- 9 ACROSS "When the people of Ashod arose early in the morning, there was Dagon, fallen on its ____ to the earth before the ark of the LORD." **1 SAMUEL 5:3**
- 3 DOWN "The hand of the LORD was heavy on the people of Ashod, and He ravaged them and struck them with ____, both Ashod and its territory." **1 SAMUEL 5:6**
- 4 ACROSS "Send away the ark of the God of Israel, and let it go back to its own place, so that it does not ____ us or our people." **1 SAMUEL 5:11**
- 2 DOWN "And the men of Beth Shemesh said, 'Who is able to stand before this ____ LORD God?' " **1 SAMUEL 6:20**
- 7 ACROSS "So they sent ____ to the inhabitants of Kirjath Jearim" **1 SAMUEL 6:21**

Bible Story 75

**SAUL IS MADE
KING OF ISRAEL**

1 SAMUEL 9:1-12:25

75. SAUL IS MADE KING OF ISRAEL

(1 SAMUEL 9:1-12:25)



"And he had a son, whose name *was* Saul, a choice young man, and a goodly: and *there was* not among the children of Israel a goodlier person than he: from his shoulders and upward *he was* higher than any of the people."

1:SAMUEL 9:2

75. SAUL IS MADE KING OF ISRAEL

(1 SAMUEL 9:1-12:25)

MEMORY VERSE:

"Only fear the LORD, and serve Him in truth with all your heart; for consider what great things He has done for you." 1 SAMUEL 12:24

CIRCLE THE CORRECT WORDS:

1. Saul was "a choice and handsome young man. There was not a more handsome person than he among the children of Israel. From his shoulders upward he was (**TALLER, SMALLER**) than any of the people." **1:SAMUEL 9:2**
2. "When Samuel saw Saul, the LORD said to him, 'There he is, the man of whom I spoke to you. This one shall (**JUMP, REIGN**) over My people.'" **1 SAMUEL 9:17**
3. "Saul answered and said, 'Am I not a Benjamite, of the (**SMALLEST, LARGEST**) of the tribes of Israel, and my family the (**LEAST, GREATEST**) of all the families of the tribe of Benjamin?' " **1 SAMUEL 9:21**

TRUE OR FALSE:

4. "Samuel took a flask of oil and poured it on his head." **1 SAMUEL 10:1**
TRUE OR FALSE

FILL IN THE BLANKS:

5. "Then Samuel called the people together to the LORD at Mizpah, and said to the children of Israel, 'I brought up Israel out of Egypt, and delivered you from the hand of the Egyptians and from the hand of _____ kingdoms and from those who oppressed you.'" **1 SAMUEL 10:17-18**
6. "But you have today rejected your God, who Himself saved you from all your adversities and your tribulations; and you have said to Him, 'No, set a _____ over us!' Now therefore, present yourselves before the LORD by your tribes and by your clans." **1 SAMUEL 10:19**

CIRCLE THE CORRECT WORDS:

7. "Samuel said to all the people, 'Do you see him whom the (**MAN, LORD**) has chosen, that there is no one like him among all the people?' So all the people shouted and said, 'Long live the king!' " **1 SAMUEL 10:24**
8. "Now Samuel said to all Israel, 'Indeed I have (**IGNORED, HEEDDED**) your voice in all that you said to me, and have made a king over you.'" **1 SAMUEL 12:1**

TRUE OR FALSE:

9. Samuel said to the people, "If you fear the LORD and serve Him and obey His voice, and do not rebel against the commandment of the LORD, then both you and the king who reigns over you will continue following the LORD your God." **1 SAMUEL 12:14**
TRUE OR FALSE
10. "However, if you do not obey the voice of the LORD, but rebel against the commandment of the LORD, then the hand of the LORD will be against you, as it was against your fathers." **1 SAMUEL 12:15**
TRUE OR FALSE

75. SAUL IS MADE KING OF ISRAEL

(1 SAMUEL 9:1-12:25)

G W Z A M J J U D Z O Q Q U T
D V O V E S B E N J A M I T E
P H W C A M T T W N N H C E H
K J A M O I O N Q K T S A E L
S J U P Q M N S M O H A U N T
P E H C Z C M D D B I U J Q T
L W Q S S I D A I N U U K X R
P E I A A T M E N T A T S N R
R T L L Q U A R D D R H M A W
X L A O V C L A T E M A J Y P
O V H L K J S Z A H E E E Q N
S D T Z L I L E L F A H N H K
L D Y M P E N M B L F T T T B
L O R D B W R G I V F D A U C
K Z O F Q Y P O Z I T D A Q D

BENJAMITE
COMMANDMENT
HANDSOME
HEART
HEEDED

KING
LEAST
LORD
MIZPAH

OIL
SAMUEL
SAUL
TALLER

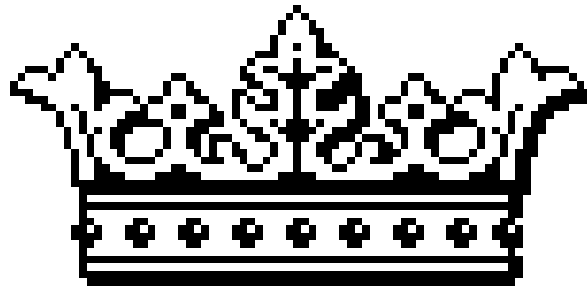

75. SAUL IS MADE KING OF ISRAEL

(1 SAMUEL 9:1-12:25)

MEMORY VERSE:

"Only fear the LORD, and serve Him in truth with all your heart; for consider what great things He has done for you." 1 SAMUEL 12:24

FILL IN THE BLANKS:

1. Saul was "a choice and handsome young man. There was not a more handsome person than he among the children of Israel. From his shoulders upward he was _____ than any of the people." **1:SAMUEL 9:2**
2. "When Samuel saw Saul, the LORD said to him, 'There he is, the man of whom I spoke to you. This one shall _____ over My people.' " **1 SAMUEL 9:17**
3. "Saul answered and said, 'Am I not a Benjamite, of the _____ of the tribes of Israel, and my family the _____ of all the families of the tribe of Benjamin?'" **1 SAMUEL 9:21**

TRUE OR FALSE:

4. "Samuel took a flask of oil and poured it on his head." **1 SAMUEL 10:1**
TRUE OR FALSE

FILL IN THE BLANKS:

5. "Then Samuel called the people together to the LORD at Mizpah, and said to the children of Israel, 'I brought up Israel out of Egypt, and delivered you from the hand of the Egyptians and from the hand of _____ kingdoms and from those who oppressed you.'" **1 SAMUEL 10:17-18**
6. "But you have today rejected your God, who Himself saved you from all your adversities and your tribulations; and you have said to Him, 'No, set a _____ over us!' Now therefore, present yourselves before the LORD by your tribes and by your clans." **1 SAMUEL 10:19**
7. "Samuel said to all the people, 'Do you see him whom the _____ has chosen, that there is no one like him among all the people?' So all the people shouted and said, 'Long live the king!'" **1 SAMUEL 10:24**
8. "Now Samuel said to all Israel, 'Indeed I have _____ your voice in all that you said to me, and have made a king over you.'" **1 SAMUEL 12:1**

TRUE OR FALSE:

9. Samuel said to the people, "If you fear the LORD and serve Him and obey His voice, and do not rebel against the commandment of the LORD, then both you and the king who reigns over you will continue following the LORD your God." **1 SAMUEL 12:14**
TRUE OR FALSE
10. "However, if you do not obey the voice of the LORD, but rebel against the commandment of the LORD, then the hand of the LORD will be against you, as it was against your fathers." **1 SAMUEL 12:15**
TRUE OR FALSE

75. SAUL IS MADE KING OF ISRAEL

(1 SAMUEL 9:1-12:25)

D S P Q M Q B S S F B M E Y G R J S I K
V J C C E Q M B K Z L E B I P E Q T I E
A F P F K H I B L A O Z D F C M L N Q N
I P Q C Y F O Z D N U I V B V H G V S A
Z K X J B O N H A P Z I M B U Y H G S I
P A V K Z I K F O S P H E L I Y E W O P
M R L V U T E W I H A N N A P M A D E Q
E K I L F H N B L N J I P E N B R K Z F
O H J E J H Y E D A W D L E A S T A P R
G I L U U Q T S M P C Z Y Z S A P G E C
E T J M M U O I F D P P G C L P V S U G
L J H A K M T Y A S N Z N L C R G A V O
F H L S E E E D B Y R A E L N Y Y L F W
J B Q O B F Z L R J F R M W P R Q K I J
M C H B D M Q N R O M V W M C E D S U V
L G Y Y C M V D P N L U Y C O M O Y H H
E U O D Z N D E D E E H Z A B C O L I Y
H H A G R V L C E D E D U Z C V K F P G
E G F S D S S V W Y T W G S N T P L K M
I Q G C Y L R O G I L E F D P O Z K R X

BENJAMITE
COMMANDMENT
HANDSOME
HEART
HEEDED

KING
LEAST
LORD
MIZPAH

OIL
SAMUEL
SAUL
TALLER

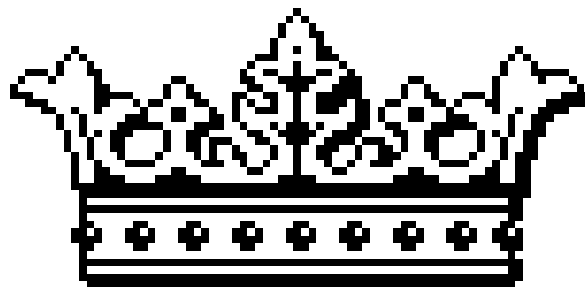

75. SAUL IS MADE KING OF ISRAEL

(1 SAMUEL 9:1-12:25)

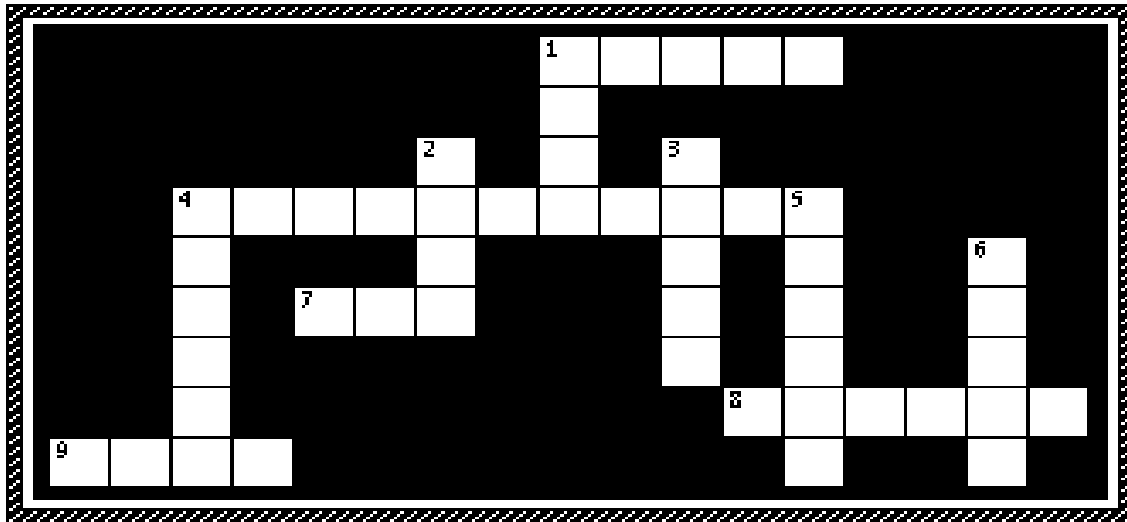

- 5 DOWN "There was not a more handsome person than he among the children of Israel. From his shoulders upward he was _____ than any of the people." **1: SAMUEL 9:2**
- 2 DOWN "When Samuel saw _____, the LORD said to him, 'There he is, the man of whom I spoke to you. This one shall reign over My people.'" **1 SAMUEL 9:17**
- 1 ACROSS "Saul answered and said, 'Am I not a Benjamite, of the smallest of the tribes of Israel, and my family the _____ of all the families of the tribe of Benjamin?'" **1 SAMUEL 9:21**
- 7 ACROSS "Samuel took a flask of _____ and poured it on his head." **1 SAMUEL 10:1**
- 1 DOWN "Then Samuel called the people together to the _____ at Mizpah." **1 SAMUEL 10:17**
- 9 ACROSS "But you have today rejected your God, who Himself saved you from all your adversities and your tribulations; and you have said to Him, 'No, set a _____ over us!' Now therefore, present yourselves before the LORD by your tribes and by your clans." **1 SAMUEL 10:19**
- 4 DOWN "Samuel said to all the people, 'Do you see him whom the LORD has _____, that there is no one like him among all the people?' So all the people shouted and said, 'Long live the king!'" **1 SAMUEL 10:24**
- 8 ACROSS "Now Samuel said to all Israel, 'Indeed I have _____ your voice in all that you said to me, and have made a king over you.'" **1 SAMUEL 12:1**
- 4 ACROSS Samuel said to the people, "If you fear the LORD and serve Him and obey His voice, and do not rebel against the _____ of the LORD, then both you and the king who reigns over you will continue following the LORD your God." **1 SAMUEL 12:14**
- 6 DOWN "However, if you do not obey the voice of the LORD, but _____ against the commandment of the LORD, then the hand of the LORD will be against you, as it was against your fathers." **1 SAMUEL 12:15**
- 3 DOWN "Only fear the LORD, and serve Him in truth with all your _____; for consider what great things He has done for you." **1 SAMUEL 12:24**

Bible Story 76

**JONATHAN'S FIGHT
& SAUL'S OATH**

1 SAMUEL 14:1-46

76. JONATHAN'S FIGHT & SAUL'S OATH (1 SAMUEL 14:1-46)



"And that first slaughter, which Jonathan and his armourbearer made, was about twenty men, within as it were an half acre of land, *which a yoke of oxen might plow.*" **1 SAMUEL 14:14**

"But Jonathan heard not when his father charged the people with the oath: wherefore he put forth the end of the rod that *was* in his hand, and dipped it in an honeycomb, and put his hand to his mouth; and his eyes were enlightened." **1 SAMUEL 14:27**

76. JONATHAN'S FIGHT & SAUL'S OATH

(1 SAMUEL 14:1-46)

MEMORY VERSE:

"For nothing restrains the LORD from saving by many or by few." 1 SAMUEL 14:6

TRUE OR FALSE:

1. "Now it happened one day that Jonathan, the son of Saul, said to the young man who bore his armor, 'Come, let us go over to the Philistines' garrison that is on the other side.' But he did not tell his father." 1 SAMUEL 14:1

TRUE OR FALSE

2. "Then Jonathan said to the young man who bore his armor, 'Come let us go over to the garrison of these uncircumcised; it may be that the LORD will work for us. For nothing restrains the LORD from saving by many or by few.'" 1 SAMUEL 14:6

TRUE OR FALSE

CIRCLE THE CORRECT WORD:

3. "That first slaughter which Jonathan and his armorbearer made was about (TEN, TWENTY) men within about half an acre of land." 1 SAMUEL 14:14

TRUE OR FALSE:

4. "And the men of Israel were distressed that day, for Saul had placed the people under oath, saying 'Cursed is the man who eats any food until evening, before I have taken vengeance on my enemies.' So none of the people tasted food." 1 SAMUEL 14:24

TRUE OR FALSE

CIRCLE THE CORRECT WORDS:

5. "But (JONAH, JONATHAN) had not heard his father charge the people with the oath; therefore he stretched out the end of the rod that was in his hand and dipped it in a honeycomb, and put his hand to his mouth, and his countenance brightened." 1 SAMUEL 14:27

6. Now Jonathan said, "How much (BETTER, WORSE) if the people had eaten freely today of the spoil of their enemies which they found! For now would there not have been a much greater slaughter among the Philistines?" 1 SAMUEL 14:30

7. "Saul said to Jonathan, 'Tell me what you have done.' And Jonathan told him, and said, 'I only tasted a little honey with the end of the rod that was in my hand. So now I must (LIVE, DIE)!' " 1 SAMUEL 14:43

TRUE OR FALSE:

8. Saul answered, "No my son, you shall surely not die!" 1 SAMUEL 14:44

TRUE OR FALSE

FILL IN THE BLANK:

9. "The people said to Saul, 'Shall Jonathan die, who has accomplished this great salvation in Israel? Certainly not! As the LORD lives, not one hair of his head shall fall to the ground, for he has worked with God this day.' So the people _____ Jonathan, and he did not die." 1 SAMUEL 14:45

76. JONATHAN'S FIGHT & SAUL'S OATH

(1 SAMUEL 14:1-46)

G F S B D S D L L P Y N X O A
M K N B N L H O N E Y C O M B
B H B P O E D H O B J D I B F
P T T R H L M T Z Q L U A S F
M G D A P I Z Y M J T R T H T
W E K O O K L Y T I N A A F Q
N Y D I E W N I F N A Z L V H
G G K H K V Z A S C E E B I A
K R O S S J O O H T S W Z O U
B M E S P P W A M T I M T N U
Y Q J S P W D O O F A N Z H T
K H Q R C E H V Q T L N E I T
P V S V R U Q C S C P D O S D
U V P N X L E A Q J U W N J D
Y G M G O V I D V W T Q K U Q

DIE
FOOD
HONEYCOMB
JONATHAN

LORD
OATH
PHILISTINES

RESCUED
SAUL
TWENTY MEN

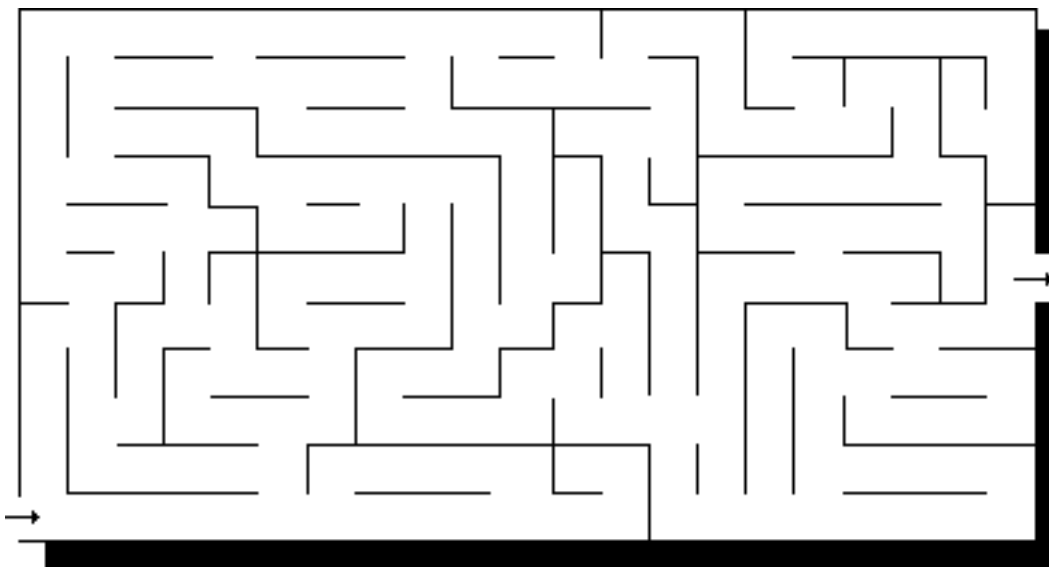

76. JONATHAN'S FIGHT & SAUL'S OATH

(1 SAMUEL 14:1-46)

MEMORY VERSE:

"For nothing restrains the LORD from saving by many or by few." 1 SAMUEL 14:6

TRUE OR FALSE:

1. "Now it happened one day that Jonathan, the son of Saul, said to the young man who bore his armor, 'Come, let us go over to the Philistines' garrison that is on the other side.' But he did not tell his father." 1 SAMUEL 14:1

TRUE OR FALSE

2. "Then Jonathan said to the young man who bore his armor, 'Come let us go over to the garrison of these uncircumcised; it may be that the LORD will work for us. For nothing restrains the LORD from saving by many or by few.'" 1 SAMUEL 14:6

TRUE OR FALSE

FILL IN THE BLANK:

3. "That first slaughter which Jonathan and his armorbearer made was about _____ men within about half an acre of land." 1 SAMUEL 14:14

UNDERLINE THE CORRECT ANSWER:

4. "And the men of Israel were distressed that day, for Saul had placed the people under oath, saying 'Cursed is the man who eats any food until evening, before I have taken vengeance on my enemies.'" 1 SAMUEL 14:24
- a. So all the people ate until they could eat no more
b. So none of the people tasted food

FILL IN THE BLANKS:

5. "But Jonathan _____ his father charge the people with the oath; therefore he stretched out the end of the rod that was in his hand and dipped it in a honeycomb, and put his hand to his mouth, and his countenance brightened." 1 SAMUEL 14:27
6. Now Jonathan said, "How much _____ if the people had eaten freely today of the spoil of their enemies which they found! For now would there not have been a much greater slaughter among the Philistines?" 1 SAMUEL 14:30
7. "Saul said to Jonathan, 'Tell me what you have done.' And Jonathan told him, and said, 'I only tasted a little honey with the end of the rod that was in my hand. So now I must _____!' " 1 SAMUEL 14:43

TRUE OR FALSE:

8. Saul answered, "No my son, you shall surely not die!" 1 SAMUEL 14:44

TRUE OR FALSE

FILL IN THE BLANK:

9. "The people said to Saul, 'Shall Jonathan die, who has accomplished this great salvation in Israel? Certainly not! As the LORD lives, not one hair of his head shall fall to the ground, for he has worked with God this day.' So the people _____ Jonathan, and he did not die." 1 SAMUEL 14:45

76. JONATHAN'S FIGHT & SAUL'S OATH

(1 SAMUEL 14:1-46)

N C Z F H K D Y D M M Q V Z Z O K P N N
 Z M D W P Y T G O S B Q V S F J K M W W
 C Y C P T T N H F O A H D V J C X W B I
 U S W W Q P Y S O A K V K M F V D L W O
 Z O O V N S B E O L I Z P D E U C S E R
 H J P G O J P S D K Y U S O E G O G T V
 Z I O J N V M Q E B T D H N O W F W B M
 M M R T O A T H M N F F P G R H E S V G
 U O J B C D U O K N I H P I I N M Z B D
 D Y Y G B T C M N M Z T R C T H Q R H O
 D D M J B Y L A J G B G S Y Y B R O C T
 V V G W E T H B Q G C R M I S L K J O C
 V U M N I T N M M T S E B N L B D L Y U
 L P O J A Q Z C Z E N Q N E U I F L K V
 C H U N F F H B P L L J G B A U H A E N
 L S O H A N R B Q S S V B P S L H P O V
 V J O G W F A Y L V N Q L U Y Y L G J M
 N S V B X T A D A P P D L U D L L O R D
 M O V A B H I U L Z M D N R Y H D H S U
 J V R X Y E J W L S N D X J B X I G Z O

DIE
 FOOD
 HONEYCOMB
 JONATHAN

LORD
 OATH
 PHILISTINES

RESCUED
 SAUL
 TWENTY MEN

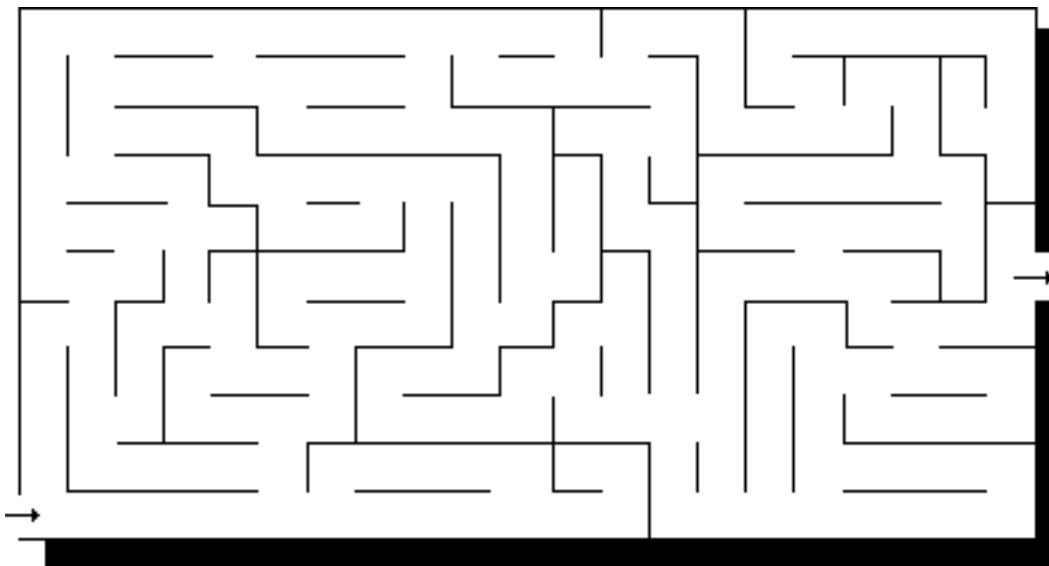

76. JONATHAN'S FIGHT & SAUL'S OATH

(1 SAMUEL 14:1-46)

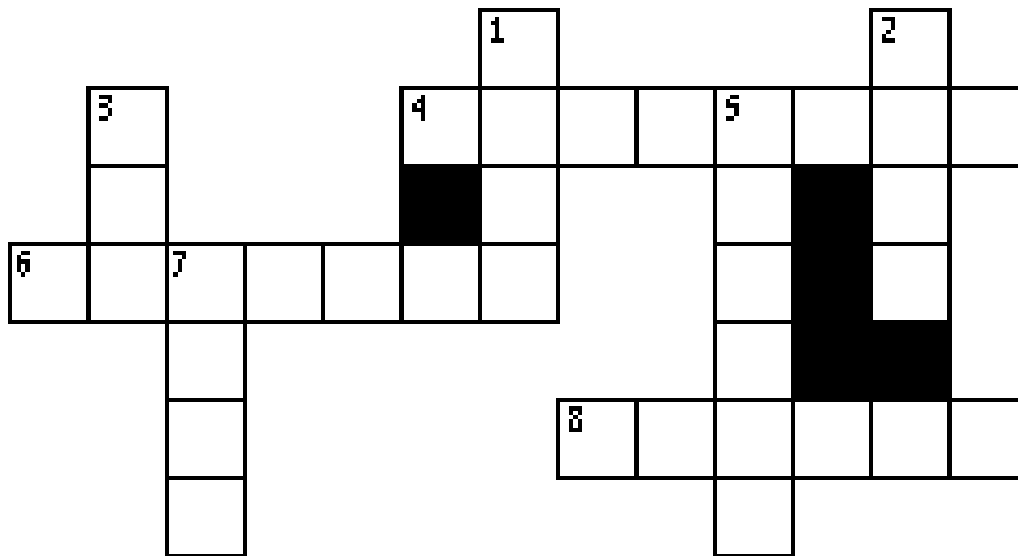

- 4 ACROSS "Now it happened one day that _____, the son of Saul, said to the young man who bore his armor, 'Come, let us go over to the Philistines' garrison that is on the other side.' But he did not tell his father." **1 SAMUEL 14:1**
- 1 DOWN "Then Jonathan said to the young man who bore his armor, 'Come let us go over to the garrison of these uncircumcised; it may be that the _____ will work for us. For nothing restrains the LORD from saving by many or by few.'" **1 SAMUEL 14:6**
- 5 DOWN "That first slaughter which Jonathan and his armorbearer made was about _____ men within about half an acre of land." **1 SAMUEL 14:14**
- 7 DOWN "And the men of Israel were distressed that day, for _____ had placed the people under oath, saying 'Cursed is the man who eats any food until evening, before I have taken vengeance on my enemies.' So none of the people tasted food." **1 SAMUEL 14:24**
- 2 DOWN "But Jonathan had not heard his father charge the people with the _____; therefore he stretched out the end of the rod that was in his hand and dipped it in a honeycomb, and put his hand to his mouth, and his countenance brightened." **1 SAMUEL 14:27**
- 8 ACROSS Now Jonathan said, "How much _____ if the people had eaten freely today of the spoil of their enemies which they found! For now would there not have been a much greater slaughter among the Philistines?" **1 SAMUEL 14:30**
- 3 DOWN "Saul said to Jonathan, 'Tell me what you have done.' And Jonathan told him, and said, 'I only tasted a little honey with the end of the rod that was in my hand. So now I must _____!' " **1 SAMUEL 14:43**
- 6 ACROSS "The people said to Saul, 'Shall Jonathan die, who has accomplished this great salvation in Israel? Certainly not! As the LORD lives, not one hair of his head shall fall to the ground, for he has worked with God this day.' So the people _____ Jonathan, and he did not die." **1 SAMUEL 14:45**

Bible Story 77

**SAUL IS
REJECTED BY GOD**

1 SAMUEL 15:10-35

77. SAUL IS REJECTED BY GOD

(1 SAMUEL 15:10-35)



"Then came the word of the LORD unto Samuel, saying, it repenteth me that I have set up Saul *to be* king: for he is turned back from following me, and hath not performed my commandments. And it grieved Samuel; and he cried unto the LORD all night."

1 SAMUEL 15:10-11

77. SAUL IS REJECTED BY GOD

(1 SAMUEL 15:10-35)

MEMORY VERSE:

"Behold, to obey is better than sacrifice." 1 SAMUEL 15:22

FILL IN THE BLANK:

1. "Now the word of the LORD came to Samuel, saying, 'I greatly _____ that I have set up Saul as king, for he has turned back from following Me, and has not performed My commandments.' And it grieved Samuel, and he cried out to the LORD all night." 1 SAMUEL 15:10-11

TRUE OR FALSE:

2. "Then Samuel went to Saul, and Saul said to him, 'Blessed are you of the LORD! I have performed the commandment of the LORD.' " 1 SAMUEL 15:13

TRUE OR FALSE

3. "But Samuel said, 'What then is this bleating of the sheep in my ears, and the lowing of the oxen which I hear?' " 1 SAMUEL 15:14

TRUE OR FALSE

CIRCLE THE CORRECT WORDS:

4. "And Saul said, 'They have brought them from the Amalekites; for the people (**DESTROYED, SPARED**) the best of the sheep and the oxen, to sacrifice to the LORD your God; and the rest we have utterly destroyed.' " 1 SAMUEL 15:15
5. "Why then did you not (**OBEY, DISOBEY**) the voice of the LORD? Why did you swoop down on the spoil, and do evil in the sight of the LORD?" 1 SAMUEL 15:19
6. "And Saul said to Samuel, 'But I (**HAVE, HAVE NOT**) obeyed the voice of the LORD, and gone on the mission on which the LORD sent me, and brought back Agag, king of Amalek; I have utterly destroyed the Amalekites.' " 1 SAMUEL 15:20
7. Then Samuel said, "Behold, to obey is (**BETTER, WORSE**) than sacrifice." 1 SAMUEL 15:22

TRUE OR FALSE:

8. And Samuel also said, "Because you have rejected the word of the LORD, He also has rejected you from being king." 1 SAMUEL 15:23

TRUE OR FALSE

9. "So Samuel said to him, 'The LORD has torn the kingdom of Israel from you today, and has given it to a neighbor of yours, who is better than you.' " 1 SAMUEL 15:28

TRUE OR FALSE

FILL IN THE BLANK:

10. "And Samuel went no more to see Saul until the day of his death. Nevertheless Samuel _____ for Saul, and the LORD regretted that He had made Saul king over Israel." 1 SAMUEL 15:35

77. SAUL IS REJECTED BY GOD

(1 SAMUEL 15:10-35)

MEMORY VERSE:

"Behold, to obey is better than sacrifice." 1 SAMUEL 15:22

FILL IN THE BLANK:

1. "Now the word of the LORD came to Samuel, saying, 'I greatly _____ that I have set up Saul as king, for he has turned back from following Me, and has not performed My commandments.' And it grieved Samuel, and he cried out to the LORD all night." 1 SAMUEL 15:10-11

TRUE OR FALSE:

2. "Then Samuel went to Saul, and Saul said to him, 'Blessed are you of the LORD! I have performed the commandment of the LORD.'" 1 SAMUEL 15:13

TRUE OR FALSE

3. "But Samuel said, 'What then is this bleating of the sheep in my ears, and the lowing of the oxen which I hear?'" 1 SAMUEL 15:14

TRUE OR FALSE

FILL IN THE BLANKS:

4. "And Saul said, 'They have brought them from the Amalekites; for the people _____ the best of the sheep and the oxen, to sacrifice to the LORD your God; and the rest we have utterly destroyed.'" 1 SAMUEL 15:15

5. "Why then did you not _____ the voice of the LORD? Why did you swoop down on the spoil, and do evil in the sight of the LORD?" 1 SAMUEL 15:19

6. "And Saul said to Samuel, 'But I _____ obeyed the voice of the LORD, and gone on the mission on which the LORD sent me, and brought back Agag, king of Amalek; I have utterly destroyed the Amalekites.'" 1 SAMUEL 15:20

7. Then Samuel said, "Behold, to obey is _____ than sacrifice." 1 SAMUEL 15:22

TRUE OR FALSE:

8. And Samuel also said, "Because you have rejected the word of the LORD, He also has rejected you from being king." 1 SAMUEL 15:23

TRUE OR FALSE

9. "So Samuel said to him, 'The LORD has torn the kingdom of Israel from you today, and has given it to a neighbor of yours, who is better than you.'" 1 SAMUEL 15:28

TRUE OR FALSE

FILL IN THE BLANK:

10. "And Samuel went no more to see Saul until the day of his death. Nevertheless Samuel _____ for Saul, and the LORD regretted that He had made Saul king over Israel." 1 SAMUEL 15:35

77. SAUL IS REJECTED BY GOD

(1 SAMUEL 15:10-35)

W H G J M T Q J P O F V D L B W U Q V S
 X D H Q G F Q V R N J G O G W I O C T N
 B T S P G Z H Q B G F W F S B O X R L U
 Y N E Z T B V D N I E H X Z V V M H C W
 K Y Q P E C G D G C O H Q M O D G N I K
 Y B M Q L N A S B P R B R R B M G N R S
 T P B L S E G D T E E R K O H G Q E M C
 P B B A V X A V C N I E D J C D J N G T
 S N C L P O Z I L N E B H L O E O V K P
 J L B L Z S F V D E Y M F S C O T G M M
 V N B M S I U E L S S U D T Y T H R P S
 D Z Y S R L N D P B T L E N K D K K E D
 T H N C M R D A N E Y D H L A C R L I Q
 T R A O U S R K R P D Y L A E M E O P H
 Q S W O B E F G L U Y L D G O U M Z L E
 F A M A D N E R Z U B H I H M U W O L N
 N A D L A R H S S R O R P A J V W L C P
 L U A S K P G O B E Y K S G S N B B E T
 F J O K I M U H V J J K M N Z V L I N L
 T Y K N Y N Q P M Z C J W W N M R V K Z

AGAG
 COMMANDMENTS
 KINGDOM
 LORD

OBEY
 OXEN
 REGRET
 REJECTED

SAMUEL
 SAUL
 SHEEP
 SPARED

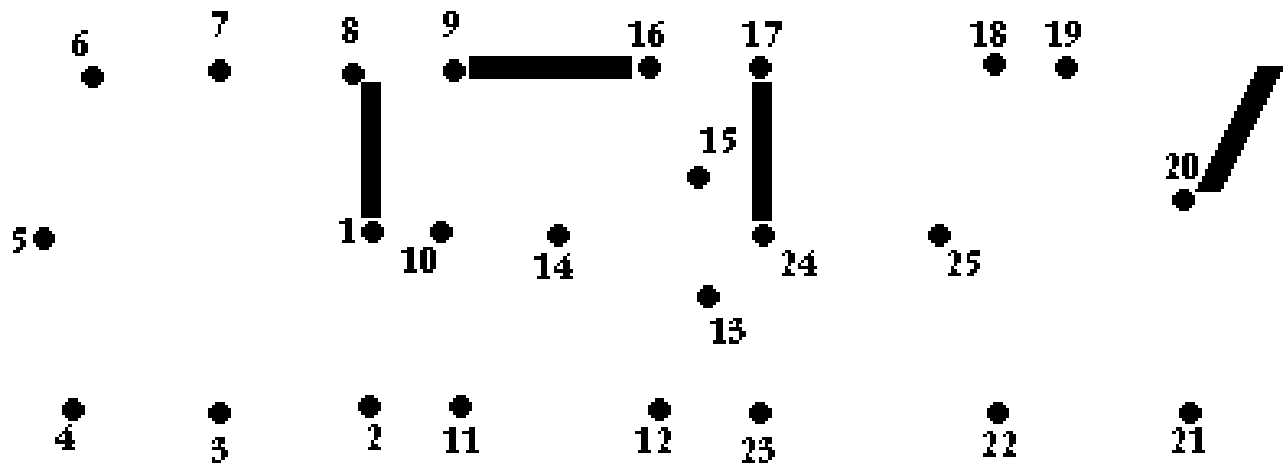

77. SAUL IS REJECTED BY GOD

(1 SAMUEL 15:10-35)

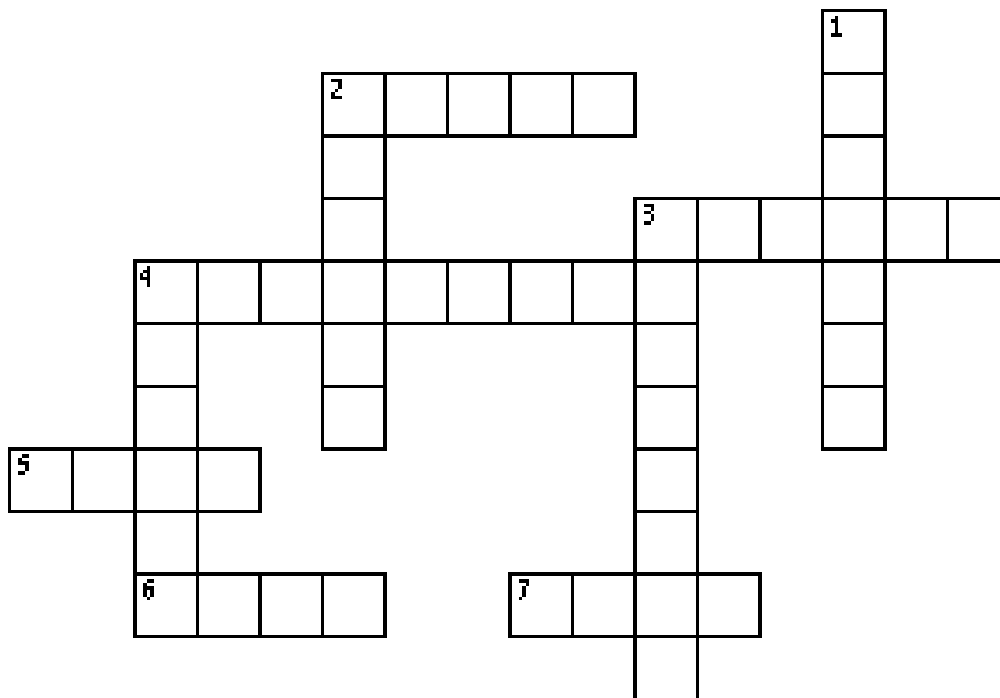

- 3 ACROSS "Now the word of the LORD came to Samuel, saying, 'I greatly _____ that I have set up Saul as king.'" **1 SAMUEL 15:10**
- 4 DOWN "Then _____ went to Saul, and Saul said to him, 'Blessed are you of the LORD! I have performed the commandment of the LORD.'" **1 SAMUEL 15:13**
- 2 ACROSS "But Samuel said, 'What then is this bleating of the _____ in my ears, and the lowing of the oxen which I hear?'" **1 SAMUEL 15:14**
- 2 DOWN "And Saul said, 'They have brought them from the Amalekites; for the people _____ the best of the sheep and the oxen, to sacrifice to the LORD your God.'" **1 SAMUEL 15:15**
- 7 ACROSS "Why then did you not _____ the voice of the LORD?" **1 SAMUEL 15:19**
- 5 ACROSS "And _____ said to Samuel, 'But I have obeyed the voice of the LORD.'" **1 SAMUEL 15:20**
- 4 ACROSS Then Samuel said, "Behold, to obey is better than _____." **1 SAMUEL 15:22**
- 3 DOWN And Samuel also said, "Because you have _____ the word of the LORD, He also has rejected you from being king." **1 SAMUEL 15:23**
- 6 ACROSS "So Samuel said to him, 'The _____ has torn the kingdom of Israel from you today, and has given it to a neighbor of yours, who is better than you.'" **1 SAMUEL 15:28**
- 1 DOWN "And Samuel went no more to see Saul until the day of his death. Nevertheless Samuel _____ for Saul, and the LORD regretted that He had made Saul king over Israel." **1 SAMUEL 15:35**

Bible Story 78

**DAVID IS ANOINTED
KING BY SAMUEL**

1 SAMUEL 16:1-13

78. DAVID IS ANOINTED KING BY SAMUEL (1 SAMUEL 16:1-13)



"Then Samuel took the horn of oil, and anointed him in the midst of his brethren:
and the Spirit of the LORD came upon David from that day forward.
So Samuel rose up, and went to Ramah."

1 SAMUEL 16:13

78. DAVID IS ANOINTED KING BY SAMUEL

(1 SAMUEL 16:1-13)

MEMORY VERSE:

"For the LORD does not see as man sees; for man looks at the outward appearance, but the LORD looks at the heart." 1 SAMUEL 16:7

FILL IN THE BLANKS:

1. "Now the LORD said to Samuel, 'How long will you mourn for Saul, seeing I have rejected him from reigning over Israel? Fill your horn with oil, and go, I am sending you to Jesse the Bethlehemite. For _____ a king among his sons.'" **1 SAMUEL 16:1**

TRUE OR FALSE:

2. "So Samuel did what the LORD said, and went to Bethlehem." **1 SAMUEL 16:4**
TRUE OR FALSE
3. "Then he sanctified Jesse and his sons, and invited them to the sacrifice." **1 SAMUEL 16:5**
TRUE OR FALSE
4. Thus Jesse made seven of his sons pass before Samuel. And Samuel said to Jesse, "The LORD has chosen one of these." **1 SAMUEL 16:10**
TRUE OR FALSE

CIRCLE THE CORRECT WORD:

5. "And Samuel said to Jesse, 'Are all the young men here?' Then he said, 'There remains yet the (YOUNGEST, OLDEST), and there he is, keeping the sheep.'" **1 SAMUEL 16:11**

TRUE OR FALSE:

6. "So he sent and brought him in. Now he was ruddy, with bright eyes, and good-looking." **1 SAMUEL 16:12**
TRUE OR FALSE
7. "And the LORD said, 'Arise, anoint him, for this is the one!' " **1 SAMUEL 16:12**
TRUE OR FALSE

CIRCLE THE CORRECT WORD:

8. "Then Samuel took the horn of oil and anointed him in the midst of his brothers; and the Spirit of the LORD came upon (JESSE, DAVID) from that day forward." **1 SAMUEL 16:13**

78. DAVID IS ANOINTED KING BY SAMUEL

(1 SAMUEL 16:1-13)

Q Z G N I K R O L S O J G I Y
 J O R B A C K T B Z P D M M E
 X V B U L P S Z S A P E F J Q
 B L W W N L S L Y E H L N C T
 H L D N F R V A E E G H M W X
 Z O E Y R Z Y A L U Y N B G B
 Y R I D D P Z H Z T M Z U G K
 Q D F H K D T W N K J A I O S
 P C I E S E N I G I V L S V Y
 V E T A B H O C F L T E U B I
 M G C R F N O H J E S S E A S
 V V N T A M W H L U C S E I S
 O T A H X D I V A D V Q V F X
 T Y S I Y Y K O C H S U M P W
 J E I I D U I F Y B H Z N L J

ANOINT
 BETHLEHEM
 DAVID
 SAMUEL

HEART
 JESSE
 LORD
 KING

SANCTIFIED
 SAUL
 YOUNGEST

WRITE DOWN THE LETTERS AS YOU COME TO THEM ON THE LINES BELOW

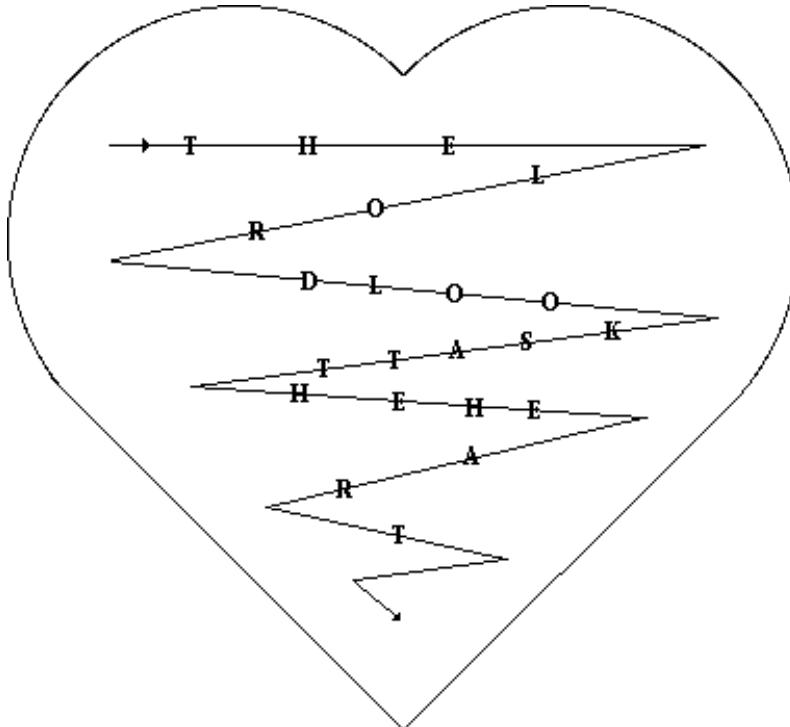

78. DAVID IS ANOINTED KING BY SAMUEL

(1 SAMUEL 16:1-13)

MEMORY VERSE:

"For the LORD does not see as man sees; for man looks at the outward appearance, but the LORD looks at the heart." 1 SAMUEL 16:7

FILL IN THE BLANKS:

1. "Now the LORD said to Samuel, 'How long will you mourn for Saul, seeing I have rejected him from reigning over Israel? Fill your horn with oil, and go, I am sending you to Jesse the Bethlehemite. For _____ a king among his sons.'" 1 SAMUEL 16:1

TRUE OR FALSE:

2. "So Samuel did what the LORD said, and went to Bethlehem." 1 SAMUEL 16:4
TRUE OR FALSE

FILL IN THE BLANKS:

3. "Then he _____ Jesse and his sons, and invited them to the sacrifice." 1 SAMUEL 16:5
4. "Thus Jesse made seven of his sons pass before Samuel. And Samuel said to Jesse, 'The _____ has not chosen one of these.'" 1 SAMUEL 16:10
5. "And Samuel said to Jesse, 'Are all the young men here?' Then he said, 'There remains yet the _____, and there he is, keeping the sheep.'" 1 SAMUEL 16:11

UNDERLINE THE CORRECT ANSWER:

6. "So he sent and brought him in. Now he was..." 1 SAMUEL 16:12
- a. ruddy
 - b. with bright eyes
 - c. good-looking
 - d. all of the above

TRUE OR FALSE:

7. "And the LORD said, 'Arise, anoint him, for this is the one!'" 1 SAMUEL 16:12
TRUE OR FALSE

FILL IN THE BLANK:

8. "Then Samuel took the horn of oil and anointed him in the midst of his brothers; and the Spirit of the LORD came upon _____ from that day forward." 1 SAMUEL 16:13

78. DAVID IS ANOINTED KING BY SAMUEL (1 SAMUEL 16:1-13)

B J K O B L J P T O T N G G Q I P R M C
 T C N L J Q B D T L H C A N L N U N B A
 I T Z O J S A Q J M H Q L I K O R S O B
 T U Y B G Z O N G S E C L K Q S P A M N
 L N I Z J G J A O T L H V O I E A G C B
 K Y W Z V I R F A I Z J E O J J T U A I
 W T Z V S K O A Z R N Y C L G L Y U L B
 Q F L X N A Z H T X R T B A H B W W C G
 I U M D H W N D U Z L C P O P T Y O B A
 E Y O O A B G C J L P T N H C N E W X H
 Q Z B A E V E W T U E G L G Q Z D B N Q
 G M D O A N I Y Q I J U H Z I Z S T I Q
 A M R H T K C D K T F U M B Y Q T H M Y
 D H C P T R A E H W Z I O A R X T J Q C
 B W B W E C J F K E Z X E O S X W E F L
 D V R N D H X Z V C U B C D O P N S U V
 L V N R Y O U N G E S T G B I G G S N P
 V N O K H P P W H U P T S V T D F E Q O
 G L V Y D U D G S C F G M D E T O Z G B
 L C N N I M J Z T J Q M E H H M B N T I

ANOINT
 BETHLEHEM
 DAVID
 SAMUEL

HEART
 JESSE
 LORD
 KING

SANCTIFIED
 SAUL
 YOUNGEST

WRITE DOWN THE LETTERS AS YOU COME TO THEM ON THE LINES BELOW

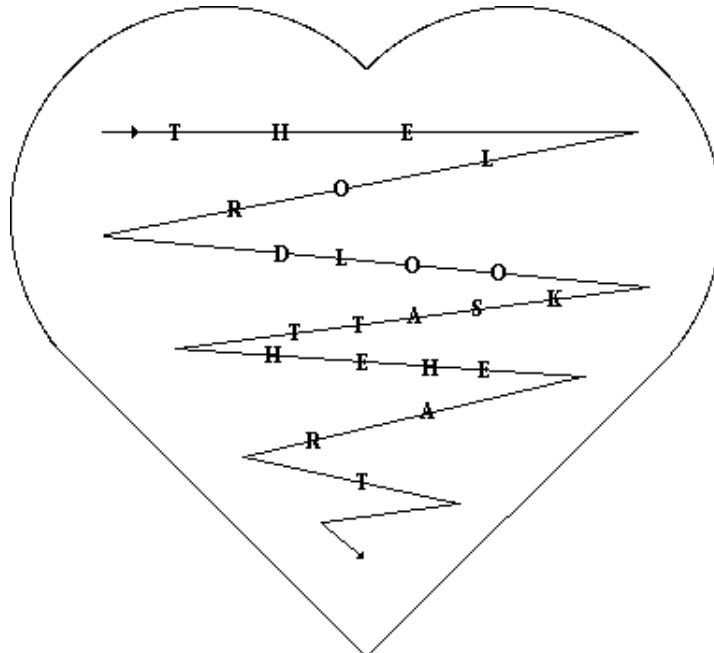

78. DAVID IS ANOINTED KING BY SAMUEL

(1 SAMUEL 16:1-13)

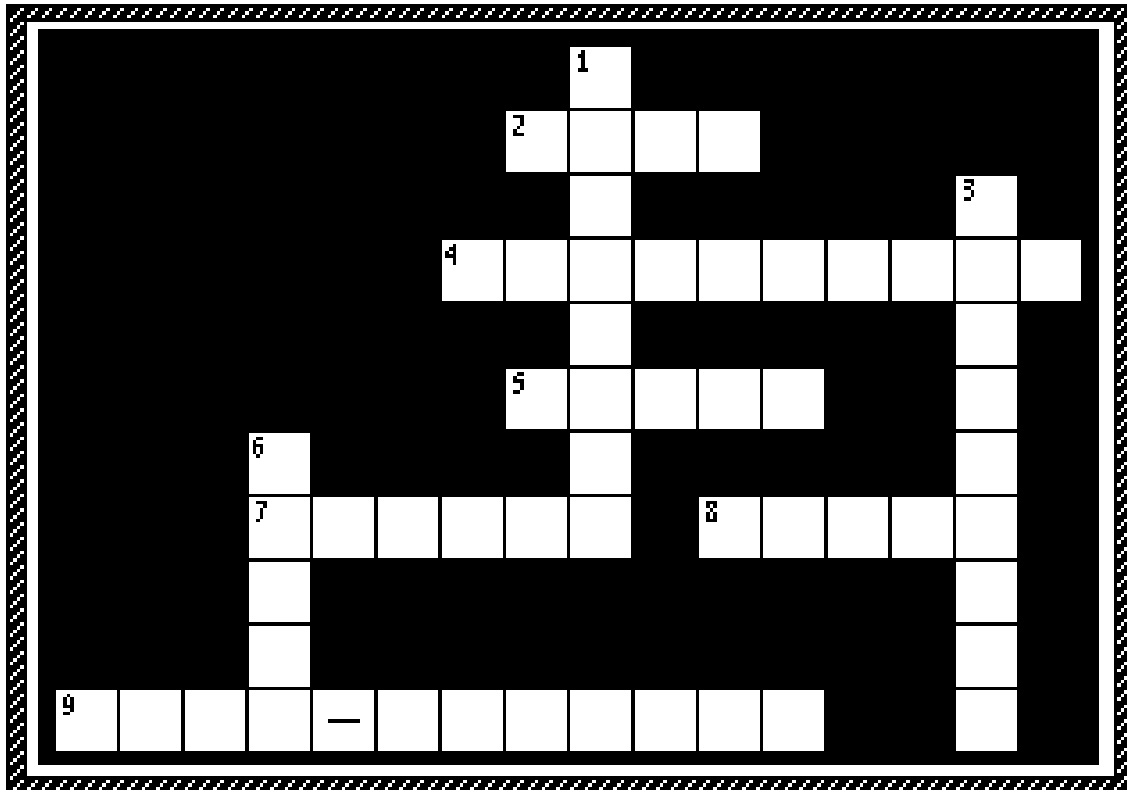

- 8 ACROSS "Now the LORD said to Samuel, 'How long will you mourn for Saul, seeing I have rejected him from reigning over Israel? Fill your horn with oil, and go, I am sending you to _____ the Bethlehemite.'" **1 SAMUEL 16:1**
- 3 DOWN "So Samuel did what the LORD said, and went to _____." **1 SAMUEL 16:4**
- 4 ACROSS "Then he _____ Jesse and his sons, and invited them to the sacrifice." **1 SAMUEL 16:5**
- 5 ACROSS "For the LORD does not see as man sees; for man looks at the outward appearance, but the LORD looks at the _____." **1 SAMUEL 16:7**
- 2 ACROSS "Thus Jesse made seven of his sons pass before Samuel. And Samuel said to Jesse, 'The _____ has not chosen one of these.'" **1 SAMUEL 16:10**
- 1 DOWN "And Samuel said to Jesse, 'Are all the young men here?' Then he said, 'There remains yet the _____, and there he is, keeping the sheep.'" **1 SAMUEL 16:11**
- 9 ACROSS "So he sent and brought him in. Now he was ruddy, with bright eyes, and _____." **1 SAMUEL 16:12**
- 7 ACROSS "And the LORD said, 'Arise, _____ him, for this is the one!'" **1 SAMUEL 16:12**
- 6 DOWN "Then Samuel took the horn of oil and anointed him in the midst of his brothers; and the Spirit of the LORD came upon _____ from that day forward." **1 SAMUEL 16:13**

Bible Story 79

DAVID & GOLIATH

1 SAMUEL 17:1-52

79. DAVID & GOLIATH

(1 SAMUEL 17:1-52)



"Then said David to the Philistine, Thou comest to me with a sword, and with a spear, and with a shield: but I come to thee in the name of the LORD of hosts, the God of the armies of Israel, whom thou hast defied."

1 SAMUEL 17:45

79. DAVID & GOLIATH

(1 SAMUEL 17:1-52)

V A L L E Y A S N G J G T S N
F O Q D L J T O T G A I T A H
G I O N B D N S R A H K M U J
I H T A I L O G E L F E G L L
E L V K R U B H M N O F A V D
G D Y A P V K Y I F O R F W I
E S M U O H L Q T Y M T I A A
L P C W W C I H F O N F S T R
T J J K D G E L R T Y T L Z F
T L N I H L S K I P W E Y V A
A J V Y O O L G J S A S M K M
B A B R J Q I O Q R T T R B B
D T D Y S A N J S V C I A M K
W B L E R E G I E E N O N S N
K V L H V G D M P N R Y U E P

AFRAID

ISRAEL

SLING

ARMOR

NAME OF THE LORD

STAFF

BATTLE

PHILISTINE

STONES

DAVID

SAUL

VALLEY

GOLIATH

79. DAVID & GOLIATH

(1 SAMUEL 17:1-52)

MEMORY VERSE:

"The LORD does not save with sword and spear; for the battle is the LORD'S, and He will give you into our hands." 1 SAMUEL 17:47

FILL IN THE BLANKS:

1. "The Philistines stood on a mountain on one side, and Israel stood on a mountain on the other side, with a _____ between them." 1 SAMUEL 17:3
2. "And a champion went out from the camp of the Philistines, named _____, from Gath, whose height was six cubits and a span." 1 SAMUEL 17:4

TRUE OR FALSE:

3. "And the Philistine said, 'I defy the armies of Israel this day; give me a man, that we may fight together.'" 1 SAMUEL 17:10
TRUE OR FALSE
4. When Saul and all Israel heard these words of the Philistine, they were happy and greatly excited. 1 SAMUEL 17:11
TRUE OR FALSE
5. "Then David said to Saul, 'Let no man's heart fail because of him; your servant will go and fight with this Philistine.'" 1 SAMUEL 17:32
TRUE OR FALSE
6. "Saul clothed David with his armor, and he put a bronze helmet on his head; he also clothed him with a coat of mail." 1 SAMUEL 17:38
TRUE OR FALSE
7. The armor fit perfectly and David wore them into battle. 1 SAMUEL 17:39
TRUE OR FALSE

FILL IN THE BLANKS:

8. "Then he took his _____ in his hand; and he chose for himself five smooth _____ from the brook, and put them in a shepherd's bag, in a pouch which he had, and his sling was in his hand." 1 SAMUEL 17:40
9. "So the Philistine said to David, 'Am I a _____, that you come to me with sticks?' " 1 SAMUEL 17:43
10. "Then David said to the Philistine, 'You come to me with a _____, with a _____, and with a _____. But I come to you in the name of the LORD of hosts, the God of the armies of Israel, whom you have defied.'" 1 SAMUEL 17:45

CIRCLE THE CORRECT WORDS:

11. "David put his hand in his bag and took out a stone; and he slung it and (**STRUCK, MISSED**) the Philistine in his forehead." 1 SAMUEL 17:49
12. "So David (**FAILED, PREVAILED**) over the Philistine with a sling and a stone, and struck the Philistine and killed him." 1 SAMUEL 17:50

79. DAVID & GOLIATH

(1 SAMUEL 17:1-52)

H H Z L F B D L U Y H D A Y M X Q V K T
D S P S A F D N U B X I G K G M C T S L
T E Q T L Q A L R O K P H E D G R L N Z
N Q T V S J V T J J K M G O O Q H M U T
Y L L P N H V Z S C S W N H T A I L O G
E M A Z P A D D Z V L A W J T O N G P T
B B L S M L K S R G D I U S C T N H W Y
P M L M N E P V F O S L B L U I I M S S
N C M B Q F S M J R L G W Z L L N G C M
U B S A Q O H O A W O E B S I H V K T H
L B O K H Y P E F H F S H S V K G M P V
N Y A I V E L N E H L D T T N W R P M Y
Z U L Y Z L P G O B Q I A N F A K D S H
H W K T U L R I R Y N Z V V R O I E D L
R D N S D A B C I E R R B M I A E I Q M
A O M F T V N N Y B K O O W R D Z M H E
A K G Z F O G E S U D R H F V W L P A J
J J G B H V N B Y L R J A I M C C L E N
Y Q T C G Q B E D Y H L C O U L I E N L
G D E S U D L P S L L L O V O R V P P D

AFRAID

ISRAEL

SLING

ARMOR

NAME OF THE LORD

STAFF

BATTLE

PHILISTINE

STONES

DAVID

VALLEY OF ELAH

SAUL

GOLIATH

79. DAVID & GOLIATH

(1 SAMUEL 17:1-52)

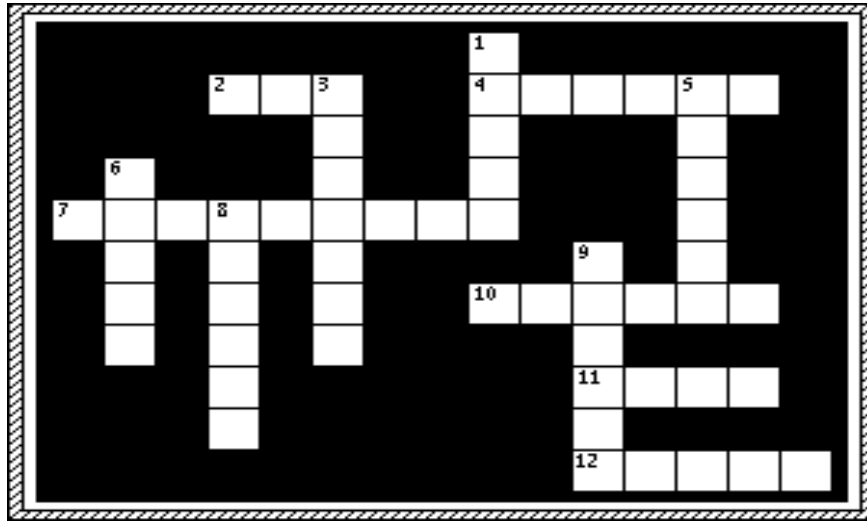

- 8 DOWN "The Philistines stood on a mountain on one side, and Israel stood on a mountain on the other side, with a _____ between them." **1 SAMUEL 17:3**
- 3 DOWN "And a champion went out from the camp of the Philistines, named _____, from Gath, whose height was six cubits and a span." **1 SAMUEL 17:4**
- 5 DOWN "And the Philistine said, 'I defy the armies of _____ this day; give me a man, that we may fight together.'" **1 SAMUEL 17:10**
- 4 ACROSS "When Saul and all Israel heard these words of the Philistine, they were dismayed and greatly _____." **1 SAMUEL 17:11**
- 1 DOWN "Then _____ said to Saul, 'Let no man's heart fail because of him; your servant will go and fight with this Philistine.'" **1 SAMUEL 17:32**
- 6 DOWN "Saul clothed David with his _____, and he put a bronze helmet on his head; he also clothed him with a coat of mail." **1 SAMUEL 17:38**
- 9 DOWN "Then he took his staff in his hand; and he chose for himself five smooth _____ from the brook, and put them in a shepherd's bag." **1 SAMUEL 17:40**
- 2 ACROSS "The Philistine said to David, 'Am I a _____, that you come to me with sticks?'" **1 SAMUEL 17:43**
- 11 ACROSS David said to the Philistine, "I come to you in the _____ of the LORD of hosts, the God of the armies of Israel, whom you have defied." **1 SAMUEL 17:45**
- 10 ACROSS "The LORD does not save with sword and spear; for the _____ is the LORD'S, and He will give you into our hands." **1 SAMUEL 17:47**
- 12 ACROSS "David put his hand in his bag and took out a stone; and he _____ it and struck the Philistine in his forehead." **1 SAMUEL 17:49**
- 7 ACROSS "So David _____ over the Philistine with a sling and a stone, and struck the Philistine and killed him." **1 SAMUEL 17:50**

Bible Story 80

**THE FRIENDSHIP
OF
DAVID & JONATHAN**

1 SAMUEL 20

80. THE FRIENDSHIP OF DAVID AND JONATHAN

(1 SAMUEL 20)



"May the LORD be between you and me, and between your descendants and my descendants forever."
1 SAMUEL 20:42

80. THE FRIENDSHIP OF DAVID AND JONATHAN

(1 SAMUEL 20)

MEMORY VERSE:

"May the LORD be between you and me, and between your descendants and my descendants forever." 1 SAMUEL 20:42

TRUE OR FALSE:

1. "David fled from Naioth in Ramah, and went and said to Jonathan, 'What have I done? What is my iniquity, and what is my sin before your father, that he seeks my life?'" **1 SAMUEL 20:1**
TRUE OR FALSE
2. "And David said to Jonathan, 'Indeed tomorrow is the New Moon, and I should not fail to sit with the king to eat. But let me go, that I may hide in the field until the third day at evening.'" **1 SAMUEL 20:5**
TRUE OR FALSE
3. "If your father misses me at all, then say, 'David earnestly asked permission of me that he might run over to Jerusalem, his city, for there is a yearly sacrifice there for all the family.'" **1 SAMUEL 20:6**
TRUE OR FALSE

CIRCLE THE CORRECT WORDS:

4. "If he says thus: 'It is well,' your servant will be safe. But if he is very (**HAPPY, ANGRY**), be sure that evil is determined by him." **1 SAMUEL 20:7**
5. "If it pleases my father to do you evil, then I will report it to you and send you away, that you may go in (**SAFETY, ANGER**). And the LORD be with you as He has been with my father." **1 SAMUEL 20:13**

TRUE OR FALSE:

6. Jonathan would not cause David to vow, because he did not like David. **1 SAMUEL 20:17**
TRUE OR FALSE

FILL IN THE BLANKS:

7. "Then Jonathan said to David, 'Tomorrow is the New Moon; and you will be missed, because your seat will be _____. And when you have stayed three days, go down quickly and come to the place where you hid on the day of the deed; and remain by the _____ Ezel.'" **1 SAMUEL 20:18-19**

CIRCLE THE CORRECT WORDS:

8. Jonathan said, "I will shoot three (**DARTS, ARROWS**) to the side of it, as though I shot at a target; and there I will send a lad." **1 SAMUEL 20:20-21**
9. Then Jonathan said, "If I expressly say to him, 'Look, the arrows are on this side of you; get them and come' - then, as the LORD lives, there is (**SAFETY, DANGER**) for you and no harm. But if I say thus to the young man, 'Look, the arrows are beyond you' - go your way, for the (**KING, LORD**) has sent you away." **1 SAMUEL 20:21-22**
10. When it was clear that Saul was indeed after David, "Jonathan said to David, 'Go in (**FEAR, PEACE**), since we have both sworn in the name of the LORD, saying, "May the LORD be between you and me, and between your descendants and my descendants forever." ' " **1 SAMUEL 20:42**

80. THE FRIENDSHIP OF DAVID AND JONATHAN (1 SAMUEL 20)

K Y W V M Q Y U W K I U S N W
 S W H L D L J O N A T H A N P
 P D U P O E J T Q O U T M A N
 P A L V E J S N M B D I V A D
 S E E E Q R T S I H A T J Y K
 R D Q C I I M D I F F D T Q B
 V L I L S F S I T M F D A U C
 O V L A O C N W S N T Q A Q D
 S S H L Q R A R O S R C U T W
 L D A O V T D A A R I O E H K
 K D T F S C S Z L V R O W T I
 W Z Y Z E E L E B I Q A N S E
 V Z O M P T A M Z O H U N T P
 A N G R Y J Y T Z N A J Q R I
 J O A F B W P D N H U K X R Y

ANGRY
 ARROWS
 DAVID
 FIELD
 JONATHAN

LORD
 LOVED
 MISSED
 PERMISSION

SAFETY
 SAUL
 SEAT
 SWORN

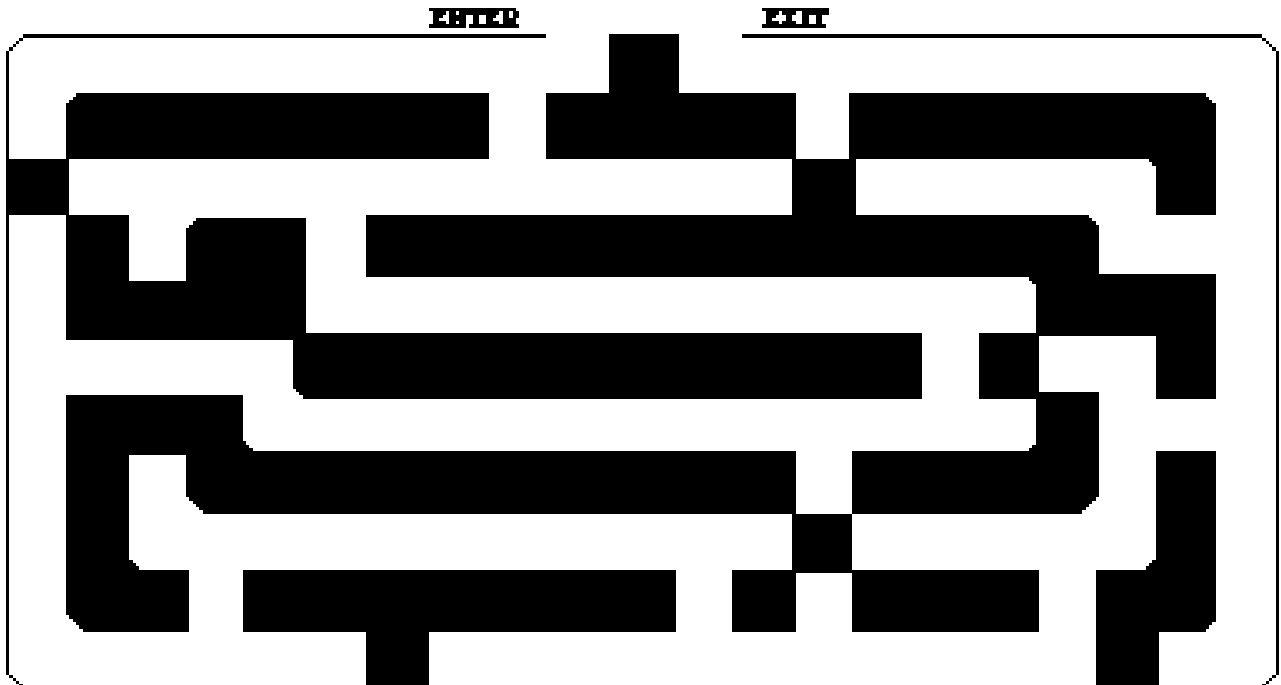

80. THE FRIENDSHIP OF DAVID AND JONATHAN

(1 SAMUEL 20)

MEMORY VERSE:

"May the LORD be between you and me, and between your descendants and my descendants forever." 1 SAMUEL 20:42

TRUE OR FALSE:

1. "David fled from Naioth in Ramah, and went and said to Jonathan, 'What have I done? What is my iniquity, and what is my sin before your father, that he seeks my life?' " **1 SAMUEL 20:1**
TRUE OR FALSE
2. "And David said to Jonathan, 'Indeed tomorrow is the New Moon, and I should not fail to sit with the king to eat. But let me go, that I may hide in the field until the third day at evening.' " **1 SAMUEL 20:5**
TRUE OR FALSE

FILL IN THE BLANKS:

3. "If your father misses me at all, then say, 'David earnestly asked permission of me that he might run over to _____, his city, for there is a yearly sacrifice there for all the family.' " **1 SAMUEL 20:6**
4. "If he says thus: 'It is well,' your servant will be safe. But if he is very _____, be sure that evil is determined by him." **1 SAMUEL 20:7**
5. "If it pleases my father to do you evil, then I will report it to you and send you away, that you may go in _____. And the LORD be with you as He has been with my father." **1 SAMUEL 20:13**

TRUE OR FALSE:

6. Jonathan would not cause David to vow, because he did not like David. **1 SAMUEL 20:17**
TRUE OR FALSE

FILL IN THE BLANKS:

7. "Then Jonathan said to David, 'Tomorrow is the New Moon; and you will be missed, because your seat will be _____. And when you have stayed three days, go down quickly and come to the place where you hid on the day of the deed; and remain by the _____ Ezel.' " **1 SAMUEL 20:18-19**
8. Jonathan said, "I will shoot three _____ to the side of it, as though I shot at a target; and there I will send a lad." **1 SAMUEL 20:20-21**
9. Then Jonathan said, "If I expressly say to him, 'Look, the arrows are on this side of you; get them and come' - then, as the LORD lives, there is _____ for you and no harm. But if I say thus to the young man, 'Look, the arrows are beyond you' - go your way, for the _____ has sent you away." **1 SAMUEL 20:21-22**
10. When it was clear that Saul was indeed after David, "Jonathan said to David, 'Go in _____, since we have both sworn in the name of the LORD, saying, "May the LORD be between you and me, and between your descendants and my descendants forever." ' " **1 SAMUEL 20:42**

80. THE FRIENDSHIP OF DAVID AND JONATHAN

(1 SAMUEL 20)

D M D H H B C Z J O J U H N R X T H N A
 L M R N E N J W Q W Z M O O O P W Z I H
 T H C W A K X G K E Z B C I I G N N M Q
 A W B X T C P Z K C U T G S T S G M Q Q
 E V R K E H D M I S S E D S E D W B F Y
 S V N Y H P J T V U P A S I H T F O L C
 V N V N J U P T H C V G M M I M O O R L
 G C N B D O D J S I F M E R T P B M N N
 L K O A I M N G D J Q G Z E O L O R D V
 J N L J N J Q A T S N A B P E U R C Q X
 C Z O J L G A A T T W L O E C A E P G O
 T Y B G Q B R Z O H B O B I J R N A T B
 U I Z S S O F Y L H A L R J L P S C C I
 N W Z A Z J A L S H Q N V R B T A F A B
 Y Z V U G R H O T L C V D G A B J I B N
 T L X L M O D V R Z J C H P N W U E N A
 F M O R S A F E T Y Y B Q C Z Y W L B S
 U O A J I Z W D X R C X B Q Z D O D I M
 Y H A V K G Y T Z L T N K I Q S W B B U
 Z B O N W E F W W P G F Q Y M T T R G Z

ANGRY
 ARROWS
 DAVID
 FIELD
 HARM

JONATHAN
 LORD
 LOVED
 MISSED
 PEACE

PERMISSION
 SAFETY
 SAUL
 SEAT
 SWORN

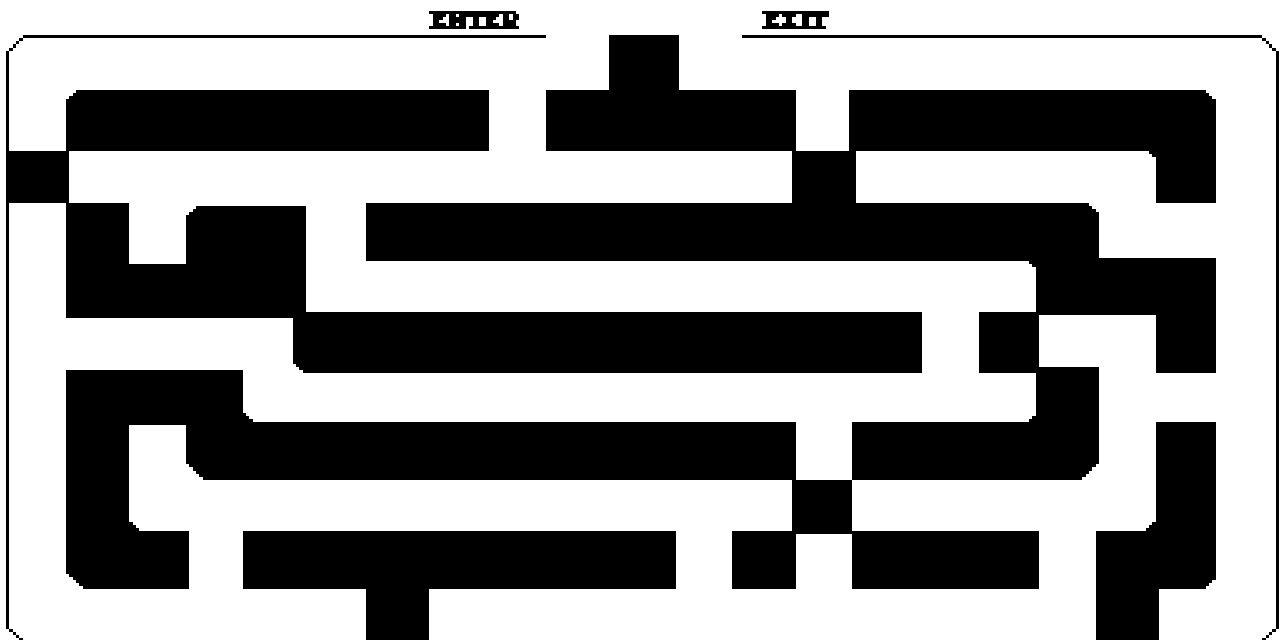

80. THE FRIENDSHIP OF DAVID AND JONATHAN

(1 SAMUEL 20)

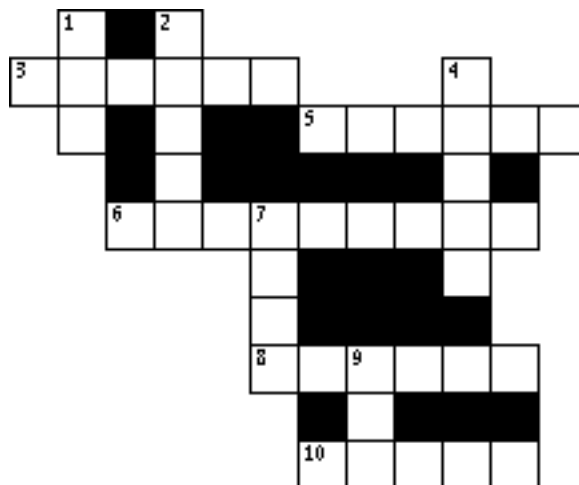

- 9 DOWN "David fled from Naioth in Ramah, and went and said to Jonathan, 'What have I done? What is my iniquity, and what is my _____ before your father, that he seeks my life?' " **1 SAMUEL 20:1**
- 1 DOWN "And David said to Jonathan, 'Indeed tomorrow is the New Moon, and I should not fail to sit with the king to _____.'" **1 SAMUEL 20:5**
- 6 ACROSS "If your father misses me at all, then say, 'David earnestly asked permission of me that he might run over to _____, his city, for there is a yearly sacrifice there for all the family.'" **1 SAMUEL 20:6**
- 10 ACROSS "If he says thus: 'It is well,' your servant will be safe. But if he is very _____, be sure that evil is determined by him." **1 SAMUEL 20:7**
- 3 ACROSS "If it pleases my father to do you evil, then I will report it to you and send you away, that you may go in _____. And the LORD be with you as He has been with my father." **1 SAM. 20:13**
- 4 DOWN "Jonathan again caused David to vow, because he _____him; for he loved him as he loved his own soul." **1 SAMUEL 20:17**
- 8 ACROSS "Then Jonathan said to David, 'Tomorrow is the New Moon; and you will be missed, because your seat will be _____.'" **1 SAMUEL 20:18**
- 5 ACROSS Jonathan said, "I will shoot three _____ to the side of it, as though I shot at a target; and there I will send a lad." **1 SAMUEL 20:20-21**
- 7 DOWN Then Jonathan said, "If I expressly say to him, 'Look, the arrows are on this side of you; get them and come' - then, as the LORD lives, there is safety for you and no _____." **1 SAMUEL 20:21**
- 2 DOWN "Jonathan said to David, 'Go in _____.'" **1 SAMUEL 20:42**

Bible Story 81

**DAVID SPARES
SAUL'S LIFE
(TWICE)**

1 SAMUEL 23:14-24:22; 26

81. DAVID SPARES SAUL'S LIFE (TWICE)

(1 SAMUEL 23:14-24:22; 26)



"And the men of David said unto him, Behold the day of which the LORD said unto thee, Behold, I will deliver thine enemy into thine hand, that thou mayest do to him as it shall seem good unto thee. Then David arose, and cut off the skirt of Saul's robe privily."

1 SAMUEL 24:4

81. DAVID SPARES SAUL'S LIFE (TWICE)

(1 SAMUEL 23:14-24:22; 26)

MEMORY VERSE:

"The LORD delivered you into my hand today, but I would not stretch out my hand against the LORD'S anointed." 1 SAMUEL 26:23

TRUE OR FALSE:

1. Saul sought David every day, and God finally delivered him into his hand. 1 SAMUEL 23:14
TRUE OR FALSE

CIRCLE THE CORRECT WORDS:

2. "So David saw that Saul had come out to seek his life. And David was in the Wilderness of Ziph in a (DESERT, FOREST)." 1 SAMUEL 23:15
3. "When Saul and his men went to seek him, they told David. Therefore he went down to the rock, and stayed in the Wilderness of Maon. And when Saul heard that, he (PURSUED, LEFT) David in the Wilderness of Maon." 1 SAMUEL 23:25
4. "A messenger came to Saul, saying 'Hurry and come, for the Philistines have (BURNED, INVADED) the land!' Therefore Saul returned from pursuing David, and went against the Philistines." 1 SAMUEL 23:27

TRUE OR FALSE:

5. "Now it happened, when Saul had returned from following the Philistines, that it was told him, saying, 'Take note! David is in the Wilderness of En Gedi.'" 1 SAMUEL 24:1
TRUE OR FALSE
6. Saul came to the sheepfolds by the road, where there was a cave; but Saul would not go into the cave. 1 SAMUEL 24:3
TRUE OR FALSE
7. "Then the men of David said to him, 'This is the day of which the LORD said to you, 'Behold, I will deliver your enemy into your hand, that you may do to him as it seems good to you.' And David arose and secretly cut off a corner of Saul's robe.'" 1 SAMUEL 24:4
TRUE OR FALSE

CIRCLE THE CORRECT WORDS:

8. David called out to Saul, "Look, this day your eyes have seen that (THE LORD, MEN) delivered you today into my hand in the cave, and someone urged me to kill you. But my eye spared you, and I said, 'I will not stretch out my hand against my lord, for he is the LORD'S anointed.'" 1 SAM 24:10
9. "Then he said to David: 'You are more righteous than I; for you have rewarded me with good, whereas I have rewarded you with (GOOD, EVIL).'" 1 SAMUEL 24:17
10. Again "Saul arose and went down to the Wilderness of Ziph, having three thousand chosen men of Israel with him to (SEEK, WELCOME) David in the Wilderness of Ziph." 1 SAMUEL 26:2
11. "David and Abishai came to the people by night; and there Saul lay (EATING, SLEEPING) within the camp, with his spear stuck in the ground by his head." 1 SAMUEL 26:7
12. David said, "Take now the spear and the jug of water that are by his (HEAD, FEET) and let us go." 1 SAMUEL 26:11
13. "Saul said, 'I will harm you no more, because my life was precious in your eyes this day. Indeed I have played the (FOOL, FLUTE) and erred exceedingly.'" 1 SAMUEL 26:21

81. DAVID SPARES SAUL'S LIFE

(1 SAMUEL 23:14-24:22; 26)

J N M Z B Z L L C C E E Y S L
G U L I D U E V I L M M Q T F
E L G U V G A W V B H V D V L
W Y E I A G N I P E E L S G K
G I T D D S F C L F Y T O W I
F B D Z S E O A I O Y O O D Q
Z L E P N P R Z P O M J A K S
A O D Z P F E E N L B N K A S
N U A V Y Y S A V C O Q D G O
S P V U G I T S R I P L I S E
H W N D I D E G N E L P V A Z
U C I W N F E T S J R E A U R
S P L C A V E D C G O O D K O
Y R M E W D Z G N P Y V P S B
J F E E Y B C P P R R G Z Y E

ANOINTED

EVIL

JUG

CAVE

FOOL

ROBE

DAVID

FOREST

SAUL

DELIVERED

GOOD

SLEEPING

EN GEDI

INVADED

SPEAR

81. DAVID SPARES SAUL'S LIFE (TWICE)

(1 SAMUEL 23:14-24:22; 26)

MEMORY VERSE:

"The LORD delivered you into my hand today, but I would not stretch out my hand against the LORD'S anointed." 1 SAMUEL 26:23

TRUE OR FALSE:

1. Saul sought David every day, and God finally delivered him into his hand. 1 SAMUEL 23:14
TRUE OR FALSE

FILL IN THE BLANKS:

2. "So David saw that Saul had come out to seek his life. And David was in the Wilderness of Ziph in a _____." 1 SAMUEL 23:15
3. "When Saul and his men went to seek him, they told David. Therefore he went down to the rock, and stayed in the Wilderness of Maon. And when Saul heard that, he _____ David in the Wilderness of Maon." 1 SAMUEL 23:25
4. "A messenger came to Saul, saying 'Hurry and come, for the Philistines have _____ the land!' Therefore Saul returned from pursuing David, and went against the Philistines." 1 SAMUEL 23:27

TRUE OR FALSE:

5. "Now it happened, when Saul had returned from following the Philistines, that it was told him, saying, 'Take note! David is in the Wilderness of En Gedi.'" 1 SAMUEL 24:1
TRUE OR FALSE
6. Saul came to the sheepfolds by the road, where there was a cave; but Saul would not go into the cave. 1 SAMUEL 24:3
TRUE OR FALSE
7. "Then the men of David said to him, 'This is the day of which the LORD said to you, 'Behold, I will deliver your enemy into your hand, that you may do to him as it seems good to you.' And David arose and secretly cut off a corner of Saul's robe." 1 SAMUEL 24:4
TRUE OR FALSE

FILL IN THE BLANKS:

8. David called out to Saul, "Look, this day your eyes have seen that _____ delivered you today into my hand in the cave, and someone urged me to kill you. But my eye spared you, and I said, 'I will not stretch out my hand against my lord, for he is the LORD'S anointed.'" 1 SAMUEL 24:10
9. "Then he said to David: 'You are more _____ than I; for you have rewarded me with good, whereas I have rewarded you with evil.'" 1 SAMUEL 24:17
10. Again "Saul arose and went down to the Wilderness of Ziph, having three thousand chosen men of Israel with him to _____ David in the Wilderness of Ziph." 1 SAMUEL 26:2
11. "David and Abishai came to the people by night; and there Saul lay _____ within the camp, with his spear stuck in the ground by his head." 1 SAMUEL 26:7
12. David said, "Take now the spear and the jug of water that are by his _____ and let us go." 1 SAMUEL 26:11
13. "Saul said, 'I will harm you no more, because my life was precious in your eyes this day. Indeed I have played the _____ and erred exceedingly.'" 1 SAMUEL 26:21

81. DAVID SPARES SAUL'S LIFE

(1 SAMUEL 23:14-24:22; 26)

C T Q J M Z V T M I K S Z J F J U A Y C
U E V A C F B B G W C T S H I P F O O L
Q A I F H H Q I F Z T G T G M N K C Y V
D U K F L N Y A H K I O H S G L C W O T
C U T O D G E M A K O O M E E D A V I D
R H D E D A V N I Q T D R U Y R U J J W
N O D P R M L N W J A F S W P O O U F H
W E B E E G N T L B N A V D Y F M F A P
T R Y E U G V Y P B R Y O R A E P S H J
S J H J U R Q L E R D Y J W B L D K A H
A S U O W Q T I S B P E J Y D L L O H Q
U D E T N I O N A K I O L P R M S I Z O
L T Q O J I A O G E Q F E I C S V T Y A
I A S C N P E V D F D V A Z V Z R E N W
W Z S F S N Q Q E J J H W W G E C J J V
P S I K G H F Z P T Q S L L R F R K T M
S L E E P I N G Z E R V I B G P M E P F
P D D B Z Z H U C J I V Z M N G L K D S
W I L Y K I P A C Z E M X W G K B P L W
Q J S N B V J N Q Z L A P U Z B X Z J U

ANOINTED

EVIL

JUG

CAVE

FOOL

ROBE

DAVID

FOREST

SAUL

DELIVERED

GOOD

SLEEPING

EN GEDI

INVADED

SPEAR

81. DAVID SPARES SAUL'S LIFE (TWICE)

(1 SAMUEL 23:14-24:22; 26)

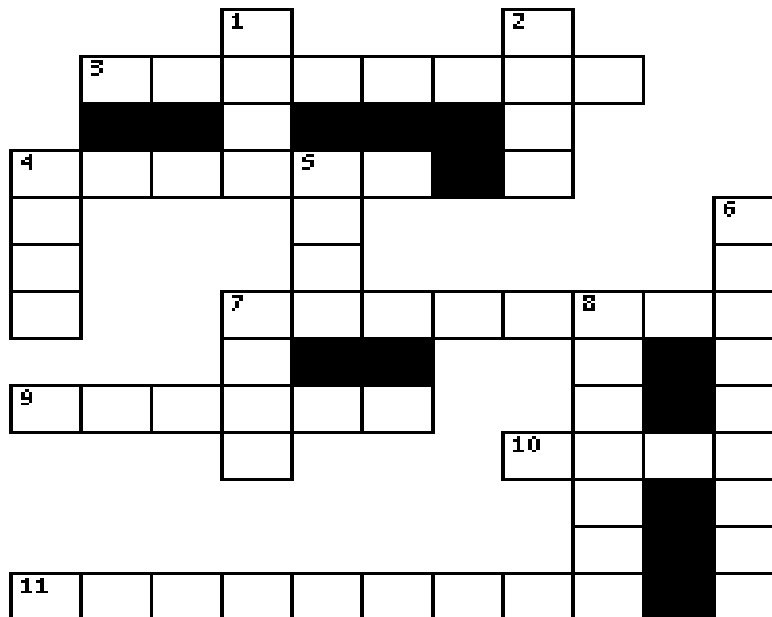

5 DOWN "_____ sought David every day, but God did not deliver him into his hand." **1 SAMUEL 23:14**

4 ACROSS "David was in the Wilderness of Ziph in a _____." **1 SAMUEL 23:15**

8 DOWN "A messenger came to Saul, saying 'Hurry and come, for the Philistines have _____ the land!' " **1 SAMUEL 23:27**

9 ACROSS "Now it happened, when Saul had returned from following the Philistines, that it was told him, saying, 'Take note! David is in the Wilderness of _____.'" **1 SAMUEL 24:1**

10 ACROSS "Saul came to the sheepfolds by the road, where there was a _____." **1 SAMUEL 24:3**

1 DOWN "David arose and secretly cut off a corner of Saul's _____." **1 SAMUEL 24:4**

11 ACROSS David called out to Saul, "Look, this day your eyes have seen that the LORD _____ you today into my hand in the cave, and someone urged me to kill you." **1 SAMUEL 24:10**

6 DOWN "Then he said to David: 'You are more _____ than I; for you have rewarded me with good, whereas I have rewarded you with evil.' " **1 SAMUEL 24:17**

7 DOWN Again "Saul arose and went down to the Wilderness of Ziph, having three thousand chosen men of Israel with him to _____ David in the Wilderness of Ziph." **1 SAMUEL 26:2**

7 ACROSS "David and Abishai came to the people by night; and there Saul lay _____ within the camp, with his spear stuck in the ground by his head." **1 SAMUEL 26:7**

2 DOWN "Take now the spear and the jug of water that are by his _____ and let us go." **1 SAMUEL 26:11**

4 DOWN "Saul said, 'Indeed I have played the _____ and erred exceedingly.' " **1 SAMUEL 26:21**

3 ACROSS "The LORD delivered you into my hand today, but I would not stretch out my hand against the LORD'S _____" **1 SAMUEL 26:23**

Bible Story 82

**SAUL & HIS SONS
DIE IN BATTLE**

1 SAMUEL 31

82. SAUL AND HIS SONS DIE IN BATTLE

(1 SAMUEL 31)



"Then the Philistines fought against Israel; and the men of Israel fled before the Philistines, and fell slain on Mount Gilboa."

1 SAMUEL 31:1

82. SAUL AND HIS SONS DIE IN BATTLE

(1 SAMUEL 31)

MEMORY VERSE:

"Because you have rejected the word of the LORD, He has also rejected you from being king." 1 SAMUEL 15:23

CIRCLE THE CORRECT WORDS:

1. "The Philistines fought against Israel; and the men of Israel (**READ, FLED**) before the Philistines, and fell slain on Mount Gilboa." 1 SAMUEL 31:1
2. "Then the Philistines followed hard after Saul and his sons. And the Philistines (**KILLED, HELPED**) Jonathan, Abinadab, and Malchishua, Saul's sons." 1 SAMUEL 31:2
3. "The battle became fierce against Saul. The archers hit him and he was severely wounded by the (**ARCHERS, SWORD**)." 1 SAMUEL 31:3

TRUE OR FALSE:

4. "Then Saul said to his armorbearer, 'Draw your sword, and thrust me through with it, lest these uncircumcised men come and thrust me through and abuse me.'" 1 SAMUEL 31:4
TRUE OR FALSE
5. So his armorbearer did that which Saul had asked of him. 1 SAMUEL 31:4
TRUE OR FALSE
6. "And when the men of Israel who were on the other side of the valley, and those who were on the other side of the Jordan, saw that the men of Israel had fled and that Saul and his sons were dead, they forsook the cities and fled; and the Philistines came and dwelt in them." 1 SAMUEL 31:7
TRUE OR FALSE

FILL IN THE BLANK:

7. "When the inhabitants of Jabesh Gilead heard what the _____ had done to Saul, all the valiant men arose and traveled all night." 1 SAMUEL 31:11

TRUE OR FALSE:

8. They "took the body of Saul and the bodies of his sons from the wall of Beth Shan." 1 SAMUEL 31:12
TRUE OR FALSE

FILL IN THE BLANK:

9. "Then they took their bones and buried them under the tamarisk tree at Jabesh, and _____ seven days." 1 SAMUEL 31:13

82. SAUL AND HIS SONS DIE IN BATTLE

(1 SAMUEL 31)

R S D T Z P J L M N I U S L T
V L D Y S F W P D K U T M N R
N D Z A A E Y U W O A T J A R
G K I S R B N T Q B S E N O B
D W T A M M J I M H F D T Y W
P E Z O R Q O N T F F D A Q P
D V O S F F D R I S T Q A U N
K J W A O J A E B D I M U Q K
S A H V M N T D T E R L E T B
P N R C Q I S R T C A O I H C
P W Q C S C N A A V E R W H D
R E I A H A A Z L I Q J E S P
N L L L S E U E B O H U E R W
F L E D Q T R L Z N A J N R K
O V H O V C S S Z H U K Q T I

AFRAID

FASTED

SAUL

ARCHERS

FLED

SONS

ARMORBEARER

PHILISTINES

SWORD

BONES

REJECTED

82. SAUL AND HIS SONS DIE IN BATTLE

(1 SAMUEL 31)

MEMORY VERSE:

"Because you have rejected the word of the LORD, He has also rejected you from being king." 1 SAMUEL 15:23

FILL IN THE BLANKS:

1. "The Philistines fought against Israel; and the men of Israel _____ before the Philistines, and fell _____ on Mount Gilboa." 1 SAMUEL 31:1
2. "Then the Philistines followed hard after Saul and his sons. And the Philistines _____ Jonathan, Abinadab, and Malchishua, Saul's sons." 1 SAMUEL 31:2
3. "The battle became fierce against Saul. The archers hit him and he was severely wounded by the _____." 1 SAMUEL 31:3
4. "Then Saul said to his armorbearer, 'Draw your _____, and thrust me through with it, lest these uncircumcised men come and thrust me through and abuse me.'" 1 SAMUEL 31:4

TRUE OR FALSE:

5. So his armorbearer did that which Saul had asked of him. 1 SAMUEL 31:4
TRUE OR FALSE

UNDERLINE THE CORRECT ANSWER:

6. "And when the men of Israel who were on the other side of the valley, and those who were on the other side of the Jordan, saw that the men of Israel had fled and that Saul and his sons were dead..." 1 SAMUEL 31:7
 - a. they forsook the cities and fled
 - b. the Philistines came and dwelt in them
 - c. all of the above
 - d. none of the above

FILL IN THE BLANK:

7. "When the inhabitants of Jabesh Gilead heard what the _____ had done to Saul, all the valiant men arose and traveled all night." 1 SAMUEL 31:11

TRUE OR FALSE:

8. They "took the body of Saul and the bodies of his sons from the wall of Beth Shan." 1 SAMUEL 31:12
TRUE OR FALSE

FILL IN THE BLANK:

9. "Then they took their bones and buried them under the tamarisk tree at Jabesh, and _____ seven days." 1 SAMUEL 31:13

82. SAUL AND HIS SONS DIE IN BATTLE

(1 SAMUEL 31)

H P D S M F Q A H Z Z L A J I N G A J P
K D R O W S Y M A K K S Z H X W K M F J
N W J J H H E R W K C S D G G O B W A H
C Q Q F L N L T M Q T O S I Y F V J H Q
U T I F D G N Y P J I N H E A L R J A O
B A D E T C E J E R O S M U P R T P H A
Q O K O R M V L E B T T V W Y L F O Z W
D U N P E G Q I S B A F S D B M U A Y V
C B T E U R T O G R N A V D E T S A F M
F H D E S Q A V D B R Y O W D S M I N F
L E Y O W I Q Q E K P Y J Y R Z D T J S
E R E R A E B R O M R A J P C S L E T W
D R H O J P F Z P E I O E Z G R S J P U
N J M C N H H N Z F Q F A W R E V K L D
W S Q F S Z P A C J D V W B G H R K J S
T T S K Z I J N C T J L L L N C C P C J
P H I L I S T I N E S S U M G R M Z V H
I A S B K V T M Q E R A Z W Z A L Y T Q
W Z I Y B V B G I J S V M U J F B Y W O
P S L N Z B I F W Z I M P F P P P O H E

AFRAID

FASTED

SAUL

ARCHERS

FLED

SONS

ARMORBEARER

PHILISTINES

SWORD

BONES

REJECTED

82. SAUL AND HIS SONS DIE IN BATTLE

(1 SAMUEL 31)

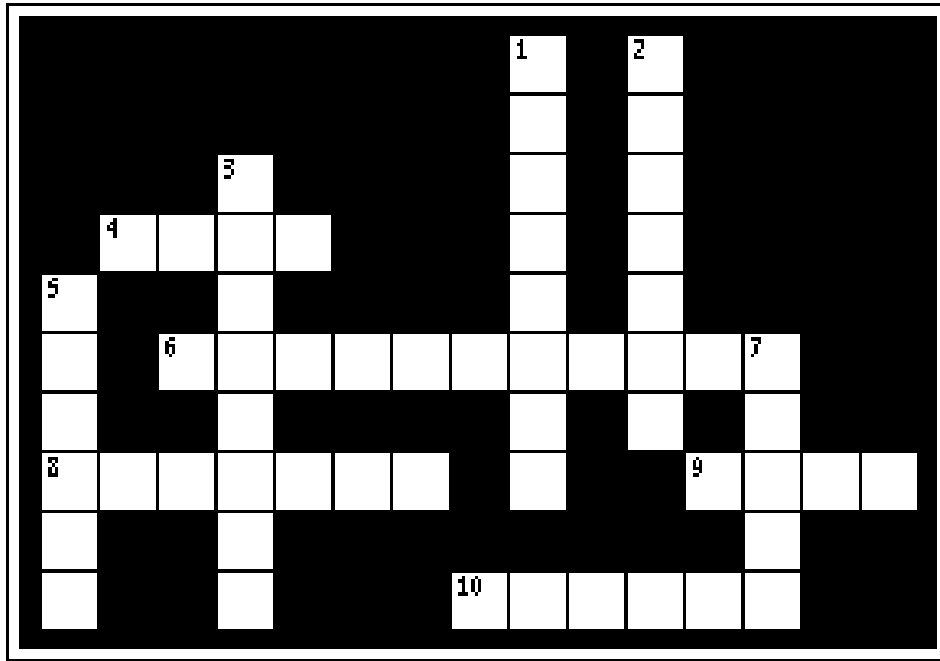

- 1 DOWN "Because you have rejected the word of the LORD, He has also _____ you from being king." **1 SAMUEL 15:23**
- 4 ACROSS "The Philistines fought against Israel; and the men of Israel _____ before the Philistines, and fell slain on Mount Gilboa." **1 SAMUEL 31:1**
- 9 ACROSS "Then the Philistines followed hard after Saul and his sons. And the Philistines killed Jonathan, Abinadab, and Malchishua, Saul's _____." **1 SAMUEL 31:2**
- 8 ACROSS "The battle became fierce against Saul. The archers hit him and he was severely wounded by the _____." **1 SAMUEL 31:3**
- 7 DOWN "Then Saul said to his armorbearer, 'Draw your _____, and thrust me through with it, lest these uncircumcised men come and thrust me through and abuse me.'" **1 SAMUEL 31:4**
- 5 DOWN "But his armorbearer would not, for he was greatly _____." **1 SAMUEL 31:4**
- 6 ACROSS "And when the men of Israel who were on the other side of the valley, and those who were on the other side of the Jordan, saw that the men of Israel had fled and that Saul and his sons were dead, they forsook the cities and fled; and the _____ came and dwelt in them." **1 SAMUEL 31:7**
- 2 DOWN "When the inhabitants of Jabesh Gilead heard what the Philistines had done to Saul, all the _____ men arose and traveled all night." **1 SAMUEL 31:11**
- 3 DOWN They "took the body of Saul and the bodies of his sons from the wall of _____." **1 SAMUEL 31:12**
- 10 ACROSS "Then they took their bones and buried them under the tamarisk tree at Jabesh, and _____ seven days." **1 SAMUEL 31:13**

Bible Story 83

**DAVID IS MADE
KING OF ISRAEL**

2 SAMUEL 5:1-4

83. DAVID IS MADE KING OF ISRAEL

(2 SAMUEL 5:1-4)



"Now therefore, thus shall you say to My servant David,
'Thus says the LORD of hosts: I took you from the sheepfold, from
following the sheep, to be ruler over My people, over Israel.' "

2 SAMUEL 7:8

83. DAVID IS MADE KING OF ISRAEL

(2 SAMUEL 5:1-4)

MEMORY VERSE:

"Now therefore, thus shall you say to My servant David, 'Thus says the LORD of hosts: "I took you from the sheepfold, from following the sheep, to be ruler over My people, over Israel." 2 SAMUEL 7:8

TRUE OR FALSE:

1. Then only the tribe of Judah came to David at Hebron and spoke, saying, "Indeed we are your bone and your flesh." **2 SAMUEL 5:1**
TRUE OR FALSE

CIRCLE THE CORRECT WORD:

2. "Also, in time past, when (**SAMUEL, SAUL**) was king over us, you were the one who led Israel out and brought them in." **2 SAMUEL 5:2**
3. "And the LORD said to you, 'You shall shepherd My people Israel, and be (**FLOATING, RULER**) over Israel.'" **2 SAMUEL 5:2**

TRUE OR FALSE:

4. "So all the elders of Israel came to the king at Hebron, and King David made a covenant with them at Hebron before the LORD." **2 SAMUEL 5:3**
TRUE OR FALSE
5. "And they anointed David king over Israel." **2 SAMUEL 5:3**
TRUE OR FALSE

FILL IN THE BLANKS:

6. "David was _____ years old when he began to reign, and he reigned _____ years." **2 SAMUEL 5:4**

83. DAVID IS MADE KING OF ISRAEL

(2 SAMUEL 5:1-4)

A D I V A D I Q F S P Z U R U
M Q W Z Q J O R V T P G N I K
X Z X C J T T I X L R W M M O
T L O R D E A L H V E I I G M
Y U D R E H P E H S J A B R L
L A P C B J N S S O E B R E L
R N E Q B Z R T V J H L M S S
E M S I R Z P F M R G M F G I
I M E L A S U R E J E N G N M
G G G W B K I L A J U O Y G S
N F D Z K R U A Z E W R P Z Z
I H E K E R Q Y S A D B Y J F
C O V E N A N T H W W E N O B
O A P N F T D Y M L Y H B P P
V H A D U J J O X Z P W D N G

BONE
COVENANT
DAVID
FLESH
HEBRON

ISRAEL
JERUSALEM
JUDAH
KING
LORD

REIGN
RULER
SHEPHERD
TRIBES

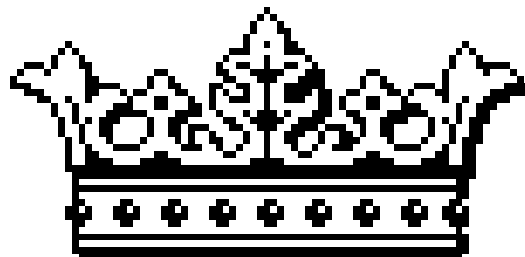

83. DAVID IS MADE KING OF ISRAEL

(2 SAMUEL 5:1-5)

MEMORY VERSE:

"Now therefore, thus shall you say to My servant David, 'Thus says the LORD of hosts: "I took you from the sheepfold, from following the sheep, to be ruler over My people, over Israel." 2 SAMUEL 7:8

TRUE OR FALSE:

1. Then only the tribe of Judah came to David at Hebron and spoke, saying, "Indeed we are your bone and your flesh." **2 SAMUEL 5:1**

TRUE OR FALSE

FILL IN THE BLANKS:

2. "Also, in time past, when _____ was king over us, you were the one who led Israel out and brought them in." **2 SAMUEL 5:2**
3. "And the LORD said to you, 'You shall shepherd My people Israel, and be _____ over Israel.'" **2 SAMUEL 5:2**

TRUE OR FALSE:

4. "So all the elders of Israel came to the king at Hebron, and King David made a covenant with them at Hebron before the LORD." **2 SAMUEL 5:3**

TRUE OR FALSE

5. "And they anointed David king over Israel." **2 SAMUEL 5:3**

TRUE OR FALSE

FILL IN THE BLANKS:

6. "David was _____ years old when he began to reign, and he reigned _____ years." **2 SAMUEL 5:4**
7. "In _____ he reigned over Judah seven years and six months, and in _____ he reigned thirty-three years over all Israel and Judah." **2 SAMUEL 5:5**

83. DAVID IS MADE KING OF ISRAEL

(2 SAMUEL 5:1-4)

N K X H C M O D Q I M C A F L T O F T L P R F R M
G K O T T D N D U Y J H K B A W L O P J A D V M L
K O S Y C W H Q L B K R U E O B O E L T U N F N C
B J L O J T I C F E G S H E P H E R D W V J H B S
Y Q H A W Q H L Q B A E N H A H U P J K A U N I G
K S K A Y M E I T P H R U T P J I N G I E R E F E
P P W V D S U U R P G M S L A Q I K N O R B E H Y
U M V C H U A J H T D Q D I D K B J B M E Y E W U
Y B J A J I J K T Y Y N L U Y P R F J L I E M L W
F B X L T T F S T F V Y U W S G W Y H T S E J J I
K O W O K I N G R O D Y E Q M K G T T N G J Q B A
T H E Z N A F M R J B I F A U G T W J A J A V B C
G S L M A L D J W W G M V N R E K U Y N P V E K L
E S R F S B R T P S C A L A L S N G R E Z K V J P
Y R V U L Z O J N S Z S Y I D P O O D V F U V K A
G V D M L Z L A E I H V H S S S W L B O B O L U I
M N D Q P E T A K R K Y V V E O I H D C B Z A M E
Q G Z S U N R U B A U K O U J T S Y C N M L I N Y
H D Z Q T K Q E C G K S I U M W E V G G M A L Y A
V P O V N O H N D W R W A A G I B S S C Z M R R Q
V K W P D B A Q W A E L R L O H I U Q V P Z U T A
G S H B R H U W K F N W F D E J R G U U I B U T O
S P Q Q A F U N I N N W Y D V M T H M B Z T C C Y
N P I J Z V T A E T V Z B W S D U U J N F P Q M E
B R L I E I T Y P O C O D T P U M Q Q H Z Z N P A

BONE
COVENANT
DAVID
FLESH

HEBRON
ISRAEL
JERUSALEM
JUDAH

KING
LORD
REIGN
RULER

SHEPHERD
THIRTY YEARS OLD
TRIBES

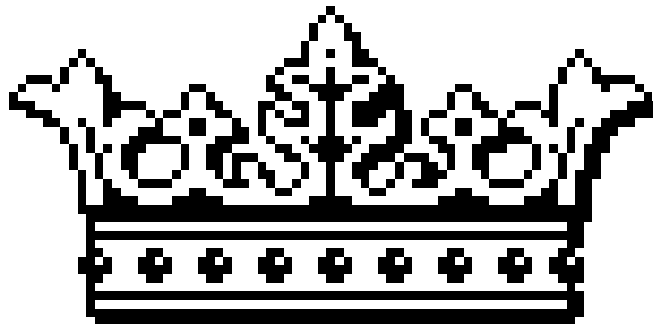

83. DAVID IS MADE KING OF ISRAEL

(2 SAMUEL 5:1-4)

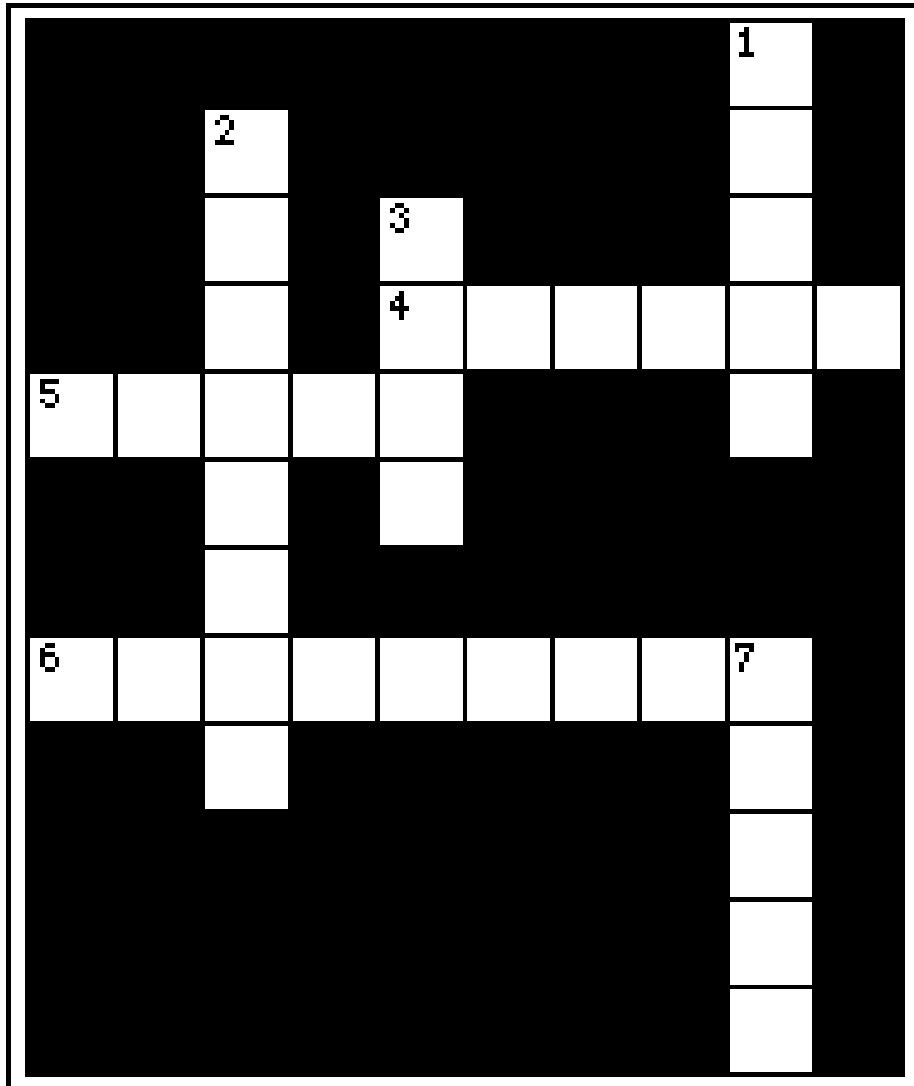

- 6 ACROSS "Now therefore, thus shall you say to My servant David, 'Thus says the LORD of hosts: "I took you from the _____ from following the sheep, to be ruler over My people, over Israel." **2 SAMUEL 7:8**
- 7 DOWN "Then all the tribes of Israel came to _____ at Hebron and spoke, saying, 'Indeed we are your bone and your flesh.'" **2 SAMUEL 5:1**
- 4 ACROSS "Also, in time past, when Saul was king over us, you were the one who led _____ out and brought them in." **2 SAMUEL 5:2**
- 1 DOWN "And the LORD said to you, 'You shall shepherd My people Israel, and be _____ over Israel.'" **2 SAMUEL 5:2**
- 3 DOWN "So all the elders of Israel came to the _____ at Hebron, and King David made a covenant with them at Hebron before the LORD." **2 SAMUEL 5:3**
- 2 DOWN "And they _____ David king over Israel." **2 SAMUEL 5:3**
- 5 ACROSS "David was thirty years old when he began to _____, and he reigned forty years." **2 SAMUEL 5:4**

Bible Story 84

**THE ARK
IS BROUGHT
TO JERUSALEM**

2 SAMUEL 6:1-19

84. THE ARK IS BROUGHT TO JERUSALEM

(2 SAMUEL 6:1-19)

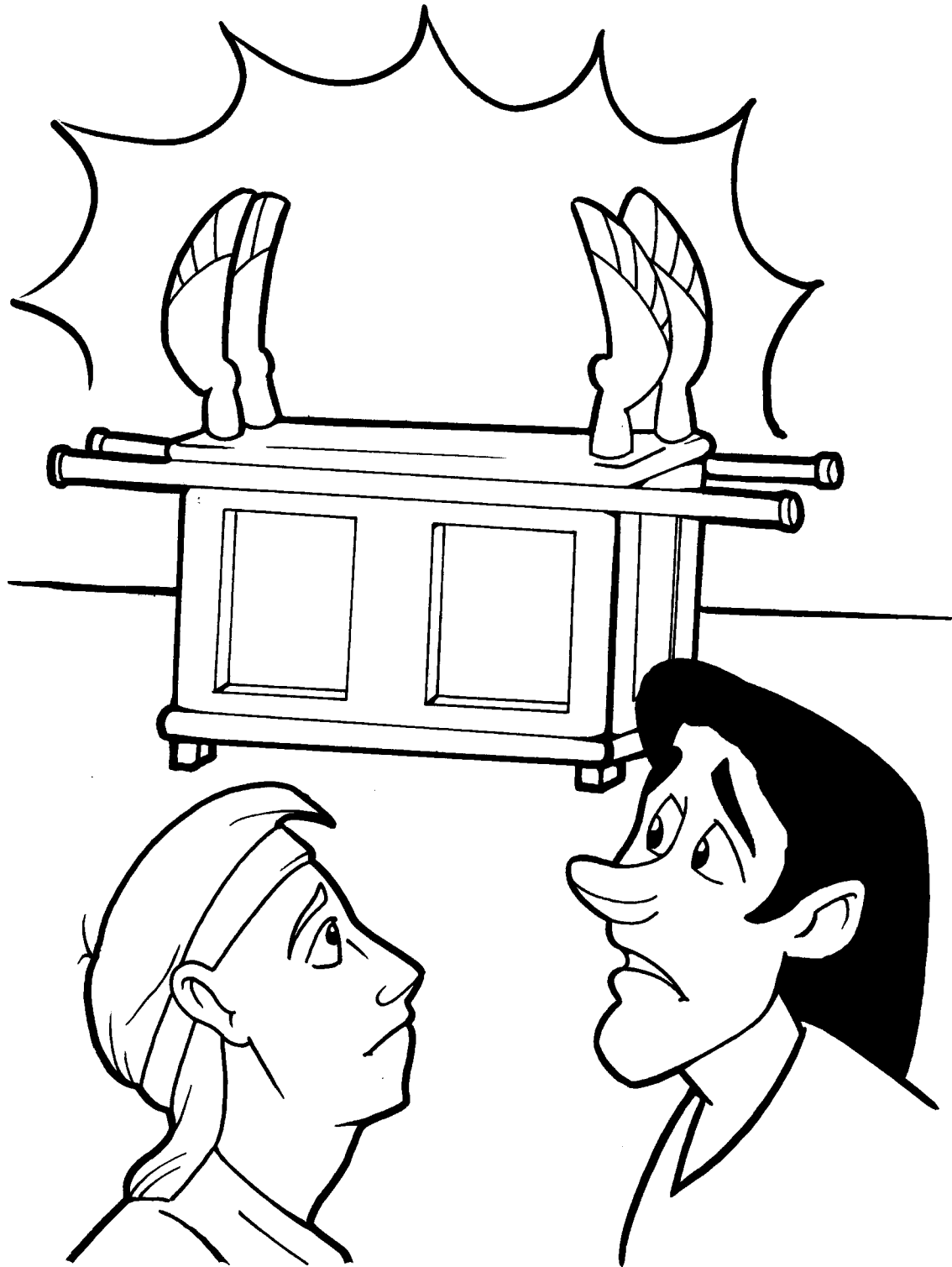

"And the anger of the LORD was kindled against Uzzah; and God smote him there for *his* error; and there he died by the ark of God."

2 SAMUEL 6:7

84. THE ARK IS BROUGHT TO JERUSALEM

(2 SAMUEL 6:1-19)

MEMORY VERSE:

"And David arose and went with all the people who were with him from Baale Judah to bring up from there the ark of God, whose name is called by the Name, the LORD of Hosts, who dwells between the cherubim." 2 SAMUEL 6:2

FILL IN THE BLANK:

1. "David gathered all the choice men of Israel, thirty _____." 2 SAMUEL 6:1

TRUE OR FALSE:

2. "So they set the ark of God on a new cart, and brought it out of the house of Abinadab." 2 SAMUEL 6:3

TRUE OR FALSE

3. The anger of the Lord was aroused against Ohuzro, and God struck him there for his error; and he died there by the ark of God. 2 SAMUEL 6:7

TRUE OR FALSE

4. "The ark of the Lord remained in the house of Obed-Edom three months." 2 SAMUEL 6:11

TRUE OR FALSE

5. "And so it was, when those bearing the ark of the Lord had gone six paces, that he sacrificed oxen and fatted sheep." 2 SAMUEL 6:13

TRUE OR FALSE

CIRCLE THE CORRECT WORDS:

6. "So David and all the house of Israel brought up the ark of the Lord with (SHOUTING, WHISPERS) and with the sound of the trumpet." 2 SAMUEL 6:15

7. "So they brought the ark of the LORD, and set it in its place in the (MIDST, CORNER) of the tabernacle that David had erected for it. Then David offered (NO, BURNT)offerings and (WAR, PEACE) offerings before the LORD." 2 SAMUEL 6:17

UNDERLINE THE CORRECT ANSWER:

8. "He distributed among all the people, among the whole multitude of Israel, both the women and the men, to everyone..." 2 SAMUEL 6:19
- a loaf of bread
 - a piece of meat
 - a cake of raisins
 - all of the above

"So all the people departed, everyone to his house." 2 SAMUEL 6:19

84. THE ARK IS BROUGHT TO JERUSALEM

(2 SAMUEL 6:1-19)

T U C O A J P F Q U L T Q I A
 A M M N O T J S O H W C L J C
 B D G I J P H W E P J S K N I
 E E L T F L Q U W C A R T E S
 R L D E C I F I R C A S D M U
 N D B E A J O D E E U C D E M
 A E P J H C U Z Z A H H O C V
 C C A K A V A D I V A D K I D
 L N C K H T W S B V O U Q O Q
 E A W P Z B A D A N I B A H E
 B D S G N I R E F F O E K C N
 U S J Z Y W V J K A E C L S R
 O B E D E D O M B L E S S E D
 W V M Y N H M H S R P N W U Y
 C R K Y D O G F O K R A K E Y

ABINADAB
 ANGER
 TABERNACLE
 UZZAH

CHOICE MEN
 DANCED
 ARK OF GOD
 CART

MUSIC
 OBED-EDOM
 DAVID

SACRIFICED
 BLESSED
 OFFERINGS

FOLLOW THE PATH OF THE ARK FROM OBED-EDOM TO THE CITY OF DAVID
 AND WRITE DOWN THE LETTERS YOU COME TO ON THE LINES BELOW

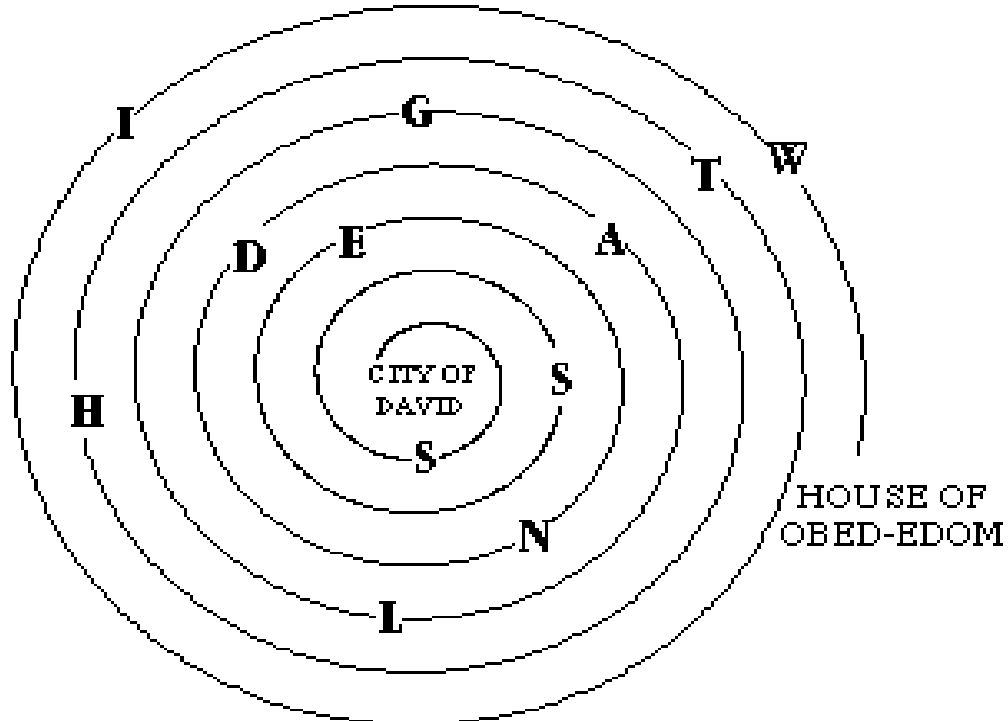

"-----"

84. THE ARK IS BROUGHT TO JERUSALEM

(2 SAMUEL 6:1-19)

MEMORY VERSE:

"And David arose and went with all the people who were with him from Baale Judah to bring up from there the ark of God, whose name is called by the Name, the LORD of Hosts, who dwells between the cherubim." 2 SAMUEL 6:2

FILL IN THE BLANKS:

1. "David gathered all the choice men of Israel, _____."
2 SAMUEL 6:1
2. "So they set the ark of God on a new _____, and brought it out of the house of Abinadab." **2 SAMUEL 6:3**

TRUE OR FALSE:

3. The anger of the Lord was aroused against Ohuzro, and God struck him there for his error; and he died there by the ark of God. **2 SAMUEL 6:7**
TRUE OR FALSE
4. "The ark of the Lord remained in the house of Obed-Edom three months." **2 SAMUEL 6:11**
TRUE OR FALSE

FILL IN THE BLANKS:

5. "And so it was, when those bearing the ark of the Lord had gone six paces, that he sacrificed _____ and fatted _____." **2 SAMUEL 6:13**
6. "So David and all the house of Israel brought up the ark of the Lord with _____ and with the sound of the _____." **2 SAMUEL 6:15**

CIRCLE THE CORRECT WORDS:

7. "So they brought the ark of the LORD, and set it in its place in the (**MIDST**, **CORNER**) of the tabernacle that David had erected for it. Then David offered (**NO**, **BURNT**)offerings and (**WAR**, **PEACE**) offerings before the LORD." **2 SAMUEL 6:17**

UNDERLINE THE CORRECT ANSWER:

8. "He distributed among all the people, among the whole multitude of Israel, both the women and the men, to everyone..." **2 SAMUEL 6:19**
 - a. a loaf of bread
 - b. a piece of meat
 - c. a cake of raisins
 - d. all of the above

"So all the people departed, everyone to his house." 2 SAMUEL 6:19

84. THE ARK IS BROUGHT TO JERUSALEM

(2 SAMUEL 6:1-19)

P B D Q D G Z M D B W G S G H R C E K V V J W T U
 U H Q X W W H A L E T O O T X D V I X F L B I K M
 T M C N K A K S U H L V T K V C U S U H A B A N E
 N V U A I L K V O T A O F F E R I N G S I K C B S
 D I S Y E F O B F L O S W W S G B G Y N L J L Y Z
 R O J S P U E R L U A A N G E R N G N I T U O H S
 A N K Q E D R Y D M E L A S U R E J E E R P P Z P
 Z H S U E N E K Y O P P I I U S H J E E U U A A J
 E I M D I T D W H W F T H U L Q T P J M U M I X H
 M U O Q Y O N A X Q A H J M H U A Z A D C N E U D
 D M J T B A C L L N D W O F U M B F V E Q Y Y E C
 W A T H B T R W O G Y B D S Q J E B K C N R A D U
 Q F A T P M R K I I S H U O T Q R N M I R T Q K U
 X F C T P J V U O S M J O E T S N K O F N T A D S
 I T A H Y K C C M F B Y L P P L A M Z I H C O E Y
 T Q U R O G C W I P G K O K L J C Z X R A M Y C J
 A H E R F I H Z R T E O U J B T L X A C Z P E N G
 C A R T O H C O F V Y T D L J D E I M A Z M A A A
 L A C W J G R E Y U L O E F B W A Z Z S U L E D K
 B U I P W D E A M U S S F Y J K X V B J K C Q G R
 Z U S N S V M K R E S P I D H M A F I Q B S U C B
 Z T N K S B Q U D E N G I T A L U Z T D I G T M N
 N T M B I G N N D A E K B W T V V N P V F E V N Y
 K A B I N A D A B D J G R U J U I D Z E W Y S Q N
 O D N C A C Y U F D M P W G Y G A D F V L U E R M

- | | | | |
|---------------|---------------|---------------|------------|
| ABINADAB | CHOICE MEN | JERUSALEM | SACRIFICED |
| ANGER | CITY OF DAVID | LORD OF HOSTS | SHOUTING |
| ARK OF GOD | DANCED | MUSIC | TABERNACLE |
| BLESSED | DAVID | OBED-EDOM | TRUMPET |
| CART GLADNESS | OFFERINGS | UZZAH | |

FOLLOW THE PATH OF THE ARK FROM OBED-EDOM TO THE CITY OF DAVID
 AND WRITE DOWN THE LETTERS YOU COME TO ON THE LINES BELOW

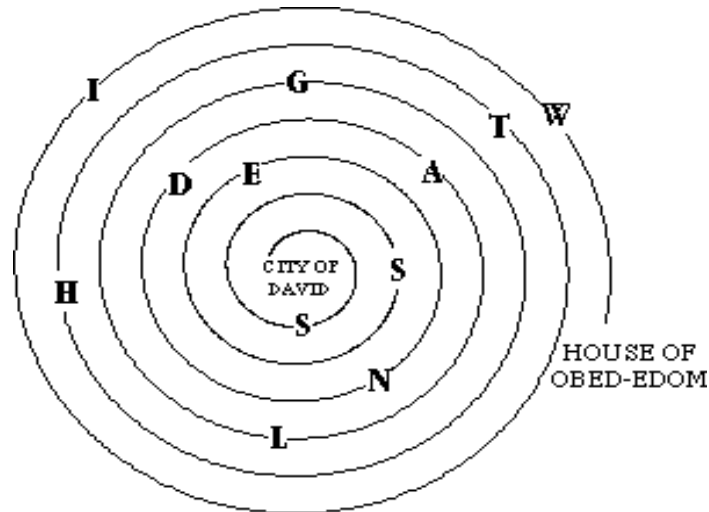

"-----"

84. THE ARK IS BROUGHT TO JERUSALEM

(2 SAMUEL 6:1-19)

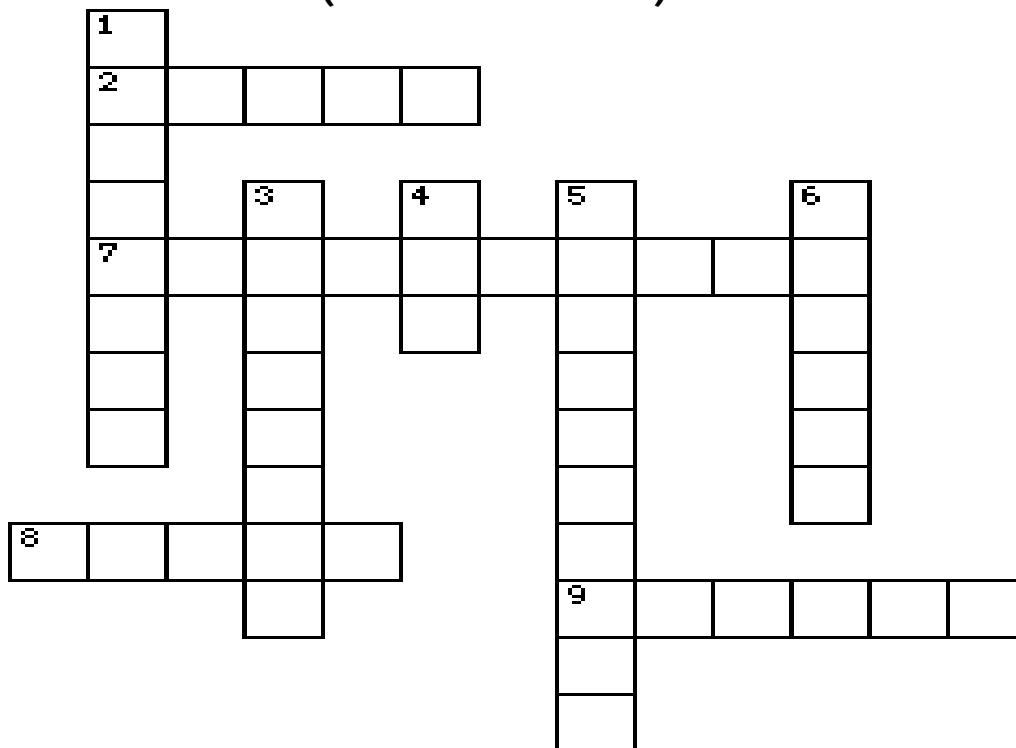

- 4 DOWN "And David arose and went with all the people who were with him from Baale Judah to bring up from there the _____ of God, whose name is called by the Name, the LORD of Hosts, who dwells between the cherubim." **2 SAMUEL 6:2**
- 9 ACROSS "David gathered all the _____ men of Israel, thirty thousand." **2 SAMUEL 6:1**
- 3 DOWN "So they set the ark of God on a new cart, and brought it out of the house of _____." **2 SAMUEL 6:3**
- 8 ACROSS "The anger of the Lord was aroused against _____, and God struck him there for his error; and he died there by the ark of God." **2 SAMUEL 6:7**
- 2 ACROSS "The ark of the Lord remained in the _____ of Obed-Edom three months." **2 SAMUEL 6:11**
- 5 DOWN "And so it was, when those bearing the ark of the Lord had gone six paces, that he _____ oxen and fatted sheep." **2 SAMUEL 6:13**
- 1 DOWN "So David and all the house of Israel brought up the ark of the Lord with _____ and with the sound of the trumpet." **2 SAMUEL 6:15**
- 7 ACROSS "So they brought the ark of the LORD, and set it in its place in the midst of the _____ that David had erected for it. Then David offered burnt offerings and peace offerings before the LORD." **2 SAMUEL 6:17**
- 6 DOWN "He distributed among all the _____, among the whole multitude of Israel, both the women and the men, to everyone a loaf of bread, a piece of meat, and a cake of raisins." **2 SAMUEL 6:19**

"So all the people departed, everyone to his house." 2 SAMUEL 6:19

Bible Story 85

**GOD'S COVENANT
WITH DAVID**

2 SAMUEL 7:1-17

85. GOD'S COVENANT WITH DAVID (2 SAMUEL 7:1-17)



"Now therefore so shalt thou say unto my servant David, Thus saith the LORD of hosts, I took thee from the sheepcote, from following the sheep, to be ruler over my people, over Israel." **2 SAMUEL 7: 8**

"And thine house and thy kingdom shall be established for ever before thee:
thy throne shall be established for ever." **2 SAMUEL 7: 16**

85. GOD'S COVENANT WITH DAVID

(2 SAMUEL 7:1-17)

MEMORY VERSE:

"And your house and your kingdom shall be established forever before you. Your throne shall be established forever." 2 SAMUEL 7:16

TRUE OR FALSE

1. "Now it came to pass when the king was dwelling in his house, and the LORD had given him rest from all his enemies all around, that the king said to Nathan the prophet, 'See now, I dwell in a house of cedar, but the ark of God dwells inside tent curtains.' "
2 SAMUEL 7:1-2

TRUE OR FALSE

"But it happened that night that the word of the LORD came to Nathan, saying..."
2 SAMUEL 7:4

CIRCLE THE CORRECT WORDS:

2. "Go and tell My servant David, 'Thus says the LORD: "Would you build a (**HOUSE, BARN**) for Me to dwell in? For I have not dwelt in a house since the time that I brought the children of Israel up from Egypt, even to this day, but have moved about in a (**WAGON, TENT**) and in a (**TABERNACLE, CART**). In all the places where I have walked with all the children of Israel, have I ever spoken a word to anyone from the tribes of Israel, whom I commanded to shepherd My people Israel, saying, 'Why have you not built Me a house of cedar?' " "
2 SAMUEL 7:5-7

3. "Now therefore, thus you shall say to My servant David, 'Thus says the LORD of hosts: "I took you from the sheepfold, from following the sheep, to be (**FIGHTING, RULER**) over My people, over Israel.'" **2 SAMUEL 7:8**

TRUE OR FALSE:

4. Also the LORD said, "When your days are fulfilled and you rest with your fathers, I will set up your seed after you, who will come from your body, and I will establish his kingdom. He shall build a house for My name, and I will establish the throne of his kingdom forever." **2 SAMUEL 7:12-13**

TRUE OR FALSE

5. Again He said, "And your house and your kingdom shall be established forever before you. Your throne shall be established forever." **2 SAMUEL 7:16**

TRUE OR FALSE

"According to all these words and according to all this vision, so Nathan spoke to David." 2 SAMUEL 7:17

85. GOD'S COVENANT WITH DAVID (2 SAMUEL 7:1-17)

K S W E I J T V S J J W F G F
 I G Z F O Q F P H E H B I N L
 N D K J T R A S M A G M N S L
 G E K T A R N A H T A N G L M
 D P R E V E R O F E E W Y L S
 O D Q E N S Y V M K P U T E Z
 M O J J R T Y A M W I N P W F
 F G B Z P I N K R A E N Y D P
 H D E H S I L B A T S E G G G
 A Z B Z I D I V A D W E B Z K
 W C E S U O H M S L D N D J H
 L C R K Q L O A V Z W O R P E
 T A B E R N A C L E Y R C N A
 P Q B C D S F Z O P P H G U R
 E I K T D R O L J P Z T R O T

ARK	GOD	KING	REST
DAVID	HEART	LORD	TABERNACLE
DWELLS	HOUSE	NAME	TENT
ESTABLISHED	KINGDOM	NATHAN	THRONE
FOREVER			

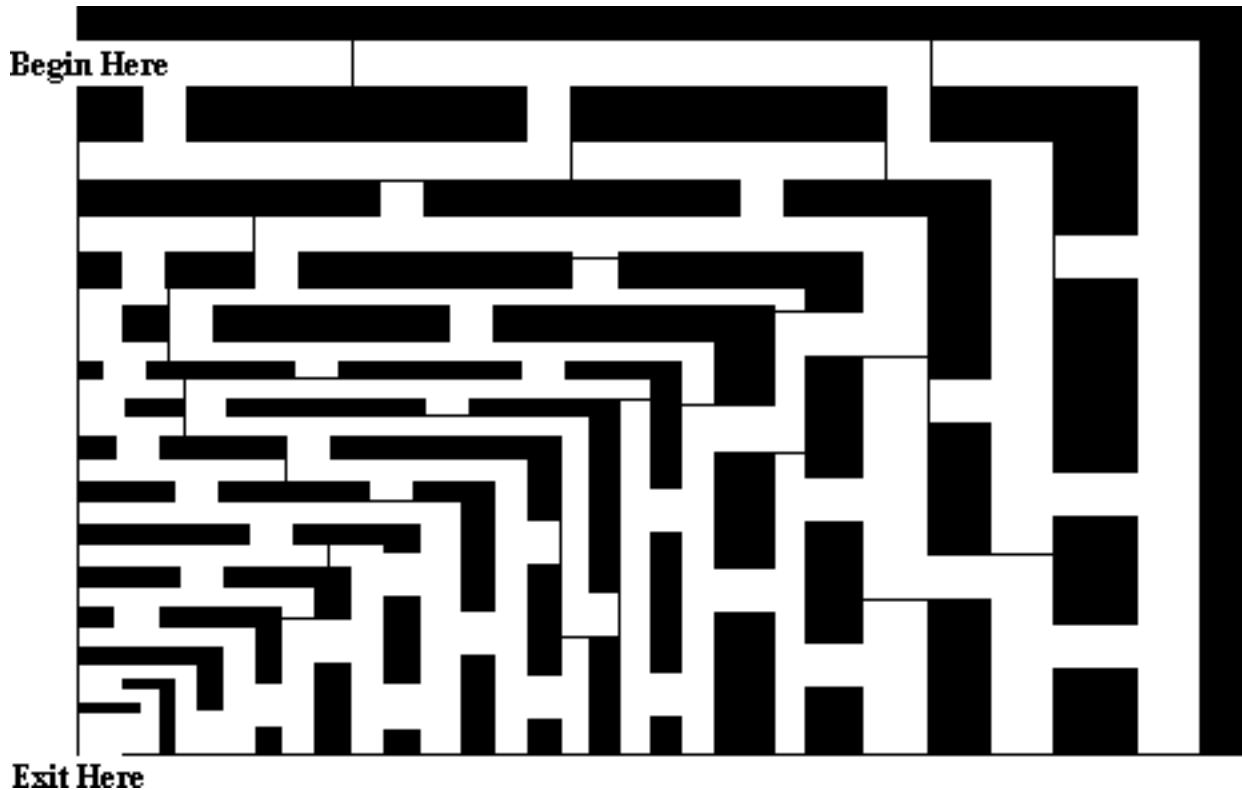

85. GOD'S COVENANT WITH DAVID

(2 SAMUEL 7:1-17)

MEMORY VERSE:

"And your house and your kingdom shall be established forever before you. Your throne shall be established forever." 2 SAMUEL 7:16

TRUE OR FALSE

1. "Now it came to pass when the king was dwelling in his house, and the LORD had given him rest from all his enemies all around, that the king said to Nathan the prophet, 'See now, I dwell in a house of cedar, but the ark of God dwells inside tent curtains.' "
2 SAMUEL 7:1-2

TRUE OR FALSE

"But it happened that night that the word of the LORD came to Nathan, saying,..."
2 SAMUEL 7:4

FILL IN THE BLANKS:

2. "Go and tell My servant David, 'Thus says the LORD: "Would you build a _____ for Me to dwell in? For I have not dwelt in a _____ since the time that I brought the children of Israel up from Egypt, even to this day, but have moved about in a _____ and in a _____. In all the places where I have walked with all the children of Israel, have I ever spoken a word to anyone from the tribes of Israel, whom I commanded to shepherd My people Israel, saying, 'Why have you not built Me a _____ of cedar?' " ' **2 SAMUEL 7:5-7**
3. "Now therefore, thus you shall say to My servant David, 'Thus says the LORD of hosts: "I took you from the sheepfold, from _____ the sheep, to be _____ over My people, over Israel." **2 SAMUEL 7:8**

TRUE OR FALSE:

4. Also the LORD said, "When your days are fulfilled and you rest with your fathers,..."
- a. I will set up your seed after you, who will come from your body (7:12) T or F
 - b. I will establish his kingdom (7:12) T or F
 - c. He shall build a house for his own name (7:13) T or F
 - d. He shall build a house for My name (7:13) T or F
 - e. I will establish the throne of his kingdom forever." (7:13) T or F

FILL IN THE BLANKS:

5. Again He said, "And your house and your kingdom shall be established _____ before you. Your throne shall be established _____." **2 SAMUEL 7:16**

"According to all these words and according to all this vision, so Nathan spoke to David." 2 SAMUEL 7:17

85. GOD'S COVENANT WITH DAVID

(2 SAMUEL 7:1-17)

B O O T T Q U J T P G Q D T A B O I Q T V X N I G
 Y J S Y C X A K T Y D N L L P H U U T W A U E F E
 K Q L O J I F S N F V Y U U A J I M P K E Y E W Y
 P S K G W E F M R A B D W E L L S F L M I E M L U
 U P N A Y T S E R O H M F W D Y I O J L S E J J W
 Y I W V J A S T R J G T A R K K B E M A N J Q B I
 K M V C T T T J A W C A A Q Y P R E E N O R H T A
 F B J A N L Q T W B Z S L N S G W P B U G A V B C
 K B X L A B H A P S L V Y N M R K P J G J V E K L
 T O W O S Z A A N S H I H I U G I J H R P K V J P
 G H E Z T E N T K I E Y S S N P N F T E Z U V K A
 E S L M L Z U U B A K S R H S S G Y J V F O L U I
 Y S V F P N D E C G K K U V E D D T Y E B Z A M E
 G R H M U K R N D W R W O O E D O W R R N R I X Y
 M V D E T O O T W A E L I U H O M G D O K A L Y A
 Q N D Q A B L Q A F N W R U J T G U C F M M R R Q
 H G Z S N R U X K B C W F A M W T G G C Z Z U T A
 V D Z Q D H T N I U E Z Y D P I D H S V N B U T O
 V P O V R F T A E T V R X D O H I P Q U I T C C Y
 G K W P A V T Y P O C O N W V J V V U B Z P Q M E
 S S H B Z I D Q I M C A D A S D A S M N F Z N P A
 N P Q Q E O D U Y J H L F T C N D U J H Z F R M E
 B P I J M N Q Q B K R U B L P L K P Q B R V N L Q
 K R L I D H C T B G E N E A T O E H L A D F B C Z
 K X H C W I U H P H M U H O W L W U J B P H B S T

ARK
 DAVID
 DWELLS
 ESTABLISHED
 FOREVER

GOD
 HEART
 HOUSE
 KINGDOM

KING
 LORD
 NAME
 NATHAN

REST
 TABERNACLE
 TENT
 THRONE

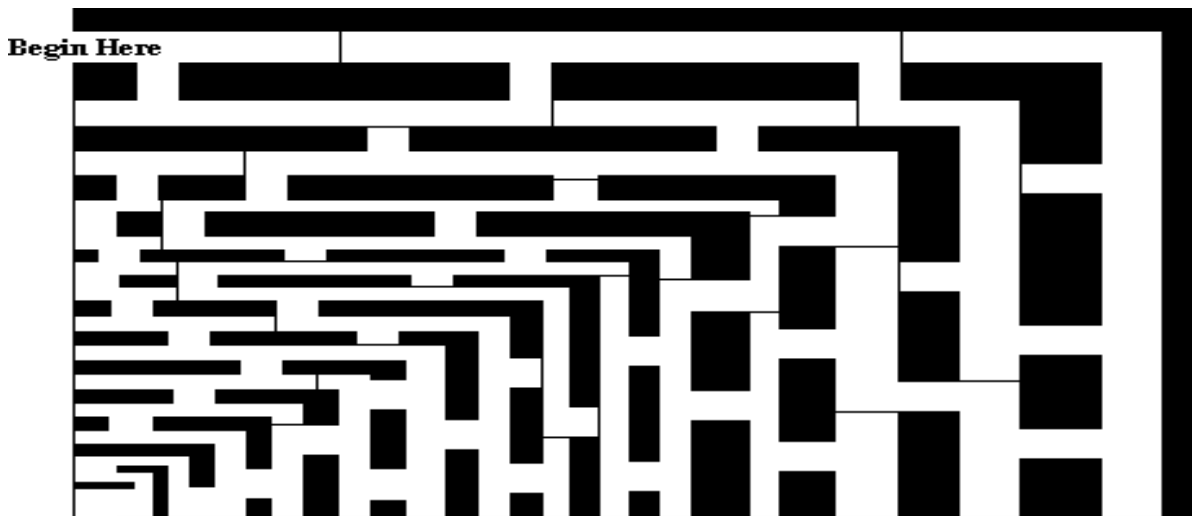

Exit Here

85. GOD'S COVENANT WITH DAVID

(2 SAMUEL 7:1-17)

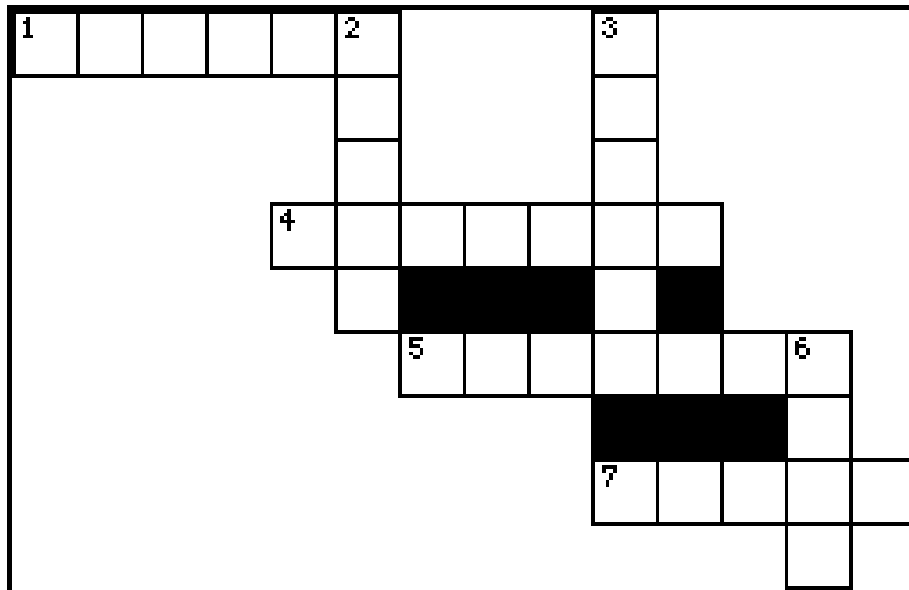

- 5 ACROSS "And your house and your kingdom shall be established forever before you. Your throne shall be established _____." **2 SAMUEL 7:16**
- 6 DOWN "Now it came to pass when the king was dwelling in his house, and the LORD had given him _____ from all his enemies all around, that the king said to Nathan the prophet, 'See now, I dwell in a house of cedar, but the ark of God dwells inside tent curtains.'" **2 SAMUEL 7:1-2**
- 7 ACROSS "Go and tell My servant David, 'Thus says the LORD: "Would you build a _____ for Me to dwell in? For I have not dwelt in a house since the time that I brought the children of Israel up from Egypt, even to this day, but have moved about in a tent and in a tabernacle." ' " **2 SAMUEL 7:5-6**
- 1 ACROSS "In all the places where I have _____ with all the children of Israel, have I ever spoken a word to anyone from the tribes of Israel, whom I commanded to shepherd My people Israel, saying, 'Why have you not built Me a house of cedar?' " **2 SAMUEL 7:7**
- 2 DOWN "Now therefore, thus you shall say to My servant _____, 'Thus says the LORD of hosts: "I took you from the sheepfold, from following the sheep, to be ruler over My people, over Israel." " **2 SAMUEL 7:8**
- 4 ACROSS Also the LORD said, "When your days are fulfilled and you rest with your fathers, I will set up your seed after you, who will come from your body, and I will establish his _____. He shall build a house for My name, and I will establish the throne of his kingdom forever." **2 SAMUEL 7:12-13**
- 3 DOWN Again He said, "And your house and your kingdom shall be established forever before you. Your _____ shall be established forever." **2 SAMUEL 7:16**

"According to all these words and according to all this vision, so Nathan spoke to David." 2 SAMUEL 7:17

Bible Story 86

**DAVID IS KIND TO
MEPHIBOSHETH**

2 SAMUEL 9:1-13

86. DAVID IS KIND TO MEPHIBOSHETH
(2 SAMUEL 9:1-13)



"Then the king called to Ziba, Saul's servant, and said unto him, I have given unto thy master's son all that pertained to Saul and to all his house."

2 SAMUEL 9:9

86. DAVID IS KIND TO MEPHIBOSHETH

(2 SAMUEL 9:1-13)

MEMORY VERSE:

"Let Your tender mercies come to me, that I may live; for Your law is my delight." PSALM 119:77

TRUE OR FALSE:

1. "Now David said, 'Is there still anyone who is left of the house of Saul, that I may show him kindness for Jonathan's sake?' " **2 SAMUEL 9:1**

TRUE OR FALSE

2. "Ziba said to the king, 'There is still a son of Jonathan who is lame in his feet.' " **2 SAMUEL 9:3**

TRUE OR FALSE

CIRCLE THE CORRECT WORDS:

3. "Now when Mephibosheth the son of Jonathan, the son of Saul, had come to David, he fell on his (**KNEES, FACE**) and prostrated himself." **2 SAMUEL 9:6**

4. "And the king called to Ziba, Saul's servant, and said to him, 'I have given to your master's son (**NOTHING, ALL**) that belonged to Saul and to all his house.' " **2 SAMUEL 9:9**

5. "You therefore, and your sons and your servants, shall (**WORK, LEAVE**) the land for him, and you shall bring in the harvest, that your master's son may have food to eat. But Mephibosheth your master's son shall eat bread at my (**JAIL, TABLE**) always." **2 SAMUEL 9:10**

6. "Then Ziba said to the king, 'According to all that my lord the king has commanded to his servant, so (**WILL, WILL NOT**) your servant do.' " **2 SAMUEL 9:11**

TRUE OR FALSE:

7. " 'As for Mephibosheth,' said the king, 'he shall eat at my table like one of the king's sons.' " **2 SAMUEL 9:11**

TRUE OR FALSE

FILL IN THE BLANKS:

8. "Mephibosheth had a young son whose name was _____. And all who dwelt in the house of Ziba were servants of Mephibosheth." **2 SAMUEL 9:12**

9. "So Mephibosheth dwelt in Jerusalem, for he ate continually at the king's And he was _____ in both his feet." **2 SAMUEL 9:13**

86. DAVID IS KIND TO MEPHIBOSHETH

(2 SAMUEL 9:1-13)

J K A L W A Y S H N V A L U X
 I P J K K G J O N A T H A N H
 M N E L J D A V I D T A U B I
 E T O I B B I M V E R F W J I
 L T M S R K E D H A S F R S W
 A A I N B Y S S A S O T E E F
 S B C G R N O Z E T Z V G D H
 U L H C W B I N K S U I M N S
 R E A K I V D R I E Q G B Q E
 E E W H Q N X B T V C E Q A I
 J N P D I H T J B R T S K T K
 O E P K D E E I R A R A Q B B
 M V K Q L B U M A H D U U E H
 T Q G T H J C E A S Z L Z W A
 G S D V T H E L Y L O N F M G

ALWAYS
 DAVID
 FEET
 HARVEST

JERUSALEM
 JONATHAN
 KINDNESS
 LAME

MEPHIBOSHETH
 MICHA
 SAUL

SON
 TABLE
 ZIBA

WRITE DOWN THE LETTERS ON THE LINES BELOW TO FIND THE WORDS OF KING DAVID

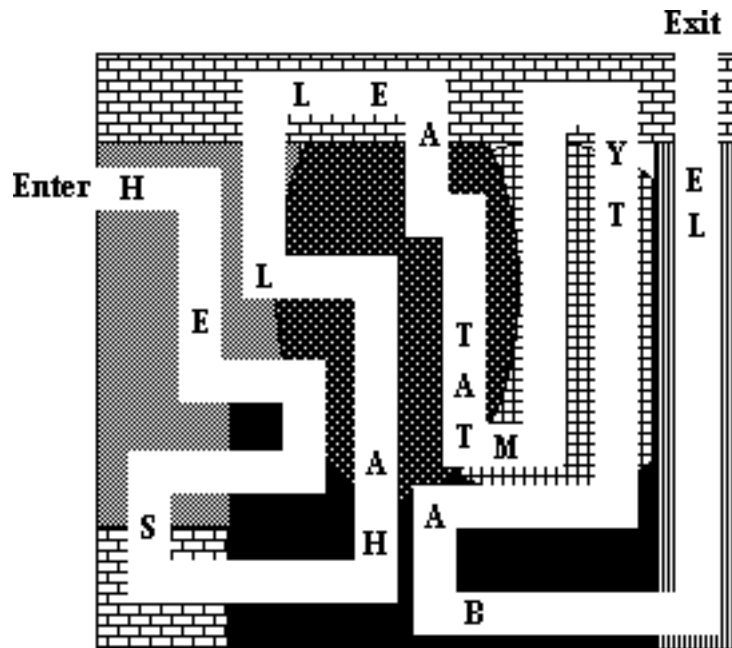

86. DAVID IS KIND TO MEPHIBOSHETH

(2 SAMUEL 9:1-13)

MEMORY VERSE:

"Let Your tender mercies come to me, that I may live; for Your law is my delight."
PSALM 119:77

TRUE OR FALSE:

1. "Now David said, 'Is there still anyone who is left of the house of Saul, that I may show him kindness for Jonathan's sake?' " **2 SAMUEL 9:1**
TRUE OR FALSE

2. "Ziba said to the king, 'There is still a son of Jonathan who is lame in his feet.' "
2 SAMUEL 9:3
TRUE OR FALSE

UNDERLINE THE CORRECT ANSWER:

3. "Now when Mephibosheth the son of Jonathan, the son of Saul, had come to David,..."
2 SAMUEL 9:6
a. he fell on his knees and prostrated himself
b. he fell on his face and prostrated himself
c. he did nothing

4. "And the king called to Ziba, Saul's servant, and said to him, 'I have given to your master's son...' " **2 SAMUEL 9:9**
a. nothing that belonged to Saul and to all his house
b. all that belonged to Saul and to all his house
c. neither of these answers are correct

FILL IN THE BLANKS:

5. "You therefore, and your sons and your servants, shall _____ the land for him, and you shall bring in the harvest, that your master's son may have food to eat. But Mephibosheth your master's son shall eat bread at my table _____." **2 SAMUEL 9:10**

6. "Then Ziba said to the king, 'According to _____ that my lord the king has commanded to his servant, so will your servant do.' "
2 SAMUEL 9:11

7. " 'As for Mephibosheth,' said the king, 'he shall eat at my table like one of the _____.' " **2 SAMUEL 9:11**

8. "Mephibosheth had a young son whose name was _____. And all who dwelt in the house of Ziba were servants of Mephibosheth." **2 SAMUEL 9:12**

9. "So Mephibosheth dwelt in Jerusalem, for he ate continually at the king's _____. And he was _____ in both his feet." **2 SAMUEL 9:13**

86. DAVID IS KIND TO MEPHIBOSHETH (2 SAMUEL 9:1-13)

U C N D E B L P S F I O Z P R J H B C S E V P D U
 I U W J O Z L E T G J L J W N C B Q K H M D A V I D
 W G T Q O F L Y D T S J B U M A O S L E J Q M T A
 V D I I C H B L E E T E M O L T L U E A O D C T V
 B T W K B N A I P J F A W F B A S W C V U V C B R
 M A P T K G T O Z Z A W U L X H A E A L A M E G O
 C S P D B X N V C Z Y L F L A A W H V Y G S V E U
 B S O N A H T A N O J Z I M C H V P N R S M Z I V
 H T W N Y G V Q C K Y B T S W Z M E Q D A C B R Z
 P O Q Y N R Q Z Q C O P G Z J Y F V L Q Q F H F N A
 D T T H M Q T U I T F J Y F U N A B I Z R Z K P U
 E W A U H I A A W I V H M P W J S A K E D L S P E
 B F U Q L P Q N Z O N G E P E O T W R D N B U M U F
 C A U S D H F M K T S E Y G P P U L D R K K T O Z P
 P M M E L A S U R E J U B K I H D W O Y K M A V T
 O F H S R Z H G P A V W D B T L I J K Y A O T F O
 G H E I E I P F F N M D R U E J S B Q D T E M R N
 U K R L U V J E Q R A W C N J C J U O J W M Z K I
 P N J S W V E H J P Z Y G C R V H O K S L P J K J
 M C S J J T T A B I S P R U P L U A S I H N S Y J
 K I N D N E S S B Q H M G M P T Q E L P A E M R Y
 N U T F N B B W R D M I N D Z W O P W T P O T G T
 R Q A F S Q I X B J M C G L Y H E T K V P B X H H
 N D Z O Z Y A P K Q S H Z S Y P W C I R A U P I G
 D C S P K E M E E R V A J V O J E S J F N L C B F

ALWAYS
 DAVID
 FEET
 HARVEST

JERUSALEM
 JONATHAN
 KINDNESS
 LAME

MEPHIBOSHETH
 MICHA
 SAUL

SON
 TABLE
 ZIBA

WRITE DOWN THE LETTERS ON THE LINES BELOW TO FIND THE WORDS OF KING DAVID

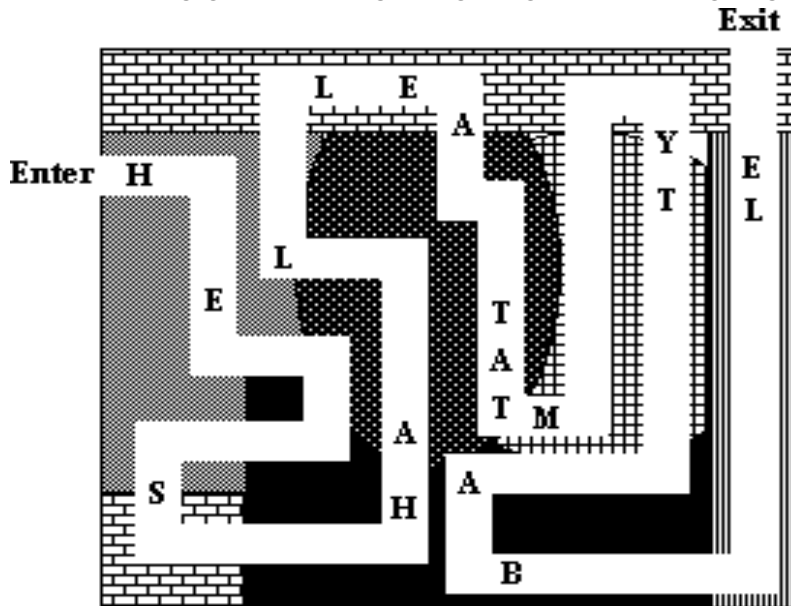

.....

86. DAVID IS KIND TO MEPHIBOSHETH (2 SAMUEL 9:1-13)

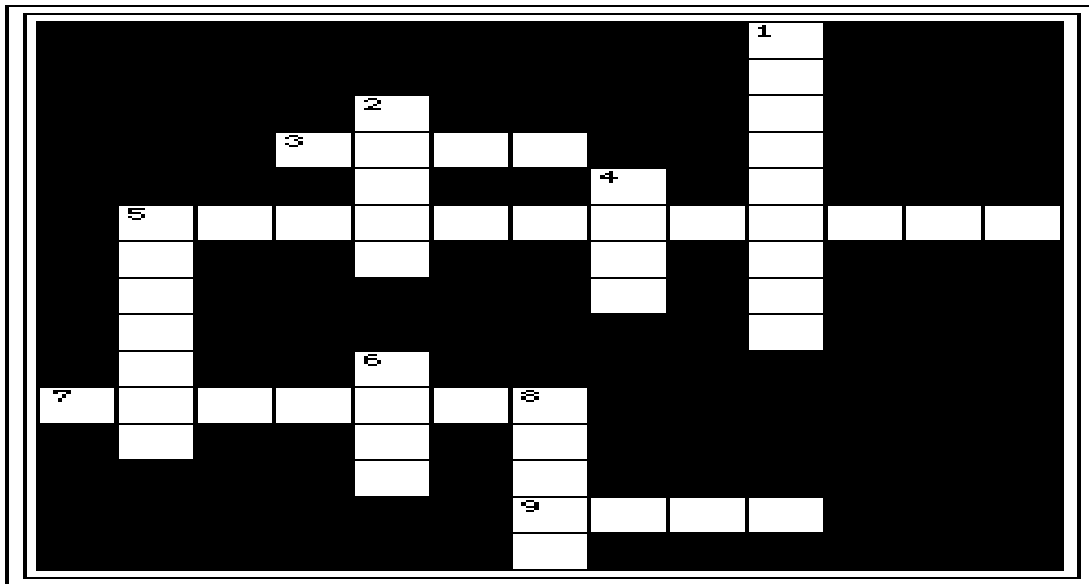

- 5 DOWN "Let Your tender _____ come to me, that I may live; for Your law is my delight." **PSALM 119:77**
- 1 DOWN "Now David said, 'Is there still anyone who is left of the house of Saul, that I may show him kindness for _____ sake?' " **2 SAMUEL 9:1**
- 3 ACROSS "_____ said to the king, 'There is still a son of Jonathan who is lame in his feet.'" **2 SAMUEL 9:3**
- 5 ACROSS "Now when _____ the son of Jonathan, the son of Saul, had come to David, he fell on his face and prostrated himself." **2 SAMUEL 9:6**
- 6 DOWN "And the king called to Ziba, Saul's servant, and said to him, 'I have given to your master's son all that belonged to _____ and to all his house.'" **2 SAMUEL 9:9**
- 8 DOWN "You therefore, and your sons and your servants, shall work the land for him, and you shall bring in the harvest, that your master's son may have food to eat. But Mephibosheth your master's son shall eat bread at my _____ always." **2 SAMUEL 9:10**
- 7 ACROSS "Then Ziba said to the king, 'According to all that my lord the king has commanded to his _____, so will your servant do.'" **2 SAMUEL 9:11**
- 4 DOWN " 'As for Mephibosheth,' said the king, 'he shall eat at my table like one of the king's _____.'" **2 SAMUEL 9:11**
- 2 DOWN "Mephibosheth had a young son whose name was _____. And all who dwelt in the house of Ziba were servants of Mephibosheth." **2 SAMUEL 9:12**
- 9 ACROSS "So Mephibosheth dwelt in Jerusalem, for he ate continually at the king's table. And he was _____ in both his feet." **2 SAMUEL 9:13**

Bible Story 87

**DAVID'S CENSUS,
JUDGMENT AND
PURCHASE OF THE
THRESHING FLOOR**

2 SAMUEL 24:1-25

87. DAVID'S CENSUS, JUDGMENT AND PURCHASE OF THE THRESHING FLOOR
(2 SAMUEL 24: 1-25)



"And David spake unto the LORD when he saw the angel that smote the people, and said, Lo, I have sinned, and I have done wickedly: but these sheep, what have they done? let thine hand, I pray thee, be against me, and against my father's house."

2 SAMUEL 24 : 17

87. DAVID'S CENSUS, JUDGMENT AND PURCHASE OF THE THRESHING FLOOR (2 SAMUEL 24: 1-25)

MEMORY VERSE:

"Please let us fall into the hand of the LORD, for His mercies are great; but do not let me fall into the hand of man." 2 SAMUEL 24:14

TRUE OR FALSE:

1. "Again the anger of the LORD was aroused against Israel, and He moved David against them to say, 'Go, number Israel and Judah.' " **2 SAMUEL 24:1**
TRUE OR FALSE

CIRCLE THE CORRECT WORDS:

2. "And (**SAMUEL, JOAB**) said to the king, 'Now may the LORD your God add to the people a hundredfold more than there are, and may the (**EYES, EARS**) of my lord the king see it. But (**WHY, WHY NOT**) does my lord the king desire this thing?' " **2 SAMUEL 24:3**

TRUE OR FALSE:

3. So Joab and the captains of the army did not go out from the presence of the king to count the people of Israel. **2 SAMUEL 24:4**
TRUE OR FALSE

FILL IN THE BLANKS:

4. "Then Joab gave the sum of the number of the people to the king. And there were in _____ eight hundred thousand valiant men who drew the sword, and the men of _____ were five hundred thousand men." **2 SAMUEL 24:9**

UNDERLINE ALL THE CORRECT ANSWERS:

5. "And David's heart condemned him after he had numbered the people. So David said to the LORD,..." **2 SAMUEL 24:10**
 - a. "I have sinned greatly in what I have done"
 - b. "I pray, O LORD, take away the iniquity of Your servant"
 - c. "I have done very wisely"

"Go and tell David, Thus says the LORD: "I offer you three things; choose one of them for yourself, that I may do it to you." ' " 2 SAMUEL 24:12

TRUE OR FALSE:

6. "David said to Gad, 'I am in great distress. Please let us fall into the hand of the LORD, for His mercies are great; but do not let me fall into the hand of man.'" **2 SAMUEL 24:14**
TRUE OR FALSE

CIRCLE THE CORRECT WORDS:

7. "So the LORD sent a (**FLOOD, PLAGUE**) upon Israel from the morning till the appointed time." **2 SAMUEL 24:15**
8. "And Gad came that day to David and said to him, 'Go up, erect an altar to the LORD on the threshing (**ROOF, FLOOR**) of Araunah the Jebusite.' " **2 SAMUEL 24:18**

87. DAVID'S CENSUS, JUDGMENT AND PURCHASE OF THE THRESHING FLOOR

(2 SAMUEL 24:1-25)

M D D K A A U N C O M G F R E
 E J U R N S T O V A N E R A H
 R I G G O M M B Z T P I K T A
 C P E A L L S L E K E H S L D
 I R D E N M E D N O C B K A U
 E T F T V C T N K P A K Y M J
 S V K W Q N O L F O L X R O F
 D R D L U Z E P J M C A G U P
 Q D R O L E H T F O L E G N A
 E F C A D R E B M U N P I U T
 N E L E A R S I K Z D P K V E
 R D A V I D M M S J T U U Z O
 T H R E S H I N G F L O O R N
 Y J B P V L L C M S M Z A A I
 Y O K P D E N N I S B V V U J

ALTAR
 ANGER
 ANGEL OF THE LORD
 CONDEMNED

COUNT
 DAVID
 ISRAEL
 JOAB

JUDAH
 LORD
 MERCIES
 NUMBER

PLAGUE
 SHEKELS
 SINNED
 THRESHING FLOOR

Enter Here to
 Purchase the
 Threshing Floor →

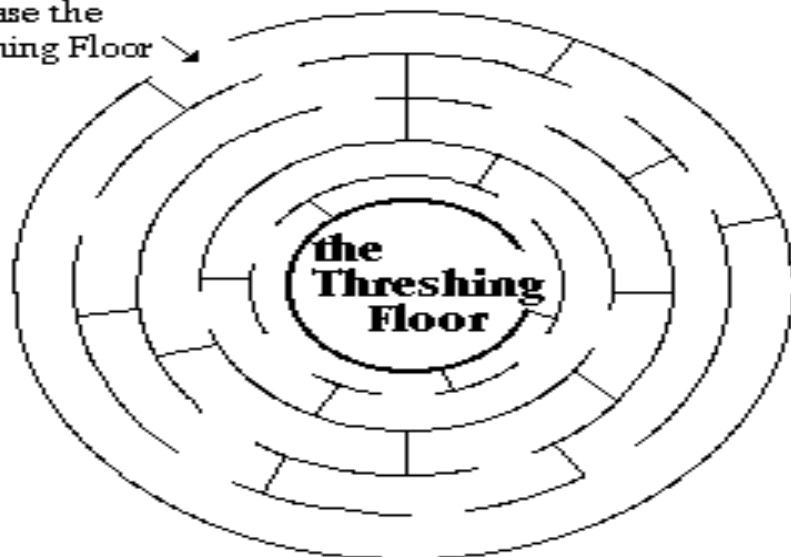

87. DAVID'S CENSUS, JUDGMENT AND PURCHASE OF THE THRESHING FLOOR (2 SAMUEL 24: 1-25)

MEMORY VERSE:

"Please let us fall into the hand of the LORD, for His mercies are great; but do not let me fall into the hand of man." 2 SAMUEL 24:14

TRUE OR FALSE:

1. "Again the anger of the LORD was aroused against Israel, and He moved David against them to say, 'Go, number Israel and Judah.' " **2 SAMUEL 24:1**
TRUE OR FALSE

FILL IN THE BLANKS:

2. "And _____ said to the king, 'Now may the LORD your God add to the people a hundredfold more than there are, and may the _____ of my lord the king see it. But _____ does my lord the king desire this thing?' "
2 SAMUEL 24:3

TRUE OR FALSE:

3. So Joab and the captains of the army did not go out from the presence of the king to count the people of Israel. **2 SAMUEL 24:4**
TRUE OR FALSE

FILL IN THE BLANKS:

4. "Then Joab gave the sum of the number of the people to the king. And there were in _____ eight hundred thousand valiant men who drew the sword, and the men of _____ were five hundred thousand men." **2 SAMUEL 24:9**

PUT AN X IN FRONT OF ALL THE CORRECT ANSWERS:

5. "And David's heart condemned him after he had numbered the people. So David said to the LORD,..." **2 SAMUEL 24:10**
____ "I have sinned greatly in what I have done"
____ "I pray, O LORD, take away the iniquity of Your servant"
____ "I have done very wisely"
____ "I have done very foolishly"

"Go and tell David, Thus says the LORD: "I offer you three things; choose one of them for yourself, that I may do it to you." ' " 2 SAMUEL 24:12

FILL IN THE BLANKS:

6. "David said to Gad, 'I am in great distress. Please let us fall into the hand of the LORD, for His _____ are great; but do not let me fall into the hand of man.' "
2 SAMUEL 24:14
7. "So the LORD sent a _____ upon Israel from the morning till the appointed time." **2 SAMUEL 24:15**
8. "And Gad came that day to David and said to him, 'Go up, erect an _____ to the LORD on the threshing floor of Araunah the Jebusite.' " **2 SAMUEL 24:18**

87. DAVID'S CENSUS, JUDGMENT AND PURCHASE OF THE THRESHING FLOOR

(2 SAMUEL 24:1-25)

P W G O I T F H J Q I U O T U L I C O U N T U V I
 O B W F G F I O N B S H K C H N D S B D I N T S A
 P D E N M E D N O C N E J K W L F E D R S U R V P
 K O N J R H H B M M P C B L B L J W J K J A D B P
 E T K M Y S O N B T P K S J O U M U E B E M I F E
 J U V P H S Y N B Y A K H T J T K Y D L Z Y N O L
 M O R E Z V P G N X G Q E N N R Z A X A I W F C O
 S W A U M Y V T A Z K M I A O B A I D C H K E O R
 F M N B C N C R Q Z P S M O T V N O L B E Q U C D
 I C Y S K B T N P Q E K I G Q H G N P T R A E H Y
 S L E K E H S Y T F I F M L Y O E M G H B O T W D
 J K T H R E S H I N G F L O O R L Z L V N I M S C
 T A C O U M J M W H Q S N V F C O M C H S N V E I
 O K V Q K H B E X S N O D N Q T F Q L I E G N I L
 L W B Z P Q M H R Y Y M X P K S T Y N R U E W C R
 Z T M A A C O B V G U Y V P G Y H N O B T L F R U
 F E F P I R N C A L T A R A U B E Y Q U B S M E L
 G S F I E J J P O I D K C C P D L O A B B A E M Y
 L B F G P L A G U E Y K B J M Q O V O D D I V A D
 B P N I K J K H U T G A B I B T R M V B Z V G H I
 S A D Z H B L J X H Z Y C M D B D Q J S R M Q E D
 N V F L Y V S J P A E P N W L L Y C T M H N I I N
 J H F P Z G U I S Y C M U C L B G G E G G D F E H
 O M Y S B F L Y J N N U M B E R V Q I O B A O J J
 U V O E R B I H G M M B I L B R O T Q V Z H B E M

ALTAR	DAVID	JOAB	NUMBER
ANGER	FIFTY SHEKELS	JUDAH	PLAGUE
ANGEL OF THE LORD	HEART	LORD	SINNED
CONDEMNED	ISRAEL	THRESHING FLOOR	MERCIES
COUNT			

Enter Here to
Purchase the
Threshing Floor



87. David's Census, Judgment and Purchase of the Threshing Floor (2 Samuel 24: 1-25)

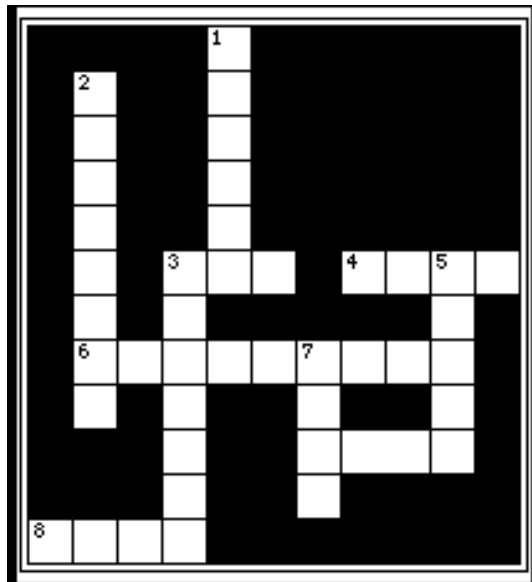

- 3 DOWN "Please let us fall into the hand of the LORD, for His _____ are great; but do not let me fall into the hand of man." **2 SAMUEL 24:14**
- 5 DOWN "Again the _____ of the LORD was aroused against Israel, and He moved David against them to say, 'Go, number Israel and Judah.'" **2 SAMUEL 24:1**
- 8 ACROSS "And Joab said to the king, 'Now may the LORD your God add to the people a hundredfold more than there are, and may the _____ of my lord the king see it. But why does my lord the king desire this thing?' " **2 SAMUEL 24:3**
- 4 ACROSS "So _____ and the captains of the army went out from the presence of the king to count the people of Israel." **2 SAMUEL 24:4**
- 3 ACROSS "Then Joab gave the sum of the number of the people to the king. And there were in Israel eight hundred thousand valiant _____ who drew the sword, and the men of Judah were five hundred thousand men." **2 SAMUEL 24:9**
- 2 DOWN "And David's heart condemned him after he had numbered the people. So David said to the LORD, 'I have sinned greatly in what I have done; but now, I pray, O LORD, take away the _____ of Your servant, for I have done very foolishly.'" **2 SAMUEL 24:10**
- 7 DOWN "David said to Gad, 'I am in great distress. Please let us fall into the _____ of the LORD, for His mercies are great; but do not let me fall into the hand of man.'" **2 SAMUEL 24:14**
- 1 DOWN "So the LORD sent a _____ upon Israel from the morning till the appointed time." **2 SAMUEL 24:15**
- 6 ACROSS "And Gad came that day to David and said to him, 'Go up, erect an altar to the LORD on the _____ floor of Araunah the Jebusite.'" **2 SAMUEL 24:18**

Bible Story 88

SOLOMON IS MADE KING

1 KINGS 1:28-53

88. SOLOMON IS MADE KING

(1 KINGS 1:28-53)



"And let Zadok the priest and Nathan the prophet anoint him there king over Israel:
and blow ye with the trumpet, and say, God save king Solomon."

1 KINGS 1:34

88. SOLOMON IS MADE KING (1 KINGS 1:28-53)

MEMORY VERSE:

"As the LORD has been with my lord the king, even so may He be with Solomon." 1 KINGS 1:37

CIRCLE THE CORRECT WORD:

1. Now Bathsheba came to David and "the king took an oath and said, 'As the LORD lives, who has redeemed my life from every distress, just as I swore to you by the LORD GOD of Israel, saying, "Assuredly Solomon your son shall be (**KING, IMPRISONED**) after me, and he shall sit on my throne in my place," so I certainly will do this day.' " 1 KINGS 1:29-30

TRUE OR FALSE:

2. "Then Bathsheba bowed with her face to the earth, and did homage to the king, and said, 'Let my lord King David live forever!' " 1 KINGS 1:31

TRUE OR FALSE

UNDERLINE THE CORRECT ANSWER:

3. "And King David said, 'Call to me...' " 1 KINGS 1:32
- a. Zadok the priest c. Benaiah the son of Jehoiada
b. Nathan the prophet d. all of the these

CIRCLE THE CORRECT WORDS:

4. "The king also said to them, 'Take with you the servants of your lord, and have (**SAUL, SOLOMON**) my son ride on my own mule, and take him down to Gihon.' " 1 KINGS 1:33
5. "Let Zadok the priest and Nathan the prophet (**PROCLAIM, ANOINT**) him king over Israel; and blow the horn, and say, 'Long live King Solomon!' " 1 KINGS 1:34
6. "Then you shall come up after him, and he shall come and sit on my throne, and he shall be king in my place. For I have appointed him to be (**RULER, JUDGE**) over Israel and Judah." 1 KINGS 1:35

FILL IN THE BLANKS:

7. And Benaiah said, "As the LORD has been with my lord the king, even so may He be with Solomon, and make his throne _____ than the throne of my lord King David." 1 KINGS 1:37
8. "Then Zadok the priest took a horn of oil from the tabernacle and anointed Solomon. And they blew the horn, and _____ the people said, 'Long live King Solomon!' " 1 KINGS 1:39

88. SOLOMON IS MADE KING

(1 KINGS 1:28-53)

G R E A T E R N V B
T H R O N E P B A K
H A I A N E B T N O
K I N G O B H A O D
H E S I W S T I I A
L K L H H H T R N Z
A G O E A T C U T W
Z R B N O M O L O S
N A D A V I D E G Z
Y Z B E G D P R U E

ANOINT
BATHSHEBA
BENAIAH
DAVID
ZADOK

GREATER
HORN
KING
NATHAN

OIL
RULER
SOLOMON
THRONE

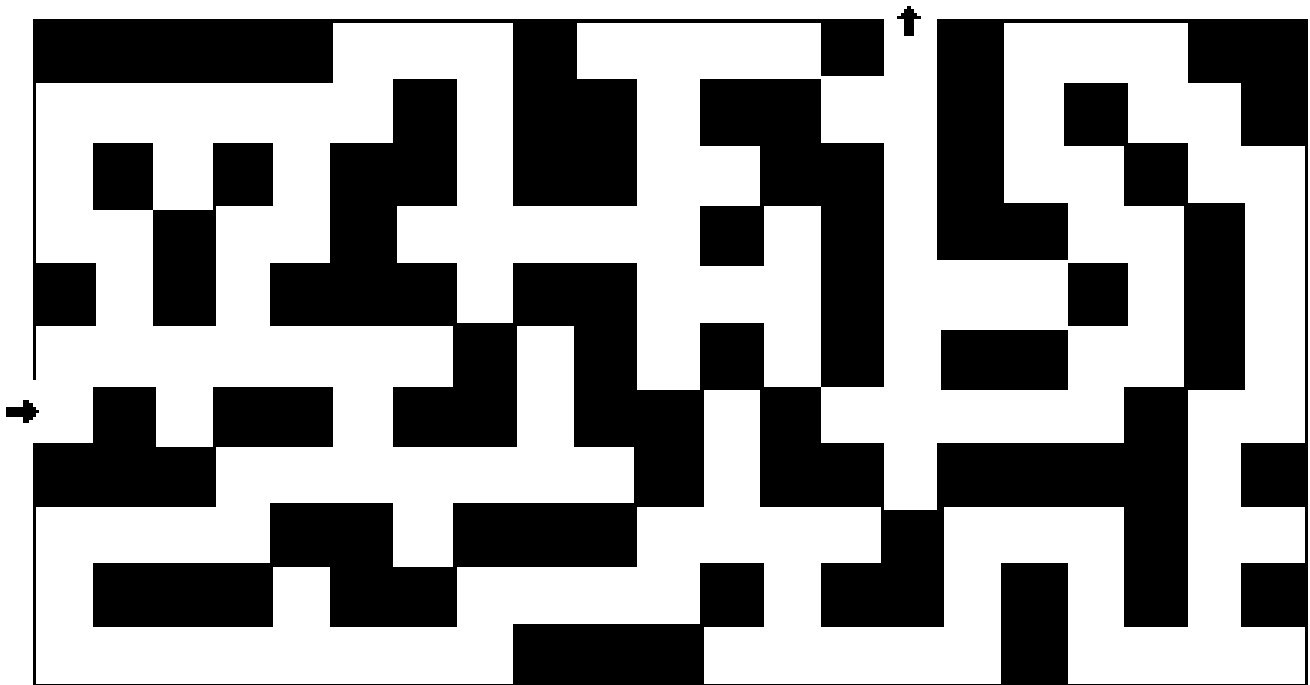

88. SOLOMON IS MADE KING (1 KINGS 1:28-53)

MEMORY VERSE:

"As the LORD has been with my lord the king, even so may He be with Solomon." 1 KINGS 1:37

FILL IN THE BLANK:

1. Now Bathsheba came to David and "the king took an oath and said, 'As the LORD lives, who has redeemed my life from every distress, just as I swore to you by the LORD GOD of Israel, saying, "Assuredly Solomon your son shall be _____ after me, and he shall sit on my throne in my place," so I certainly will do this day.' " **1 KINGS 1:29-30**

TRUE OR FALSE:

2. "Then Bathsheba bowed with her face to the earth, and did homage to the king, and said, 'Let my lord King David live forever!' " **1 KINGS 1:31**
TRUE OR FALSE

UNDERLINE THE CORRECT ANSWER:

3. "And King David said, 'Call to me...' " **1 KINGS 1:32**
a. Zadok the priest c. Benaiah the son of Jehoiada
b. Nathan the prophet d. all of the these

FILL IN THE BLANKS:

4. "The king also said to them, 'Take with you the servants of your lord, and have _____ my son ride on my own mule, and take him down to Gihon.' " **1 KINGS 1:33**
5. "Let Zadok the priest and Nathan the prophet _____ him king over Israel; and blow the horn, and say, 'Long live King Solomon!' " **1 KINGS 1:34**
6. "Then you shall come up after him, and he shall come and sit on my throne, and he shall be king in my place. For I have appointed him to be _____ over Israel and Judah." **1 KINGS 1:35**
7. And Benaiah said, "As the LORD has been with my lord the king, even so may He be with Solomon, and make his throne _____ than the throne of my lord King David." **1 KINGS 1:37**
8. "Then Zadok the priest took a horn of oil from the tabernacle and anointed Solomon. And they blew the horn, and _____ the people said, 'Long live King Solomon!' " **1 KINGS 1:39**

88. SOLOMON IS MADE KING (1 KINGS 1:28-53)

U Y S V X O Q T Z A C X P Y I G C O Y A
 Y K N N W A J N Z N U N N B A C H A X D
 Y P B G E V N D N A N O I N T Z R K D D
 R U N G B C I A K F J A K B G H E U N W
 N I K D L A C R H T K Y B P W K M N B T
 K Y K P V A T A O T S Q C P E N O R H T
 H N O K D L T H B Q A U D B A K Q U E L
 E K J S D O C Z S H M N W E N N N D H A
 L T Q P Z Z J E R H J Q K N U O Y L T O
 M G S P Z M W M H E E T I A T M M O I L
 G Z P R O F Y D N A L B E I O O A U L A
 M E A X W G J W V U T U A A M L S N U P
 B Y M D H M R Q I U A H R H J O V L W A
 P G B O O Q T E N R O H D Y K S Y Y Q D
 M M B S Q K N N A T A T I N G R K H N Y
 W Q O L I S A I O T U T V O H E W X I S
 N H H K L Q S T N T E R A J G N L O S M
 G V S W H V L A H D E R D W D C W I V U
 K V S V T P P L I D N R P S V V W R U L
 B G R J Y B U B U Q Q W I S B C Z N U S

ANOINT
 BATHSHEBA
 BENAIAH
 DAVID
 GREATER

HORN
 KING
 NATHAN
 OIL

RULER
 SOLOMON
 THRONE
 ZADOK

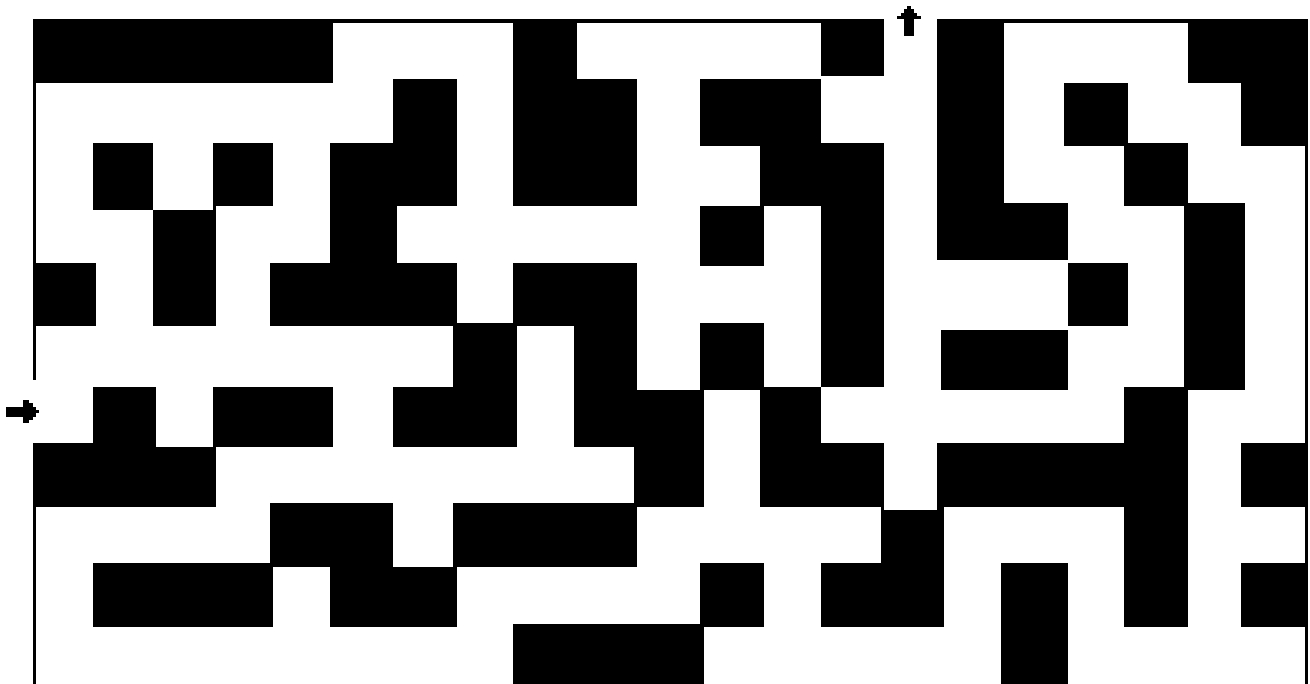

88. SOLOMON IS MADE KING

(1 KINGS 1:28-53)

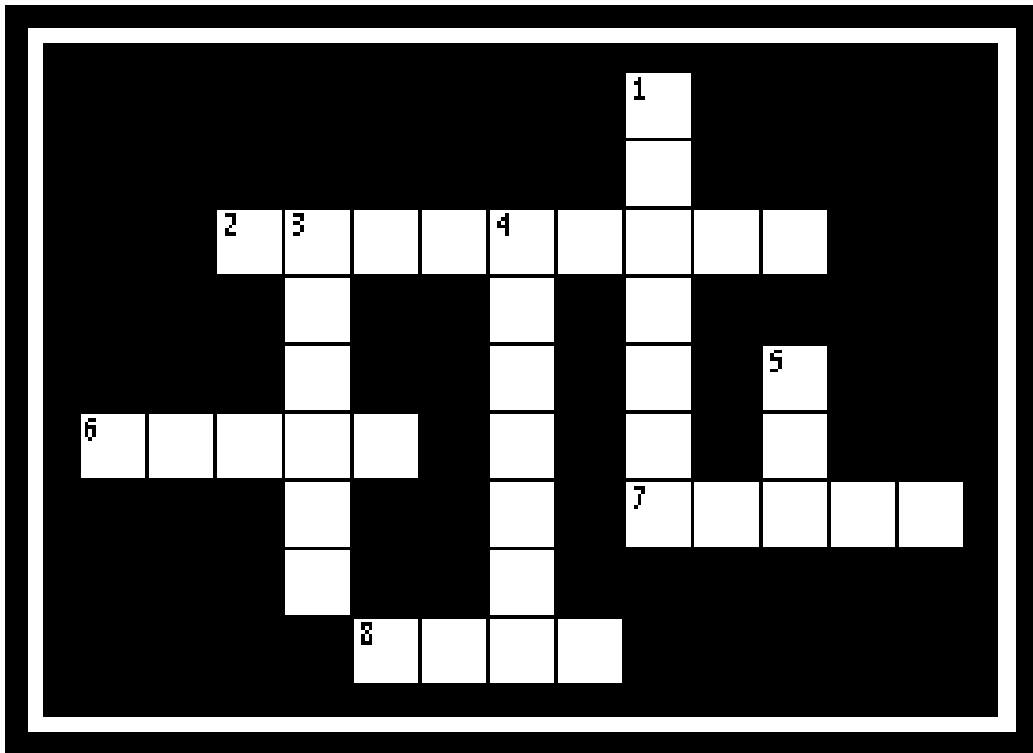

- 8 ACROSS "Solomon your son shall be _____ after me, and he shall sit on my throne in my place," so I certainly will do this day." **1 KINGS 1:30**
- 2 ACROSS "Then _____ bowed with her face to the earth, and did homage to the king, and said, 'Let my lord King David live forever!' " **1 KINGS 1:31**
- 6 ACROSS "And King _____ said, 'Call to me Zadok the priest, Nathan the prophet, and Benaiah the so of Jehoiada.' So they came before the king." **1 KINGS 1:32**
- 4 DOWN "The king also said to them, 'Take with you the servants of your lord, and have _____ my son ride on my own mule, and take him down to Gihon.' " **1 KINGS 1:33**
- 3 DOWN "Let Zadok the priest and Nathan the prophet _____ him king over Israel; and blow the horn, and say, 'Long live King Solomon!' " **1 KINGS 1:34**
- 7 ACROSS "Then you shall come up after him, and he shall come and sit on my throne, and he shall be king in my place. For I have appointed him to be _____ over Israel and Judah." **1 KINGS 1:35**
- 1 DOWN And Benaiah said, "As the LORD has been with my lord the king, even so may He be with Solomon, and make his throne _____ than the throne of my lord King David." **1 KINGS 1:37**
- 5 DOWN "Then Zadok the priest took a horn of _____ from the tabernacle and anointed Solomon. And they blew the horn, and all the people said, 'Long live King Solomon!' " **1 KINGS 1:39**

Bible Story 89

**SOLOMON ASKS
GOD FOR WISDOM**

1 KINGS 3:3-14

89. SOLOMON ASKS GOD FOR WISDOM (1 KINGS 3:3-14)



"In Gibeon the LORD appeared to Solomon in a dream by night: and God said, Ask what I shall give thee."
1 KINGS 3:5

"Give therefore thy servant an understanding heart to judge thy people, that I may discern between good and bad: for who is able to judge this thy so great a people?" **1 KINGS 3:9**

89. SOLOMON ASKS GOD FOR WISDOM

(1 KINGS 3:3-14)

MEMORY VERSE:

"And Solomon loved the LORD, walking in the statutes of his father David." 1 KINGS 3:3

TRUE OR FALSE:

1. "Solomon loved the LORD, walking in the statutes of his father David, except that he sacrificed and burned incense at the high places." 1 KINGS 3:3
TRUE OR FALSE

FILL IN THE BLANKS:

2. "At Gibeon the LORD appeared to Solomon in a dream by night; and God said, 'Ask! What shall I _____ you?' " 1 KINGS 3:5
3. Solomon said to the LORD, "_____ servant is in the midst of _____ people whom You have chosen, a great people, too numerous to be numbered or counted." 1 KINGS 3:8

CIRCLE THE CORRECT WORD:

4. "Therefore give to Your servant an (**UNDERSTANDING, HARDENED**) heart to judge Your people, that I may discern between good and evil. For who is able to judge this great people of Yours?" 1 KINGS 3:9

TRUE OR FALSE:

5. But the speech displeased the LORD, that Solomon had asked this thing. 1 KINGS 3:10
TRUE OR FALSE

CIRCLE THE CORRECT WORDS:

6. The LORD said to Solomon, "Behold, I have done according to your words; see, I have given you a (**WISE, FOOLISH**) and (**UNDERSTANDING, HARDENED**) heart, so that there has not been anyone like you before you, nor shall any like you arise after you." 1 KINGS 3:12
7. Then the LORD said, "And I have also given you what you have not asked: both (**SONG AND DANCE, RICHES AND HONOR**), so that there shall not be anyone like you among the kings all your days." 1 KINGS 3:13
8. Finally, the LORD said, "So if you walk in (**MY, YOUR**) ways, to keep (**MY, YOUR**) statutes and (**MY, YOUR**) commandments, as your father David walked, then I will lengthen your days." 1 KINGS 3:14

89. SOLOMON ASKS FOR WISDOM

(1 KINGS 3:3-14)

C O M M A N D M E N T S T G U
H E A R T I U O B K R D N N P
N L Q O A E J V L O R U D O G
W S U O R E M U N M A E R D G
D E J F S G L O L Y R V B J D
I T J U P W H Y D S O C K M E
S U G D D R O L T D W G L N S
E T B I W K J A I Y H O D R A
H A V V D O N V N E J Q O M E
C T D E J D A B K H S A H I L
I S V E I D T N O M O L O S P
R O I N H I B C A L R E Y F L
L O G M N L V J U K L A W J Y
C P M N F D E S I W V G Q Q T
P D O B G S Q N W B J A K E P

COMMANDMENTS

LORD

STATUTES

DAVID

LOVED

UNDERSTANDING

DREAM

PLEASED

WALK

HEART

RICHES

WISE

HONOR

SOLOMON

NUMEROUS

89. Solomon Asks God for Wisdom

(1 Kings 3:3-14)

MEMORY VERSE:

"And Solomon loved the LORD, walking in the statutes of his father David." 1 KINGS 3:3

TRUE OR FALSE:

1. "Solomon loved the LORD, walking in the statutes of his father David, except that he sacrificed and burned incense at the high places." 1 KINGS 3:3
TRUE OR FALSE

FILL IN THE BLANKS:

2. "At Gibeon the LORD appeared to Solomon in a dream by night; and God said, 'Ask! What shall I _____ you?' " 1 KINGS 3:5
3. Solomon said to the LORD, " _____ servant is in the midst of _____ people whom You have chosen, a great people, too numerous to be numbered or counted." 1 KINGS 3:8
4. "Therefore give to Your servant an understanding _____ to judge Your people, that I may discern between good and evil. For who is able to judge this great people of Yours?" 1 KINGS 3:9

TRUE OR FALSE:

5. But the speech displeased the LORD, that Solomon had asked this thing. 1 KINGS 3:10
TRUE OR FALSE

FILL IN THE BLANKS:

6. The LORD said to Solomon, "Behold, I have done according to your words; see, I have given you a _____ and _____ heart, so that there has not been anyone like you before you, nor shall any like you arise after you." 1 KINGS 3:12
7. Then the LORD said, "And I have also given you what you have not asked: both _____ and _____, so that there shall not be anyone like you among the kings all your days." 1 KINGS 3:13
8. Finally, the LORD said, "So if you walk in _____ ways, to keep _____ statutes and _____ commandments, as your father David walked, then I will lengthen your days." 1 KINGS 3:14

89. SOLOMON ASKS FOR WISDOM

(1 KINGS 3:3-14)

J H K W L H P U Y L P M O S F H J U M R
U H E X D U R D Z W N H J T L I V U I X
M Q Y Y F S F W U C S Y Q V K P H C G V
N U T L D Y M E G A C Y L G I K H I Q D
B P E R A J E N O M O L O S Q E P X W I
D U E H B N T W A L K C P W S R L Q G M
C A Z E R G L E F Z O M L D S E E B X O
M M Q A H O N O R M N O V K S N A V W O
Z N V R X D M I M S R B G A O A S B D F
R V L T E Y E A D D P P Y G E T E W I U
D S S N W I N B Y N C R Q S A I D Y C D
Y L R D G D Z D I D A Y D T Z P Y U P I
Q D S C M B I V F G X T U A P Q G K L V
Q B A E F L I N B P C T S U E R M Y O E
H M N V Z O D P L C E R O R U R R H P M
D T B V I U Z Y A S N E O M E C U R D W
S E B O A D S U O R E M U N V D V Q Q I
F I V S N P P G E V P N M S F G N X J S
O O Z O S W Z N Z U R V P Y I O E U J E
I X F K L C V W C I E T Z X U W Z H C N

COMMANDMENTS

LORD

STATUTES

DAVID

LOVED

UNDERSTANDING

DREAM

PLEASED

WALK

HEART

RICHES

WISE

HONOR

SOLOMON

NUMEROUS

89. SOLOMON ASKS GOD FOR WISDOM

(1 KINGS 3:3-14)

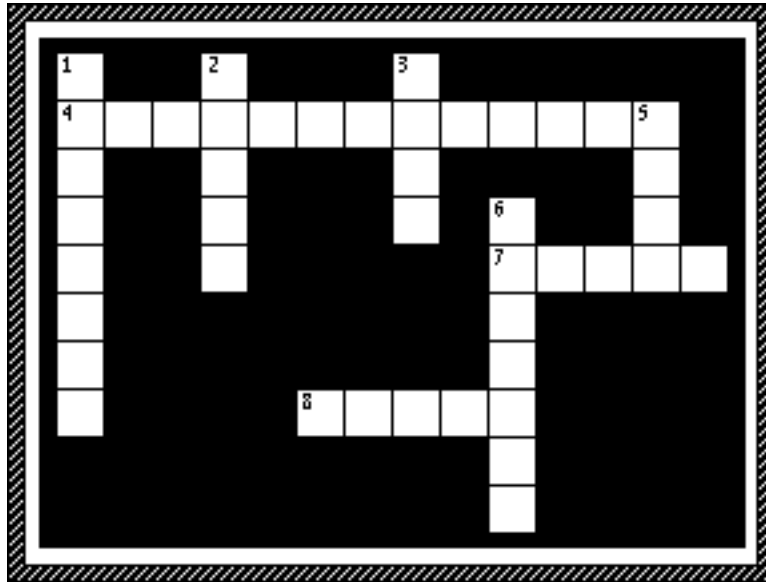

- 7 ACROSS "Solomon _____ the LORD, walking in the statutes of his father David, except that he sacrificed and burned incense at the high places." **1 KINGS 3:3**
- 5 DOWN "At Gibeon the LORD appeared to Solomon in a dream by night; and God said, 'Ask! What shall I _____ you?' " **1 KINGS 3:5**
- 1 DOWN Solomon said to the LORD, "Your servant is in the midst of Your people whom You have chosen, a great people, too _____ to be numbered or counted." **1 KINGS 3:8**
- 4 ACROSS "Therefore give to Your servant an _____ heart to judge Your people, that I may discern between good and evil." **1 KINGS 3:9**
- 6 DOWN "And the speech _____ the LORD, that Solomon had asked this thing." **1 KINGS 3:10**
- 2 DOWN The LORD said to Solomon, "Behold, I have done according to your words; see, I have given you a wise and understanding _____, so that there has not been anyone like you before you, nor shall any like you arise after you." **1 KINGS 3:12**
- 8 ACROSS Then the LORD said, "And I have also given you what you have not asked: both riches and honor, so that there shall not be anyone like you among the _____ all your days." **1 KINGS 3:13**
- 3 DOWN Finally, the LORD said, "So if you _____ in My ways, to keep My statutes and My commandments, as your father David walked, then I will lengthen your days." **1 KINGS 3:14**

Bible Story 90

THE WISDOM OF SOLOMON

1 KINGS 3:16-28; 4:21-34

90. THE WISDOM OF SOLOMON

(1 KINGS 3:16-28; 4:21-34)



"Then spake the woman whose the living child *was* unto the king, for her bowels yearned upon her son, and she said, O my lord, give her the living child, and in no wise slay it. But the other said, Let it be neither mine nor thine, *but divide it.*"

1 KINGS 3:26

90. THE WISDOM OF SOLOMON

(1 KINGS 3:16-28; 4:21-34)

MEMORY VERSE:

"Thus Solomon's wisdom excelled the wisdom of all the men of the East and all the wisdom of Egypt." 1 KINGS 4:30

TRUE OR FALSE:

1. Two women "came to the king, and stood before him. And one woman said, 'O my lord, this woman and I dwell in the same house; and I gave birth while she was in the house.' " **1 KINGS 3:16-17**
TRUE OR FALSE
2. "Then it happened, the third day after I had given birth, that this woman also gave birth." **1 KINGS 3:18**
TRUE OR FALSE

FILL IN THE BLANK:

3. "And this woman's son _____ in the night, because she lay on him." **1 KINGS 3:19**

CIRCLE THE CORRECT WORD:

4. "So she arose in the middle of the night and took my son from my side, while your maidservant (**WEPT, SLEPT**), and laid him in her bosom, and laid her dead child in my bosom." **1 KINGS 3:20**

TRUE OR FALSE:

5. "The other woman said, 'No! But the living one is my son, and the dead one is your son.' " **1 KINGS 3:22**
TRUE OR FALSE
6. The king said, "Bring me a pen." So they brought a pen before the king. **1 KINGS 3:24**
TRUE OR FALSE
7. Then "the king said, 'Divide the living child in two, and give half to one, and half to the other.' " **1 KINGS 3:25**
TRUE OR FALSE

CIRCLE THE CORRECT WORDS:

8. "Then the woman whose son was living spoke to the king, for she yearned with compassion for her son; and she said, 'O my lord, give her the living child, and by (**NO, ANY**) means kill him!' " **1 KINGS 3:26**
9. "But the other said, 'Let him be neither mine nor yours, but (**THE KING'S, DIVIDE HIM**).' " **1 KINGS 3:26**
10. "So the king answered and said, 'Give the first woman the living child, and by no means kill him; she is his (**MOTHER, FRIEND**).' " **1 KINGS 3:27**
11. "He spoke three thousand (**PROVERBS, VERBS**), and his songs were one thousand and five." **1 KINGS 3:32**
12. "And men of all nations, from all the kings of the earth who had heard of his (**RICHES, WISDOM**), came to hear the wisdom of Solomon." **1 KINGS 4:34**

90. THE WISDOM OF SOLOMON

(1 KINGS 3:16-28; 4:21-34)

K Z O M J Y U M Z O A K A Q W
W O A D R W S O L O M O N T K
V E E C I E T D Z N U S A H I
J I D S O J H W N H H T R I B
D W D I I M N T K I U M U T E
X O V Q V T P Q O U T S E T P
M H C S C I D A O M T B N R I
W Q A S O N D N S A D R Q R Y
E L L Q T N R I B S D E N W B
L I I V C A G T H F I V N P B
V L O V W S A S S O N O A N P
D H Z P I O Z A F F Q R N K P
D T M B J N M L V T C P Y B Y
S W O R D L G E I Q U J Q C F
Z Y F Q W P E B N H J T U D O

BIRTH
COMPASSION
DIED
DIVIDE
LIVING

MOTHER
PROVERBS
SOLOMON
SONGS

SON
SWORD
WISDOM
WOMEN

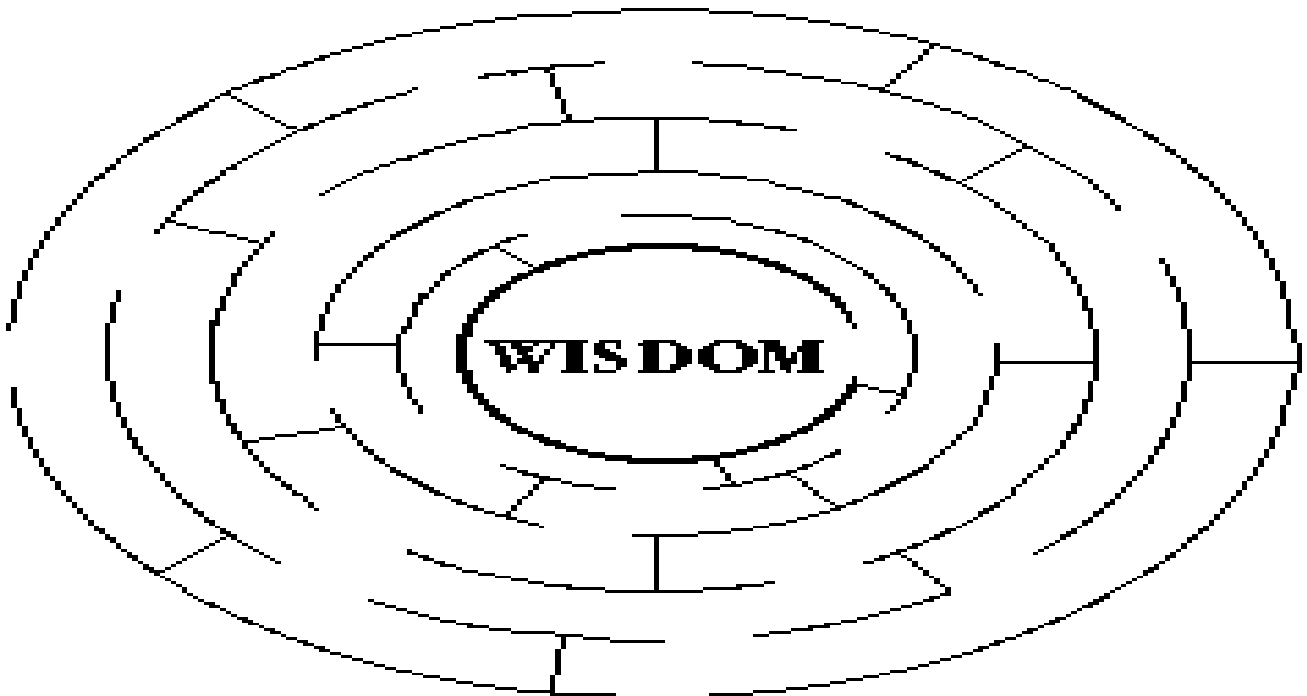

90. THE WISDOM OF SOLOMON

(1 KINGS 3:16-28; 4:21-34)

MEMORY VERSE:

"Thus Solomon's wisdom excelled the wisdom of all the men of the East and all the wisdom of Egypt." 1 KINGS 4:30

TRUE OR FALSE:

1. Two women "came to the king, and stood before him. And one woman said, 'O my lord, this woman and I dwell in the same house; and I gave birth while she was in the house.'" 1 KINGS 3:16-17
TRUE OR FALSE
2. "Then it happened, the third day after I had given birth, that this woman also gave birth." 1 KINGS 3:18
TRUE OR FALSE

FILL IN THE BLANKS:

3. "And this woman's son _____ in the night, because she lay on him." 1 KINGS 3:19
4. "So she arose in the middle of the night and took my son from my side, while your maidservant _____, and laid him in her bosom, and laid her dead child in my bosom." 1 KINGS 3:20

TRUE OR FALSE:

5. "The other woman said, 'No! But the living one is my son, and the dead one is your son.'" 1 KINGS 3:22
TRUE OR FALSE
6. The king said, "Bring me a pen." So they brought a pen before the king. 1 KINGS 3:24
TRUE OR FALSE
7. Then "the king said, 'Divide the living child in two, and give half to one, and half to the other.'" 1 KINGS 3:25
TRUE OR FALSE

FILL IN THE BLANKS:

8. "Then the woman whose son was living spoke to the king, for she yearned with compassion for her son; and she said, 'O my lord, _____ her the living child, and by no means kill him!' " 1 KINGS 3:26
9. "But the other said, 'Let him be neither mine nor yours, but _____ him.'" 1 KINGS 3:26
10. "So the king answered and said, 'Give the first woman the living child, and by no means kill him; she is his _____.'" 1 KINGS 3:27
11. "Thus Solomon's wisdom _____ the wisdom of all the men of the East and all the wisdom of Egypt." 1 KINGS 4:30
12. Solomon "spoke three thousand _____, and his songs were one thousand and five." 1 KINGS 3:32
13. "And men of all nations, from all the kings of the earth who had heard of his _____, came to hear the wisdom of Solomon." 1 KINGS 4:34

90. THE WISDOM OF SOLOMON

(1 KINGS 3:16-28; 4:21-34)

Q L M S B R E V O R P P S W I G P R L Y
F Q G I V Q O N C N H H Q G S R A E D B
D K E F M J N Y P Y O B U G S R D B K P
N E W L Y O V D L U H S N G X I U I G B
G K K G M X L H R K O O Z V V K Y D C N
V H R O A B C I Z S S P F I W U E A B Y
G Y L H T R I B P S F P D B J P D M B Q
K O G X J H E I C V B Y L I V I N G V Q
S X U Y R Z G A O Y X J N I F S K D K F
Z J J V O S V L M Z Z V M F D Q J I G E
D V A Z W Y T N P N G T F X K I Y R V Z
I I H O M Q Y F A O F C I L G V E G E H
Y E R Y Q P E R S W N V E Y A Y Z D A F
N D P M D V R D S K C S V E Z E W K B M
A A R O T M B K I I N H M Q I Z I F Y C
P A M T O V W S O Z Z D N T N N S Q Z G
N Q A H U O I F N A A L I X T E D N R J
A X U E C T B X D A K H M B S M O I Q O
W P L R H J U Y H W I Z J K Y O M G V X
Q F M U E Z W D M C L E C S T W Y J E F

BIRTH
COMPASSION
DIED
DIVIDE
LIVING

MOTHER
PROVERBS
SOLOMON
SONGS

SON
SWORD
WISDOM
WOMEN

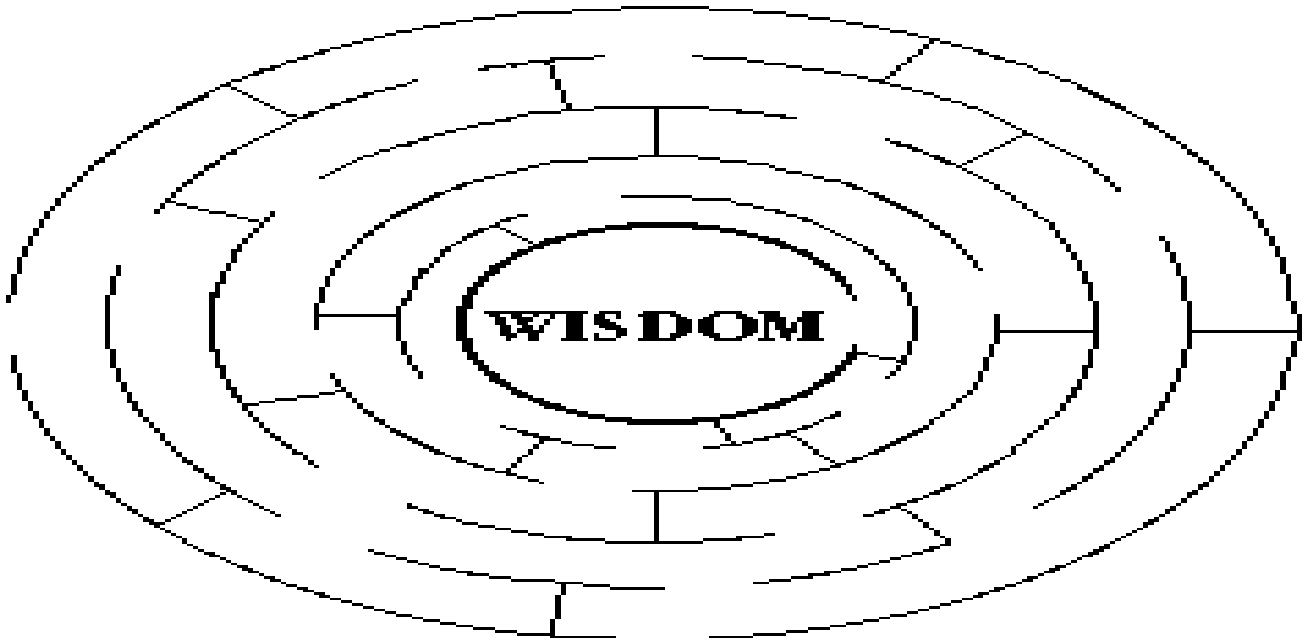

90. THE WISDOM OF SOLOMON

(1 KINGS 3:16-28; 4:21-34)

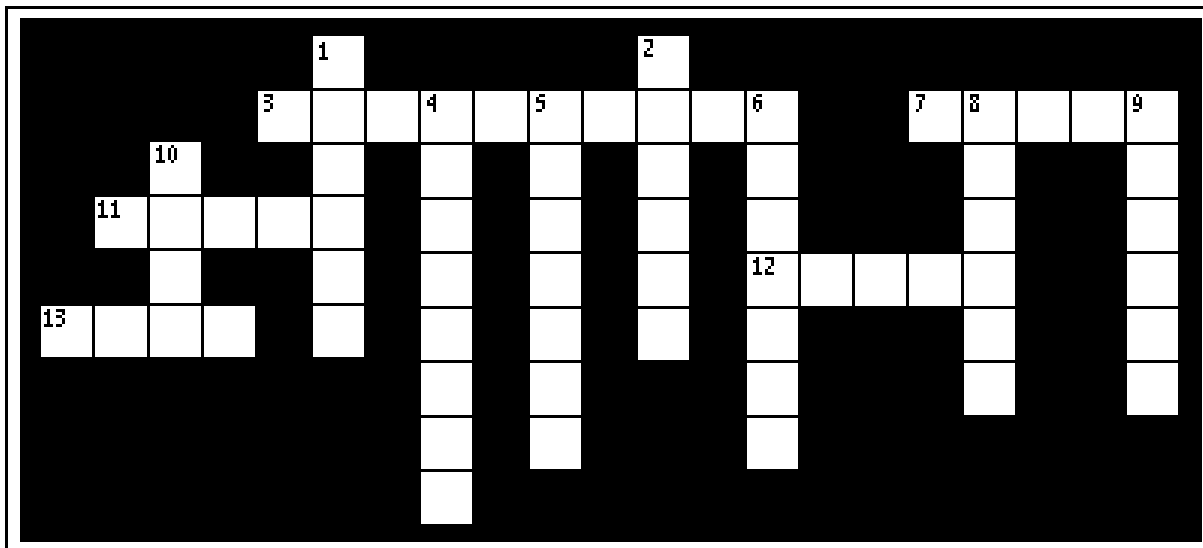

- 11 ACROSS "And one woman said,'O my lord, this woman and I dwell in the same house; and I gave _____ while she was in the house.'" **1 KINGS 3:16-17**
- 12 ACROSS "Then it happened, the _____ day after I had given birth, that this woman also gave birth." **1 KINGS 3:18**
- 10 DOWN "And this woman's son _____ in the night, because she lay on him." **1 KINGS 3:19**
- 13 ACROSS "So she arose in the middle of the night and took my son from my _____, while your maidservant slept." **1 KINGS 3:20**
- 2 DOWN "The other woman said, 'No! But the _____ one is my son, and the dead one is your son.'" **1 KINGS 3:22**
- 7 ACROSS "The king said, 'Bring me a _____.'" **1 KINGS 3:24**
- 9 DOWN Then "the king said, '_____ the living child in two, and give half to one, and half to the other.'" **1 KINGS 3:25**
- 3 ACROSS "Then the woman whose son was living spoke to the king, for she yearned with _____ for her son; and she said, 'O my lord, give her the living child, and by no means kill him!'" **1 KINGS 3:26**
- 6 DOWN "But the other said, 'Let him be _____ mine nor yours, but divide him.'" **1 KINGS 3:26**
- 1 DOWN "So the king answered and said, 'Give the first woman the living child, and by no means kill him; she is his _____.'" **1 KINGS 3:27**
- 4 DOWN "He spoke three thousand _____, and his songs were one thousand and five." **1 KINGS 3:32**
- 8 DOWN "Thus Solomon's _____ excelled the wisdom of all the men of the East and all the wisdom of Egypt." **1 KINGS 4:30**
- 5 DOWN "And men of all nations, from all the kings of the earth who had heard of his wisdom, came to hear the wisdom of _____." **1 KINGS 4:34**

Bible Story 91

**SOLOMON BUILDS
THE TEMPLE**

1 KINGS 6:1-38

91. SOLOMON BUILDS THE TEMPLE

(1 KINGS 6:1-38)



"And it came to pass in the four hundred and eightieth year after the children of Israel were come out of the land of Egypt, in the fourth year of Solomon's reign over Israel, in the month Zif, which *is* the second month, that he began to build the house of the LORD."

1 KINGS 6:1

91. SOLOMON BUILDS THE TEMPLE

(1 KINGS 6:1-38)

MEMORY VERSE:

"And I will dwell among the children of Israel, and will not forsake My people Israel." 1 KINGS 6:13

FILL IN THE BLANK:

1. "And it came to pass in the four hundred and eightieth year after the children of Israel had come out of the land of Egypt, in the fourth year of Solomon's reign over Israel, in the month of Ziv, which is the second month, that he began to build the _____ of the LORD." 1 KINGS 6:1

CIRCLE THE CORRECT WORDS:

2. "And the temple, when it was being built, was built with stone finished at the quarry, so that no hammer or chisel or any iron tool was **(HEARD, SEEN)** in the temple while it was being built." 1 KINGS 6:7
3. "So he built the temple and finished it, and he paneled the temple with beam and boards of **(PINE, CEDAR)**." 1 KINGS 6:9

TRUE OR FALSE:

4. "Then he built the twenty-cubit room at the rear of the temple, from floor to ceiling, with cedar boards; he built it inside as the inner sanctuary, as the Most Holy Place." 1 KINGS 6:16
TRUE OR FALSE
5. "And he prepared the inner sanctuary inside the temple, to set the ark of the covenant of the LORD there." 1 KINGS 6:19
TRUE OR FALSE
6. "The whole temple he overlaid with gold, until he had finished all the temple." 1 KINGS 6:22
TRUE OR FALSE
7. "Inside the inner sanctuary he made two cherubim of olive wood." 1 KINGS 6:23
TRUE OR FALSE

FILL IN THE BLANK:

8. "Also he overlaid the cherubim with _____." 1 KINGS 6:28

CIRCLE THE CORRECT WORDS:

9. "Then he **(CRACKED, CARVED)** all the walls of the temple all around, both the inner and outer sanctuaries, with carved figures of cherubim, palm trees, and open flowers." 1 KINGS 6:29
10. "And the floor of the temple he overlaid with **(SILVER, GOLD)**, both the inner and outer sanctuaries." 1 KINGS 6:30
11. "For the entrance of the inner sanctuary he made doors of **(OLIVE, GRAPE)** wood." 1 KINGS 6:31
12. "And he built the inner court with three rows of hewn **(STICKS, STONE)** and a row of cedar beams." 1 KINGS 6:36

TRUE OR FALSE:

13. And Solomon was seventy years in building the temple. 1 KINGS 6:38
TRUE OR FALSE

91. SOLOMON BUILDS THE TEMPLE

(1 KINGS 6:1-38)

N Y Q T O O L U I Q H U U H L
 C R D K C S H O U S E U K M O
 B E O E W Y S V P F Y I Y G P
 P L D P D D O O W E V I L O D
 R A O Z S S O L O M O N H Q Q
 R V Y S C R S F K R G X F W E
 E T R T K H A I R C M Q Q N J
 M O A B A M E E E G N B O G J
 H J U U G F O R Y O U T E J C
 Y Q T I D L E K U N S V L W X
 Y L C L S E Z R N B E B P D V
 M P N D A K V A A W I V M I G
 B V A V U I P R I J V M E C O
 P G S G K Q E U A V E W T S L
 R Y R O O L F H P C Z Y R P D

ARK
 BUILD
 CARVED
 CEDAR
 CHERUBIM

FLOOR
 GOLD
 HOUSE
 OLIVE WOOD
 SANCTUARY

SEVEN YEARS
 SOLOMON
 STONE
 TEMPLE
 TOOL

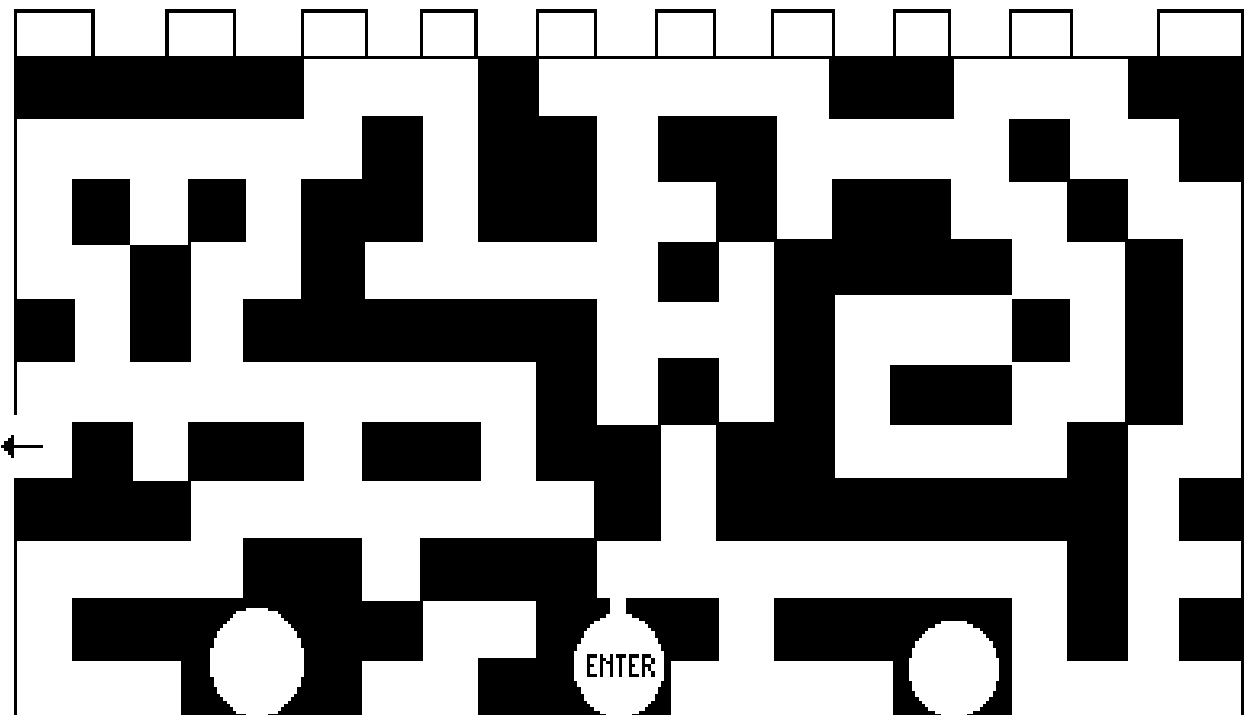

91. SOLOMON BUILDS THE TEMPLE

(1 KINGS 6:1-38)

MEMORY VERSE:

"And I will dwell among the children of Israel, and will not forsake My people Israel." 1 KINGS 6:13

FILL IN THE BLANKS:

1. "And it came to pass in the four hundred and eightieth year after the children of Israel had come out of the land of Egypt, in the fourth year of Solomon's reign over Israel, in the month of Ziv, which is the second month, that he began to build the _____ of the LORD." 1 KINGS 6:1
2. "And the temple, when it was being built, was built with stone finished at the quarry, so that no hammer or chisel or any iron tool was _____ in the temple while it was being built." 1 KINGS 6:7
3. "So he built the temple and finished it, and he paneled the temple with beam and boards of _____." 1 KINGS 6:9

TRUE OR FALSE:

4. "Then he built the twenty-cubit room at the rear of the temple, from floor to ceiling, with cedar boards; he built it inside as the inner sanctuary, as the Most Holy Place." 1 KINGS 6:16
TRUE OR FALSE
5. "And he prepared the inner sanctuary inside the temple, to set the ark of the covenant of the LORD there." 1 KINGS 6:19
TRUE OR FALSE
6. "The whole temple he overlaid with gold, until he had finished all the temple." 1 KINGS 6:22
TRUE OR FALSE
7. "Inside the inner sanctuary he made two cherubim of olive wood." 1 KINGS 6:23
TRUE OR FALSE

FILL IN THE BLANKS:

8. "Also he overlaid the cherubim with _____." 1 KINGS 6:28
9. "Then he _____ all the walls of the temple all around, both the inner and outer sanctuaries, with carved figures of cherubim, palm trees, and open flowers." 1 KINGS 6:29
10. "And the _____ of the temple he overlaid with gold, both the inner and outer sanctuaries." 1 KINGS 6:30
11. "For the entrance of the inner sanctuary he made doors of _____ wood." 1 KINGS 6:31
12. "And he built the inner court with three rows of hewn _____ and a row of cedar beams." 1 KINGS 6:36

TRUE OR FALSE:

13. And Solomon was seventy years in building the temple. 1 KINGS 6:38
TRUE OR FALSE

91. SOLOMON BUILDS THE TEMPLE

(1 KINGS 6:1-38)

D R E W S M W L C H V L J L K R N L N H
M C S Q B K L F W R J U N V Y H G W F F
O Q A S I T K N D V Z K G O D G G U S L
Z F N D P B I Q C I A U A S L J V V P I
E Y C E U D B Y V H D P R C I H E W C R
X M T D C B A K S H S A E T U D I H H A
L C U U E N K R R R E T S Z B H T O E F
V E A S U L S V Q Y D H E O S P R A R L
Q T R N L V R U N P Z E N O T S V H U O
O G Y J R V N E B Z W S Q E S N I S B O
C I N M M F V P C J G D P P D W O K I R
T A R S T E W F T F Z D O J E L K M M M
N E R K S W C E D A R M A O O Q D G A Z
W T M V E G D X C J A B B M W A D S L W
H Z F P E L L A N W R U O Z H E O W G J
W Q X H L D O Q L Q K N P J A V V N M Z
D Y P P A E G X O U H O U S E U C I H G
H H A K D C H P Z J Y H S H R D J P L V
M Q F J L O O T Y N T Q T F O L A N D O
J S N G E Z K U S N R O Y R T Z S R B Z

ARK
BUILD
CARVED
CEDAR
CHERUBIM

FLOOR
GOLD
HOUSE
OLIVE WOOD
SANCTUARY

SEVEN YEARS
SOLOMON
STONE
TEMPLE
TOOL

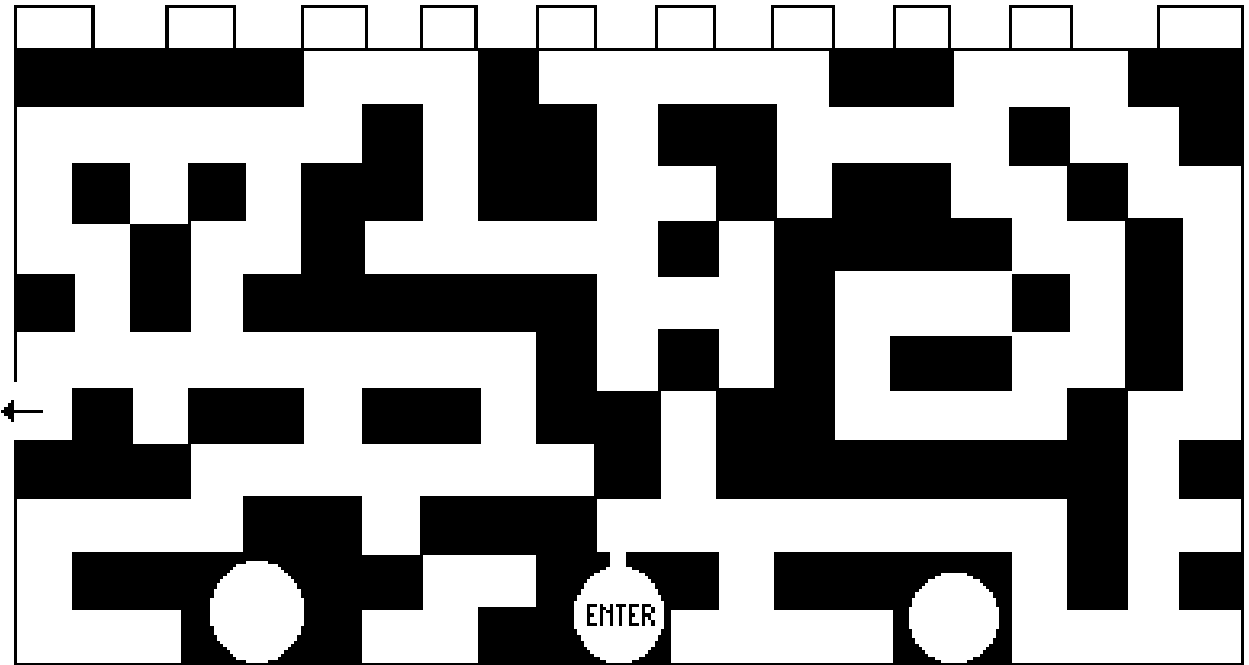

91. SOLOMON BUILDS THE TEMPLE

(1 KINGS 6:1-38)

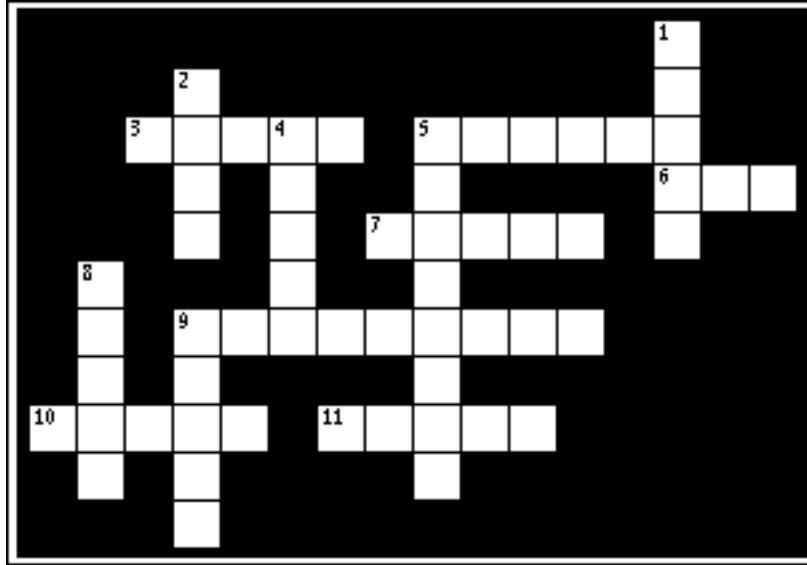

- 3 ACROSS "And it came to pass in the four hundred and eightieth year after the children of Israel had come out of the land of Egypt...that he began to build the _____ of the LORD." **1 KINGS 6:1**
- 7 ACROSS "No hammer or chisel or any iron tool was _____ in the temple while it was being built." **1 KINGS 6:7**
- 1 DOWN "He built the temple and finished it, and he paneled the temple with beam and boards of _____." **1 KINGS 6:9**
- 8 DOWN "And I will _____ among the children of Israel, and will not forsake My people Israel." **1 KINGS 6:13**
- 9 ACROSS "Then he built the twenty-cubit room at the rear of the temple, from floor to ceiling, with cedar boards; he built it inside as the inner _____, as the Most Holy Place." **1 KINGS 6:16**
- 6 ACROSS "And he prepared the inner sanctuary inside the temple, to set the _____ of the covenant of the LORD there." **1 KINGS 6:19**
- 2 DOWN "The whole temple he overlaid with _____, until he had finished all the temple." **1 KINGS 6:22**
- 5 DOWN "Inside the inner sanctuary he made two _____ of olive wood." **1 KINGS 6:23**
- 5 ACROSS "Then he _____ all the walls of the temple all around, both the inner and outer sanctuaries, with carved figures of cherubim, palm trees, and open flowers." **1 KINGS 6:29**
- 10 ACROSS "And the _____ of the temple he overlaid with gold, both the inner and outer sanctuaries." **KINGS 6:30**
- 11 ACROSS "For the entrance of the inner sanctuary he made doors of _____ wood." **1 KINGS 6:31**
- 9 DOWN "And he built the inner court with three rows of hewn _____ and a row of cedar beams." **1 KINGS 6:36**
- 4 DOWN "And Solomon was _____ years in building the temple." **1 KINGS 6:38**

Bible Story 92

THE DEDICATION OF THE TEMPLE

1 KINGS 8:1-66

92. THE DEDICATION OF THE TEMPLE

(1 KINGS 8:1-66)

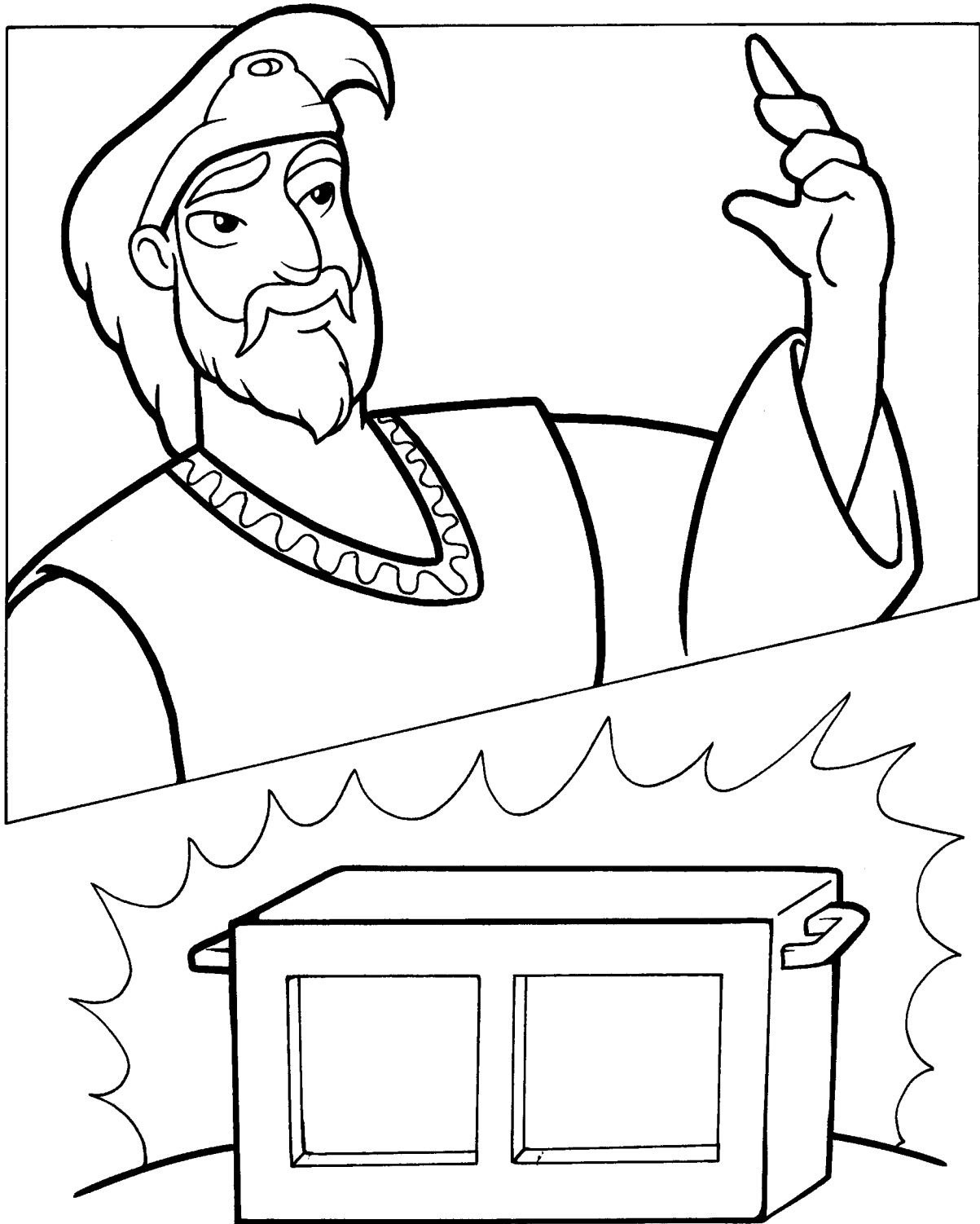

"Then Solomon assembled the elders of Israel, and all the heads of the tribes, the chief of the fathers of the children of Israel, unto king Solomon in Jerusalem, that they might bring up the ark of the covenant of the LORD out of the city of David, which *is* Zion."

1 KINGS 8:1

92. THE DEDICATION OF THE TEMPLE

(1 KINGS 8:1-66)

MEMORY VERSE:

"There has not failed one word of all His good promise, which He promised through His servant Moses." 1 KINGS 8:56

CIRCLE THE CORRECT WORD:

1. "Now Solomon assembled the elders of Israel and all the heads of the tribes, the chief fathers of the children of Israel, to King Solomon in Jerusalem, that they might bring up the (**ARK, ART**) of the covenant of the LORD from the City of David, which is Zion." 1 KINGS 8:1

UNDERLINE THE CORRECT ANSWER:

2. "And they brought up..." 1 KINGS 8:4
- a. the ark of the LORD
b. the tabernacle of meeting
c. all the holy furnishings that were in the tabernacle
d. all of the above

TRUE OR FALSE:

3. "The priests and the Levites brought them up." 1 KINGS 8:4
TRUE OR FALSE
4. "Also King Solomon, and all the congregation of Israel who were assembled to him, were with him before the ark, sacrificing sheep and oxen that could not be counted or numbered for multitude." 1 KINGS 8:5
TRUE OR FALSE

CIRCLE THE CORRECT WORDS:

5. "Then the priests brought in the ark of the covenant of the LORD to its place, into the inner sanctuary of the temple to the Most Holy Place, under the wings of the (**CHERUBIM, BIRDS**)." 1 KINGS 8:6
6. "There was nothing in the ark except the two (**PEBBLES, TABLETS**) of stone which Moses put there at Horeb, when the LORD made a covenant with the children of Israel, when he came out of the land of Egypt." 1 KINGS 8:9
7. "And it came to pass, when the priests came out of the holy place, that the (**CLOUD, FIRE**) filled the house of the LORD." 1 KINGS 8:10
8. "And the king turned around and (**SAW, BLESSED**) the whole congregation of Israel, while all the congregation of Israel was standing." 1 KINGS 8:14

TRUE OR FALSE:

9. "Then the king and all Israel with him offered sacrifices before the LORD." 1 KINGS 8:62
TRUE OR FALSE

CIRCLE THE CORRECT WORDS:

10. "At that time Solomon held a (**FEAST, FAST**), and all Israel with him, a great congregation from the entrance of Hamath to the Brook of Egypt, before the LORD our God, seven days and seven more days- fourteen days." 1 KINGS 8:65
11. "On the eighth day he sent the people away; and they blessed the king, and went to their tents joyful and glad of heart for all the (**GOODNESS, WORK**) that the LORD had done for His servant David, and for Israel His people." 1 KINGS 8:66

92. THE DEDICATION OF THE TEMPLE

(1 KINGS 8:1-66)

C I N M C M L K J Y C H W E L
H X G S U O U K M N V Q U B T
E G Z Z R L K P A J T O D K S
R Y J D M B S E T I V E L S A
U P S E C I F I R C A S S U E
B Y P F D P O Z H C L O U D F
I B N P L A I Y A T W A J H W
M D U G S C T D E S S E L B J
W E C A L P Y L O H T S O M A
B R O K V S T E L B A T H R U
M C S T S E I R P P H W K P O
W G F B R W E Y H L P V Q E E
F U R N I S H I N G S M O V P
U R L U C J J O Z J J F E A T
F G L R N O M O L O S S W R C

ARK
BLESSED
CHERUBIM
CLOUD
FEAST

FURNISHINGS
LEVITES
LORD
MOST HOLY PLACE

PRIESTS
SACRIFICES
SOLOMON
TABLETS

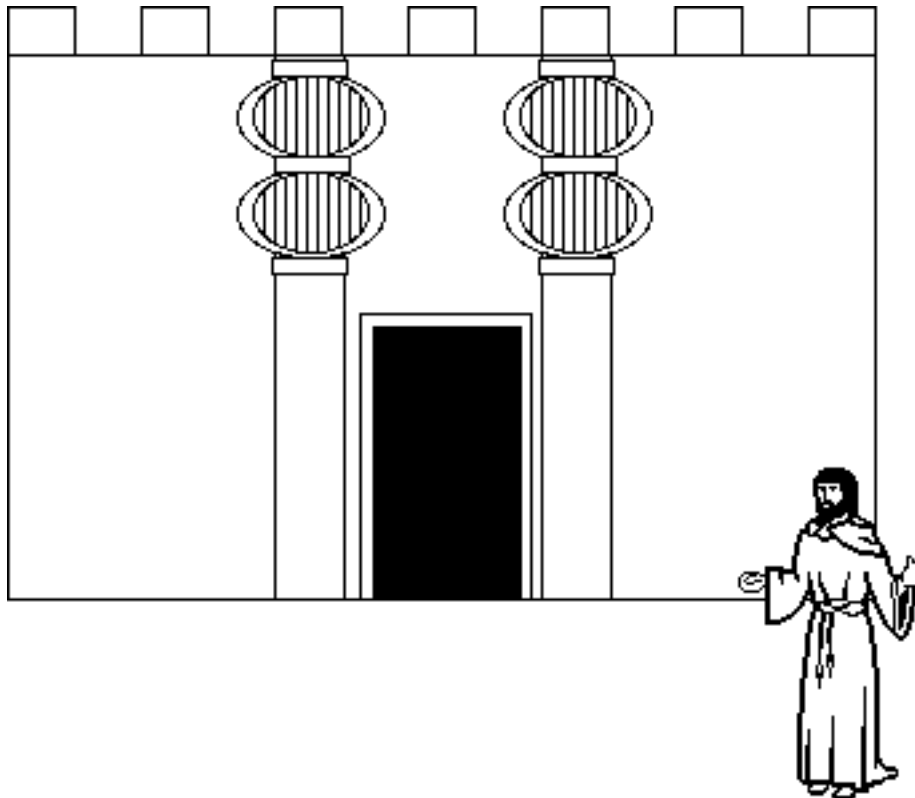

92. THE DEDICATION OF THE TEMPLE

(1 KINGS 8:1-66)

MEMORY VERSE:

"There has not failed one word of all His good promise, which He promised through His servant Moses." 1 KINGS 8:56

FILL IN THE BLANK:

1. "Now Solomon assembled the elders of Israel and all the heads of the tribes, the chief fathers of the children of Israel, to King Solomon in Jerusalem, that they might bring up the _____ of the covenant of the LORD from the City of David, which is Zion." **1 KINGS 8:1**

UNDERLINE THE CORRECT ANSWER:

2. "And they brought up..." **1 KINGS 8:4**
- | | |
|------------------------------|---|
| a. the ark of the LORD | c. all the holy furnishings that were in the tabernacle |
| b. the tabernacle of meeting | d. all of the above |

TRUE OR FALSE:

3. "The priests and the Levites brought them up." **1 KINGS 8:4**
TRUE OR FALSE
4. "Also King Solomon, and all the congregation of Israel who were assembled to him, were with him before the ark, sacrificing sheep and oxen that could not be counted or numbered for multitude." **1 KINGS 8:5**
TRUE OR FALSE

FILL IN THE BLANKS:

5. "Then the priests brought in the ark of the covenant of the LORD to its place, into the inner sanctuary of the temple to the Most Holy Place, under the wings of the _____." **1 KINGS 8:6**
6. "There was nothing in the ark except the two _____ of stone which Moses put there at Horeb, when the LORD made a covenant with the children of Israel, when they came out of the land of Egypt." **1 KINGS 8:9**
7. "And it came to pass, when the priests came out of the holy place, that the _____ filled the house of the LORD." **1 KINGS 8:10**
8. "And the king turned around and _____ the whole congregation of Israel, while all the congregation of Israel was standing." **1 KINGS 8:14**

TRUE OR FALSE:

9. "Then the king and all Israel with him offered sacrifices before the LORD." **1 KINGS 8:62**
TRUE OR FALSE

FILL IN THE BLANKS:

10. "At that time Solomon held a _____, and all Israel with him, a great congregation from the entrance of Hamath to the Brook of Egypt, before the LORD our God, seven days and seven more days- fourteen days." **1 KINGS 8:65**
11. "On the eighth day he sent the people away; and they blessed the king, and went to their tents joyful and glad of heart for all the _____ that the LORD had done for His servant David, and for Israel His people." **1 KINGS 8:66**

92. THE DEDICATION OF THE TEMPLE

(1 KINGS 8:1-66)

C S S F N C Z Y Z C P X O U P P E U P L
 Z L B A S P V Z A V R V K K E Q Z K E I
 R B B B H R U U R U E T P S U L U V L V
 D M Z R U F D G K I M O Z Y V R I Y O E
 Y I F X S M W M I B U R E H C T U H P M
 Q O W P Y E E F C P H F S M E C I F D N
 Q X X R J E E Y L N U J T S F G X Q Q B
 H K Y I N T C I W R Y A T F I O Q X J A
 R E L E D L B A N S B Q V L U W S H J S
 O Y N S Y M D I L L Y L G K H A B M C P
 I T D T I E S F E P M P W I C J T G X W
 H E C S B H V T C C Y V D R I V S Q V J
 H S V E I Z S D A N B L I Q P H A W D H
 Q Z O N L I N B E P P F O S K Y E G I N
 U Q G L O I P L Z S I G K H R G F M M F
 N S O W O D Y A S C S Y A S T M V W O C
 U V S G U M G L E C R E G O E S B D O L
 M L K F P Z O S D L Y Q L E N L O I P O
 N S L Z W R N N G C R D S B A U W M U U
 V R D A D P W E P X E O A Z I V Y C D D

ARK
 BLESSED
 CHERUBIM
 CLOUD
 FEAST

FURNISHINGS
 LEVITES
 LORD
 MOST HOLY PLACE

PRIESTS
 SACRIFICES
 SOLOMON
 TABLETS

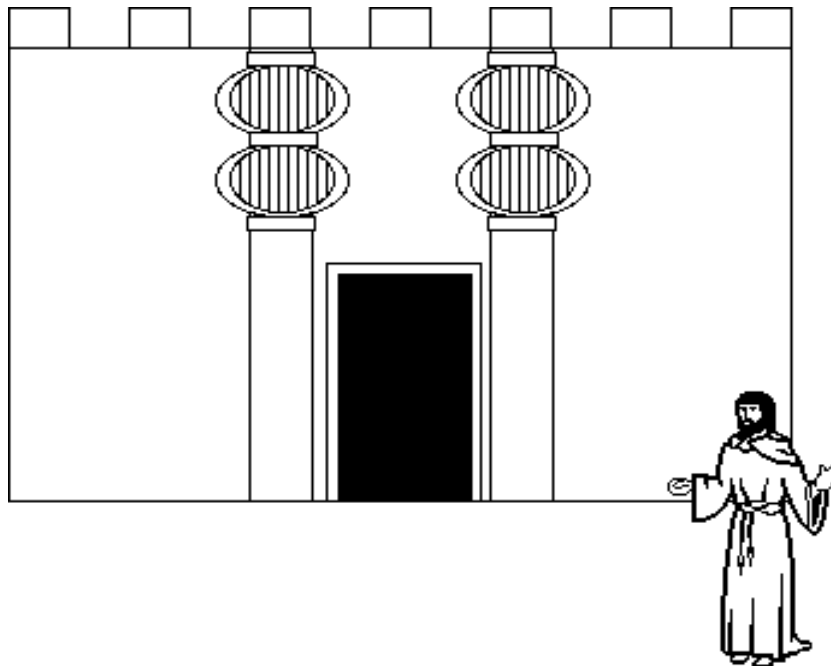

92. THE DEDICATION OF THE TEMPLE

(1 KINGS 8:1-66)

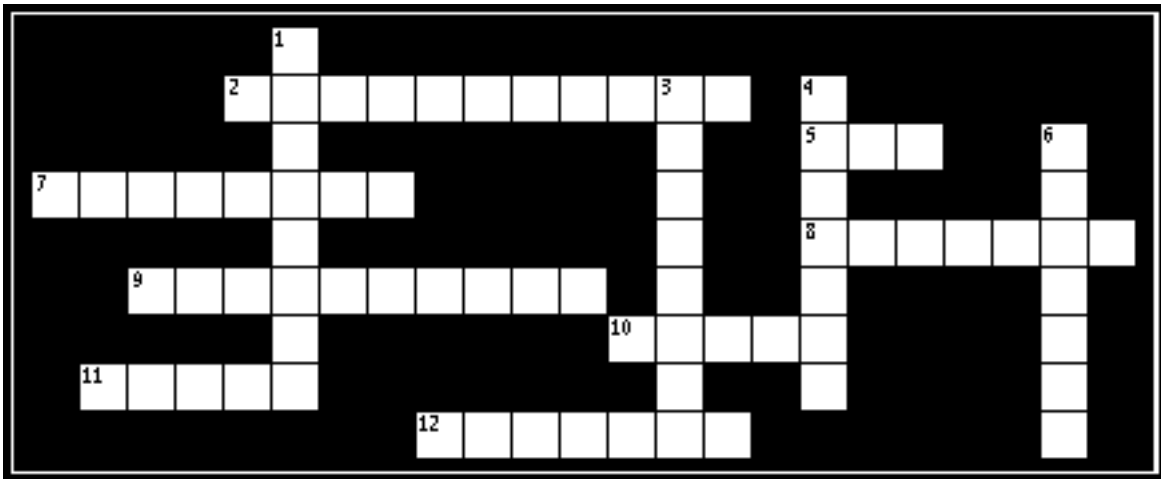

- 5 ACROSS "Now Solomon assembled the elders of Israel and all the heads of the tribes, the chief fathers of the children of Israel, to King Solomon in Jerusalem, that they might bring up the _____ of the covenant of the LORD from the City of David, which is Zion." **1 KINGS 8:1**
- 2 ACROSS "And they brought up the ark of the LORD, the tabernacle of meeting, and all the holy _____ that were in the tabernacle." **1 KINGS 8:4**
- 8 ACROSS "The priests and the _____ brought them up." **1 KINGS 8:4**
- 1 DOWN "Also King Solomon, and all the congregation of Israel who were assembled to him, were with him before the ark, sacrificing sheep and oxen that could not be counted or _____ for multitude." **1 KINGS 8:5**
- 7 ACROSS "Then the priests brought in the ark of the covenant of the LORD to its place, into the inner sanctuary of the temple to the Most Holy Place, under the wings of the _____." **1 KINGS 8:6**
- 4 DOWN "There was nothing in the ark except the two _____ of stone which Moses put there at Horeb." **1 KINGS 8:9**
- 11 ACROSS "And it came to pass, when the priests came out of the holy place, that the _____ filled the house of the LORD." **1 KINGS 8:10**
- 6 DOWN "And the king turned around and _____ the whole congregation of Israel, while all the congregation of Israel was standing." **1 KINGS 8:14**
- 12 ACROSS "There has not failed one word of all His good _____, which He promised through His servant Moses." **1 KINGS 8:56**
- 9 ACROSS "Then the king and all Israel with him offered _____ before the LORD." **1 KINGS 8:62**
- 10 ACROSS "At that time Solomon held a _____." **1 KINGS 8:65**
- 3 DOWN "On the eighth day he sent the people away; and they blessed the king, and went to their tents joyful and glad of heart for all the _____ that the LORD had done for His servant David, and for Israel His people." **1 KINGS 8:66**

Bible Story 93

THE QUEEN OF SHEBA

1 KINGS 10:1-13

93. THE QUEEN OF SHEBA

(1 KINGS 10:1-13)



"And she said to the king, It was a true report that I heard in mine own land of thy acts and of thy wisdom."
1 KINGS 10:6

93. THE QUEEN OF SHEBA

(1 KINGS 10:1-13)

MEMORY VERSE:

"Because the LORD has loved Israel forever, therefore He made you king, to do justice and righteousness." 1 KINGS 10:9

TRUE OR FALSE:

1. "Now when the queen of Sheba heard of the fame of Solomon concerning the name of the LORD, she came to test him with hard questions." 1 KINGS 10:1

TRUE OR FALSE

CIRCLE THE CORRECT WORDS:

2. "She came to Jerusalem with a very great retinue, with camels that bore (SPICES, MICE), very much (MOLD, GOLD), and precious (STICKS, STONES)." 1 KINGS 10:2

TRUE OR FALSE:

3. "So Solomon answered all her questions; there was nothing so difficult for the king that he could not explain it to her." 1 KINGS 10:3

TRUE OR FALSE

4. Then she said to the king: "It was not a true report which I heard in my own land about your words and your wisdom." 1 KINGS 10:6

TRUE OR FALSE

FILL IN THE BLANKS:

5. She said, "_____ are your men and _____ are these your servants, who stand continually before you and hear your wisdom!" 1 KINGS 10:8

TRUE OR FALSE:

6. "She gave the king one hundred and twenty talents of gold, spices in great abundance, and precious stones." 1 KINGS 10:10

TRUE OR FALSE

7. "Also, the ships of Hiram, which brought gold from Ophir, brought great quantities of almuq wood and precious stones from Ophir." 1 KINGS 10:11

TRUE OR FALSE

8. But King Solomon gave nothing to the queen of Sheba. 1 KINGS 10:13

TRUE OR FALSE

CIRCLE THE CORRECT WORD:

9. "So she turned and went to her own (COUNTRY, CHARIOT), she and her servants." 1 KINGS 10:13

93. THE QUEEN OF SHEBA

(1 KINGS 10:1-13)

Q U E S T I O N S G Q D N G K
V P U N U A H I Y X J I F I J
G Z N F V I Y X H W J V N I T
Y D O O W G U M L A C G Q E B
Q S J L F P G Q F D S E U G M
D T E K I Q M B Q O P M E W O
T V R I U L X V L D V N E K D
R G U Q H R U O L I D B N O S
O W S S I C M O X C I A O I I
P D A S P O G B H P M S F L W
E K L O N G V S E C I P S D V
R A E E K O E W M L O P H S Q
O G M Z R W Z Y G O O W E U O
O S S P E J U U Q P F J B J V
K A Y E N V U K W D U H A L Y

ALMUG WOOD

QUESTIONS

GOLD

REPORT

JERUSALEM

SPICES

KING SOLOMON

WISDOM

QUEEN OF SHEBA

93. THE QUEEN OF SHEBA

(1 KINGS 10:1-13)

MEMORY VERSE:

"Because the LORD has loved Israel forever, therefore He made you king, to do justice and righteousness." 1 KINGS 10:9

TRUE OR FALSE:

1. "Now when the queen of Sheba heard of the fame of Solomon concerning the name of the LORD, she came to test him with hard questions." 1 KINGS 10:1

TRUE OR FALSE

FILL IN THE BLANKS:

2. "She came to Jerusalem with a very great retinue, with camels that bore _____, very much _____, and precious _____." 1 KINGS 10:2

TRUE OR FALSE:

3. "So Solomon answered all her questions; there was nothing so difficult for the king that he could not explain it to her." 1 KINGS 10:3

TRUE OR FALSE

4. Then she said to the king: "It was not a true report which I heard in my own land about your words and your wisdom." 1 KINGS 10:6

TRUE OR FALSE

FILL IN THE BLANKS:

5. She said, "_____ are your men and _____ are these your servants, who stand continually before you and hear your wisdom!" 1 KINGS 10:8

6. "She gave the king one hundred and twenty _____ of gold, spices in great abundance, and precious stones." 1 KINGS 10:10

7. "Also, the ships of Hiram, which brought gold from Ophir, brought great quantities of _____ and precious stones from Ophir." 1 KINGS 10:11

TRUE OR FALSE:

8. But King Solomon gave nothing to the queen of Sheba. 1 KINGS 10:13

TRUE OR FALSE

FILL IN THE BLANK:

9. "So she turned and went to her own _____, she and her servants." 1 KINGS 10:13

93. THE QUEEN OF SHEBA

(1 KINGS 10:1-13)

R Z J N O M O L O S G N I K A R G F Z F
G Y X G B D M W I S U W K S U G V E M D
U U B V U F O C L P N G S Y Y N E Z J Q
J V H T W R Y O U Y Z O I T E F A H A D
A M Z Y N D U H W J M G I G D Q B F P I
H Y Y M Y K K H H G F O S T K N Y M N D
P A Q E D S S O B V U V D R S I Z C E B
R J P L H F S B Q T N M X S J E R G P V
M R V A I X V B U C M B L R I G U J X W
A O M S R Y Y N E V H I W A Y W Q Q U Z
U M V U E D Z Z E S I F J K Z J V O U L
L Q O R P C N G N H E L N U Y L E X H O
M D T E O P O F O D V L K P R D Y F Y J
I T J J R L W S F L M Y G S B K B O J L
N O Z E T R K C S H N E A Q I G P X A N
L U O R I Z I P H Z I Q Z V D C B V L A
G C V B A P Z S E C I P S Y A B N E C Y
X H L G O L D Z B E M T I E M B Y H Q O
Y E C W L D A A A S J X N Z D V Q C Y P
V Q E I N H A K P Q C B T P I K Q K V X

ALMUG WOOD

QUESTIONS

GOLD

REPORT

JERUSALEM

SPICES

KING SOLOMON

WISDOM

QUEEN OF SHEBA

93. THE QUEEN OF SHEBA

(1 KINGS 10:1-13)

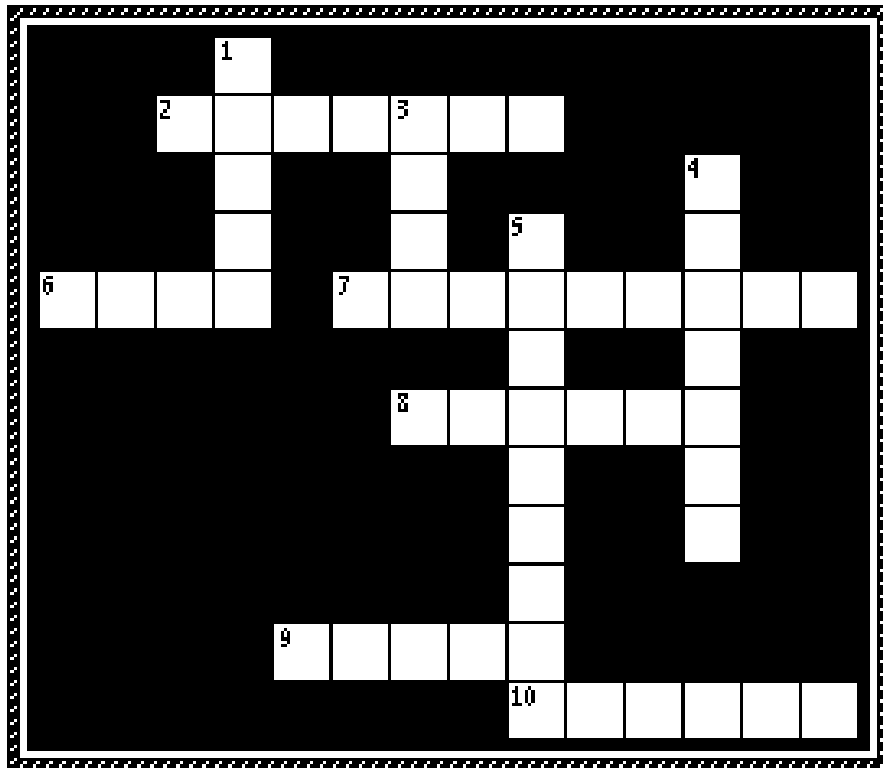

- 5 DOWN "Now when the queen of Sheba heard of the fame of Solomon concerning the name of the LORD, she came to test him with hard ____." **1 KINGS 10:1**
- 7 ACROSS "She came to ____ with a very great retinue, with camels that bore spices, very much gold, and precious stones." **1 KINGS 10:2**
- 4 DOWN "So ____ answered all her questions; there was nothing so difficult for the king that he could not explain it to her." **1 KINGS 10:3**
- 3 DOWN "Then she said to the king: 'It was a ____ report which I heard in my own land about your words and your wisdom.'" **1 KINGS 10:6**
- 8 ACROSS She said, "Happy are your men and happy are these your servants, who stand continually before you and hear your ____!" **1 KINGS 10:8**
- 1 DOWN "Because the LORD has ____ Israel forever, therefore He made you king, to do justice and righteousness." **1 KINGS 10:9**
- 10 ACROSS "She gave the king one hundred and twenty talents of gold, ____ in great abundance, and precious stones." **1 KINGS 10:10**
- 6 ACROSS "Also, the ships of Hiram, which brought ____ from Ophir, brought great quantities of almag wood and precious stones from Ophir." **1 KINGS 10:11**
- 9 ACROSS "And King Solomon gave the ____ of Sheba all she desired." **1 KINGS 10:13**
- 2 ACROSS "So she turned and went to her own ____, she and her servants." **1 KINGS 10:13**

Bible Story 94

**SOLOMON TURNS
FROM THE LORD**

1 KINGS 11:1-13, 41-43

94. SOLOMON TURNS FROM THE LORD

(1 KINGS 11:1-13, 41-43)



"Wherefore the LORD said unto Solomon, Forasmuch as this is done of thee, and thou hast not kept my covenant and my statutes, which I have commanded thee, I will surely rend the kingdom from thee, and will give it to thy servant."

1 KINGS 11:11

94. SOLOMON TURNS FROM THE LORD

(1 KINGS 11:1-13, 41-43)

MEMORY VERSE:

"So the LORD became angry with Solomon, because his heart had turned from the LORD God of Israel." 1 KINGS 11:9

CIRCLE THE CORRECT WORDS:

1. "For it was so, when Solomon was old, that his wives turned his (**HEAD, HEART**) after other gods; and his (**HEAD, HEART**) was not loyal to the LORD his God, as was the (**HEAD, HEART**) of his father David." 1 KINGS 11:4

TRUE OR FALSE:

2. "For Solomon went after Ashtoreth the goddess of the Sidonians, and after Milcom the abomination of the Ammonites." 1 KINGS 11:5
TRUE OR FALSE
3. "Then Solomon built a high place for Chemosh the abomination of Moab, on the hill that east of Jerusalem, and for Molech the abomination of the people of Ammon." 1 KINGS 11:7
TRUE OR FALSE

FILL IN THE BLANKS:

4. "And he did likewise for _____ his _____, who burned incense and sacrificed to their gods." 1 KINGS 11:8

CIRCLE THE CORRECT WORDS:

5. "So the LORD became (**HAPPY, ANGRY**) with Solomon, because his heart had turned from the LORD God of Israel, who had appeared to him twice." 1 KINGS 11:9
6. The LORD "had commanded him concerning this thing, that he (**SHOULD, SHOULD NOT**) go after other gods; but he did not keep what the LORD had commanded." 1 KINGS 11:10

TRUE OR FALSE:

7. "Therefore the LORD said to Solomon, 'Because you have done this, and have not kept My covenant and My statutes, which I have commanded you, I will surely tear the kingdom away from you and give it to your servant.' " 1 KINGS 11:11
TRUE OR FALSE

CIRCLE THE CORRECT WORD:

8. The LORD said, "However I will not tear away the whole kingdom, but I will give (**ONE TRIBE, SIX TRIBES**) to your son for the sake of My servant David, and for the sake of Jerusalem which I have chosen." 1 KINGS 11:13

94. SOLOMON TURNS FROM THE LORD

(1 KINGS 11:1-13, 41-43)

N E V S M R L O D Y S F E G Z
W Z U C W E L O R D G O D O U
Y C I I H P P K K L O I N W U
Z L V N Y M E L A S U R E J I
U E P P D C O V E N A N T J X
S W E C S E V P A F E U A V Y
G C B N Y T D Z G L Z H I R Q
H A I C M V A N S K P I G H B
Y Z R X B T G T A I E N P Y V
I S T P U T Y S U M A P Q G B
F D E R P O Q T A T M K F M W
B G N R R J D V U Q E O R M Y
L E O S O L O M O N U S C J U
D P N E Y Q O G K S V R C V R
A C T R A E H W S R A E T E Y

ANGRY
COMMANDED
COVENANT
HEART

JERUSALEM
LORD GOD
ONE TRIBE
SOLOMON

STATUTES
TEAR
TURNED
WIVES

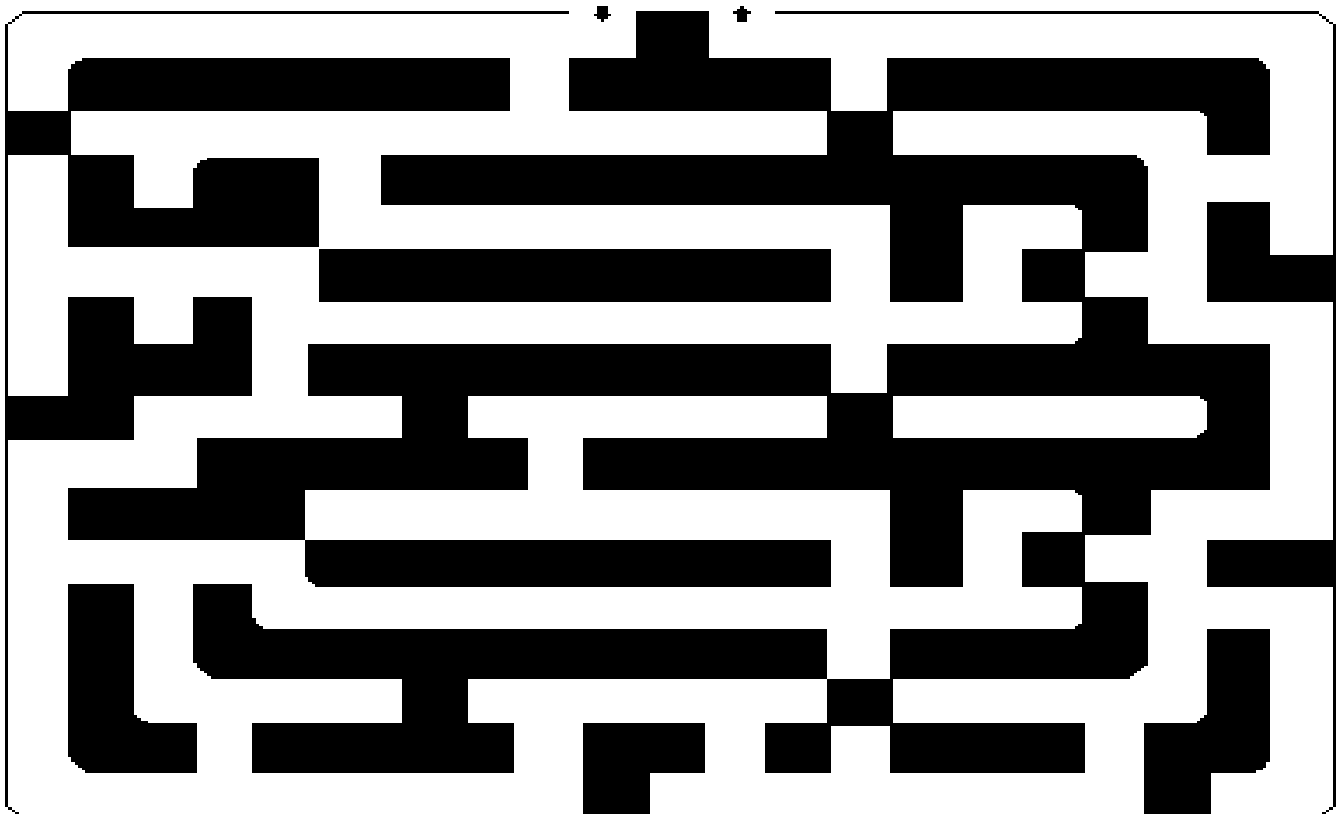

94. SOLOMON TURNS FROM THE LORD

(1 KINGS 11:1-13, 41-43)

MEMORY VERSE:

"So the LORD became angry with Solomon, because his heart had turned from the LORD God of Israel." 1 KINGS 11:9

FILL IN THE BLANKS:

1. "For it was so, when Solomon was old, that his wives turned his _____ after other gods; and his _____ was not loyal to the LORD his God, as was the _____ of his father David." 1 KINGS 11:4

TRUE OR FALSE:

2. "For Solomon went after Ashtoreth the goddess of the Sidonians, and after Milcom the abomination of the Ammonites." 1 KINGS 11:5
TRUE OR FALSE
3. "Then Solomon built a high place for Chemosh the abomination of Moab, on the hill that east of Jerusalem, and for Molech the abomination of the people of Ammon." 1 KINGS 11:7
TRUE OR FALSE

FILL IN THE BLANKS:

4. "And he did likewise for _____ his _____, who burned incense and sacrificed to their gods." 1 KINGS 11:8
5. "So the LORD became _____ with Solomon, because his heart had turned from the LORD God of Israel, who had appeared to him twice." 1 KINGS 11:9
6. The LORD "had commanded him concerning this thing, that he _____ go after other gods; but he did not keep what the LORD had commanded." 1 KINGS 11:10

TRUE OR FALSE:

7. "Therefore the LORD said to Solomon, 'Because you have done this, and have not kept My covenant and My statutes, which I have commanded you, I will surely tear the kingdom away from you and give it to your servant.' " 1 KINGS 11:11
TRUE OR FALSE

FILL IN THE BLANKS:

8. The LORD said, "However I will not tear away the whole kingdom, but I will give _____ to your son for the sake of My servant David, and for the sake of Jerusalem which I have chosen." 1 KINGS 11:13

94. SOLOMON TURNS FROM THE LORD

(1 KINGS 11:1-13, 41-43)

D V H T N A N E V O C P S C K Y E F A Z
 I I P V T D E N H S S P Q W D T D Q B H
 Y E R M O M O F M Z E Y U E S G K N Y F
 N A M Y U V R G Y N Z V N G I R J I Z M
 A A A A C O B R D O Y R I G S R Y G R C
 P Q U S N T W D U R U R Z W X K Z J Q G
 N X L E B I R T K T O D G V W U Y L V J
 A P M T E J I K J W G L E N J P R D E O
 W F I U Q T B S E K F J F D A S B K Y D
 Q M F T E Z U F R I X V N B N Q I G B F
 L G L A J O W L U Z C T M I F A D C P O
 Q E R T X V N Y S A X C F F M V M B B M
 K W G S B L Y D A A Z V I L G Y A M N V
 N O M O L O S C L W A S E L A E M B O E
 E K X J H C D P E C W H V Y Z Z D V Y C
 K R Y R Z E H L M H I D M E I P I K Q H
 H G V O Y G I R S H L L N Q N A R G Q C
 Y U Z M Q V I Z S O U H I T T R A E H K
 X J Y Q P T A P V F H Z M M T U G V F Z
 J A U D V Y L D Y B B E J B S Y K E E M

ANGRY
 COMMANDED
 COVENANT
 HEART

JERUSALEM
 LORD GOD
 ONE TRIBE
 SOLOMON

STATUTES
 TEAR
 TURNED
 WIVES

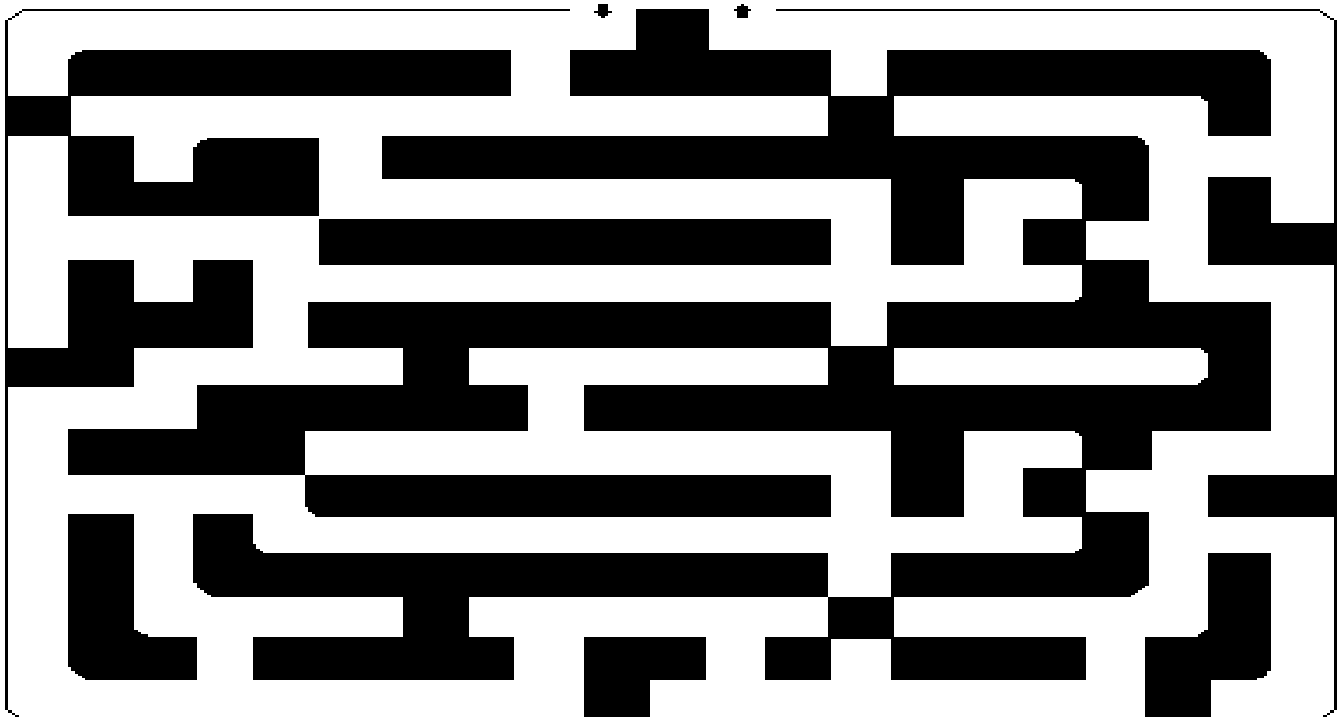

94. SOLOMON TURNS FROM THE LORD

(1 KINGS 11:1-13, 41-43)

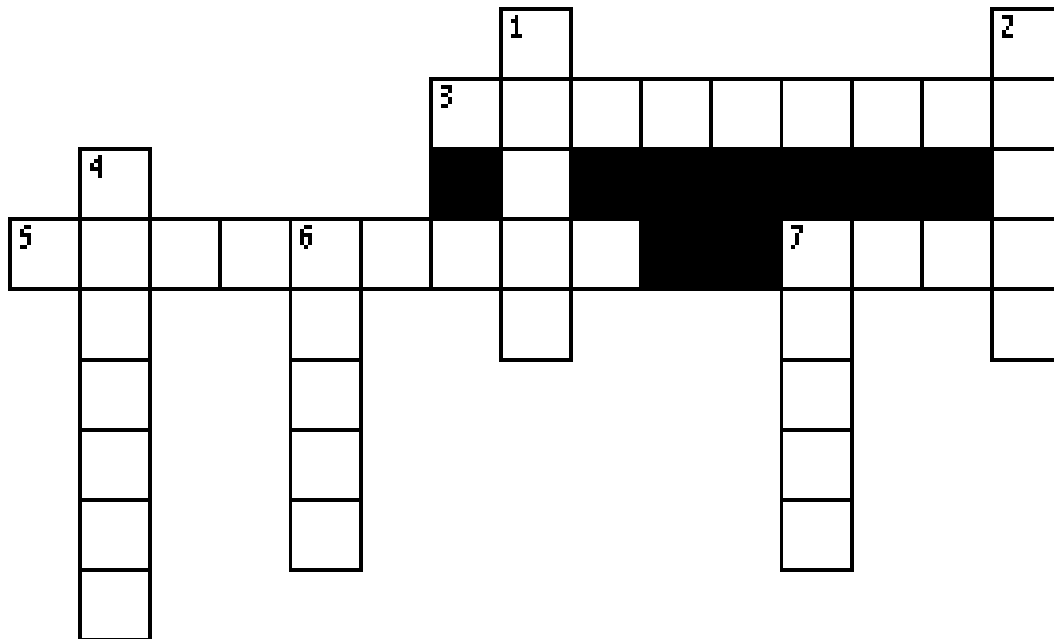

- 2 DOWN "For it was so, when Solomon was old, that his wives turned his _____ after other gods; and his heart was not loyal to the LORD his God, as was the heart of his father David." **1 KINGS 11:4**
- 4 DOWN "For _____ went after Ashtoreth the goddess of the Sidonians, and after Milcom the abomination of the Ammonites." **1 KINGS 11:5**
- 3 ACROSS "Then Solomon built a _____ _____ for Chemosh the abomination of Moab, on the hill that east of Jerusalem, and for Molech the abomination of the people of Ammon." **1 KINGS 11:7**
- 1 DOWN "And he did likewise for all his foreign _____, who burned incense and sacrificed to their gods." **1 KINGS 11:8**
- 6 DOWN "So the LORD became _____ with Solomon, because his heart had turned from the LORD God of Israel, who had appeared to him twice." **1 KINGS 11:9**
- 5 ACROSS The LORD "had _____ him concerning this thing, that he should not go after other gods; but he did not keep what the LORD had commanded." **1 KINGS 11:10**
- 7 ACROSS "Therefore the LORD said to Solomon, 'Because you have done this, and have not kept My covenant and My statutes, which I have commanded you, I will surely _____ the kingdom away from you and give it to your servant.' " **1 KINGS 11:11**
- 7 DOWN The LORD said, "However I will not tear away the whole kingdom, but I will give one _____ to your son for the sake of My servant David, and for the sake of Jerusalem which I have chosen." **1 KINGS 11:13**

Bible Story 95

THE KINGDOM IS DIVIDED

1 KINGS 11:26-40; 12:1-24

95. THE KINGDOM IS DIVIDED

(1 KINGS 11:26-40; 12:1-24)

"... thus saith the Lord, the God of Israel,
Behold, I will tear the kingdom out of the hand of
Solomon, and will give ten tribes to thee."

1 Kings 11:31



95. THE KINGDOM IS DIVIDED

(1 KINGS 11:26-40; 12:1-24)

MEMORY VERSE:

"For the turn of affairs was from the LORD, that He might fulfill His word." 1 KINGS 12:15

TRUE OR FALSE:

1. "Jeroboam was a mighty man of valor; and Solomon, seeing that the young man was industrious, made him the officer over all the labor force of the house of Joseph." 1 KINGS 11:28

TRUE OR FALSE

CIRCLE THE CORRECT WORDS:

2. "Now it happened at that time, when Jeroboam went out of Jerusalem, that the (KING, PROPHET) Ahijah the Shilonite met him on the way; and he had clothed himself with a new garment, and the two were alone in the field." 1 KINGS 11:29
3. "Then Ahijah took hold of the new (GARMENT, CARPET) that was on him, and tore it into twelve pieces." 1 KINGS 11:30
4. "And he said to Jeroboam, 'Take for yourself (TWO, TEN) pieces, for thus says the LORD, the God of Israel: 'Behold, I will tear the kingdom out of the hand of Solomon and will give (TWO, TEN) tribes to you.' " 1 KINGS 11:31

FILL IN THE BLANKS:

5. The LORD said, "I will take the kingdom out of his son's hand and give it to you- ten tribes. And to his son I will give one tribe, that My servant David may always have a _____ before Me in Jerusalem, the city which I have chosen for Myself, to put My name there." 1 KINGS 11:36
6. "Then it shall be, if you heed all that I command you, walk in _____ ways, and do what is right in _____ sight, to keep _____ statutes and _____ commandments, as _____ servant David did, then I will be with you and build for you an enduring house, as I built for David, and will give Israel to you." 1 KINGS 11:38

TRUE OR FALSE:

7. "Now Rehoboam went to Shechem, for all Israel had gone to Shechem to make him king." 1 KINGS 12:1

TRUE OR FALSE

CIRCLE THE CORRECT WORDS:

8. "Then Jeroboam and the whole congregation of Israel came and spoke to Rehoboam, saying, 'Your father made our (YOKE, JOKE) heavy; now therefore, lighten the burdensome service of your father, and his heavy (YOKE, JOKE) which he put on us, and we will serve you.' " 1 KINGS 12:3-4

TRUE OR FALSE:

9. "King Rehoboam consulted the elders who stood before his father Solomon while he still lived." 1 KINGS 12:6

TRUE OR FALSE

10. And King Rehoboam accepted the counsel which the elders gave him. 1 KINGS 12:8

TRUE OR FALSE

CIRCLE THE CORRECT WORD:

11. So Jeroboam and all the people came to Rehoboam "and he spoke to them according to the counsel of the young men, saying, 'My father made your yoke heavy, but I will add to your yoke; my father chastised you with whips, but I will chastise you with (SCOURGES, COURAGE)! " 1 KINGS 12:14

95. THE KINGDOM IS DIVIDED

(1 KINGS 11:26-40; 12:1-24)

D R E H O B O A M K H M L C S
 O E S R E D L E I D S M P K H
 F D T Y L J T N Q J M D U W Y
 F I E C W Y G D I E K N R Q K
 I N V E E D U P T R Y K Z O E
 C L L B O J N U N O O B N R L
 E F E M S S E T E B H A U S R
 R N W R N B P R M O I E C G Q
 S J T A S D D Q R A Q O Q E K
 R M E G I N T L A M U R V N K
 R P U T M D V Y G R K Q I D V
 V Y A I Y O U N G M E N Z I B
 Y K N O M Q P E T E H P O R P
 B W L Y Z W S I G W L L S L J
 D Y B M K J T G J Y Z N L W P

ELDERS
 GARMENT
 JEROBOAM
 KINGDOM

LORD
 OFFICER
 PROPHET
 REHOBOAM

REJECTED
 SCOURGES
 TWELVE
 YOUNG MEN

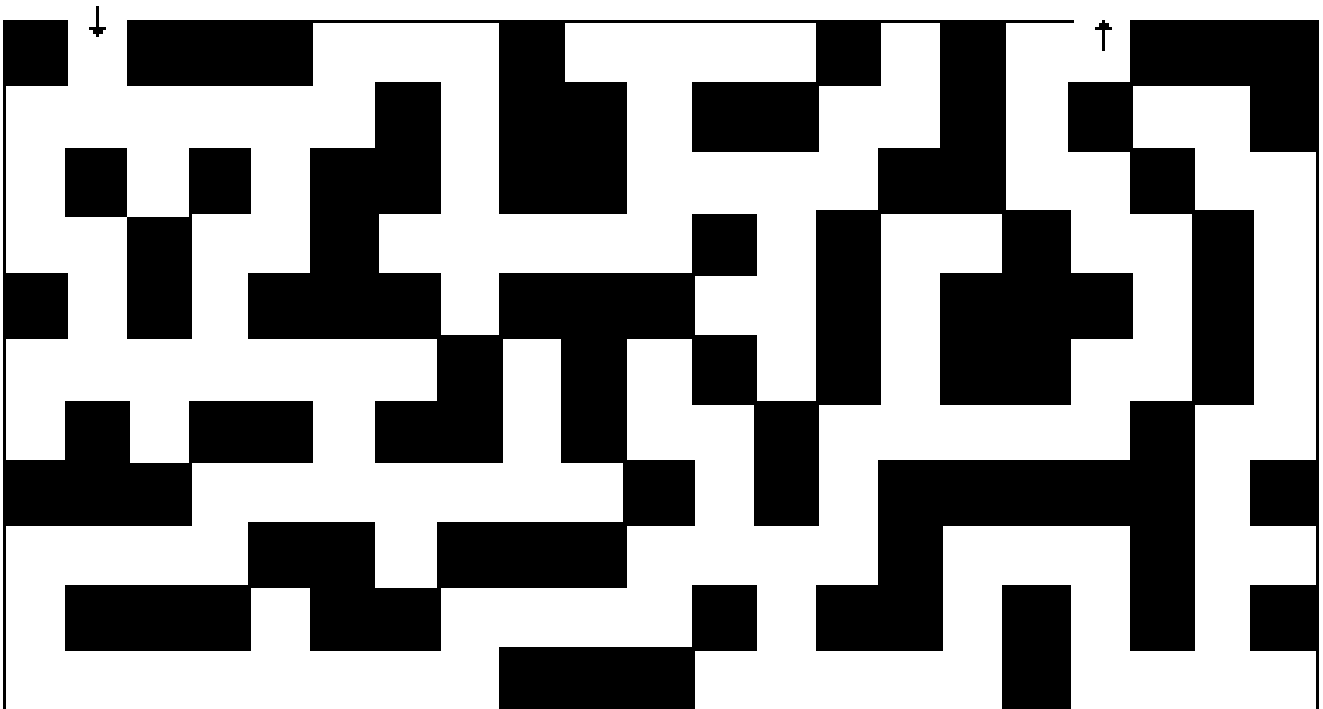

95. THE KINGDOM IS DIVIDED

(1 KINGS 11:26-40; 12:1-24)

MEMORY VERSE:

"For the turn of affairs was from the LORD, that He might fulfill His word." 1 KINGS 12:15

TRUE OR FALSE:

1. "Jeroboam was a mighty man of valor; and Solomon, seeing that the young man was industrious, made him the officer over all the labor force of the house of Joseph." 1 KINGS 11:28

TRUE OR FALSE

FILL IN THE BLANKS:

2. "Now it happened at that time, when Jeroboam went out of Jerusalem, that the _____ Ahijah the Shilonite met him on the way; and he had clothed himself with a new garment, and the two were alone in the field." 1 KINGS 11:29
3. "Then Ahijah took hold of the new _____ that was on him, and tore it into twelve pieces." 1 KINGS 11:30
4. "And he said to Jeroboam, 'Take for yourself _____ pieces, for thus says the LORD, the God of Israel: "Behold, I will tear the kingdom out of the hand of Solomon and will give _____ tribes to you." ' " 1 KINGS 11:31
5. The LORD said, "I will take the kingdom out of his son's hand and give it to you- ten tribes. And to his son I will give one tribe, that My servant David may always have a _____ before Me in Jerusalem, the city which I have chosen for Myself, to put My name there." 1 KINGS 11:36
6. "Then it shall be, if you heed all that I command you, walk in _____ ways, and do what is right in _____ sight, to keep _____ statutes and _____ commandments, as _____ servant David did, then I will be with you and build for you an enduring house, as I built for David, and will give Israel to you." 1 KINGS 11:38

TRUE OR FALSE:

7. "Now Rehoboam went to Shechem, for all Israel had gone to Shechem to make him king." 1 KINGS 12:1

TRUE OR FALSE

FILL IN THE BLANKS:

8. "Then Jeroboam and the whole congregation of Israel came and spoke to Rehoboam, saying, 'Your father made our _____ heavy; now therefore, lighten the burdensome service of your father, and his heavy _____ which he put on us, and we will serve you.' " 1 KINGS 12:3-4

TRUE OR FALSE:

9. "King Rehoboam consulted the elders who stood before his father Solomon while he still lived." 1 KINGS 12:6

TRUE OR FALSE

10. And King Rehoboam accepted the counsel which the elders gave him. 1 KINGS 12:8

TRUE OR FALSE

FILL IN THE BLANKS:

11. So Jeroboam and all the people came to Rehoboam "and he spoke to them according to the counsel of the young men, saying, 'My father made your yoke heavy, but I will add to your yoke; my father chastised you with whips, but I will chastise you with _____!' " 1 KINGS 12:14

95. THE KINGDOM IS DIVIDED

(1 KINGS 11:26-40; 12:1-24)

M O D G N I K R H D I G K O O N G T M I
 C M M N D G N I H L P H E T T V K P H R
 B S B Q D B E Y O O M G O C H G M M V O
 B O A Q D L B R B F W N J U S R P S Y N
 Y A K H V L D S R N L W S R K K E D X T
 U L I V V N P S B T G B E V W Z I Q R V
 W K Y Z D W U Y E M E D Z N W L P E L B
 D N T U K Z U D A B L H N V S S H H M K
 O M B D P S R O U E I W P M L O L E E C
 K G Z F S V B Y S Q S R W O B I E N J E
 J G B H H O J E L G Z B T O R O P P L U
 Q T C G R M G B A R D V A E F P K T D Z
 L E S E P R Z R Y E R M I F V V S D Z B
 Z L J U U O M O D K O B I N R L E L P E
 P S L O P E F I L D J C O O Q T E Z E Q
 Q V C Q N N V J H F E H V X C V N W B A
 L S S T R I J C D R L C M E C T U T T L
 A P N J D G F V K H L O J M R L W T L B
 L Z P V B I E G K L A E G G H C S O I F
 L S M Q N C O W X D R Y D Q N M C S A H

ELDERS
 GARMENT
 JEROBOAM
 KINGDOM

LORD
 OFFICER
 PROPHET
 REHOBOAM

REJECTED
 SCOURGES
 TWELVE TRIBES
 YOUNG MEN

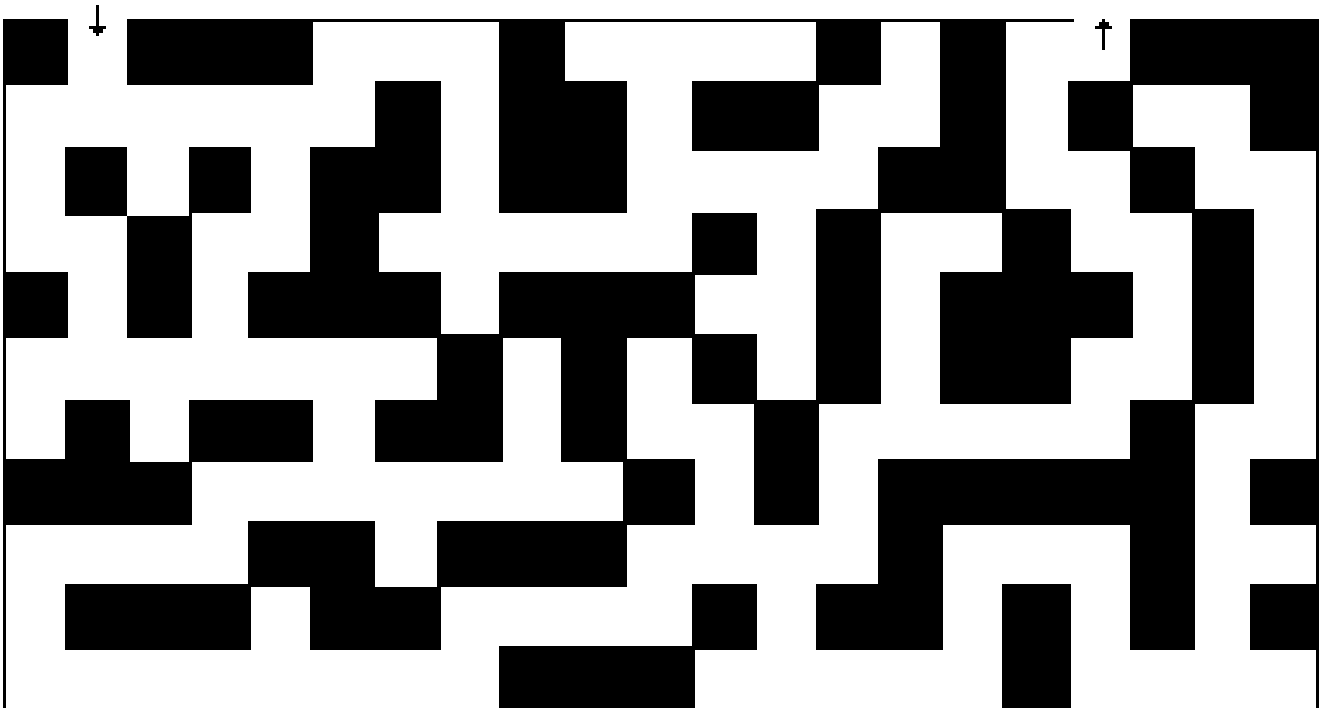

95. THE KINGDOM IS DIVIDED

(1 KINGS 11:26-40; 12:1-24)

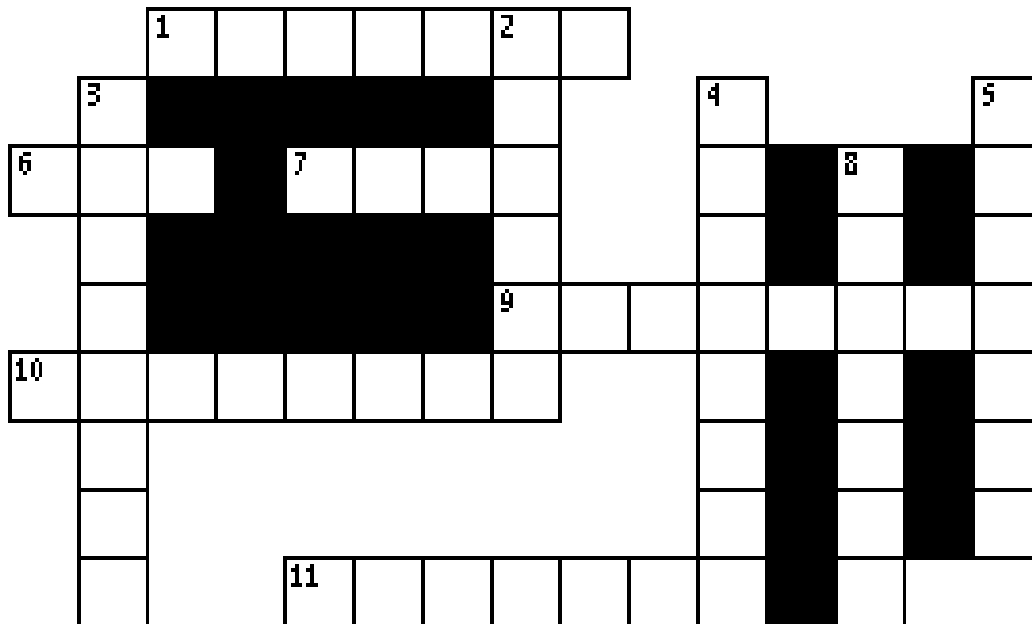

- 1 ACROSS "Jeroboam was a mighty man of valor; and Solomon , seeing that the young man was industrious, made him the _____ over all the labor force of the house of Joseph." **1 KINGS 11:28**
- 8 DOWN "Now it happened at that time, when Jeroboam went out of Jerusalem, that the _____ Ahijah the Shilonite met him on the way." **1 KINGS 11:29**
- 5 DOWN "Then Ahijah took hold of the new _____ that was on him, and tore it into twelve pieces." **1 KINGS 11:30**
- 6 ACROSS "And he said to Jeroboam, 'Take for yourself _____ pieces.'" **1 KINGS 11:31**
- 11 ACROSS The LORD said, "I will take the _____ out of his son's hand and give it to you- ten tribes." **1 KINGS 11:36**
- 9 ACROSS "Now _____ went to Shechem, for all Israel had gone to Shechem to make him king." **1 KINGS 12:1**
- 4 DOWN "Then _____ and the whole congregation of Israel came and spoke to Rehoboam." **1 KINGS 12:3-4**
- 2 DOWN "King Rehoboam consulted the _____ who stood before his father Solomon while he still lived." **1 KINGS 12:6**
- 3 DOWN "But he _____ the counsel which the elders gave him." **1 KINGS 12:8**
- 10 ACROSS So Jeroboam and all the people came to Rehoboam "and he spoke to them according to the counsel of the young men, saying, 'My father made your yoke heavy, but I will add to your yoke; my father chastised you with whips, but I will chastise you with _____!'" **1 KINGS 12:14**
- 7 ACROSS "For the turn of affairs was from the _____, that He might fulfill His word." **1 KINGS 12:15**

Bible Story 96

**JEROBOAM
MAKES TWO
GOLDEN CALVES**

1 KINGS 12:25-13:6

96. JEROBOAM MAKES TWO GOLDEN CALVES

(1 KINGS 12:25-13:6)



"Whereupon the king took counsel, and made two calves *of* gold, and said unto them, It is too much for you to go up to Jerusalem: behold thy gods, O Israel, which brought thee up out of the land of Egypt."

1 KINGS 12:28

96. JEROBOAM MAKES TWO GOLDEN CALVES

(1 KINGS 12:25-13:6)

MEMORY VERSE:

"Now this thing became a sin, for the people went to worship before the one as far as Dan." 1 KINGS 13:30

CIRCLE THE CORRECT WORDS:

1. "Jeroboam said in his heart, 'Now the kingdom may return to the house of David: if these people go up to offer sacrifices in the house of the LORD at (**JERUSALEM, BETHLEHEM**), then the heart of this people will turn back to their lord, Rehoboam king of Judah, and they will kill me and go back to Rehoboam king of Judah.' " **1 KINGS 12:26-27**
2. "Therefore the king took counsel and made two (**HALVES, CALVES**) of gold, and said to the people, 'It is too much for you to go up to Jerusalem. Here are your gods, O Israel, which brought you up from the land of Egypt!' " **1 KINGS 12:28**

FILL IN THE BLANKS:

3. "And he set one up in _____, and the other he put in _____." **1 KINGS 12:29**
4. "Now this thing became a _____, for the people went to worship before the one as far as Dan." **1 KINGS 12:30**

TRUE OR FALSE:

5. "He made shrines on the high places, and made priests from every class of people, who were not of the sons of Levi." **1 KINGS 12:31**

TRUE OR FALSE

6. "Behold, a man of God went from Judah to Bethel by the word of the LORD, and Jeroboam stood by the altar to burn incense." **1 KINGS 13:1**

TRUE OR FALSE

CIRCLE THE CORRECT WORDS:

7. "Then he cried out against the altar by the word of the LORD, and said, 'O altar, altar! Thus says the LORD: "Behold, a child, (**JOSEPH, JOSIAH**) by name, shall be born to the house of David; and on you he shall sacrifice the priests of the high places who burn incense on you, and men's bones shall be burned on you.' " " **1 KINGS 13:2**
8. "And he gave a sign the same day, saying, 'This is the sign which the LORD has spoken: Surely the (**ALTAR, TREES**) shall split apart, and ashes on it shall be poured out.' " **1 KINGS 13:3**
9. "So it came to pass when King Jeroboam heard the saying of the man of God, who cried out against the altar in Bethel, that he stretched out his (**FOOT, HAND**) from the altar, saying, 'Arrest him!' " **1 KINGS 13:4**

TRUE OR FALSE:

10. "Then his hand, which he stretched out toward him, withered, so that he could not pull it back to himself." **1 KINGS 13:4**

TRUE OR FALSE

11. "The altar also was split apart, and the ashes poured out from the altar, according to the sign which the man of God had given by the word of the LORD." **1 KINGS 13:5**

TRUE OR FALSE

12. Now the man of God would not entreat the LORD for the king and his hand remained withered. **1 KINGS 13:6**

TRUE OR FALSE

96. JEROBOAM MAKES TWO GOLDEN CALVES

(1 KINGS 12:25-13:6)

E S T W O R S H I P S I G N N
 P N P G R H B S I N W A S P B
 G Y O L R K K M V I A Z B T I
 G W Y I I M E L A S U R E J V
 L C N F S T N W B O M Y E G G
 Y E M N W E P W J N B E W O U
 S N A I A I C V K O H O G L K
 T D O Y U B T I C A S K H D J
 P R B M S M F H N A D I B E W
 V G O L V T R H E I L N A C R
 E I R E W S S A G R R V A H S
 N K E H A H H E T V E C E H F
 J N J T T J J W I L L D A S Z
 A T T E Z L K S P R A G T S Z
 H S T B V X Z R E I P Z D P E

ALTAR
 BETHEL
 CALVES
 DAN
 GOLD
 HAND

JEROBOAM
 JERUSALEM
 JOSIAH
 PRIESTS
 REHOBOAM
 SACRIFICES

SHRINES
 SIN
 SIGN
 SPLIT
 WITHERED
 WORSHIP

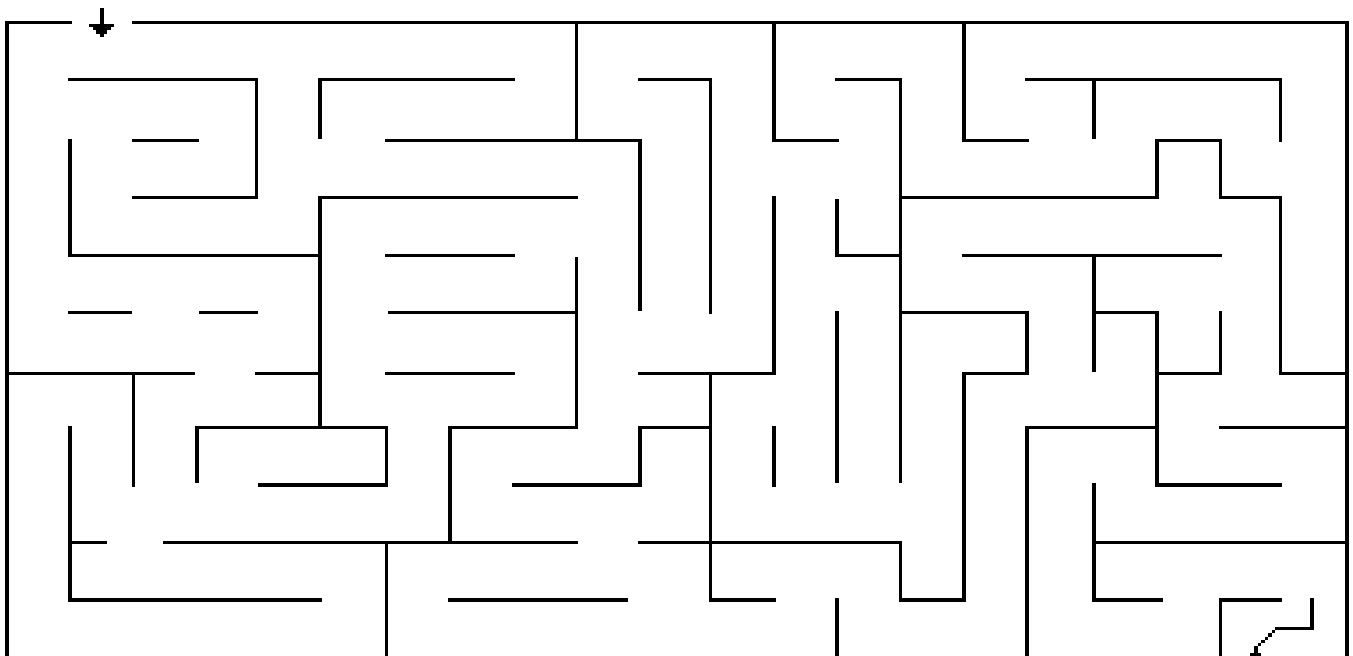

96. JEROBOAM MAKES TWO GOLDEN CALVES

(1 KINGS 12:25-13:6)

MEMORY VERSE:

"Now this thing became a sin, for the people went to worship before the one as far as Dan." 1 KINGS 13:30

FILL IN THE BLANKS:

1. "Jeroboam said in his heart, 'Now the kingdom may return to the house of David: if these people go up to offer sacrifices in the house of the LORD at _____, then the heart of this people will turn back to their lord, Rehoboam king of Judah, and they will kill me and go back to Rehoboam king of Judah.' " **1 KINGS 12:26-27**
2. "Therefore the king took counsel and made two _____ of gold, and said to the people, 'It is too much for you to go up to Jerusalem. Here are your gods, O Israel, which brought you up from the land of Egypt!' " **1 KINGS 12:28**
3. "And he set one up in _____, and the other he put in _____." **1 KINGS 12:29**
4. "Now this thing became a _____, for the people went to worship before the one as far as Dan." **1 KINGS 12:30**

TRUE OR FALSE:

5. "He made shrines on the high places, and made priests from every class of people, who were not of the sons of Levi." **1 KINGS 12:31**

TRUE OR FALSE

6. "Behold, a man of God went from Judah to Bethel by the word of the LORD, and Jeroboam stood by the altar to burn incense." **1 KINGS 13:1**

TRUE OR FALSE

FILL IN THE BLANKS:

7. "Then he cried out against the altar by the word of the LORD, and said, 'O altar, altar! Thus says the LORD: Behold, a child, _____ by name, shall be born to the house of David; and on you he shall sacrifice the priests of the high places who burn incense on you, and men's bones shall be burned on you.' " **1 KINGS 13:2**
8. "And he gave a sign the same day, saying, 'This is the sign which the LORD has spoken: Surely the _____ shall split apart, and ashes on it shall be poured out.' " **1 KINGS 13:3**
9. "So it came to pass when King Jeroboam heard the saying of the man of God, who cried out against the altar in Bethel, that he stretched out his _____ from the altar, saying, 'Arrest him!' **1 KINGS 13:4**

TRUE OR FALSE:

10. "Then his hand, which he stretched out toward him, withered, so that he could not pull it back to himself." **1 KINGS 13:4**

TRUE OR FALSE

11. "The altar also was split apart, and the ashes poured out from the altar, according to the sign which the man of God had given by the word of the LORD." **1 KINGS 13:5**

TRUE OR FALSE

12. Now the man of God would not entreat the LORD for the king and his hand remained withered. **1 KINGS 13:6**

TRUE OR FALSE

96. JEROBOAM MAKES TWO GOLDEN CALVES

(1 KINGS 12:25-13:6)

W U L M E L A S U R E J W O R S H I P N
 C H H J L M Y Z G B Q F M C S Q W W N I
 H B Z C Y Z A Y J B V M J E B T R B D S
 H S E W E C E O L V E C N Q V S S P L K
 O P S G Q I A R B K Y I A Y W C Q M O S
 F L Q M T N Z L D O R G P V Z T U A G U
 B I U A X T D B V H H J N F F B R B A L
 X T Z O B S N I S E B E W I T H E R E D
 Z P F B K Y A D A G S O R D O H G E P M
 G P N O S T H A C V P N E H J G L G E O
 N Y M R I G P M R S B N P A L A Y G U T
 X J F E S R A D I I N O B I N K F B R D
 C V I J N R U I F G Y X U S A E B E B A
 S T S E I R P R I N Q V U O Y N O T M N
 X T E G W K Y G C E Q E H J O C W H K J
 Z C V V J U E K E A F H Y Q P X X E N B
 A V M B N P D F S B A L T A R C C L X H
 K S N I K S K Q K Y E C J D X C W H H Z
 I H I N G Q J N G Z Z K A I E T A B A J
 L D M X A V Y I C R H Z L D A X V Y G L

ALTAR
 BETHEL
 CALVES
 DAN
 GOLD
 HAND

JEROBOAM
 JERUSALEM
 JOSIAH
 PRIESTS
 REHOBOAM
 SACRIFICES

SHRINES
 SIN
 SIGN
 SPLIT
 WITHERED
 WORSHIP

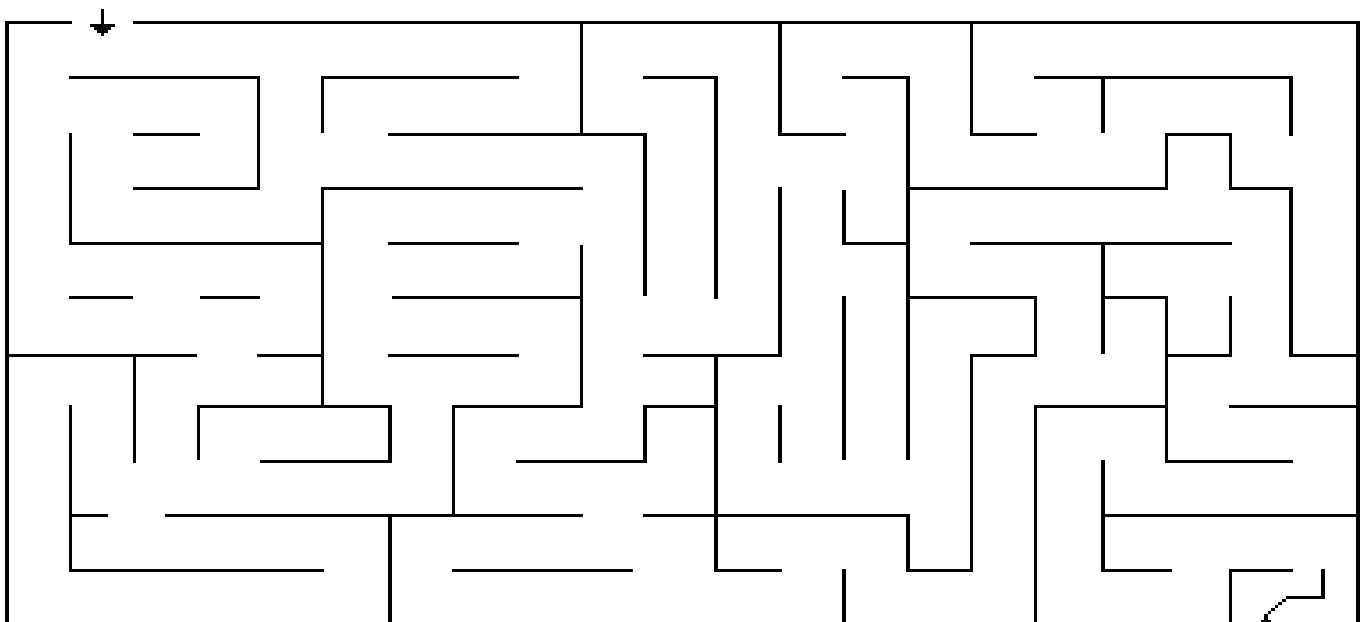

96. JEROBOAM MAKES TWO GOLDEN CALVES

(1 KINGS 12:25-13:6)

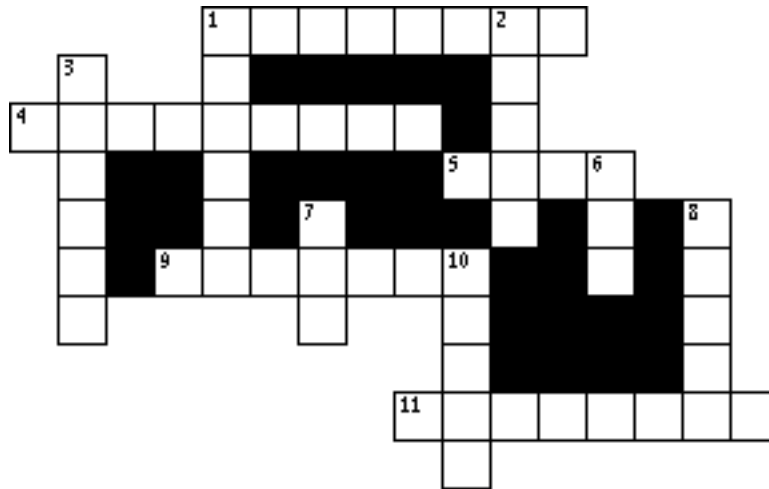

- 4 ACROSS "Jeroboam said in his heart, 'Now the kingdom may return to the house of David: if these people go up to offer sacrifices in the house of the LORD at ____.'" **1 KINGS 12:26-27**
- 8 DOWN "Therefore the king took counsel and made two ____ of gold." **1 KINGS 12:28**
- 3 DOWN "And he set one up in ____." **1 KINGS 12:29**
- 6 DOWN "And the other he put in ____." **1 KINGS 12:29**
- 7 DOWN "Now this thing became a _____, for the people went to worship before the one as far as Dan." **1 KINGS 12:30**
- 9 ACROSS "He made ____ on the high places, and made priests from every class of people, who were not of the sons of Levi." **1 KINGS 12:31**
- 1 ACROSS "Behold, a man of God went from Judah to Bethel by the word of the LORD, and ____ stood by the altar to burn incense." **1 KINGS 13:1**
- 1 DOWN "Then he cried out against the altar by the word of the LORD, and said, 'O altar, altar! Thus says the LORD: "Behold, a child, ____ by name, shall be born to the house of David." ' " **1 KINGS 13:2**
- 2 DOWN "And he gave a sign the same day, saying, 'This is the sign which the LORD has spoken: Surely the ____ shall split apart, and ashes on it shall be poured out.'" **1 KINGS 13:3**
- 5 ACROSS "So it came to pass when King Jeroboam heard the saying of the man of God, who cried out against the altar in Bethel, that he stretched out his _____ from the altar, saying, 'Arrest him!' **1 KINGS 13:4**
- 11 ACROSS "Then his hand, which he stretched out toward him, _____ so that he could not pull it back to himself." **1 KINGS 13:4**
- 10 DOWN "The altar also was _____ apart, and the ashes poured out from the altar, according to the sign which the man of God had given by the word of the LORD." **1 KINGS 13:5**

Bible Story 97

**THE RAVENS BRING
FOOD TO ELIJAH**

1 KINGS 17:1-17

97. THE RAVENS BRING FOOD TO ELIJAH

(1 KINGS 17:1-7)

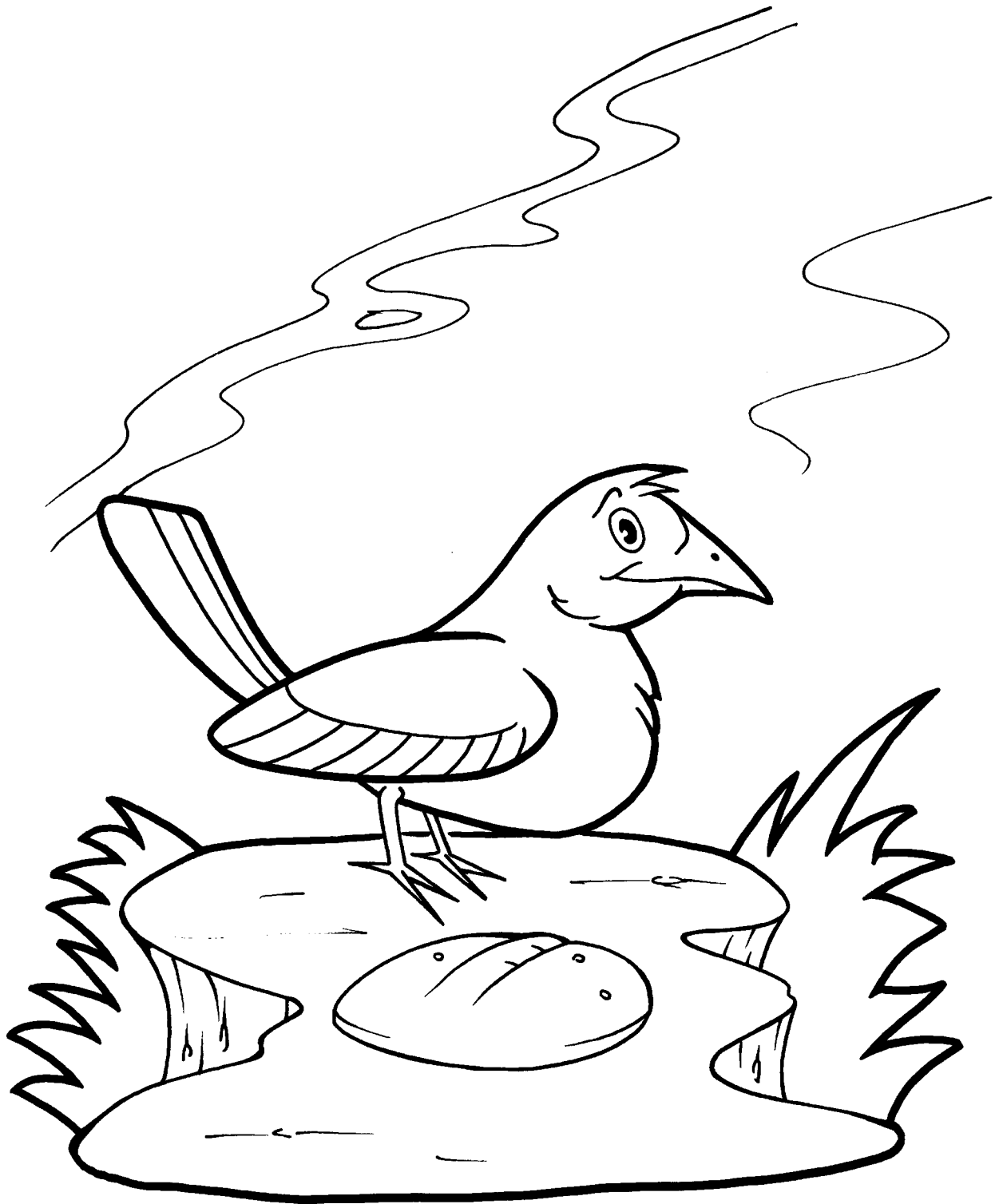

"The ravens brought him bread and meat in the morning, and bread and meat in the evening; and he drank from the brook."

1 KINGS 17:6

97. THE RAVENS BRING FOOD TO ELIJAH

(1 KINGS 17:1-7)

MEMORY VERSE:

"The ravens brought him bread and meat in the morning, and bread and meat in the evening; and he drank from the brook." 1 KINGS 17:6

FILL IN THE BLANKS:

1. "Elijah the Tishbite, of the inhabitants of Gilead, said to Ahab, 'As the LORD God of Israel lives, before whom I stand, there shall not be _____ nor _____ these years, except at my word.'" 1 KINGS 17:1

CIRCLE THE CORRECT WORDS:

2. "Then the word of the LORD came to him, saying, 'Get away from here and turn eastward, and hide by the Brook Cherith, which flows into the (OCEAN, JORDAN).'" 1 KINGS 17:2-3
3. "It will be that you shall drink from the brook, and I have commanded the (RAVENS, ROCKS) to feed you there." 1 KINGS 17:4

TRUE OR FALSE:

4. But he would not do according to the word of the LORD, for he would not go to the Brook Cherith, which flows into the Jordan. 1 KINGS 17:5
TRUE OR FALSE
5. "The ravens brought him bread and meat in the morning, and bread and meat in the evening." 1 KINGS 17:6
TRUE OR FALSE

CIRCLE THE CORRECT WORD:

6. "And he (SANK, DRANK) from the brook." 1 KINGS 17:6

TRUE OR FALSE:

7. "And it happened after a while that the brook dried up, because there had been no rain in the land." 1 KINGS 17:7
TRUE OR FALSE

97. THE RAVENS BRING FOOD TO ELIJAH

(1 KINGS 17:1-7)

X	N	I	A	R	T	P	M	S	Z
K	P	H	W	T	U	U	E	T	U
N	D	D	J	O	R	D	A	N	O
A	B	R	O	O	K	E	T	R	W
R	E	W	A	J	J	I	H	M	E
D	Q	L	L	V	Q	R	S	D	C
P	A	O	I	G	E	D	T	A	U
D	R	Y	G	J	K	N	O	E	C
D	F	N	Z	A	A	V	S	R	J
J	A	Z	T	Z	K	H	L	B	T

BREAD
BROOK
DRANK
DRIEDUP

ELIJAH
JORDAN
LORD

MEAT
RAIN
RAVENS

Bring food →
to Elijah

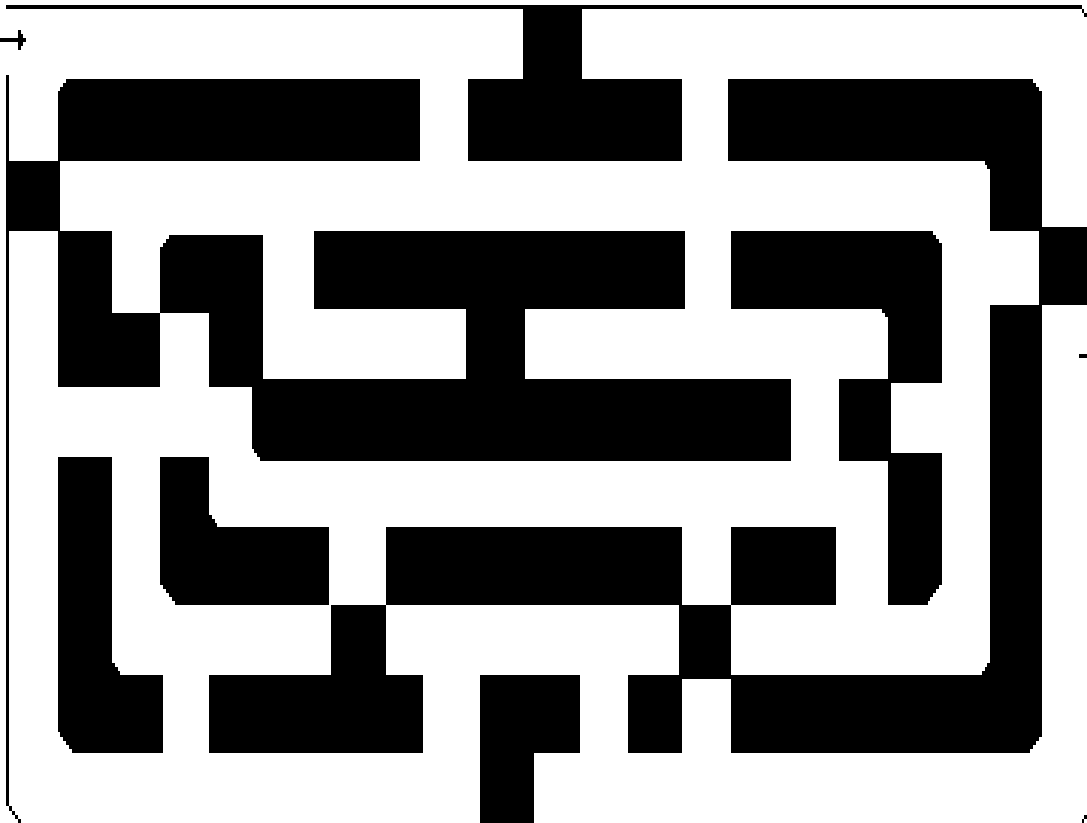

→ Elijah

97. THE RAVENS BRING FOOD TO ELIJAH

(1 KINGS 17:1-7)

MEMORY VERSE:

"The ravens brought him bread and meat in the morning, and bread and meat in the evening; and he drank from the brook." 1 KINGS 17:6

FILL IN THE BLANKS:

1. "Elijah the Tishbite, of the inhabitants of Gilead, said to Ahab, 'As the LORD God of Israel lives, before whom I stand, there shall not be _____ nor _____ these years, except at my word.'" **1 KINGS 17:1**
2. "Then the word of the LORD came to him, saying, 'Get away from here and turn eastward, and hide by the Brook Cherith, which flows into the _____.'" **1 KINGS 17:2-3**
3. "It will be that you shall drink from the brook, and I have commanded the _____ to feed you there." **1 KINGS 17:4**

TRUE OR FALSE:

4. But he would not do according to the word of the LORD, for he would not go to the Brook Cherith, which flows into the Jordan. **1 KINGS 17:5**
TRUE OR FALSE
5. "The ravens brought him bread and meat in the morning, and bread and meat in the evening." **1 KINGS 17:6**
TRUE OR FALSE

FILL IN THE BLANKS:

6. "And he _____ from the _____." **1 KINGS 17:6**

TRUE OR FALSE:

7. "And it happened after a while that the brook dried up, because there had been no rain in the land." **1 KINGS 17:7**
TRUE OR FALSE

97. THE RAVENS BRING FOOD TO ELIJAH

(1 KINGS 17:1-7)

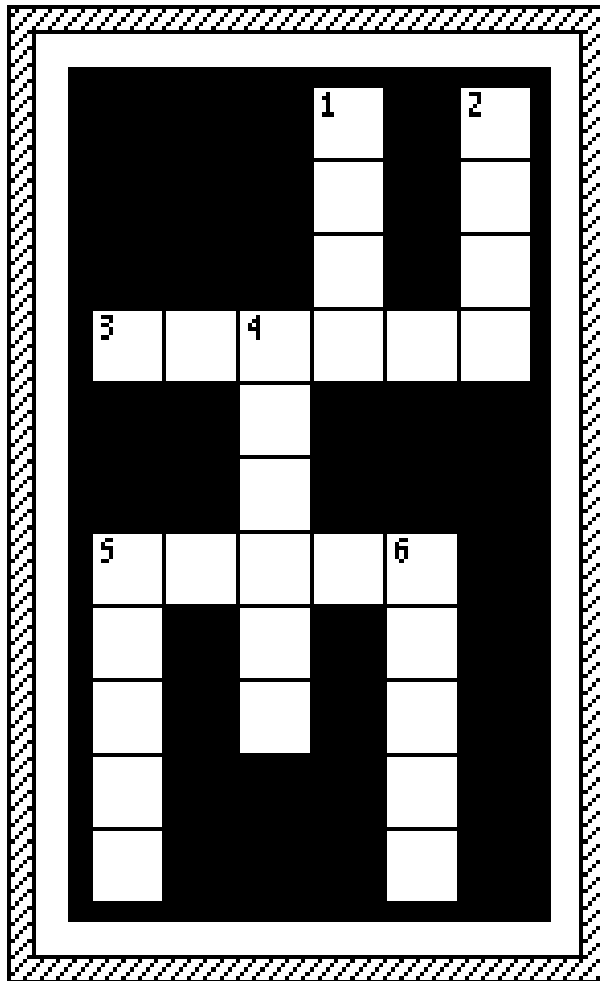

- 2 DOWN "Elijah the Tishbite, of the inhabitants of Gilead, said to Ahab, 'As the LORD God of Israel lives, before whom I stand, there shall not be dew nor _____ these years, except at my word.'" **1 KINGS 17:1**
- 3 ACROSS "Then the word of the LORD came to him, saying, 'Get away from here and turn eastward, and hide by the Brook Cherith, which flows into the _____.'" **1 KINGS 17:2-3**
- 4 DOWN "It will be that you shall drink from the brook, and I have commanded the _____ to feed you there." **1 KINGS 17:4**
- 1 DOWN "So he went and did according to the word of the _____, for he went and stayed by the Brook Cherith, which flows into the Jordan." **1 KINGS 17:5**
- 5 ACROSS "The ravens brought him _____ and meat in the morning, and bread and meat in the evening." **1 KINGS 17:6**
- 5 DOWN "And he drank from the _____." **1 KINGS 17:6**
- 6 DOWN "And it happened after a while that the brook _____ up, because there had been no rain in the land." **1 KINGS 17:7**

Bible Story 98

**ELIJAH HELPS A
POOR WIDOW**

1 KINGS 17:8-24

98. ELIJAH HELPS A POOR WIDOW

(1 KINGS 17:8-24)



"And he stretched himself upon the child three times, and cried unto the LORD, and said, O LORD my God, I pray thee, let this child's soul come into him again. And the LORD heard the voice of Elijah; and the soul of the child came into him again, and he revived."

1 KINGS 17:21

98. ELIJAH HELPS A POOR WIDOW

(1 KINGS 17:8-24)

MEMORY VERSE:

"So she went away and did according to the word of Elijah; and she and he and her household ate for many days." 1 KINGS 17:15

CIRCLE THE CORRECT WORD:

1. "The word of the LORD came to him, saying, 'Arise, go to Zarephath, which belongs to Sidon, and dwell there. See, I have commanded a (**KING, WIDOW**) there to provide for you.'" 1 KINGS 17:8-9

TRUE OR FALSE:

2. "When he came to the gate of the city, indeed a widow was there gathering sticks." 1 KINGS 17:10
TRUE OR FALSE

CIRCLE THE CORRECT WORDS:

3. "He called to her and said, 'Please bring me a little (**WATER, JUICE**) in a cup, that I may drink.' And as she was going to get it, he called to her and said, 'Please bring me a morsel of (**STONES, BREAD**) in your hand.'" 1 KINGS 17:10-11
4. "Then she said, 'As the LORD your God lives, I do not have bread, only a handful of flour in a bin, and a little oil in a jar; and see, I am gathering a couple of sticks that I may go in and prepare it for myself and my son, that we may eat it, and (**CRY, DIE**).'" 1 KINGS 17:12

TRUE OR FALSE:

5. "Elijah said to her, 'Do not fear; go and do as you have said, but make me a small cake from it first, and bring it to me; and afterward make some for yourself and your son.'" 1 KINGS 17:13
TRUE OR FALSE

FILL IN THE BLANKS:

6. "For thus says the LORD God of Israel: 'The bin of _____ shall not be used up, nor shall the jar of _____ run dry, until the day the LORD sends rain on the earth.'" 1 KINGS 17:14

CIRCLE THE CORRECT WORD:

7. "Now it happened after these things that the son of the woman who owned the house became sick. And his sickness was so serious that there was no (**BREATH, FOOD**) left in him." 1 KINGS 17:17

TRUE OR FALSE:

8. Elijah "stretched himself out on the child three times, and cried out to the LORD and said, 'O LORD my God, I pray, let this child's soul come back to him.'" 1 KINGS 17:21
TRUE OR FALSE
9. But the LORD did not hear the voice of Elijah. 1 KINGS 17:22
TRUE OR FALSE
10. "The soul of the child came back to him, and he revived." 1 KINGS 17:22
TRUE OR FALSE

FILL IN THE BLANK:

11. "And Elijah took the child and brought him down from the upper room into the house, and gave him to his mother. And Elijah said, 'See, your son _____!'" 1 KINGS 17:23

98. ELIJAH HELPS A POOR WIDOW

(1 KINGS 17:8-24)

G W L B R P D R A E H Z J B Y
F I N F L T H O E G S Z U C C
F J T O B I M R E M W M B E A
X Q H V H H Z B D V A Y O O K
V H T L U O S B C S W A Y W E
W L A M S I C K C S W R D N S
Q H P J F N D T H P Z P A O S
T N F T I N C C T L W M U S O
C G L F D L V N A I O I Q P I
Y I O W D S E P E V B M D S B
O I U Y W K E O R E P R T O K
N N R A V Y K J B S A I E Y W
K T T F D L X T L A C I C A G
K E N E M N Z Z G K W X N V D
R M C D V O B D S V V O L Z L

BREAD

HEARD

SON

BREATH

LIVES

SOUL

CAKE

OIL

STICKS

ELIJAH

PRAY

WATER

FLOUR

SICK

WIDOW

98. ELIJAH HELPS A POOR WIDOW

(1 KINGS 17:8-24)

MEMORY VERSE:

"So she went away and did according to the word of Elijah; and she and he and her household ate for many days." 1 KINGS 17:15

FILL IN THE BLANK:

1. "The word of the LORD came to him, saying, 'Arise, go to Zarephath, which belongs to Sidon, and dwell there. See, I have commanded a _____ there to provide for you.'" 1 KINGS 17:8-9

TRUE OR FALSE:

2. "When he came to the gate of the city, indeed a widow was there gathering sticks." 1 KINGS 17:10
TRUE OR FALSE

FILL IN THE BLANKS:

3. "He called to her and said, 'Please bring me a little _____ in a cup, that I may drink.' And as she was going to get it, he called to her and said, 'Please bring me a morsel of _____ in your hand.'" 1 KINGS 17:10-11
4. "Then she said, 'As the LORD your God lives, I do not have bread, only a handful of flour in a bin, and a little oil in a jar; and see, I am gathering a couple of sticks that I may go in and prepare it for myself and my son, that we may eat it, and _____.'" 1 KINGS 17:12

TRUE OR FALSE:

5. "Elijah said to her, 'Do not fear; go and do as you have said, but make me a small cake from it first, and bring it to me; and afterward make some for yourself and your son.'" 1 KINGS 17:13
TRUE OR FALSE

FILL IN THE BLANKS:

6. "For thus says the LORD God of Israel: 'The bin of _____ shall not be used up, nor shall the jar of _____ run dry, until the day the LORD sends rain on the earth.'" 1 KINGS 17:14
7. "Now it happened after these things that the son of the woman who owned the house became sick. And his sickness was so serious that there was no _____ left in him." 1 KINGS 17:17

TRUE OR FALSE:

8. Elijah "stretched himself out on the child three times, and cried out to the LORD and said, 'O LORD my God, I pray, let this child's soul come back to him.'" 1 KINGS 17:21
TRUE OR FALSE
9. But the LORD did not hear the voice of Elijah. 1 KINGS 17:22
TRUE OR FALSE
10. "The soul of the child came back to him, and he revived." 1 KINGS 17:22
TRUE OR FALSE

FILL IN THE BLANK:

11. "And Elijah took the child and brought him down from the upper room into the house, and gave him to his mother. And Elijah said, 'See, your son _____!'" 1 KINGS 17:23

98. ELIJAH HELPS A POOR WIDOW

(1 KINGS 17:8-24)

E K J K V C C R K T K Q K J O N A F U P
L T Q S D A T A O Q S U I W M C S L W A
M G S K D L W Z B F L O U R J V V Y Q D
G E C P E O C O H H M Q E S K C Y H N Y
M I P P Z L J E D A J T P N O S K X I S
S Y M R Z Z I M F I T H I S R E T A W M
B G B X O M W J V U W T Y B G C W O S U
P M B O W F Y D A U A T B R H D L I V M
M Q O S H M J W D H A R B E G A W R U S
W H H L Q Q T Q I R U R P A D E W O I L
N C S K I S N N O T A W P T V R Z F U E
G V A W L S A I N T E E Y H B B O Y A J
K V S K H Q T T H D N P H I G H A X D M
B G R V E V S I L U O S S A C R N D D G
Y S V J T P L A C D Q N E G Z E U F W O
K N N X Y B P L I K B K V W H M N B T V
P B G W O Y U B U Q S B I A K Q U E L S
U K D E A Q T Z A C N C L F N N D H A P
Y K P R A J N Z N U A D F U R Y L T O T
M O P L V I D N N J Y W O T E M U L A W

BREAD

HEARD

SON

BREATH

LIVES

SOUL

CAKE

OIL

STICKS

ELIJAH

PRAY

WATER

FLOUR

SICK

WIDOW

98. ELIJAH HELPS A POOR WIDOW (1 KINGS 17:8-24)

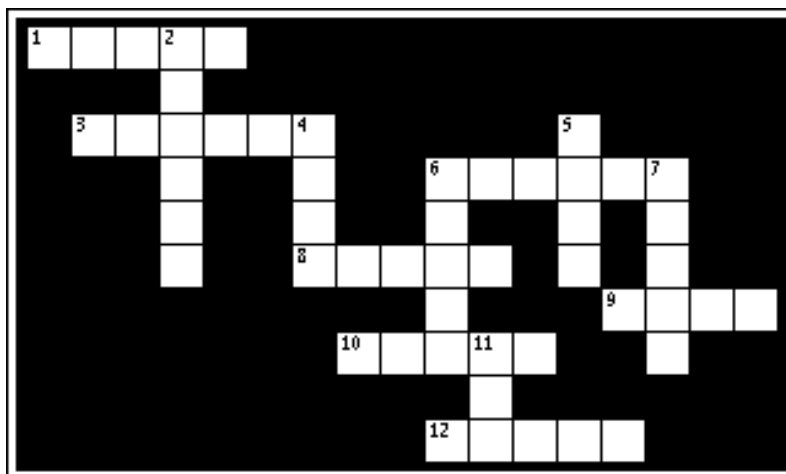

- 10 ACROSS "The word of the LORD came to him, saying, 'Arise, go to Zarephath, which belongs to Sidon, and dwell there. See, I have commanded a _____ there to provide for you.'" **1 KINGS 17:8-9**
- 3 ACROSS "When he came to the gate of the city, indeed a widow was there gathering _____." **1 KINGS 17:10**
- 1 ACROSS "He called to her and said, 'Please bring me a little _____ in a cup, that I may drink.'" **1 KINGS 17:10**
- 6 DOWN "And as she was going to get it, he called to her and said, 'Please bring me a morsel of _____ in your hand.'" **1 KINGS 17:11**
- 11 ACROSS "Then she said, 'As the LORD your God lives, I do not have bread, only a handful of _____ in a bin.'" **1 KINGS 17:12**
- 5 DOWN "Elijah said to her, 'Do not fear; go and do as you have said, but make me a small _____ from it first, and bring it to me; and afterward make some for yourself and your son.'" **1 KINGS 17:13**
- 11 DOWN "For thus says the LORD God of Israel: 'The bin of flour shall not be used up, nor shall the jar of _____ run dry, until the day the LORD sends rain on the earth.'" **1 KINGS 17:14**
- 2 DOWN "So she went away and did according to the word of _____; and she and he and her household ate for many days." **1 KINGS 17:15**
- 6 ACROSS "Now it happened after these things that the son of the woman who owned the house became sick. And his sickness was so serious that there was no _____ left in him." **1 KINGS 17:17**
- 9 ACROSS Elijah "stretched himself out on the child three times, and cried out to the LORD and said, 'O LORD my God, I _____, let this child's soul come back to him.'" **1 KINGS 17:21**
- 7 DOWN "Then the LORD _____ the voice of Elijah." **1 KINGS 17:22**
- 4 DOWN "The _____ of the child came back to him, and he revived." **1 KINGS 17:22**
- 8 ACROSS "And Elijah took the child and brought him down from the upper room into the house, and gave him to his mother. And Elijah said, 'See, your son _____!'" **1 KINGS 17:23**

Bible Story 99

**ELIJAH DEFEATS
THE PROPHETS
OF BAAL**

1 KINGS 18:17-40

99. ELIJAH DEFEATS THE PROPHETS OF BAAL

(1 KINGS 18:1-40)



"Hear me, O LORD, hear me, that this people may know that thou *art* the LORD God, and *that* thou hast turned their heart back again. Then the fire of the LORD fell, and consumed the burnt sacrifice, and the wood, and the stones, and the dust, and licked up the water that *was* in the trench."

1 KINGS 18:37-38

99. ELIJAH DEFEATS THE PROPHETS OF BAAL

(1 KINGS 18:1-40)

MEMORY VERSE:

"Now when all the people saw it, they fell on their faces; and they said, 'The LORD, He is God! The LORD, He is God!' " 1 KINGS 18:39

CIRCLE THE CORRECT WORDS:

1. "Now it came to pass after many days that the word of the LORD came to Elijah, in the third year, saying, 'Go, present yourself to Ahab, and I will send (**RAIN, SNOW**) on the earth.' " 1 KINGS 18:1
2. "Then it happened, when Ahab saw Elijah, that Ahab said to him, 'Is that you, O (**BUBBLER, TROUBLER**) of Israel?' " 1 KINGS 18:17
3. "He answered, 'I have not troubled Israel, but you and your father's house have, in that you have (**FORSAKEN, KEPT**) the commandments of the LORD, and you have followed the Baals.' "1 KINGS 18:18

TRUE OR FALSE:

4. Elijah said to Ahab, "Now therefore, send and gather all Israel to me on Mount Carmel, the four hundred and fifty prophets of Baal, and the four hundred prophets of Asherah, who eat at Jezebel's table." 1 KINGS 18:19
TRUE OR FALSE
5. But Ahab would not send for all the children of Israel, nor would he gather the prophets together on Mount Carmel. 1 KINGS 18:20
TRUE OR FALSE
6. "And Elijah came to all the people, and said, 'How long will you falter between two opinions? If the LORD is God, follow Him; but if Baal, then follow him.' " 1 KINGS 18:21
TRUE OR FALSE

CIRCLE THE CORRECT WORDS:

7. "Therefore let them give us two bulls; and let them choose one bull for themselves, cut it in pieces, and lay it on the wood, but put (**A, NO**) fire under it; and I will prepare the other bull, and lay it on the wood, but put (**A, NO**) fire under it." 1 KINGS 18:23
8. " 'Then you call on the name of your gods, and I will call on the name of the LORD; and the God who answers by (**RAIN, FIRE**), He is God.' So all the people answered and said, 'It is well spoken.' "1 KINGS 18:24

TRUE OR FALSE:

9. "So they took the bull which was given them, and they prepared it, and called on the name of Baal from morning even till noon, saying, 'O Baal, hear us!' But there was no voice; no one answered." 1 KINGS 18:26
TRUE OR FALSE
10. When it was Elijah's turn, he prayed to the LORD, " 'Hear me, O LORD, hear me, that this people may know that You are the LORD God, and that You have turned their hearts back to You again.' Then the fire of the LORD fell and consumed the burnt sacrifice, and the wood and stones and the dust, and it licked up the water that was in the trench." 1 KINGS 18:37-38
TRUE OR FALSE
11. "Now when all the people saw it, they fell on their faces; and they said, 'The LORD, He is God! The LORD, He is God!' And Elijah said to them, 'Seize the prophets of Baal! Do not let one of them escape!' So they seized them; and Elijah brought them down to the Brook Kishon and executed them there." 1 KINGS 18:39-40
TRUE OR FALSE

99. ELIJAH DEFEATS THE PROPHETS OF BAAL

(1 KINGS 18:1-40)

R R D F I R E V P F H Z V X P
 C E O Z L Y I S R A E L B H L
 L R O O D N S F R R Y U W M O
 P V R S K E C I F I R C A S P
 R D K T L J E Z E B E L Y G D
 E T D V P E O I R C G U U Q H
 M O E G A R M U E G M A H A B
 H J M W G F O R N O X I J W Q
 Y Q U A S L E P A W U I K G J
 Y L S T A K Z N H C L X Y X J
 M P N E U I P I A E T Q H W C
 B V O R K Q E A I J T N F D X
 P G C A S H E R A H V S U I V
 R Y P W S S U H P V E B N O D
 Y Q S L L U B I Q L A A B C M

AHAB
 ASHERAH
 BAAL
 BULLS
 CONSUMED

ELIJAH
 FIRE
 ISRAEL
 JEZEBEL
 LORD

MOUNT CARMEL
 PROPHETS
 RAIN
 SACRIFICE
 WATER

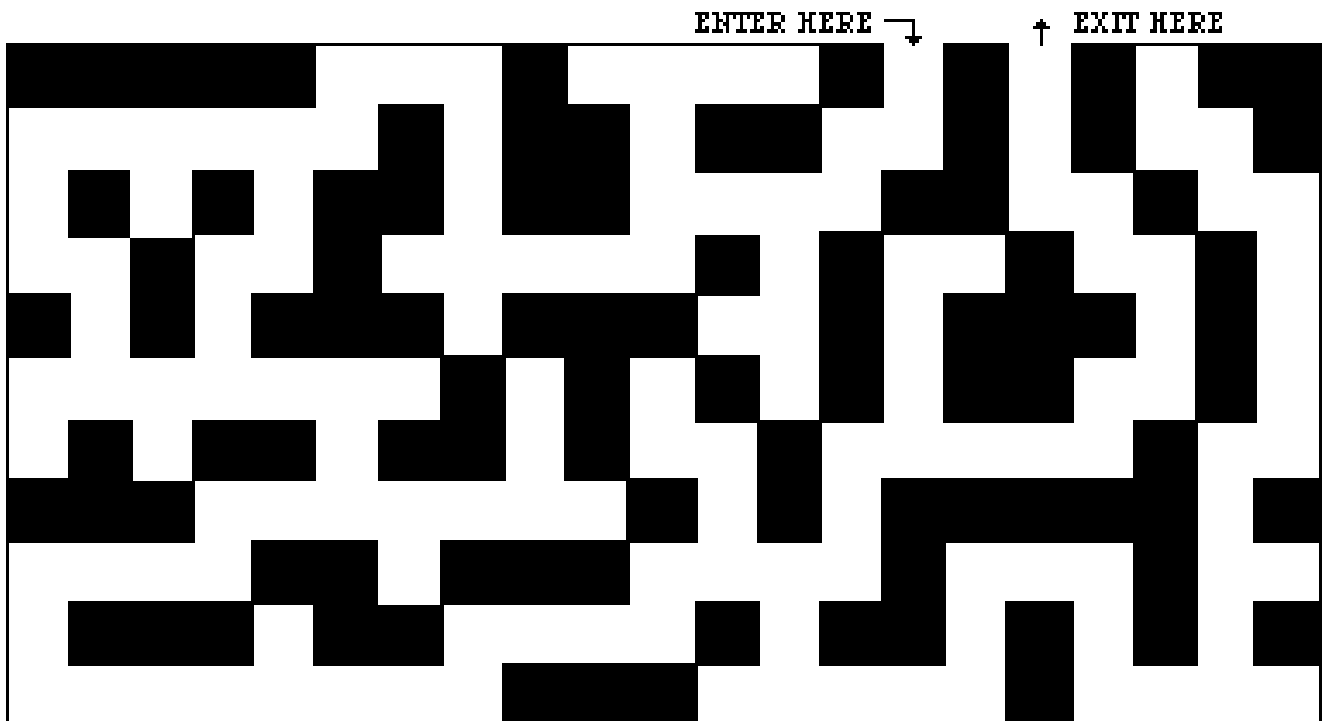

99. ELIJAH DEFEATS THE PROPHETS OF BAAL

(1 KINGS 18:1-40)

MEMORY VERSE:

"Now when all the people saw it, they fell on their faces; and they said, 'The LORD, He is God! The LORD, He is God!' " 1 KINGS 18:39

FILL IN THE BLANKS:

1. "Now it came to pass after many days that the word of the LORD came to Elijah, in the third year, saying, 'Go, present yourself to Ahab, and I will send _____ on the earth.' " 1 KINGS 18:1
2. "Then it happened, when Ahab saw Elijah, that Ahab said to him, 'Is that you, O _____ of Israel?' " 1 KINGS 18:17
3. "He answered, 'I have not troubled Israel, but you and your father's house have, in that you have _____ the commandments of the LORD, and you have followed the Baals.' "1 KINGS 18:18

TRUE OR FALSE:

4. Elijah said to Ahab, "Now therefore, send and gather all Israel to me on Mount Carmel, the four hundred and fifty prophets of Baal, and the four hundred prophets of Asherah, who eat at Jezebel's table." 1 KINGS 18:19
TRUE OR FALSE
5. But Ahab would not send for all the children of Israel, nor would he gather the prophets together on Mount Carmel. 1 KINGS 18:20
TRUE OR FALSE
6. "And Elijah came to all the people, and said, 'How long will you falter between two opinions? If the LORD is God, follow Him; but if Baal, then follow him.' " 1 KINGS 18:21
TRUE OR FALSE

FILL IN THE BLANKS:

7. "Therefore let them give us two bulls; and let them choose one bull for themselves, cut it in pieces, and lay it on the wood, but put _____ fire under it; and I will prepare the other bull, and lay it on the wood, but put _____ fire under it." 1 KINGS 18:23
8. " 'Then you call on the name of your gods, and I will call on the name of the LORD; and the God who answers by _____, He is God.' So all the people answered and said, 'It is well spoken.' "1 KINGS 18:24

TRUE OR FALSE:

9. "So they took the bull which was given them, and they prepared it, and called on the name of Baal from morning even till noon, saying, 'O Baal, hear us!' But there was no voice; no one answered." 1 KINGS 18:26
TRUE OR FALSE
10. When it was Elijah's turn, he prayed to the LORD, " 'Hear me, O LORD, hear me, that this people may know that You are the LORD God, and that You have turned their hearts back to You again.' Then the fire of the LORD fell and consumed the burnt sacrifice, and the wood and stones and the dust, and it licked up the water that was in the trench." 1 KINGS 18:37-38
TRUE OR FALSE
11. "Now when all the people saw it, they fell on their faces; and they said, 'The LORD, He is God! The LORD, He is God!' And Elijah said to them, 'Seize the prophets of Baal! Do not let one of them escape!' So they seized them; and Elijah brought them down to the Brook Kishon and executed them there." 1 KINGS 18:39-40
TRUE OR FALSE

99. ELIJAH DEFEATS THE PROPHETS OF BAAL

(1 KINGS 18:1-40)

U B B H Y K K A M Q P N F W X I G Y T W
 O A Y D G J N K N J P G E H K P N K C X
 V X K T H Q M I Q V R I O H K M W E U L
 V H L N S X G Y Q Q B C R B X W B O V R
 R P Y E E Z G T H D N N I H A R E H S A
 F T T Y A P T L V L G E Y A D L W J C Q
 W Q P B Q R E F E E A B S J O G B O N C
 P R S P M Q S Z C M B A Y I F S N S V R
 W O J L B L L I Z D R P B L X S S Z M H
 V N V U X A F B S D L A D E U Z L N U N
 G C D L C I S T U L L U C M Q R L W O N
 J X T N R L E C O V E U E T R O U I X V
 T B T C B H V R D R N D Y X N J B L M G
 F I A Z P L D S I V X R B B K U E O G R
 G S Q O B M P F F D Z J O U D B O V Q K
 J F R H Y S Z L H K S Z J L E L V M O Z
 W P F R U O S S N X V A C Z F L B M T L
 J A N A W A M I G S H F E Y H A H G H X
 H W F A D L A N U A M J V L L G C D K I
 G X T J O R B P B H O J G H D H O O W V

AHAB
 ASHERAH
 BAAL
 BULLS
 CONSUMED

ELIJAH
 FIRE
 ISRAEL
 JEZEBEL
 LORD

MOUNT CARMEL
 PROPHETS
 RAIN
 SACRIFICE
 WATER

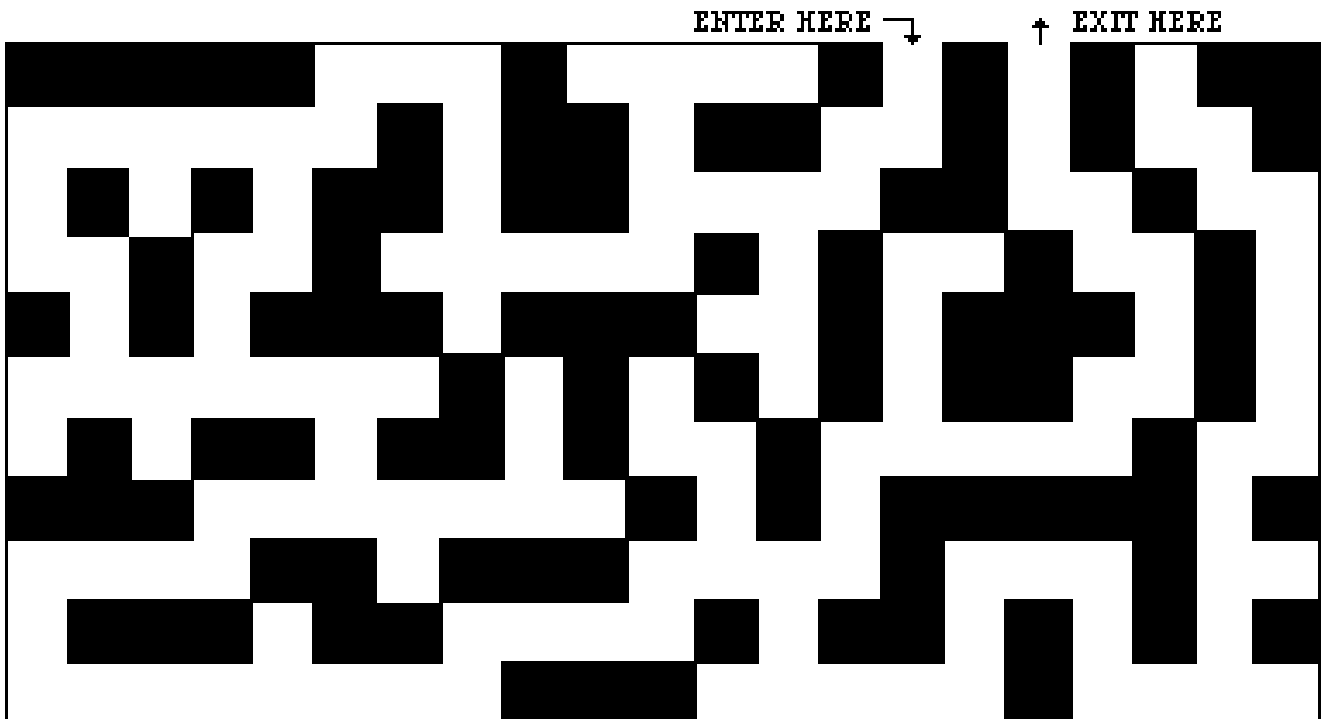

99. ELIJAH DEFEATS THE PROPHETS OF BAAL

(1 KINGS 18:1-40)

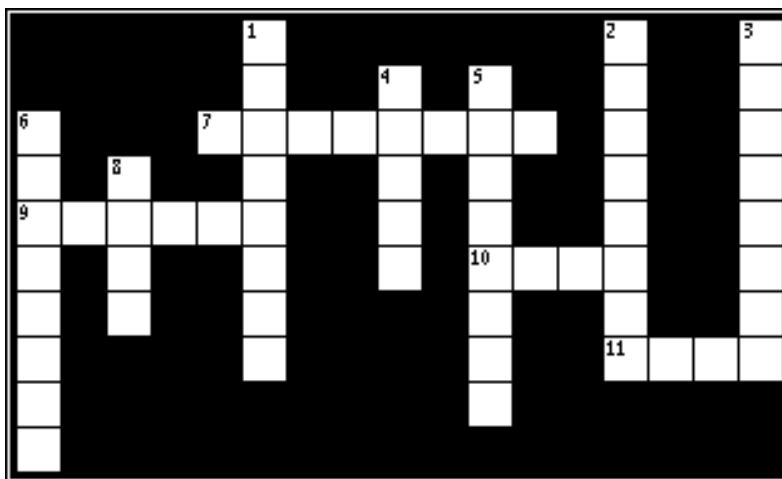

- 11 ACROSS "The word of the LORD came to Elijah, in the third year, saying, 'Go, present yourself to Ahab, and I will send _____ on the earth.'" **1 KINGS 18:1**
- 2 DOWN "Then it happened, when Ahab saw Elijah, that Ahab said to him, 'Is that you, O _____ of Israel?'" **1 KINGS 18:17**
- 3 DOWN "He answered, 'I have not troubled Israel, but you and your father's house have, in that you have _____ the commandments of the LORD, and you have followed the Baals.'" **1 KINGS 18:18**
- 5 DOWN Elijah said to Ahab, "Now therefore, send and gather all Israel to me on Mount Carmel, the four hundred and fifty prophets of Baal, and the four hundred prophets of Asherah, who eat at _____ table." **1 KINGS 18:19**
- 1 DOWN "So Ahab sent for all the children of Israel, and gathered the _____ together on Mount Carmel." **1 KINGS 18:20**
- 9 ACROSS "And _____ came to all the people, and said, 'How long will you falter between two opinions? If the LORD is God, follow Him; but if Baal, then follow him.'" **1 KINGS 18:21**
- 4 DOWN "Therefore let them give us two _____; and let them choose one bull for themselves, cut it in pieces, and lay it on the wood, but put no fire under it." **1 KINGS 18:23**
- 8 DOWN "'Then you call on the name of your gods, and I will call on the name of the LORD; and the God who answers by _____, He is God.' So all the people answered and said, 'It is well spoken.'" **1 KINGS 18:24**
- 10 ACROSS "So they took the bull which was given them, and they prepared it, and called on the name of _____ from morning even till noon." **1 KINGS 18:26**
- 7 ACROSS "The fire of the LORD fell and _____ the burnt sacrifice, and the wood and stones and the dust, and it licked up the water that was in the trench." **1 KINGS 18:37-38**
- 6 DOWN "Elijah said to them, 'Seize the prophets of Baal! Do not let one of them escape!' So they seized them; and Elijah brought them down to the Brook Kishon and _____ them there." **1 KINGS 18:40**

Bible Story 100

**THE STILL
SMALL VOICE**

1 KINGS 19:1-18

100. THE STILL SMALL VOICE

(1 KINGS 19:11-18)



"And it was so, when Elijah heard *it*, that he wrapped his face in his mantle, and went out, and stood in the entering in of the cave. And, behold, *there came* a voice unto him, and said, What doest thou here, Elijah?"

1 KINGS 19:13

100. THE STILL SMALL VOICE

(1 KINGS 19:11-18)

MEMORY VERSE:

"And behold, the LORD passed by, and a great and strong wind tore into the mountains and broke the rocks in pieces before the LORD, but the LORD was not in the wind; and after the wind an earthquake, but the LORD was not in the earthquake; and after the earthquake a fire, but the LORD was not in the fire; and after the fire a still small voice." 1 KINGS 19:11-12

TRUE OR FALSE:

1. The LORD God said to Elijah, "Go out, and stand on the mountain before the LORD." **1 KINGS 19:11**
TRUE OR FALSE

CIRCLE THE CORRECT WORDS:

2. "Behold, the LORD passed by, and a great and strong (**WIND, CRANE**) tore into the mountains and broke the rocks in pieces before the LORD." **1 KINGS 19:11**
3. "The LORD (**WAS, WAS NOT**) in the wind." **1 KINGS 19:11**
4. "After the wind an (**EARTHQUAKE, TIDAL WAVE**)." **1 KINGS 19:11**
5. "The LORD (**WAS, WAS NOT**) in the earthquake." **1 KINGS 19:11**
6. "After the earthquake a (**FIRE, FEAST**)." **1 KINGS 19:12**
7. "The LORD (**WAS, WAS NOT**) in the fire." **1 KINGS 19:12**
8. "After the fire a still small (**VOICE, MOUSE**)." **1 KINGS 19:12**

FILL IN THE BLANK:

9. "So it was, when Elijah heard it, that he wrapped his face in his _____ and went out and stood in the entrance of the cave." **1 KINGS 19:13**

TRUE OR FALSE:

10. "And suddenly a voice came to him, and said, 'What are you doing here, Elijah?'" **1 KINGS 19:13**
TRUE OR FALSE

FILL IN THE BLANK:

11. Elijah said, "I have been very zealous for the LORD God of hosts; because the children of Israel have forsaken your covenant, torn down Your altars, and killed Your prophets with the sword. I _____ am left; and they seek to take my life." **1 KINGS 19:14**

CIRCLE THE CORRECT WORD:

12. The LORD said to Elijah, "I have reserved seven thousand in Israel, all whose knees have not (**LOOKED, BOWED**) to Baal, and every mouth that has not kissed him." **1 KINGS 19:18**

100. THE STILL SMALL VOICE

(1 KINGS 19:11-18)

B H S G G E Q L P Y T W Z H T
Y V P D S S M O U N T A I N D
K E M E W T I O B J N Q N I D
P V N O A L E C A V E C I O V
U G R O O R L H Q T D X K U Q
Y D B P L V T Z P N R I O A C
F S B K S A H H J O A T B N U
K N O D L D H A Q E R A H N J
T B H N K D T M J U R P F T K
G B O I W Z Y F I I A I V Q S
E K S W V Z O M C A L K F H M
Y K S S E O A Q T S Z E E A J
G O R P J D V S C L E L I U T
M J V P X W C Q J P M B O U A
L O R D W H A V W U D Z N T A

ALONE
BOWED
CAVE
EARTHQUAKE

ELIJAH
FIRE
MOUNTAIN
PROPHETS

SWORD
VOICE
WIND
LORD

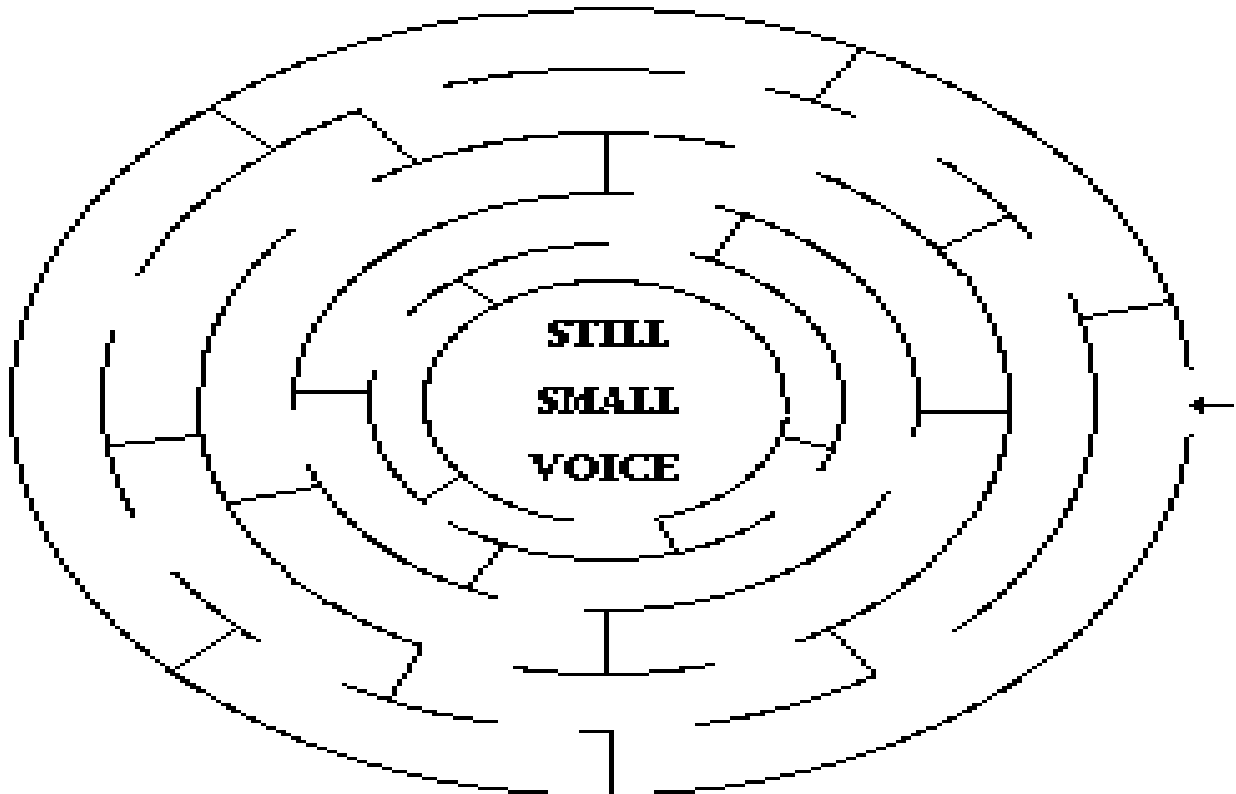

100. THE STILL SMALL VOICE

(1 KINGS 19:11-18)

MEMORY VERSE:

"And behold, the LORD passed by, and a great and strong wind tore into the mountains and broke the rocks in pieces before the LORD, but the LORD was not in the wind; and after the wind an earthquake, but the LORD was not in the earthquake; and after the earthquake a fire, but the LORD was not in the fire; and after the fire a still small voice." 1 KINGS 19:11-12

TRUE OR FALSE:

1. The LORD God said to Elijah, "Go out, and stand on the mountain before the LORD." **1 KINGS 19:11**
TRUE OR FALSE

FILL IN THE BLANK:

2. "Behold, the LORD passed by, and a great and strong _____ tore into the mountains and broke the rocks in pieces before the LORD." **1 KINGS 19:11**

CIRCLE THE CORRECT WORD(S):

3. "The LORD (**WAS, WAS NOT**) in the wind." **1 KINGS 19:11**

FILL IN THE BLANK:

4. "After the wind an _____." **1 KINGS 19:11**

CIRCLE THE CORRECT WORD(S):

5. "The LORD (**WAS, WAS NOT**) in the earthquake." **1 KINGS 19:11**

FILL IN THE BLANK:

6. "After the earthquake a _____." **1 KINGS 19:12**

CIRCLE THE CORRECT WORD(S):

7. "The LORD (**WAS, WAS NOT**) in the fire." **1 KINGS 19:12**

FILL IN THE BLANK:

8. "After the fire a still small _____." **1 KINGS 19:12**

TRUE OR FALSE:

9. "So it was, when Elijah heard it, that he wrapped his face in his mantle and went out and stood in the entrance of the cave." **1 KINGS 19:13**

TRUE OR FALSE

10. "And suddenly a voice came to him, and said, 'What are you doing here, Elijah?'" **1 KINGS 19:13**
TRUE OR FALSE

FILL IN THE BLANKS:

11. Elijah said, "I have been very zealous for the LORD God of hosts; because the children of Israel have forsaken your covenant, torn down Your altars, and killed Your prophets with the sword. I _____ am left; and they seek to take my life." **1 KINGS 19:14**

12. The LORD said to Elijah, "I have reserved seven thousand in Israel, all whose knees have not _____ to Baal, and every mouth that has not kissed him." **1 KINGS 19:18**

100. THE STILL SMALL VOICE

(1 KINGS 19:11-18)

E M R E C I O V L L A M S L L I T S P J
 A A O P O S C N Z E Z W K T D D D E F A
 A U M V V Y T O G J R G S E P A N R M P
 Q L Q M L D P E F V F I W S A O K Q C N
 X M D V C H L W H T N O F Y L M G V G E
 P I T E E I R K X P B G I A U D C E J P
 F F O K G I Z I C C O V S T Y I B Y O X
 M L U A V A P Z X V M R M O U N T A I N
 G G C U T L D A Z S F B P G E R B B X U
 E X H Q Y N H A A H I I D R C G V P F U
 W Y E H E F M W K D E N X R D A K B O H
 K V Q T R R Y C I L I F W K K K V N X Y
 R Z J R B D U H L W V X J M J F G E V J
 G Y X A W K K H U H M L F P Y Q V Y E A
 U U B E I S S E H Z N Y K S Z N E Q H L
 J V H O B F L O B E I E G Q Y I A Q C C
 A M Z T U I S D R O L Q A V R G B F K Q
 H Y Y J J X V F P S M T Z Y D R O W S Y
 P A Q A W Y Y B P Q J X I E B J Y E Z V
 R J H Z N D Z X Y U C B N Z I L Z Z M F

ALONE
 BOWED
 CAVE
 EARTHQUAKE

ELIJAH
 FIRE
 LORD
 MOUNTAIN

PROPHETS
 STILL SMALL VOICE
 SWORD
 WIND

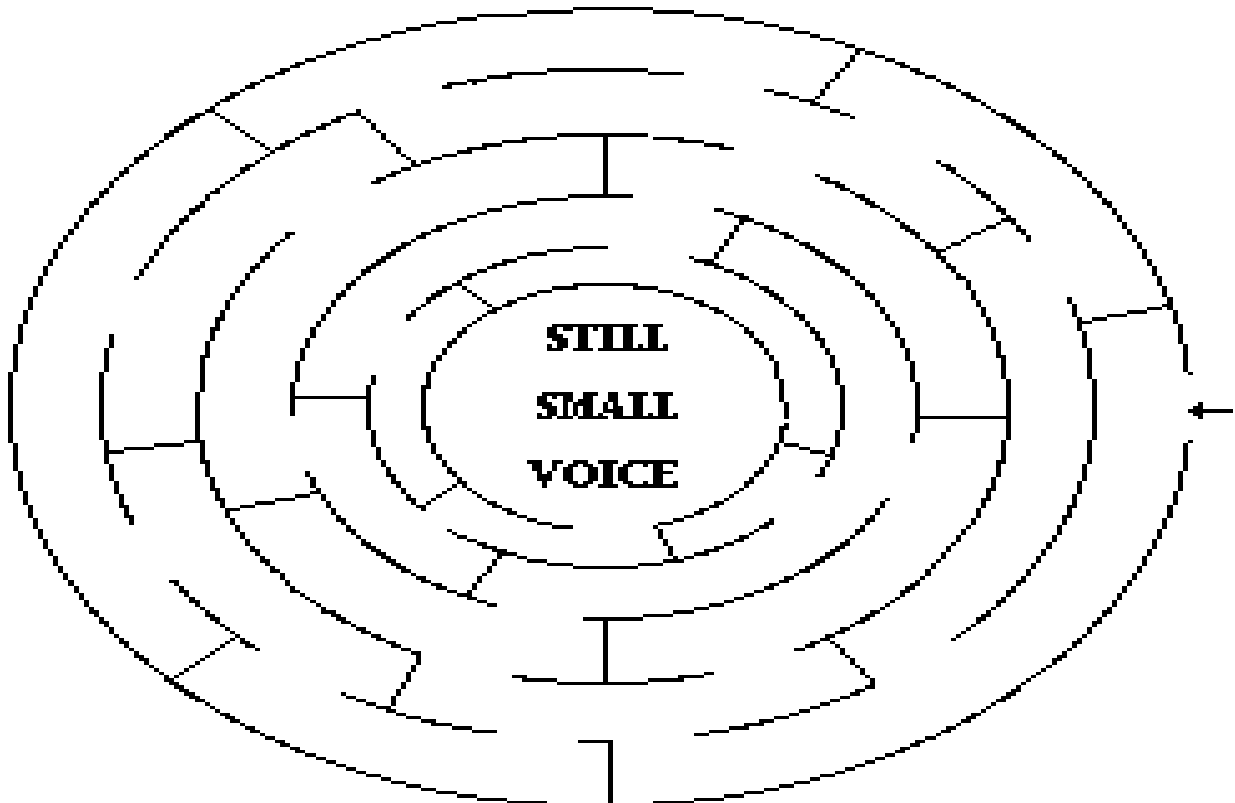

100. THE STILL SMALL VOICE

(1 KINGS 19:11-18)

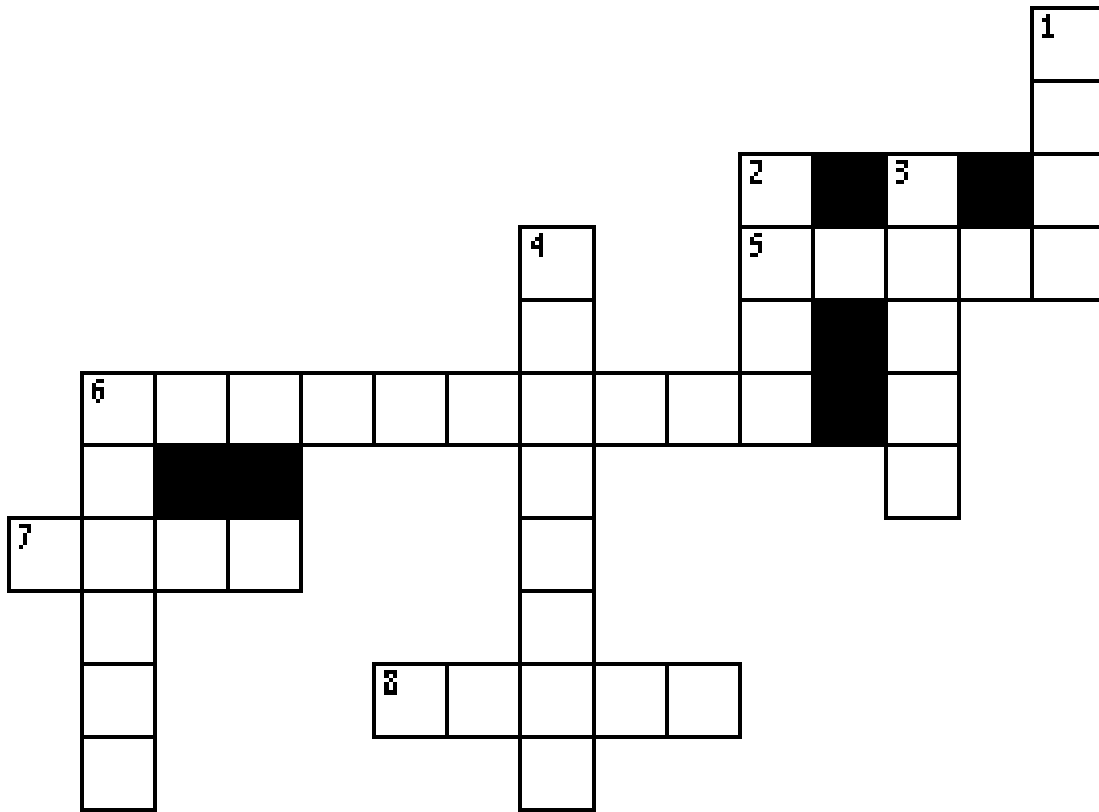

- 4 DOWN The LORD God said to Elijah, "Go out, and stand on the _____ before the LORD." **1 KINGS 19:11**
- 7 ACROSS "Behold, the LORD passed by, and a great and strong _____ tore into the mountains and broke the rocks in pieces before the LORD." **1 KINGS 19:11**
- 6 ACROSS "After the wind an _____." **1 KINGS 19:11**
- 1 DOWN "After the earthquake a _____." **1 KINGS 19:12**
- 8 ACROSS "After the fire a still small _____." **1 KINGS 19:12**
- 2 DOWN "So it was, when Elijah heard it, that he wrapped his face in his mantel and went out and stood in the entrance of the _____." **1 KINGS 19:13**
- 6 DOWN "And suddenly a voice came to him, and said, 'What are you doing here, _____?'" **1 KINGS 19:13**
- 5 ACROSS Elijah said, "I have been very zealous for the LORD God of hosts; because the children of Israel have forsaken your covenant, torn down Your altars, and killed Your prophets with the sword. I _____ am left; and they seek to take my life." **1 KINGS 19:14**
- 3 DOWN The LORD said to Elijah, "I have reserved seven thousand in Israel, all whose knees have not _____ to Baal, and every mouth that has not kissed him." **1 KINGS 19:18**

Bible Story 101

**ELIJAH
CHOOSES ELISHA**

1 KINGS 19:19-21

101. ELIJAH CHOOSES ELISHA

(1 KINGS 19:19-21)



"So he departed thence, and found Elisha the son of Shaphat, who was plowing *with twelve yoke of oxen* before him, and he with the twelfth: and Elijah passed by him, and cast his mantle upon him."

1 KINGS 19:19

101. ELIJAH CHOOSES ELISHA

(1 KINGS 19:19-21)

MEMORY VERSE:

"So he departed from there, and found Elisha the son of Shaphat, who was plowing with twelve yoke of oxen before him." 1 KINGS 19:19

CIRCLE THE CORRECT WORD:

1. Elijah "found Elisha the son of Shaphat, who was (**BOWING, PLOWING**) with twelve yoke of oxen before him, and he was with the twelfth." **1 KINGS 19:19**

TRUE OR FALSE:

2. "Then Elijah passed by him and threw his mantle on him." **1 KINGS 19:19**
TRUE OR FALSE
3. But he would not leave the oxen nor run after Elijah. **1 KINGS 19:20**
TRUE OR FALSE

CIRCLE THE CORRECT WORD:

4. Elisha said to Elijah, "Please let me kiss my father and my mother, and then I will (**FIGHT, FOLLOW**) you." **1 KINGS 19:20**

TRUE OR FALSE:

5. Elijah said, "Go back again, for what have I done to you?" **1 KINGS 19:20**
TRUE OR FALSE

CIRCLE THE CORRECT WORD:

6. After eating with the people, "he arose and followed Elijah, and (**LEFT, SERVED**) him." **1 KINGS 19:21**

101. ELIJAH CHOOSES ELISHA

(1 KINGS 19:19-21)

E	L	I	S	H	A	J	Q	F	K
H	L	G	E	C	W	Q	O	M	N
D	N	H	G	B	O	L	L	E	M
T	Z	A	Q	N	L	X	L	N	G
N	H	J	M	O	I	T	E	O	G
Y	R	I	W	B	N	W	A	N	T
B	A	L	B	A	D	X	O	A	E
P	A	E	M	Y	O	Z	L	L	L
X	J	H	M	U	N	P	L	L	P
U	Y	S	S	E	R	V	E	D	S

ELIJAH
ELISHA
FOLLOW

MANTLE
OXEN

PLOWING
SERVED

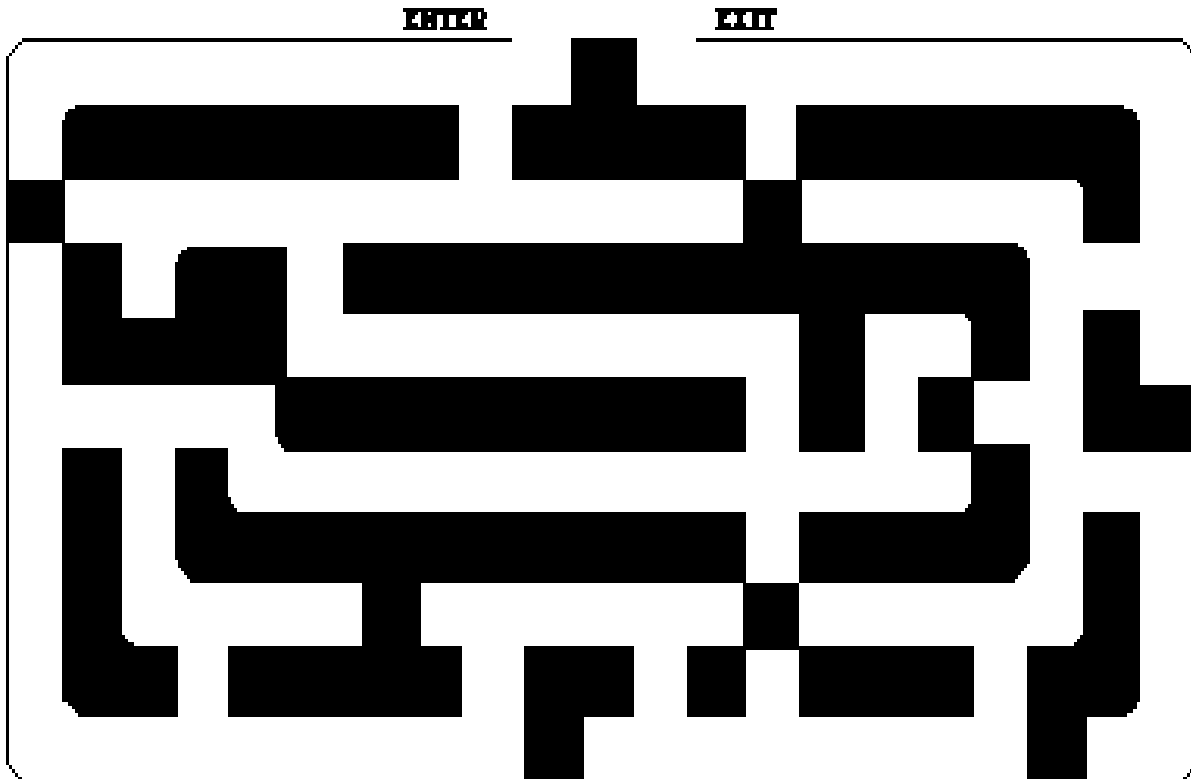

101. ELIJAH CHOOSES ELISHA

(1 KINGS 19:19-21)

MEMORY VERSE:

"So he departed from there, and found Elisha the son of Shaphat, who was plowing with twelve yoke of oxen before him." 1 KINGS 19:19

FILL IN THE BLANK:

1. Elijah "found Elisha the son of Shaphat, who was _____ with twelve yoke of oxen before him, and he was with the twelfth." **1 KINGS 19:19**

TRUE OR FALSE:

2. "Then Elijah passed by him and threw his mantle on him." **1 KINGS 19:19**
TRUE OR FALSE
3. But he would not leave the oxen nor run after Elijah. **1 KINGS 19:20**
TRUE OR FALSE

FILL IN THE BLANK:

4. Elisha said to Elijah, "Please let me kiss my father and my mother, and then I will _____ you." **1 KINGS 19:20**

TRUE OR FALSE:

5. Elijah said, "Go back again, for what have I done to you?" **1 KINGS 19:20**
TRUE OR FALSE

FILL IN THE BLANK:

6. After eating with the people, "he arose and followed Elijah, and _____ him." **1 KINGS 19:21**

101. ELIJAH CHOOSES ELISHA

(1 KINGS 19:19-21)

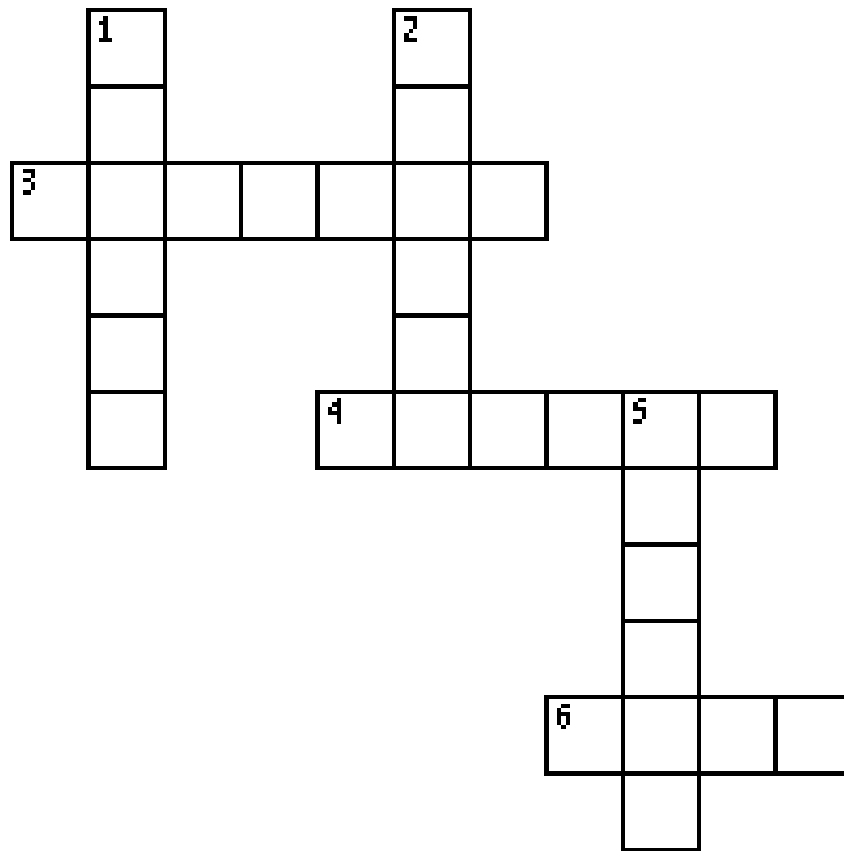

- 3 ACROSS Elijah "found Elisha the son of Shaphat, who was _____ with twelve yoke of oxen before him, and he was with the twelfth." **1 KINGS 19:19**
- 2 DOWN "Then Elijah passed by him and threw his _____ on him." **1 KINGS 19:19**
- 5 DOWN "And he left the oxen and ran after _____." **1 KINGS 19:20**
- 1 DOWN Elisha said to Elijah, "Please let me kiss my father and my mother, and then I will _____ you." **1 KINGS 19:20**
- 6 ACROSS Elijah said, "Go _____ again, for what have I done to you?" **1 KINGS 19:20**
- 4 ACROSS After eating with the people, "he arose and followed Elijah, and _____ him." **1 KINGS 19:21**

Bible Story 102

**ELIJAH IS TAKEN
TO HEAVEN**

2 KINGS 2:1-11

102. ELIJAH IS TAKEN TO HEAVEN

(2 KINGS 2:1-11)

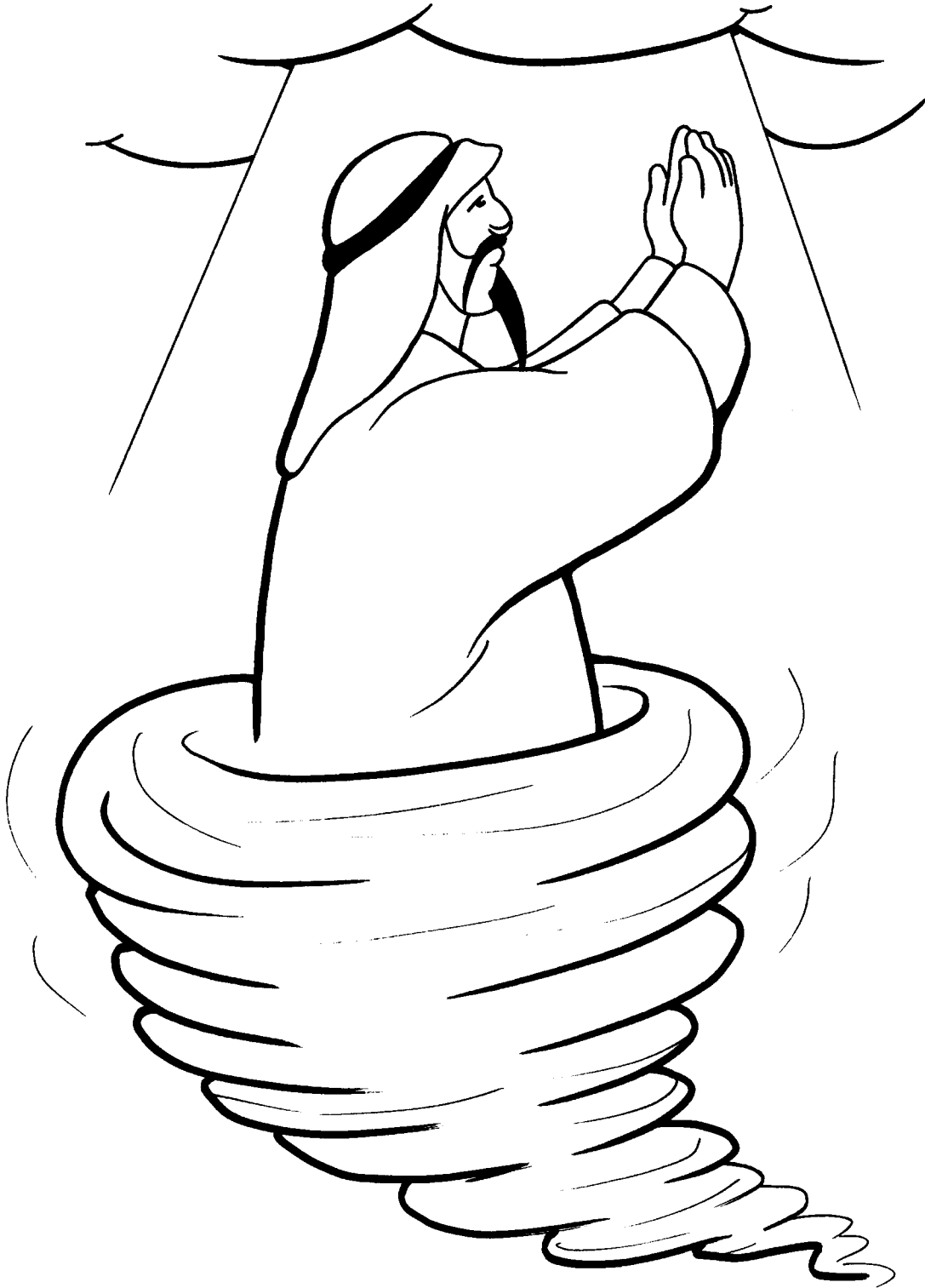

"Suddenly a chariot of fire appeared with horses of fire, and separated the two of them; and Elijah went up by a whirlwind into heaven."

2 KINGS 2:11

102. ELIJAH IS TAKEN TO HEAVEN

(2 KINGS 2:1-11)

MEMORY VERSE:

"Suddenly a chariot of fire appeared with horses of fire, and separated the two of them; and Elijah went up by a whirlwind into heaven." 2 KINGS 2:11

TRUE OR FALSE:

1. "And it came to pass, when the LORD was about to take up Elijah into heaven by a whirlwind, that Elijah went with Elisha from Gilgal." **2 KINGS 2:1**

TRUE OR FALSE

UNDERLINE THE CORRECT ANSWER:

2. "Then Elijah said to Elisha, 'Stay here, please, for the LORD has sent me on to Bethel.' And Elisha said..." **2 KINGS 2:2**
 - a. As the LORD lives, and as your soul lives, I will not leave you!
 - b. I will stay!
3. "And the sons of the prophets who were at Bethel came out to Elisha, and said to him..." **2 KINGS 2:3**
 - a. Do you know that the LORD will take away your master from over you today?
 - b. What are you doing here?
4. "Then Elijah said to him, 'Elisha, stay here, please, for the LORD has sent me on to Jericho.' And he said..." **2 KINGS 2:4**
 - a. As the LORD lives, and as your soul lives, I will not leave you!
 - b. I will stay!
5. "And the sons of the prophets who were at Jericho came to Elisha, and said to him..." **2 KINGS 2:5**
 - a. Do you know that the LORD will take away your master from over you today?
 - b. What are you doing here?
6. "Then Elijah said to him, 'Stay here, please, for the LORD has sent me on to the Jordan.' And he said..." **2 KINGS 2:6**
 - a. As the LORD lives, and as your soul lives, I will not leave you!
 - b. I will stay!

CIRCLE THE CORRECT WORDS:

7. "And fifty men of the sons of the prophets went and stood facing them at a distance, while the two of them stood by the (**MOUNTAIN, JORDAN**)." **2 KINGS 2:7**
8. "Now Elijah took his mantle, rolled it up, and struck the water; and it was divided this way and that, so that the two of them crossed over on (**HIGH, DRY**) ground." **2 KINGS 2:8**
9. "And so it was, when they had crossed over, that Elijah said to Elisha, 'Ask! What may I do for you, before I am taken away from you? And Elisha said, 'Please let a (**DOUBLE, TROUBLE**) portion of your spirit be upon me.' " **2 KINGS 2:9**
10. "So he said, 'You have asked a (**EASY, HARD**) thing. Nevertheless, if you see me when I am taken from you, it shall be so for you; but if not, it shall not be so.' " **2 KINGS 2:10**
11. "Suddenly a chariot of fire appeared with horses of fire, and separated the two of them; and Elijah went up by a (**LADDER, WHIRLWIND**) into heaven." **2 KINGS 2:11**

102. ELIJAH IS TAKEN TO HEAVEN

(2 KINGS 2:1-11)

J M A N T L E M O J Z N G L G
E P W K C Q A A J H A P R L K
R E Z E T D Y Z J D W Y G L B
I S K F I J Y S R G B E N E U
C G S T E H P O R P M L G H K
H D K J O Q J H E E W I Z T C
O E Q T T R O M A U U S J E U
M P J E A I F P W W F H P B M
G E R I F F O T O I R A H C D
F Z B J N L V X L R I B E M L
H C E L B U O D Z D T L N S S
A C B Z R S M S P W I I U Z V
W H I R L W I N D J X D O F R
W Q R Z P T S V A Y G R O N C
X I B K I F V H P P Y C F P M

BETHEL

ELISHA

PORTION

CHARIOT OF FIRE

JERICHO

PROPHETS

DOUBLE

JORDAN

WHIRLWIND

ELIJAH

MANTLE

102. ELIJAH IS TAKEN TO HEAVEN

(2 KINGS 2:1-11)

MEMORY VERSE:

"Suddenly a chariot of fire appeared with horses of fire, and separated the two of them; and Elijah went up by a whirlwind into heaven." 2 KINGS 2:11

TRUE OR FALSE:

1. "And it came to pass, when the LORD was about to take up Elijah into heaven by a whirlwind, that Elijah went with Elisha from Gilgal." **2 KINGS 2:1**

TRUE OR FALSE

UNDERLINE THE CORRECT ANSWER:

2. "Then Elijah said to Elisha, 'Stay here, please, for the LORD has sent me on to Bethel.' And Elisha said..." **2 KINGS 2:2**
a. As the LORD lives, and as your soul lives, I will not leave you!
b. I will stay!
3. "And the sons of the prophets who were at Bethel came out to Elisha, and said to him..." **2 KINGS 2:3**
a. Do you know that the LORD will take away your master from over you today?
b. What are you doing here?
4. "Then Elijah said to him, 'Elisha, stay here, please, for the LORD has sent me on to Jericho.' And he said..." **2 KINGS 2:4**
a. As the LORD lives, and as your soul lives, I will not leave you!
b. I will stay!
5. "And the sons of the prophets who were at Jericho came to Elisha, and said to him..." **2 KINGS 2:5**
a. Do you know that the LORD will take away your master from over you today?
b. What are you doing here?
6. "Then Elijah said to him, 'Stay here, please, for the LORD has sent me on to the Jordan.' And he said..." **2 KINGS 2:6**
a. As the LORD lives, and as your soul lives, I will not leave you!
b. I will stay!

FILL IN THE BLANKS:

7. "And fifty men of the sons of the prophets went and stood facing them at a distance, while the two of them stood by the _____." **2 KINGS 2:7**
8. "Now Elijah took his mantle, rolled it up, and struck the water; and it was divided this way and that, so that the two of them crossed over on _____ ground." **2 KINGS 2:8**
9. "And so it was, when they had crossed over, that Elijah said to Elisha, 'Ask! What may I do for you, before I am taken away from you? And Elisha said, 'Please let a _____ portion of your spirit be upon me.' " **2 KINGS 2:9**
10. "So he said, 'You have asked a _____ thing. Nevertheless, if you see me when I am taken from you, it shall be so for you; but if not, it shall not be so.' " **2 KINGS 2:10**
11. "Suddenly a chariot of fire appeared with horses of fire, and separated the two of them; and Elijah went up by a _____ into heaven." **2 KINGS 2:11**

102. ELIJAH IS TAKEN TO HEAVEN

(2 KINGS 2:1-11)

I X G P M R Z S Y Q S S E A M K P D W L
O Y F W E Y C C J O R D A N X Y L I J J
X L Z C Z G L N M L T Y U I U H O M H T
K N A P I N W P B P V X V P V F P O N B
E D N R I W C N O I T R O P E L B U O D
Y L E H T E B M A N T L E Q E Q D O F V
T C S F D E A C P V G F E F Z X Q F G Q
E V H D Z Y R X R G W L F R U H J U I O
Z O U N N Z Z I Y Y I L P R O P H E T S
Q S S I Z R S C F S D K I C U M J D E V
V K Y W V G D X H F K I U G I G T I G Y
L L J L U F G A R Q O Q H O X Q I V W X
S D N R D H P O E D A T I W Q W R E K C
R F D I W Y A P H O G S O J B G I M O J
S A Y H E I C J X C S S P I V X P N I N
B B I W E F V R I O I O K V R W S B L B
B R B M B B U E V L A R R H B A C A D L
Z N L E D L I M T K E E E Y W D H S S L
F E O T V A P H O P U Z E J Y I M C R D
W W U L N E N Y J Z K P N G U C V P J N

BETHEL

ELISHA

PORTION

CHARIOT OF FIRE

JERICO

PROPHETS

DOUBLE

JORDAN

WHIRLWIND

ELIJAH

MANTLE

102. ELIJAH IS TAKEN TO HEAVEN

(2 KINGS 2:1-11)

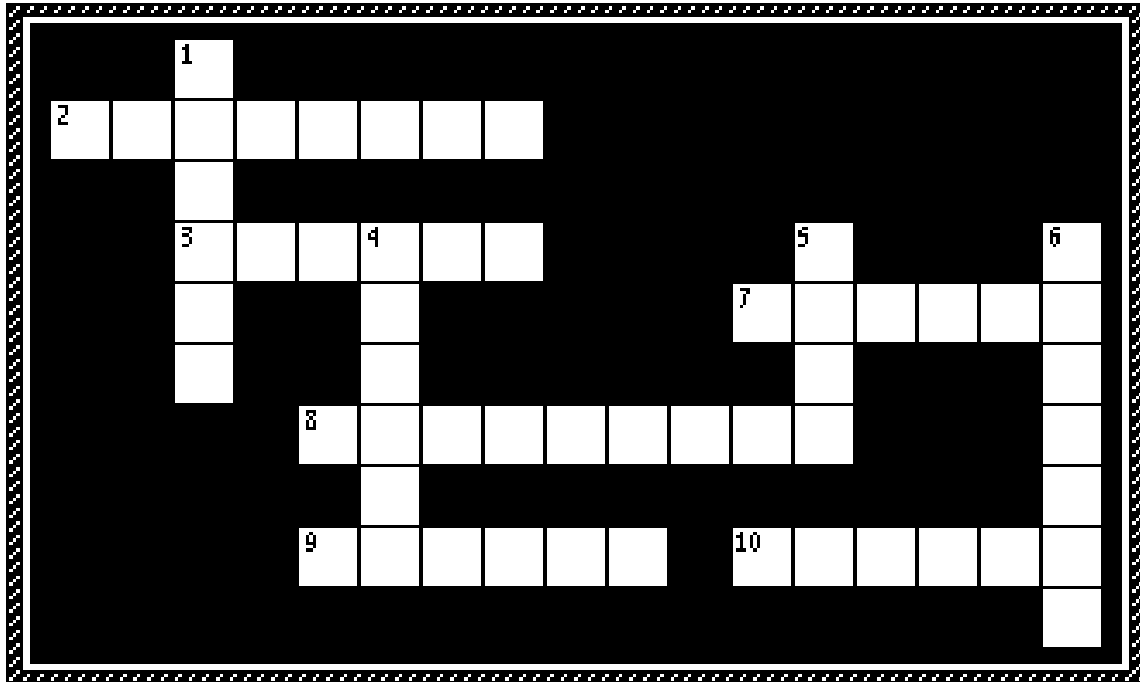

- 9 ACROSS "And it came to pass, when the LORD was about to take up Elijah into heaven by a whirlwind, that Elijah went with _____ from Gilgal." **2 KINGS 2:1**
- 4 DOWN "Then Elijah said to Elisha, 'Stay here, please, for the LORD has sent me on to _____.' And Elisha said, 'As the LORD lives, and as your soul lives, I will not leave you!' " **2 KINGS 2:2**
- 2 ACROSS "And the sons of the _____ who were at Bethel came out to Elisha, and said to him, 'Do you know that the LORD will take away your master from over you today?' " **2 KINGS 2:3**
- 6 ACROSS "Then Elijah said to him, 'Elisha, stay here, please, for the LORD has sent me on to _____.'" **2 KINGS 2:4**
- 10 ACROSS "Then _____ said to him, 'Stay here, please, for the LORD has sent me on to the Jordan.'" **2 KINGS 2:6**
- 1 DOWN "And fifty men of the sons of the prophets went and stood facing them at a distance, while the two of them stood by the _____." **2 KINGS 2:7**
- 7 ACROSS "Now Elijah took his _____, rolled it up, and struck the water; and it was divided this way and that, so that the two of them crossed over on dry ground." **2 KINGS 2:8**
- 3 ACROSS "And so it was, when they had crossed over, that Elijah said to Elisha, 'Ask! What may I do for you, before I am taken away from you? And Elisha said, 'Please let a _____ portion of your spirit be upon me.' " **2 KINGS 2:9**
- 5 DOWN "So he said, 'You have asked a _____ thing. Nevertheless, if you see me when I am taken from you, it shall be so for you; but if not, it shall not be so.' " **2 KINGS 2:10**
- 8 ACROSS "Suddenly a chariot of fire appeared with horses of fire, and separated the two of them; and Elijah went up by a _____ into heaven." **2 KINGS 2:11**

Bible Story 103

**ELISHA CROSSES
THE RIVER**

2 KINGS 2:13-15

103. ELISHA CROSSES THE RIVER

(2 KINGS 2:13-15)



"And he took the mantle of Elijah that fell from him, and smote the waters, and said, Where *is* the LORD God of Elijah? and when he also had smitten the waters, they parted hither and thither: and Elisha went over."

2 KINGS 2:14

103. ELISHA CROSSES THE RIVER

(2 KINGS 2:13-15)

MEMORY VERSE:

"Now when the sons of the prophets who were from Jericho saw him, they said, 'The spirit of Elijah rests on Elisha.' " 2 KINGS 2:15

CIRCLE THE CORRECT WORD:

1. Elisha "took the (MANTLE, SHOE) of Elijah that had fallen from him, and struck the water." 2 KINGS 2:13

TRUE OR FALSE:

2. He "went back and stood by the bank of the Jordan." 2 KINGS 2:13
TRUE OR FALSE

CIRCLE THE CORRECT WORD:

3. "Then he took the mantle of Elijah that had fallen from him, and struck the (BUSHES, WATER)." 2 KINGS 2:14

TRUE OR FALSE:

4. He said, "Where is the LORD God of Elijah?" 2 KINGS 2:14
TRUE OR FALSE

5. When he struck the water, nothing happened. 2 KINGS 2:14
TRUE OR FALSE

6. "Elisha crossed over." 2 KINGS 2:14
TRUE OR FALSE

CIRCLE THE CORRECT WORDS:

7. "Now when the sons of the prophets who were from Jericho saw him, they said, 'The (SPIRIT, MANTLE) of Elijah rests on Elisha.' " 2 KINGS 2:15

8. "They came to meet him, and (PLOWED, BOWED) to the ground before him." 2 KINGS 2:15

103. ELISHA CROSSES THE RIVER

(2 KINGS 2:13-15)

O S T E H P O R P Q
M A N T L E S Y L D
M D E W O B P J C I
E E L D I V I D E D
L S J V Z N R W Q D
I S O E M E I A Y B
S O R H J P T T V V
H R D C A L U E F W
A C A D O G D R O L
F O N K P U H A D Z

BOWED

JORDAN

PROPHETS

CROSSED

LORD GOD

SPIRIT

DIVIDED

MANTLE

WATER

ELISHA

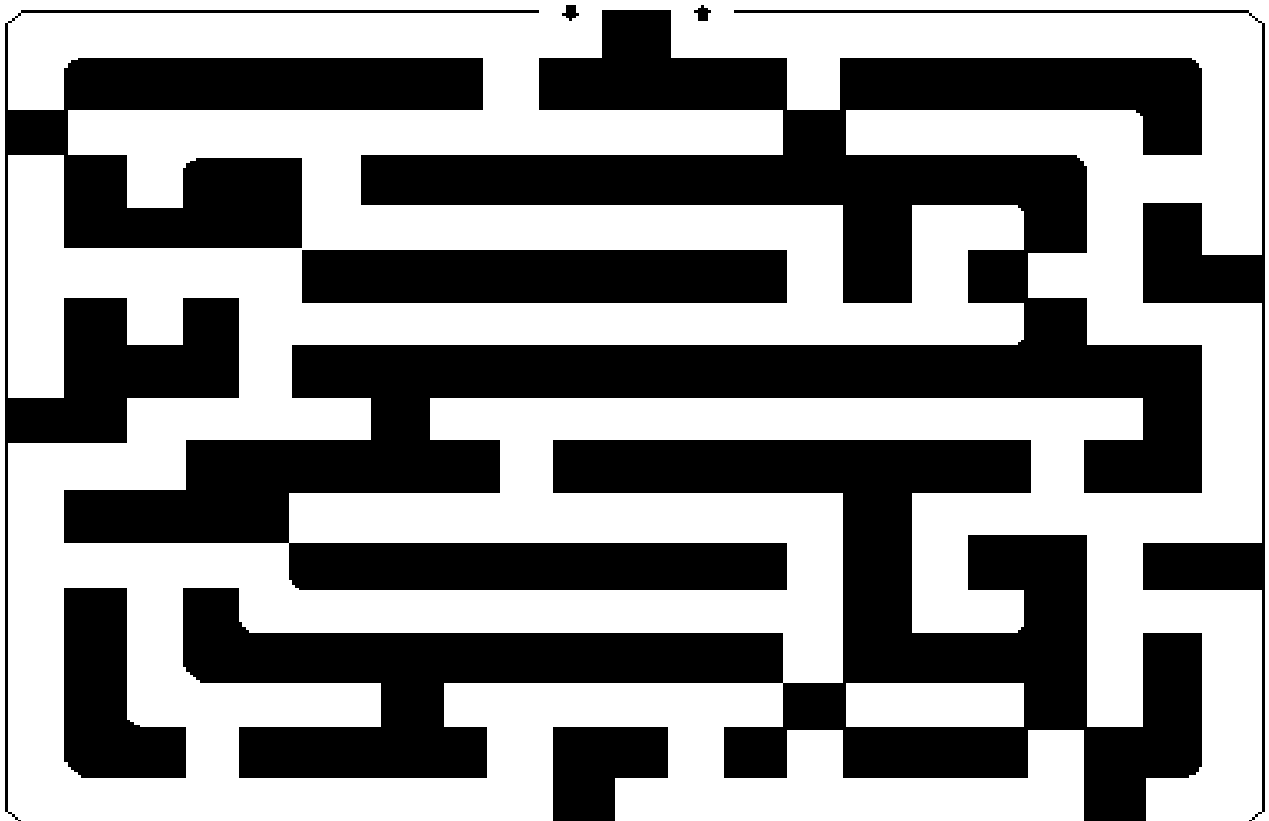

103. ELISHA CROSSES THE RIVER

(2 KINGS 2:13-15)

MEMORY VERSE:

"Now when the sons of the prophets who were from Jericho saw him, they said, 'The spirit of Elijah rests on Elisha.' " 2 KINGS 2:15

FILL IN THE BLANK:

1. Elisha "took the _____ of Elijah that had fallen from him, and struck the water." 2 KINGS 2:13

TRUE OR FALSE:

2. He "went back and stood by the bank of the Jordan." 2 KINGS 2:13
TRUE OR FALSE

FILL IN THE BLANK:

3. "Then he took the mantle of Elijah that had fallen from him, and struck the _____." 2 KINGS 2:14

TRUE OR FALSE:

4. He said, "Where is the LORD God of Elijah?" 2 KINGS 2:14
TRUE OR FALSE
5. When he struck the water, nothing happened. 2 KINGS 2:14
TRUE OR FALSE
6. "Elisha crossed over." 2 KINGS 2:14
TRUE OR FALSE

FILL IN THE BLANKS:

7. "Now when the sons of the prophets who were from Jericho saw him, they said, 'The _____ of Elijah rests on Elisha.' " 2 KINGS 2:15
8. "They came to meet him, and _____ to the ground before him." 2 KINGS 2:15

103. ELISHA CROSSES THE RIVER

(2 KINGS 2:13-15)

E K Q Q V R X O A Q C P A Z U
 L P H S N E L O R D G O D Z A
 M R V P L A W W V S J U Z N F
 G U E I R X D H C Q D E W O B
 M Y S T N O E R A V W T E K F
 B H V P A O P Q O P Y D M O T
 A F G M G W L H L J J E D B Q
 P K S B D S V I E B L D W H H
 M S N B C L D L O T T I Q F A
 W T P O P R D H N Q S V X V U
 N G B I K K O A Z J N I I I U
 G E K H R W M S M I A D T O T
 K Y K S S I Z T S C S N A N T
 B G O S P V T Y F E L D L H D
 Y M J R P J Z O M T D R B I D

BOWED
 CROSSED
 DIVIDED
 ELISHA

JORDAN
 LORD GOD
 MANTLE

PROPHETS
 SPIRIT
 WATER

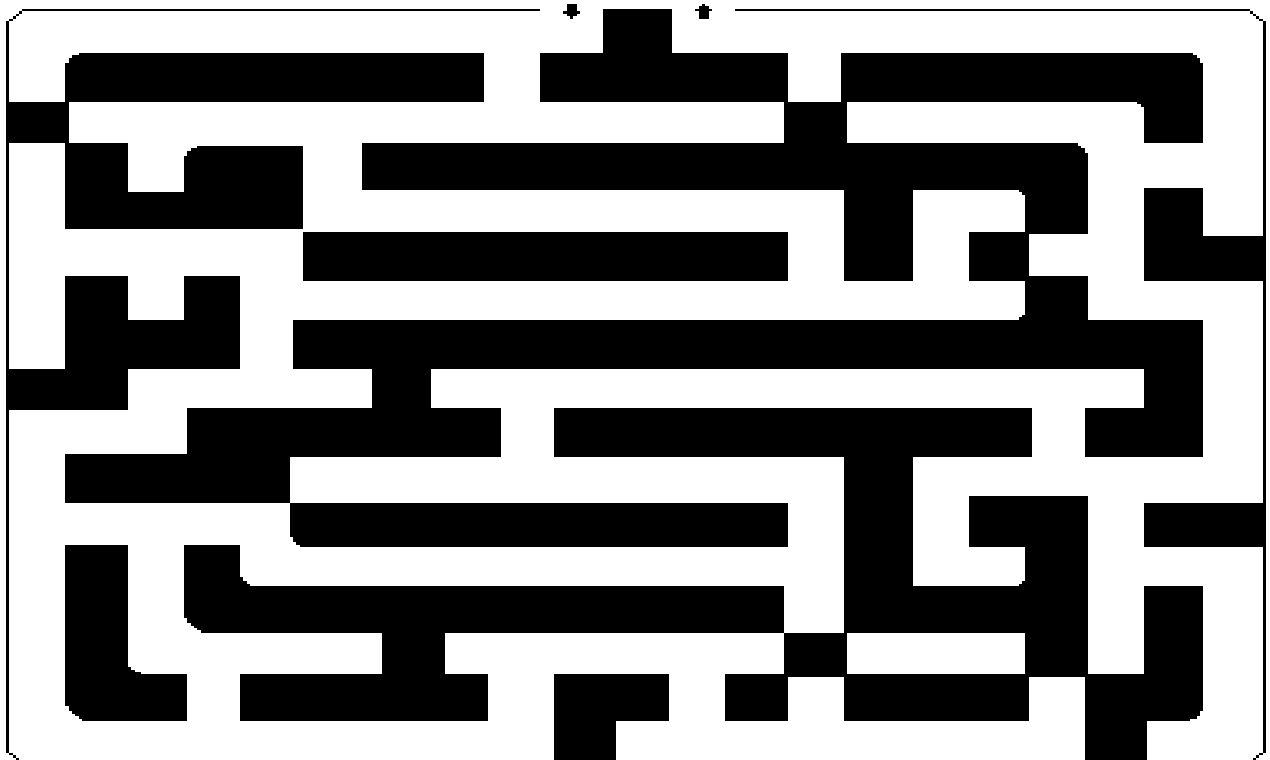

103. ELISHA CROSSES THE RIVER

(2 KINGS 2:13-15)

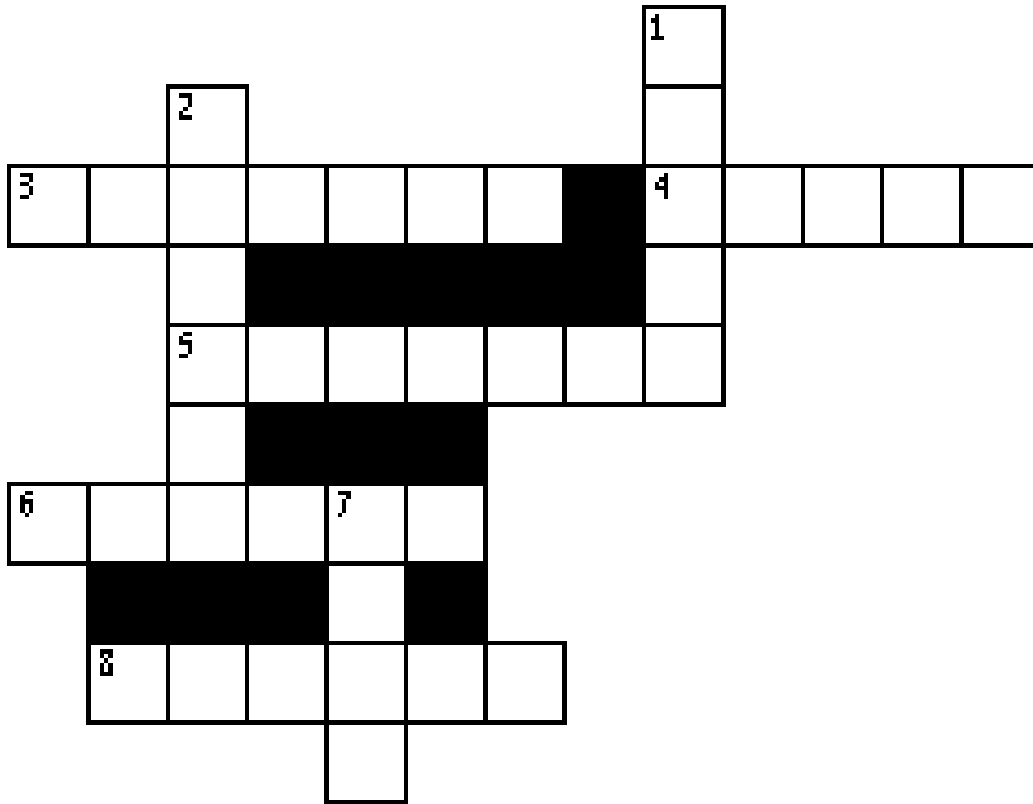

- 6 ACROSS Elisha "took the _____ of Elijah that had fallen from him, and struck the water." **2 KINGS 2:13**
- 2 DOWN He "went back and stood by the bank of the _____." **2 KINGS 2:13**
- 4 ACROSS "Then he took the mantle of Elijah that had fallen from him, and struck the _____." **2 KINGS 2:14**
- 7 DOWN He said, "Where is the _____ God of Elijah?" **2 KINGS 2:14**
- 5 ACROSS "When he also struck the water, it was _____ this way and that." **2 KINGS 2:14**
- 3 ACROSS "Elisha _____ over." **2 KINGS 2:14**
- 8 ACROSS "Now when the sons of the prophets who were from Jericho saw him, they said, 'The _____ of Elijah rests on Elisha.'" **2 KINGS 2:15**
- 1 DOWN "They came to meet him, and _____ to the ground before him." **2 KINGS 2:15**

Bible Story 104

**ELISHA HELPS A
POOR WIDOW**

2 KINGS 4:1-7

104. ELISHA HELPS A POOR WIDOW (2 KINGS 4:1-7)



"So she went from him, and shut the door upon her and upon her sons, who brought *the vessel* to her; and she poured out."

2 KINGS 4:5

104. ELISHA HELPS A POOR WIDOW

(2 KINGS 4:1-7)

MEMORY VERSE:

"Go, sell the oil and pay your debt; and you and your sons live on the rest." 2 KINGS 4:7

TRUE OR FALSE:

1. "A certain woman of the wives of the sons of the prophets cried out to Elisha, saying, 'Your servant my husband is dead, and you know that your servant feared the LORD. And the creditor is coming to take my two sons to be his slaves.'" **2 KINGS 4:1**

TRUE OR FALSE

CIRCLE THE CORRECT WORDS:

2. "So Elisha said to her, 'What shall I do for you? Tell me, what do you have in the house?' And she said, 'Your maidservant has nothing in the house but a jar of (**MONEY, OIL**).'" **2 KINGS 4:2**
3. "Then he said, 'Go, borrow vessels from everywhere, from all your neighbors-(**EMPTY, FULL**) vessels; do not gather just a few.'" **2 KINGS 4:3**

TRUE OR FALSE:

4. "And when you have come in, you shall shut the door behind you and your sons; then pour it into all those vessels, and set aside the full ones." **2 KINGS 4:4**
- TRUE OR FALSE**
5. But she would not do those things which Elisha had told her to do. **2 KINGS 4:5**
- TRUE OR FALSE**

CIRCLE THE CORRECT WORDS:

6. "Now it came to pass, when the vessels were full, that she said to her son, 'Bring me another vessel.' And he said to her, 'There is not another.' So the oil (**INCREASED, CEASED**)."
- 2 KINGS 4:6**
7. "Then she came and told the man of God. And he said, 'Go, (**BUY, SELL**) the oil and pay your debt; and you and your sons live on the rest.'" **2 KINGS 4:7**

104. ELISHA HELPS A POOR WIDOW

(2 KINGS 4:1-7)

B E V U Y W S Z O C
T Q G S A V L J B B
I G L N O H E Y A R
T A S Y Z N S I D R
L S J L M V S I R N
K D E T A N E W L V
W B C L M V V Z F E
Q D L F L C E L U N
I I W O M A N S L O
O L T U H K N M L L

ELISHA
FULL
JAR

OIL
SELL
SLAVES

SONS
VESSELS
WOMAN

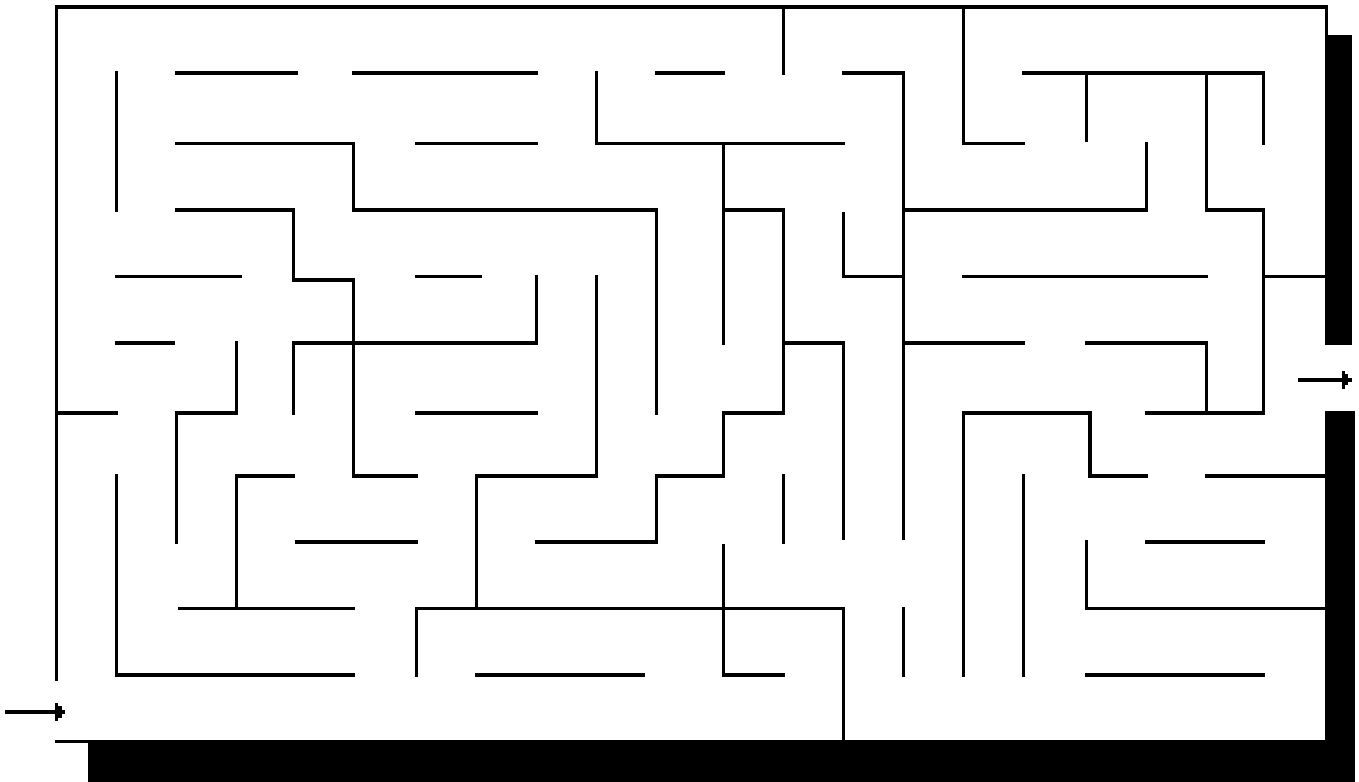

104. ELISHA HELPS A POOR WIDOW

(2 KINGS 4:1-7)

MEMORY VERSE:

"Go, sell the oil and pay your debt; and you and your sons live on the rest." 2 KINGS 4:7

TRUE OR FALSE:

1. "A certain woman of the wives of the sons of the prophets cried out to Elisha, saying, 'Your servant my husband is dead, and you know that your servant feared the LORD. And the creditor is coming to take my two sons to be his slaves.' " 2 KINGS 4:1

TRUE OR FALSE

CIRCLE THE CORRECT WORDS:

2. "So Elisha said to her, 'What shall I do for you? Tell me, what do you have in the house?' And she said, 'Your maidservant has nothing in the house but a jar of _____.' " 2 KINGS 4:2
3. "Then he said, 'Go, borrow vessels from everywhere, from all your neighbors-_____ vessels; do not gather just a few.' " 2 KINGS 4:3

TRUE OR FALSE:

4. "And when you have come in, you shall shut the door behind you and your sons; then pour it into all those vessels, and set aside the full ones." 2 KINGS 4:4
- TRUE OR FALSE**
5. But she would not do those things which Elisha had told her to do. 2 KINGS 4:5
- TRUE OR FALSE**

CIRCLE THE CORRECT WORDS:

6. "Now it came to pass, when the vessels were full, that she said to her son, 'Bring me another vessel.' And he said to her, 'There is not another.' So the oil _____." 2 KINGS 4:6
7. "Then she came and told the man of God. And he said, 'Go, _____ the oil and pay your debt; and you and your sons live on the rest.' " 2 KINGS 4:7

104. ELISHA HELPS A POOR WIDOW (2 KINGS 4:1-7)

F A T K R B X N S S R A T T E
T D F N F Z W H Z L O F J O C
N B U Z N U P E G E Z J G L U
B D Y Y B Z L A I S G A A S C
T L I V E V K L K S E H A R J
I L Z E R X Y T W E C D Z T T
T V S I L O N E B V J W T R H
L G M O N I B N N U X Y U X H
K L M W N A S H A S P F J Z L
W J H Z V S J H E M D Z Q U Z
Q C W L N E J V A M O W K O R
I T V M O L A D K J J W K I L
E U V O L L G I C B P G V L P
Q N N B S O J L H O D Z H O J
G Y C D O H V Q P J Q T S W Z

ELISHA
FULL
JAR

OIL
SELL
SLAVES

SONS
VESSELS
WOMAN

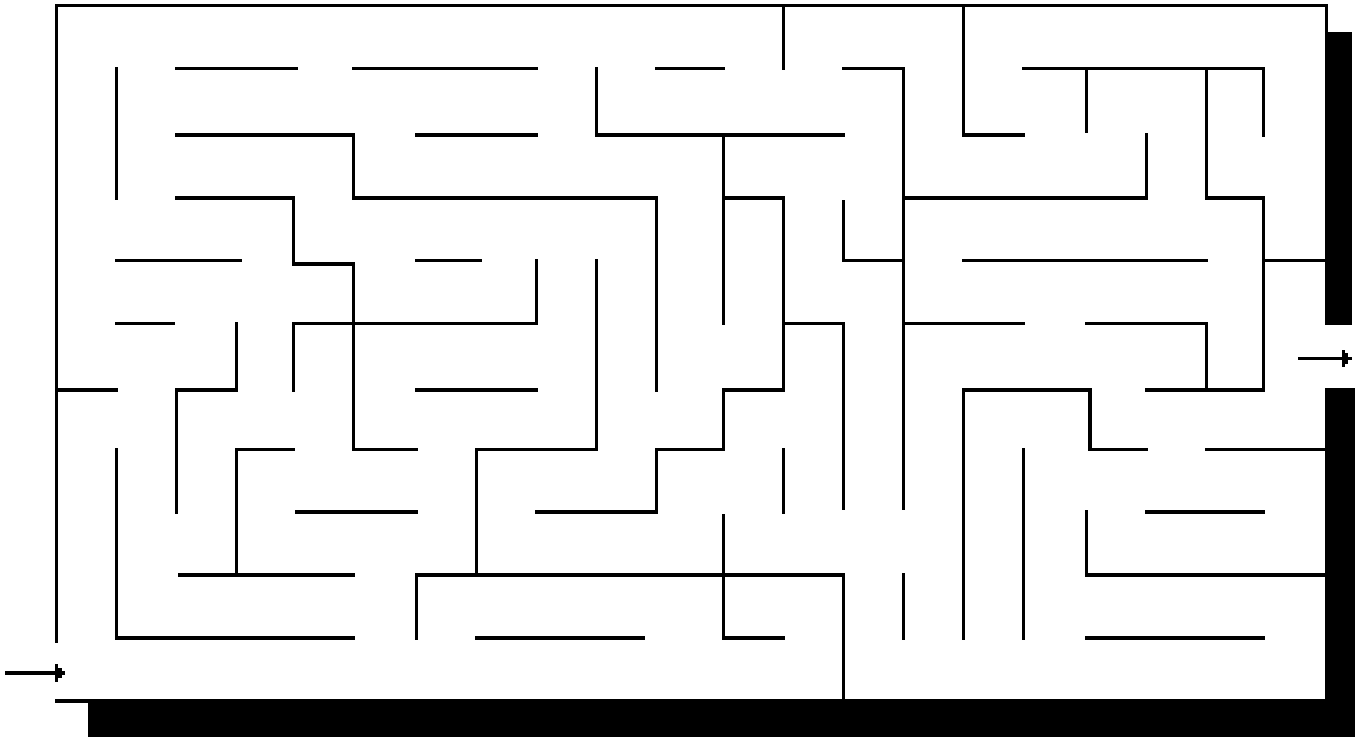

104. ELISHA HELPS A POOR WIDOW

(2 KINGS 4:1-7)

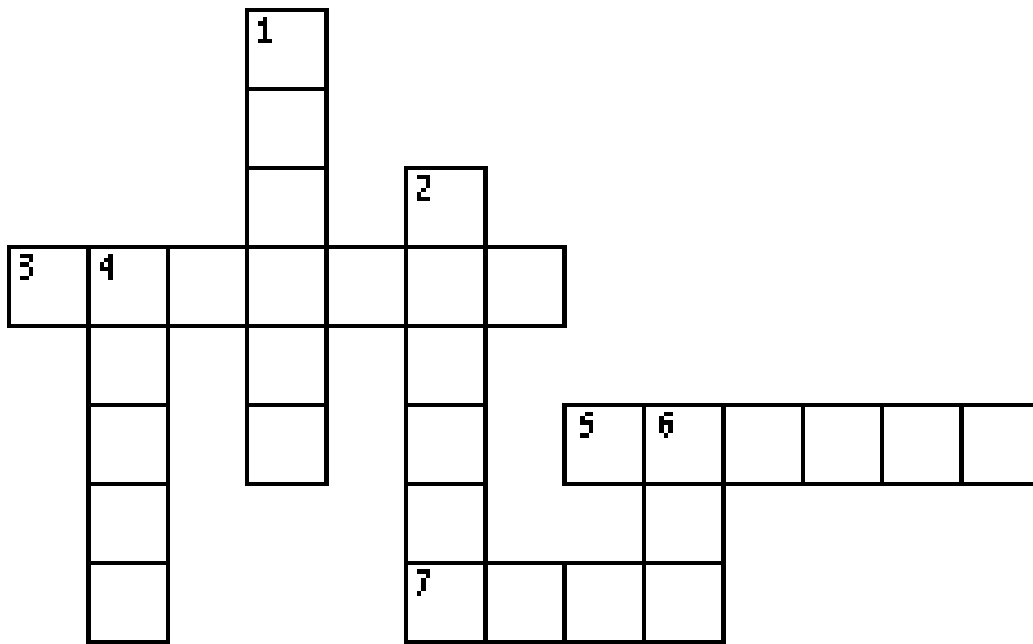

- 2 DOWN "A certain woman of the wives of the sons of the prophets cried out to Elisha, saying, 'Your servant my husband is dead, and you know that your servant feared the LORD. And the creditor is coming to take my two sons to be his ____.'" **2 KINGS 4:1**
- 6 DOWN "So Elisha said to her, 'What shall I do for you? Tell me, what do you have in the house?' And she said, 'Your maidservant has nothing in the house but a jar of ____.'" **2 KINGS 4:2**
- 4 DOWN "Then he said, 'Go, borrow vessels from everywhere, from all your neighbors- ____ vessels; do not gather just a few.'" **2 KINGS 4:3**
- 3 ACROSS "And when you have come in, you shall shut the door behind you and your sons; then pour it into all those ____, and set aside the full ones." **2 KINGS 4:4**
- 5 ACROSS "So she went from him and shut the door behind her and her sons, who brought the vessels to her; and she ____ it out." **2 KINGS 4:5**
- 1 DOWN "Now it came to pass, when the vessels were full, that she said to her son, 'Bring me another vessel.' And he said to her, 'There is not another.' So the oil ____." **2 KINGS 4:6**
- 7 ACROSS "Then she came and told the man of God. And he said, 'Go, ____ the oil and pay your debt; and you and your sons live on the rest.'" **2 KINGS 4:7**

Bible Story 105

**ELISHA AND THE
SHUNAMMITE WOMAN**

2 KINGS 4:8-17

105. ELISHA AND THE SHUNAMMITE WOMAN (2 KINGS 4:8-17)



"And he said, About this season, according to the time of life, thou shalt embrace a son. And she said, Nay, my lord, *thou* man of God, do not lie unto thine handmaid. And the woman conceived, and bare a son at that season that Elisha had said unto her, according to the time of life."

2 KINGS 4:16-17

105. ELISHA AND THE SHUNAMMITE WOMAN

(2 KINGS 4:8-17)

MEMORY VERSE:

"And she said to her husband, 'Look now, I know that this is a holy man of God, who passes by us regularly.' " 2 KINGS 4:9

TRUE OR FALSE:

1. "Now it happened one day that Elisha went to Shunem, where there was a notable woman, and she constrained him to eat some food. So it was, as often as he passed by, that he turned in there to eat some food." 2 KINGS 4:8

TRUE OR FALSE

2. "And she said to her husband, 'Look now, I know that this is a holy man of God, who passes by us regularly.' " 2 KINGS 4:9

TRUE OR FALSE

CIRCLE THE CORRECT WORDS:

3. She said, "Please, let us make a small upper (**BROOM, ROOM**) on the wall; and let us put a bed for him there, and a table and a chair and a lampstand; so it will be, whenever he comes to us, he can turn in there." 2 KINGS 4:10
4. Elijah said to Gehazi his servant, 'Call this Shunammite woman.' When he called her, she stood before him. And he said to him, 'Say now to her, "Look, you have been concerned for us with all this (**CARE, HAIR**). What can I do for you?" ' " 2 KINGS 4:12-13

TRUE OR FALSE:

5. "Gehazi answered, 'Actually, she has no son, and her husband is old.' " 2 KINGS 4:14

TRUE OR FALSE

CIRCLE THE CORRECT WORD:

6. "Then he said, 'About this time next year you shall embrace a (**SON, DAUGHTER**).' And she said, 'No, my lord. Man of God, do not lie to your maidservant!' " 2 KINGS 4:16

TRUE OR FALSE:

7. And the woman did not conceive, and bore no son when the appointed time had come, of which Elisha had told her. 2 KINGS 4:17

TRUE OR FALSE

105. ELISHA AND THE SHUNAMMITE WOMAN

(2 KINGS 4:8-17)

E L I S H A H E M H
G E V R Q O Y E U Q
E N F E F W N S M B
H O I N R U B Z A V
A T U A H A G U N B
Z A H S N J M U O W
I B I D D C M I F R
E L P I A O P N G O
Z E K R C V O M O O
P U E P G S V F D M

CARE
ELISHA
FOOD
GEHAZI

HUSBAND
MAN OF GOD
NOTABLE

ROOM
SHUNEM
SON

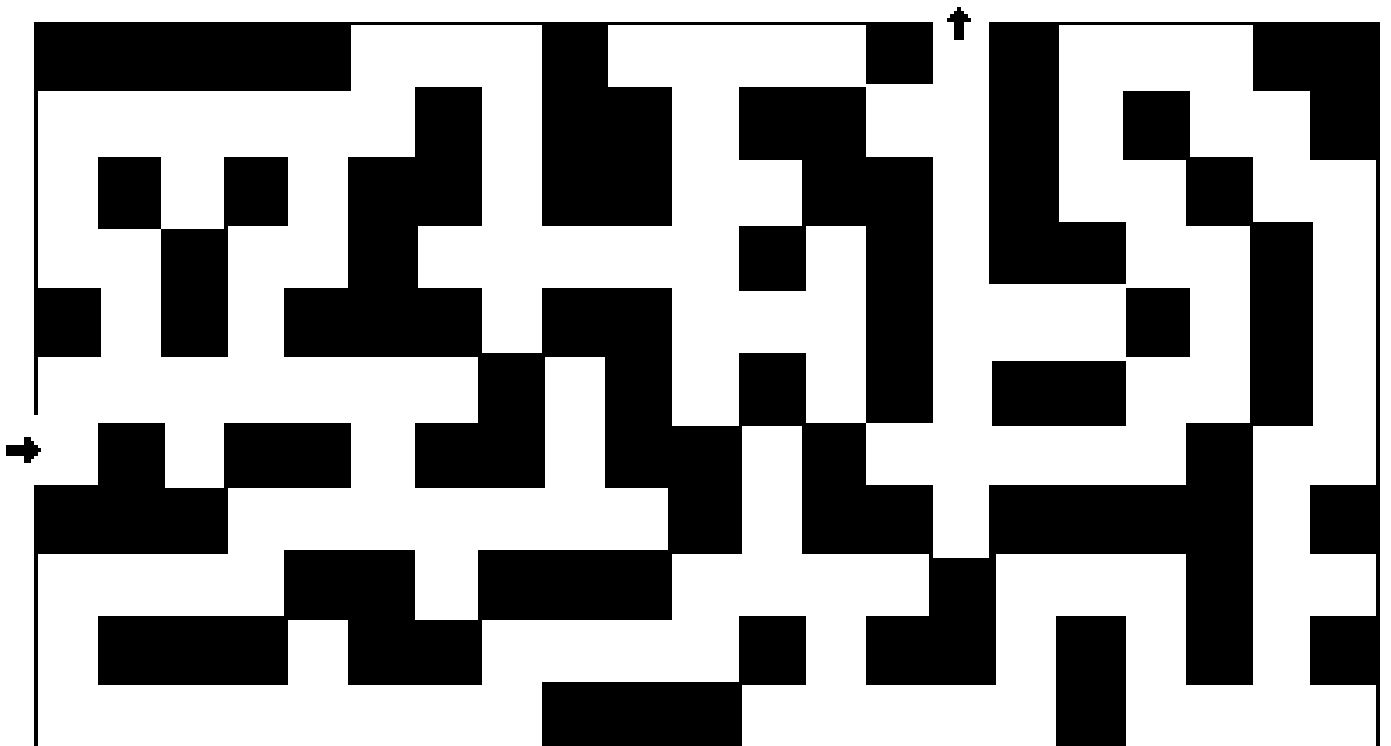

105. ELISHA AND THE SHUNAMMITE WOMAN

(2 KINGS 4:8-17)

MEMORY VERSE:

"And she said to her husband, 'Look now, I know that this is a holy man of God, who passes by us regularly.' " 2 KINGS 4:9

TRUE OR FALSE:

1. "Now it happened one day that Elisha went to Shunem, where there was a notable woman, and she constrained him to eat some food. So it was, as often as he passed by, that he turned in there to eat some food." 2 KINGS 4:8

TRUE OR FALSE

2. "And she said to her husband, 'Look now, I know that this is a holy man of God, who passes by us regularly.' " 2 KINGS 4:9

TRUE OR FALSE

FILL IN THE BLANKS:

3. She said, "Please, let us make a small upper _____ on the wall; and let us put a bed for him there, and a table and a chair and a lampstand; so it will be, whenever he comes to us, he can turn in there." 2 KINGS 4:10
4. Elijah said to Gehazi his servant, 'Call this Shunammite woman.' When he called her, she stood before him. And he said to him, 'Say now to her, "Look, you have been concerned for us with all this _____. What can I do for you?" ' " 2 KINGS 4:12-13

TRUE OR FALSE:

5. "Gehazi answered, 'Actually, she has no son, and her husband is old.' " 2 KINGS 4:14

TRUE OR FALSE

FILL IN THE BLANK:

6. "Then he said, 'About this time next year you shall embrace a _____.' And she said, 'No, my lord. Man of God, do not lie to your maidservant!' " 2 KINGS 4:16

TRUE OR FALSE:

7. And the woman did not conceive, and bore no son when the appointed time had come, of which Elisha had told her. 2 KINGS 4:17

TRUE OR FALSE

105. ELISHA AND THE SHUNAMMITE WOMAN (2 KINGS 4:8-17)

V M X R H Q Y Q P J X J L G K
 L O O F G R N F N Y C Q M T I
 C N P W B O Y N U G B L S E Y
 L Y O P E D T F L A H S I L E
 V D O S L N O T N H B Z O L T
 N V R W B C P G Z D Y P A S F
 M U J V A X S H F E O Q L V Z
 J X Y G T R J D R O U O K P B
 C S M J O B O A H S N I F Z C
 M S G T N I C O H U Z A N S S
 Y O U N A R V T M A S L M M L
 S V U G X A D N H E W B M B S
 O Z O J H W T E R Q D A A A N
 J D V W P X G Y A M O L G N P
 I C V J T B T B A B K E I L D

CARE
 ELISHA
 FOOD
 GEHAZI

HUSBAND
 LIE
 MAN OF GOD

NOTABLE
 ROOM
 SON

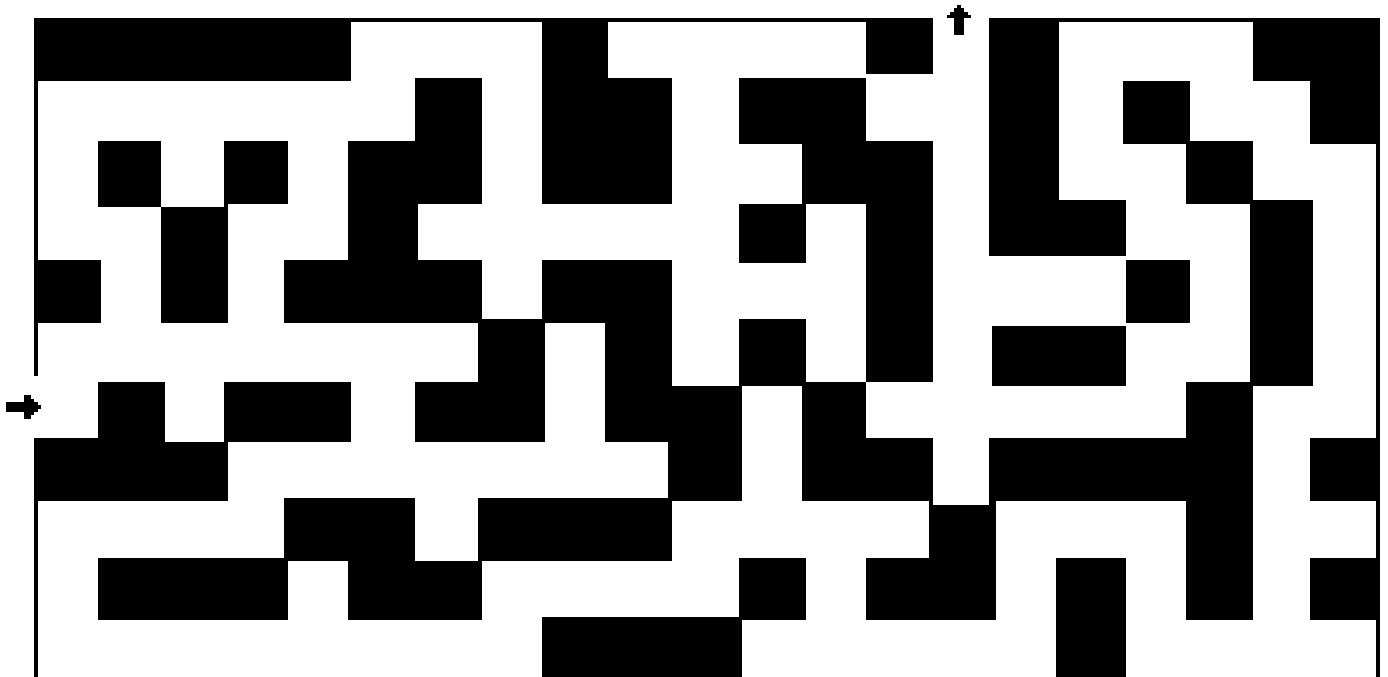

105. ELISHA AND THE SHUNAMMITE WOMAN

(2 KINGS 4:8-17)

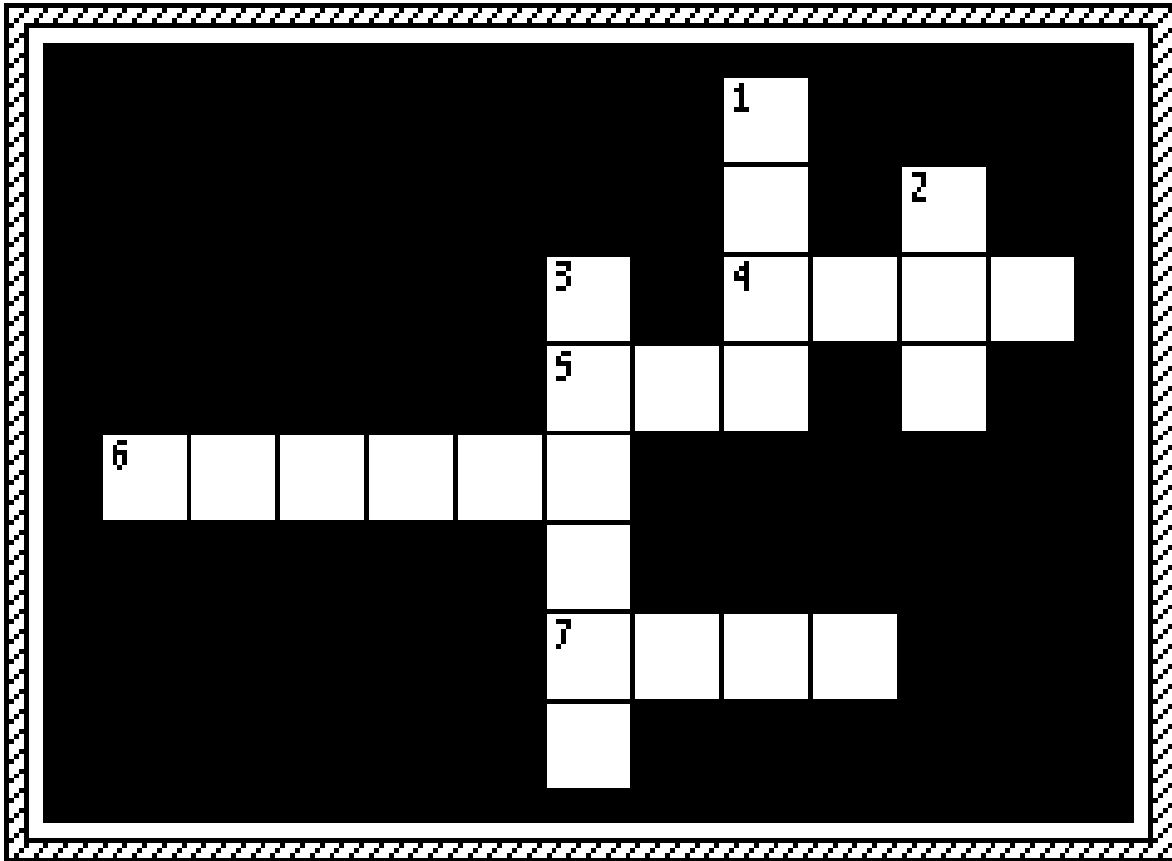

- 3 DOWN "Now it happened one day that _____ went to Shunem, where there was a notable woman, and she constrained him to eat some food." **2 KINGS 4:8**
- 7 ACROSS "And she said to her husband, 'Look now, I know that this is a _____ man of God, who passes by us regularly.'" **2 KINGS 4:9**
- 4 ACROSS She said, "Please, let us make a small upper _____ on the wall; and let us put a bed for him there, and a table and a chair and a lampstand; so it will be, whenever he comes to us, he can turn in there." **2 KINGS 4:10**
- 1 DOWN Elijah said to Gehazi his servant, 'Call this Shunammite woman.' When he called her, she stood before him. And he said to him, 'Say now to her, "Look, you have been concerned for us with all this _____. What can I do for you?"' " **2 KINGS 4:12-13**
- 6 ACROSS "_____ answered, 'Actually, she has no son, and her husband is old.'" **2 KINGS 4:14**
- 5 ACROSS "Then he said, 'About this time next year you shall embrace a son.' And she said, 'No, my lord. Man of God, do not _____ to your maidservant!'" **2 KINGS 4:16**
- 2 DOWN "And the woman conceived, and bore a _____ when the appointed time had come, of which Elisha had told her." **2 KINGS 4:17**

Bible Story 106

**ELISHA
RAISES A BOY
FROM THE DEAD**

2 KINGS 4:18-36

106. ELISHA RAISES A BOY FROM THE DEAD

(2 KINGS 4:18-36)



"And when Elisha was come into the house, behold, the child was dead, *and* laid upon his bed."

2 KINGS 4:32

"Then he returned, and walked in the house to and fro; and went up, and stretched himself upon him: and the child sneezed seven times, and the child opened his eyes."

2 KINGS 4:35

106. ELISHA RAISES A BOY FROM THE DEAD

(2 KINGS 4:18-36)

MEMORY VERSE:

"He went in therefore, shut the door behind the two of them, and prayed to the LORD." 2 KINGS 4:33

TRUE OR FALSE:

1. Now it happened one day that the Shunammite boy "went out to his father, to the reapers. And he said to his father, 'My head, my head!' So he said to a servant, 'Carry him to his mother.'" 2 KINGS 4:18-19

TRUE OR FALSE

2. "When he had taken him and brought him to his mother, he sat on her knees till noon, and then died." 2 KINGS 4:20

TRUE OR FALSE

CIRCLE THE CORRECT WORDS:

3. "And she went up and laid him on the (BED,CARPET) of the man of God, shut the door upon him, and went out." 2 KINGS 4:21
4. "So she departed, and went to the man of God at Mount (NEBO, CARMEL)." 2 KINGS 4:25
5. "Now when she came to the man of God at the hill, she caught him by the feet, but Gehazi came near to push her away. But the man of God said, 'Let her alone; for her soul is in deep distress, and the LORD has (HIDDEN, TAKEN) it from me, and has not told me.'" 2 KINGS 4:27

FILL IN THE BLANK:

6. "And she said, 'Did I ask a _____ of my lord? Did I not say, "Do not deceive me?" ' " 2 KINGS 4:28

TRUE OR FALSE:

7. "And when Elisha came into the house, there was the child, lying dead on his bed." 2 KINGS 4:32

TRUE OR FALSE

8. "He stretched himself out on the child, and the flesh of the child became warm." 2 KINGS 4:34

TRUE OR FALSE

CIRCLE THE CORRECT WORD:

9. "He returned and walked back and forth in the house, and again went up and stretched himself out on him; then the child (BLINKED, SNEEZED) seven times, and the child opened his eyes." 2 KINGS 4:35

106. ELISHA RAISES A BOY FROM THE DEAD

(2 KINGS 4:18-36)

D G B F V Y F E S P C Y T O K
C F L M U G L O R D X Y O O A
V Z O E D N Y Z D N C M J K G
O A U T W D E H C T E R T S S
S N P L L M O T H E R B Q P A
K S A M G E I C G S N P L Z U
L H H E E E M L P P R A Y E D
D U S Z E W H R C C P R P E K
F S I I B Y F A A N R Y B S S
A Y L I D N B W Z C E R V T Y
B J E D D E E C V I T E G V M
R N W Z V Z N D U P M N Y G P
X D C D I E D E D S O N U W L
E Y P P N U L A P I H X Q O K
W I R Z P G A Z I O H V D D M

BED

HIDDEN

OPENED

DIED

LORD

PRAYED

ELISHA

MOTHER

SON

GEHAZI

MOUNT CARMEL

STRETCHED

106. ELISHA RAISES A BOY FROM THE DEAD

(2 KINGS 4:18-36)

MEMORY VERSE:

"He went in therefore, shut the door behind the two of them, and prayed to the LORD." 2 KINGS 4:33

TRUE OR FALSE:

1. Now it happened one day that the Shunammite boy "went out to his father, to the reapers. And he said to his father, 'My head, my head!' So he said to a servant, 'Carry him to his mother.'" 2 KINGS 4:18-19

TRUE OR FALSE

2. "When he had taken him and brought him to his mother, he sat on her knees till noon, and then died." 2 KINGS 4:20

TRUE OR FALSE

FILL IN THE BLANKS:

3. "And she went up and laid him on the _____ of the man of God, shut the door upon him, and went out." 2 KINGS 4:21

4. "So she departed, and went to the man of God at Mount _____." 2 KINGS 4:25

5. "Now when she came to the man of God at the hill, she caught him by the feet, but Gehazi came near to push her away. But the man of God said, 'Let her alone; for her soul is in deep distress, and the LORD has _____ it from me, and has not told me.'" 2 KINGS 4:27

6. "And she said, 'Did I ask a _____ of my lord? Did I not say, "Do not deceive me?" ' " 2 KINGS 4:28

TRUE OR FALSE:

7. "And when Elisha came into the house, there was the child, lying dead on his bed." 2 KINGS 4:32

TRUE OR FALSE

8. "He stretched himself out on the child, and the flesh of the child became warm." 2 KINGS 4:34

TRUE OR FALSE

FILL IN THE BLANK:

9. "He returned and walked back and forth in the house, and again went up and stretched himself out on him; then the child sneezed seven times, and the child _____ his eyes." 2 KINGS 4:35

106. ELISHA RAISES A BOY FROM THE DEAD

(2 KINGS 4:18-36)

Z J L T D N K Z D V Q I H I R M E N N A
T A H H R N X R D E N E P O T H H O P Z
L G U T L S O D S Z C B V Y A O X A M H
Y F G P B L Z I S Z N K P W L P K R Y Q
D F I N H K Z E F M L G O Y S D M R A W
O O N C R A R E A M B L P M K E F L H W
W V L B H Y B E V M C O U R J I S B C I
S W T E D L O D H I E M U P X D E T G Y
R Q G F M N R C S T O L R Z R D Q D D M
Z T M O D R B C W X O T D P Q D V E J H
X C S V V O A L A O W M Y R M E H H D W
C Y N E D H B C W J P T M A O M K C O N
H N E M L M T G T U Y J D Y M K P T F E
J K E T M I C G W N V T L E G W W E W L
L K Z F V H S H Z B U H P D C C G R D I
E W E W I Z N H O O Z O Y I C W Q T U Z
O I D D P D P V A Y Y H M D L O V S I J
O J D Y T C O S R D S G E U T E Y W L Y
W E L F I V J O A A S J A K E U H L T K
N Q N E H E T N W U O J O L J U W A O M

BED

LORD

SNEEZED

DIED

MOTHER

SON

ELISHA

MOUNT CARMEL

STRETCHED

GEHAZI

OPENED

WARM

HIDDEN

PRAYED

106. ELISHA RAISES A BOY FROM THE DEAD

(2 KINGS 4:18-36)

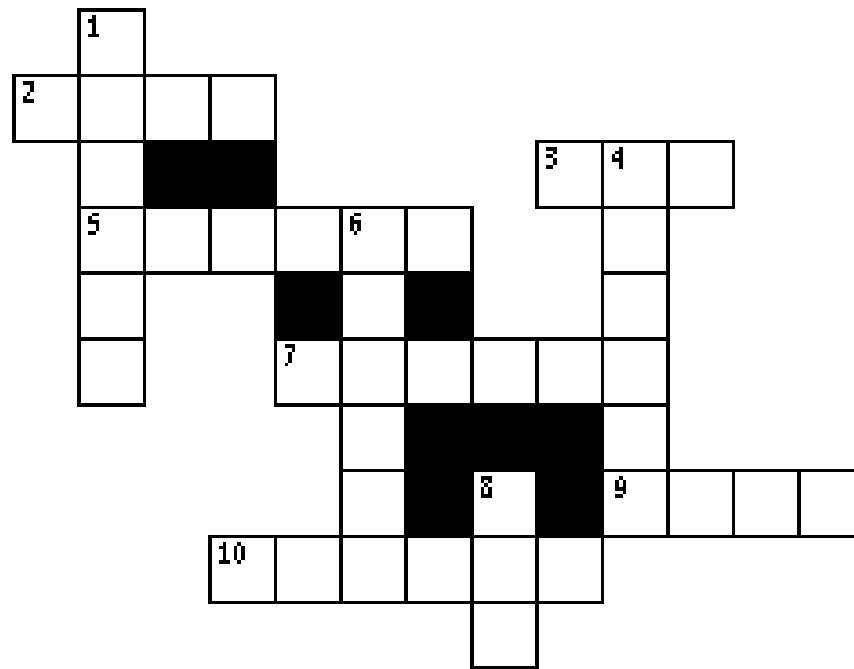

- 5 ACROSS Now it happened one day that the Shunammite boy "went out to his father, to the reapers. And he said to his father, 'My head, my head!' So he said to a servant, 'Carry him to his ____.'" **2 KINGS 4:18-19**
- 9 ACROSS "When he had taken him and brought him to his mother, he sat on her knees till noon, and then ____." **2 KINGS 4:20**
- 8 DOWN "And she went up and laid him on the ____ of the man of God, shut the door upon him, and went out." **2 KINGS 4:21**
- 1 DOWN "So she departed, and went to the man of God at Mount ____." **2 KINGS 4:25**
- 7 ACROSS "Now when she came to the man of God at the hill, she caught him by the feet, but Gehazi came near to push her away. But the man of God said, 'Let her alone; for her soul is in deep distress, and the LORD has ____ it from me, and has not told me.'" **2 KINGS 4:27**
- 3 ACROSS "And she said, 'Did I ask a ____ of my lord? Did I not say, "Do not deceive me?" ' " **2 KINGS 4:28**
- 6 DOWN "And when ____ came into the house, there was the child, lying dead on his bed." **2 KINGS 4:32**
- 10 ACROSS "He went in therefore, shut the door behind the two of them, and ____ to the LORD." **2 KINGS 4:33**
- 2 ACROSS "He stretched himself out on the child, and the flesh of the child became ____." **2 KINGS 4:34**
- 4 DOWN "He returned and walked back and forth in the house, and again went up and stretched himself out on him; then the child sneezed seven times, and the child ____ his eyes." **2 KINGS 4:35**

Bible Story 107

**NAAMAN'S
LEPROSY
IS HEALED**

2 KINGS 5:1-14

107. NAAMAN'S LEPROSY IS HEALED

(2 KINGS 5:1-14)



"So he went down and dipped seven times in the Jordan, according to the saying of the man of God; and his flesh was restored like the flesh of a little child, and he was clean."

2 KINGS 5:14

107. NAAMAN'S LEPROSY IS HEALED

(2 KINGS 5:1-14)

MEMORY VERSE:

"So he went down and dipped seven times in the Jordan, according to the saying of the man of God; and his flesh was restored like the flesh of a little child, and he was clean." 2 KINGS 5:14

CIRCLE THE CORRECT WORDS:

1. "(HEYMAN, NAAMAN), commander of the army of the king of Syria, was a great and honorable man in the eyes of his master, because by him the LORD had given victory to Syria." 2 KINGS 5:1
2. "He was also a mighty man of valor, but he was a (LEPER, PEPPER)." 2 KINGS 5:1

TRUE OR FALSE:

3. "The Syrians had gone out on raids, and had brought back captive a young girl from the land of Israel. She waited on Naaman's wife." 2 KINGS 5:2
TRUE OR FALSE

CIRCLE THE CORRECT WORDS:

4. "Then she said to her mistress, 'If only my master were with the prophet who is in Samaria! For he would (HEAL, PEEL) him of his leprosy.'" 2 KINGS 5:3
5. "So the king of Syria said, 'Go now, and I will send a (LETTER, CHARIOT) to the king of Israel.'" 2 KINGS 5:5

TRUE OR FALSE:

6. And it happened, when the king of Israel read the letter, he rejoiced because he could heal Naaman of his leprosy! 2 KINGS 5:7
TRUE OR FALSE
7. Elisha sent a messenger to Naaman, saying, "Go and wash in the Jordan seven times, and your flesh shall be restored to you, and you shall be clean." 2 KINGS 5:10
TRUE OR FALSE

CIRCLE THE CORRECT WORD:

8. "Naaman became (EXCITED, FURIOUS), and went away and said, 'Indeed, I said to myself, "He will surely come out to me.'" 2 KINGS 5:11

FILL IN THE BLANK:

9. "And his servants came near and spoke to him, and said, 'My father, if the prophet had told you to do something _____, would you not have done it? How much more then, when he says to you "Wash, and be clean?"' " 2 KINGS 5:13

TRUE OR FALSE:

10. "So he went down and dipped seven times in the Jordan, according to the saying of the man of God; and his flesh was restored like the flesh of a little child, and he was clean." 2 KINGS 5:14
TRUE OR FALSE

107. NAAMAN'S LEPROSY IS HEALED

(2 KINGS 5:1-14)

T R E T T E L R T V O H W G G
 B I F D Z B Z P F E J G Y Y Z
 I O H E K D H I A N L E P P J
 A W A S H E C Q D M A I Z Y P
 M V S N A I R Y S E J M S B N
 X Q A P K B T D Y A P U A H U
 L Z W Z Q J I J Y Z E P W A A
 E U L C J T O Q O S A W I D N
 P S E M I T N E V E S N B D O
 E A P C E R O T F H W A M R P
 R N E Q B N T R V M L D W C L
 T M S I B E A I G M Z R G G L
 C O M M A N D E R S L O F R M
 Y G G W R J A L L V P J I G S
 L L A E H Z N S S C J D X N Z

CLEAN
 COMMANDER
 DIPPED
 ELISHA
 HEAL

JORDAN
 LEPER
 LETTER
 NAAMAN

SEVEN TIMES
 SYRIANS
 TORE
 WASH

WRITE DOWN ALL THE LETTERS AS YOU COME TO THEM EXCEPT THE "X"'S ON THE LINES BELOW

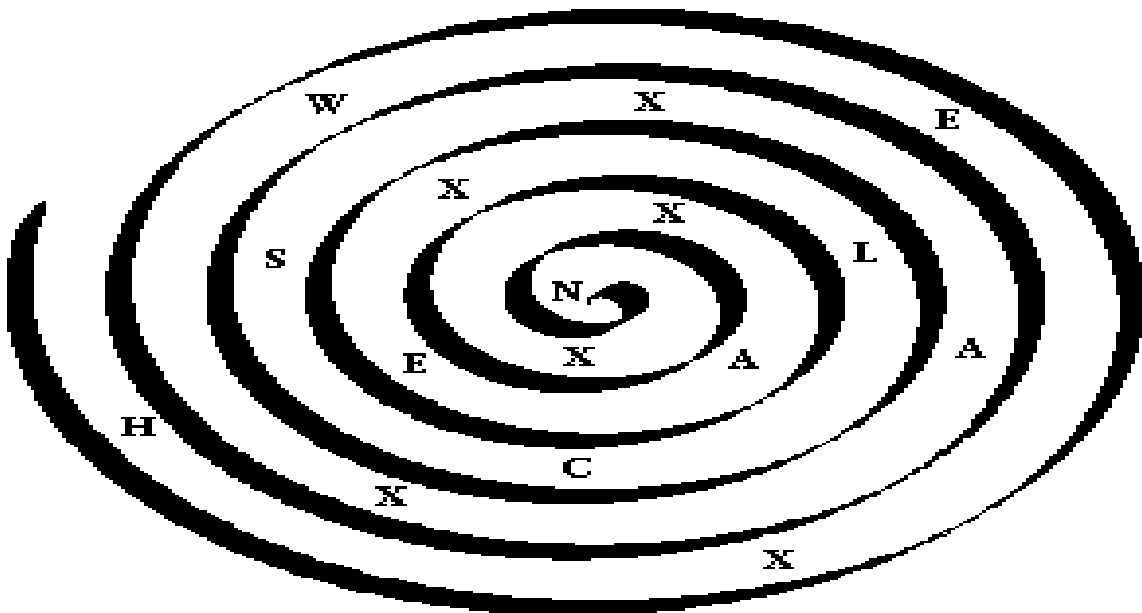

107. NAAMAN'S LEPROSY IS HEALED

(2 KINGS 5:1-14)

MEMORY VERSE:

"So he went down and dipped seven times in the Jordan, according to the saying of the man of God; and his flesh was restored like the flesh of a little child, and he was clean." 2 KINGS 5:14

FILL IN THE BLANKS:

1. "_____, commander of the army of the king of Syria, was a great and honorable man in the eyes of his master, because by him the LORD had given victory to Syria." **2 KINGS 5:1**
2. "He was also a mighty man of valor, but he was a _____." **2 KINGS 5:1**

TRUE OR FALSE:

3. "The Syrians had gone out on raids, and had brought back captive a young girl from the land of Israel. She waited on Naaman's wife." **2 KINGS 5:2**
TRUE OR FALSE

FILL IN THE BLANKS:

4. "Then she said to her mistress, 'If only my master were with the prophet who is in Samaria! For he would _____ him of his leprosy.'" **2 KINGS 5:3**
5. "So the king of Syria said, 'Go now, and I will send a _____ to the king of Israel.'" **2 KINGS 5:5**

TRUE OR FALSE:

6. And it happened, when the king of Israel read the letter, he rejoiced because he could heal Naaman of his leprosy! **2 KINGS 5:7**
TRUE OR FALSE
7. Elisha sent a messenger to Naaman, saying, "Go and wash in the Jordan seven times, and your flesh shall be restored to you, and you shall be clean." **2 KINGS 5:10**
TRUE OR FALSE

FILL IN THE BLANKS:

8. "Naaman became _____, and went away and said, 'Indeed, I said to myself, "He will surely come out to me." ' " **2 KINGS 5:11**
9. "And his servants came near and spoke to him, and said, 'My father, if the prophet had told you to do something _____, would you not have done it? How much more then, when he says to you "Wash, and be clean"?' " **2 KINGS 5:13**

TRUE OR FALSE:

10. "So he went down and dipped seven times in the Jordan, according to the saying of the man of God; and his flesh was restored like the flesh of a little child, and he was clean." **2 KINGS 5:14**
TRUE OR FALSE

107. NAAMAN'S LEPROSY IS HEALED

(2 KINGS 5:1-14)

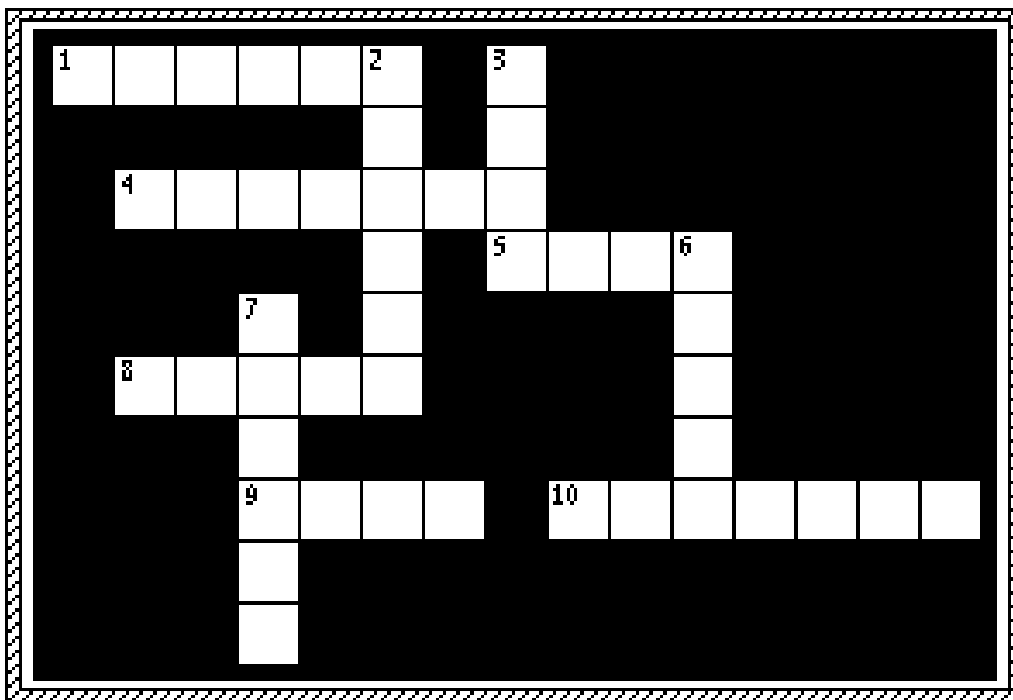

- 2 DOWN "____, commander of the army of the king of Syria, was a great and honorable man in the eyes of his master, because by him the LORD had given victory to Syria." **2 KINGS 5:1**
- 6 DOWN "He was also a mighty man of valor, but he was a ____." **2 KINGS 5:1**
- 4 ACROSS "The ____ had gone out on raids, and had brought back captive a young girl from the land of Israel. She waited on Naaman's wife." **2 KINGS 5:2**
- 5 ACROSS "Then she said to her mistress, 'If only my master were with the prophet who is in Samaria! For he would ____ him of his leprosy.'" **2 KINGS 5:3**
- 7 DOWN "So the king of Syria said, 'Go now, and I will send a ____ to the king of Israel.'" **2 KINGS 5:5**
- 9 ACROSS "And it happened, when the king of Israel read the letter, that he ____ his clothes." **2 KINGS 5:7**
- 1 ACROSS Elisha sent a messenger to Naaman, saying, "Go and wash in the ____ seven times, and your flesh shall be restored to you, and you shall be clean." **2 KINGS 5:10**
- 10 ACROSS "Naaman became ____, and went away and said, 'Indeed, I said to myself, "He will surely come out to me."'" **2 KINGS 5:11**
- 3 DOWN "And his servants came near and spoke to him, and said, 'My father, if the prophet had told you to do something great, would you not have done it? How much more then, when he says to you "____, and be clean"?' " **2 KINGS 5:13**
- 8 ACROSS "So he went down and dipped seven times in the Jordan, according to the saying of the man of God; and his flesh was restored like the flesh of a little child, and he was ____." **2 KINGS 5:14**

Bible Story 108

**ELISHA'S
GREEDY SERVANT**

2 KINGS 5:15-27

108. ELISHA'S GREEDY SERVANT

(2 KINGS 5:15-27)



"The leprosy therefore of Naaman shall cleave unto thee, and unto thy seed for ever.
And he went out from his presence a leper as *white* as snow."
2 KINGS 5:27

108. ELISHA'S GREEDY SERVANT

(2 KINGS 5:15-27)

MEMORY VERSE:

"Did not my heart go with you when the man turned back from his chariot to meet you? Is it time to receive money and to receive clothing, olive groves and vineyards, sheep and oxen, male and female servants?" 2 KINGS 5:26

TRUE OR FALSE:

1. Naaman "returned to the man of God, he and all his aides, and came and stood before him; and he said, 'Indeed, now I know that there is no God in all the earth, except in Israel.' " **2 KINGS 5:15**
TRUE OR FALSE

CIRCLE THE CORRECT WORDS:

2. He said, "Now therefore, please take a (**PUNCH, GIFT**) from your servant." **2 KINGS 5:15**
3. Elisha said, "As the LORD lives, before whom I stand, I will receive (**NOTHING, EVERYTHING**)."
2 KINGS 5:16
4. Elisha "said to him, 'Go in peace.' So he departed from him a (**SHORT, LONG**) distance." **2 KINGS 5:19**

TRUE OR FALSE:

5. "But Gehazi, the servant of Elisha the man of God, said, 'Look, my master has spared Naaman this Syrian, while not receiving from his hands what he brought; but as the LORD lives, I will run after him and take something from him.' " **2 KINGS 5:20**
TRUE OR FALSE
6. But Gehazi changed his mind and did not pursue Naaman. **2 KINGS 5:21**
TRUE OR FALSE

CIRCLE THE CORRECT WORD:

7. Gehazi said to Naaman, "All is well. My master has sent me, saying, 'Indeed, just now two young men of the sons of the prophets have come to me from the mountains of Ephraim. Please give them a talent of (**GOLD, SILVER**) and two changes of (**GARMENTS, CURTAINS**).' " **2 KINGS 5:22**
8. "So Naaman said, 'Please take (**NO, TWO**) talents.' " **2 KINGS 5:23**

UNDERLINE THE CORRECT ANSWER:

9. "Now he went in and stood before his master. And Elisha said to him..." **2 KINGS 5:25**
 - a. Where did you go, Gehazi?
 - b. Did you get anything for me too?

TRUE OR FALSE:

10. Then Elisha "said to him, 'Did not my heart go with you when the man turned back from his chariot to meet you?' " **2 KINGS 5:26**
TRUE OR FALSE
11. He said, "Therefore the leprosy of Naaman shall cling to you and your descendants forever.' And he went out from his presence leprous, as white as snow." **2 KINGS 5:27**
TRUE OR FALSE

108. ELISHA'S GREEDY SERVANT

(2 KINGS 5:15-27)

I J T D O W O Q E E Q A Z B Y
T L M S B O M F L C Y S B K T
R B P T R W C U I N C M P R O
E N U T N T A N S A L U A S S
V T A L E N T S H T V E M U U
L Z G G S H C Q A S H Z B I I
I Z P E A Z B G N I X O U S B
S Q R U H R X Y B D O B R I U
E N P W R A M T S G B A F Y G
H T F I G S Z E N O E H S N D
I N T N A N U I N L R W U O O
N A M A A N H E I T I P G W X
X P Y G G T N C D A S C E Y N
O G W F O M I A B H B E Y L T
E D Y N P B M B G Q M R P F D

DISTANCE

GOD

NOTHING

ELISHA

HEART

PURSUED

GARMENTS

ISRAEL

SILVER

GEHAZI

LEPROSY

TALENTS

GIFT

NAAMAN

108. ELISHA'S GREEDY SERVANT

(2 KINGS 5:15-27)

MEMORY VERSE:

"Did not my heart go with you when the man turned back from his chariot to meet you? Is it time to receive money and to receive clothing, olive groves and vineyards, sheep and oxen, male and female servants?" 2 KINGS 5:26

TRUE OR FALSE:

1. Naaman "returned to the man of God, he and all his aides, and came and stood before him; and he said, 'Indeed, now I know that there is no God in all the earth, except in Israel.' " **2 KINGS 5:15**
TRUE OR FALSE

FILL IN THE BLANKS:

2. He said, "Now therefore, please take a _____ from your servant." **2 KINGS 5:15**
3. Elisha said, "As the LORD lives, before whom I stand, I will receive _____." **2 KINGS 5:16**
4. Elisha "said to him, 'Go in peace.' So he departed from him a _____ distance." **2 KINGS 5:19**

TRUE OR FALSE:

5. "But Gehazi, the servant of Elisha the man of God, said, 'Look, my master has spared Naaman this Syrian, while not receiving from his hands what he brought; but as the LORD lives, I will run after him and take something from him.' " **2 KINGS 5:20**
TRUE OR FALSE
6. But Gehazi changed his mind and did not pursue Naaman. **2 KINGS 5:21**
TRUE OR FALSE

FILL IN THE BLANKS:

7. Gehazi said to Naaman, "All is well. My master has sent me, saying, 'Indeed, just now two young men of the sons of the prophets have come to me from the mountains of Ephraim. Please give them a talent of _____ and two changes of _____.'" **2 KINGS 5:22**
8. "So Naaman said, 'Please take _____ talents.'" **2 KINGS 5:23**

UNDERLINE THE CORRECT ANSWER:

9. "Now he went in and stood before his master. And Elisha said to him..." **2 KINGS 5:25**
a. Where did you go, Gehazi?
b. Did you get anything for me too?

TRUE OR FALSE:

10. Then Elisha "said to him, 'Did not my heart go with you when the man turned back from his chariot to meet you?' " **2 KINGS 5:26**
TRUE OR FALSE
11. He said, " 'Therefore the leprosy of Naaman shall cling to you and your descendants forever.' And he went out from his presence leprous, as white as snow." **2 KINGS 5:27**
TRUE OR FALSE

108. ELISHA'S GREEDY SERVANT

(2 KINGS 5:15-27)

T D S N D G Z D Z R B H D G O V X C T N
B T E Z E O U N S I L V E R Y M M R L G
Y N Q H G F G M S J O R I H K G G H C W
K Y A P T Z D S V Z J N P G E D Q N M S
Y Z M Q E B F H M F B N M A H S I L E C
I B B L L C H E O J V M W N O O O T N T
T P X A S S G P C S G D L W J T F O G P
P M C L V T U P T N W O G B S I T N N M
S U B L P L R N N F A F S W G H T V M S
J L B M Z S E A Y E H T Z B I C H G P D
V N Y S S M Q S E O H G S N Z U R R E Q
D Z U O R N O R G H T Q G I N V W K I H
T H W A M R J B I R B A R V D N W Z P E
T R G A P P V N C I X R L D E U S R U P
Q A D E B M Q G N Y B V O E N V V L L N
F A L L A N D B E S L D J A N M L E L P
N J O K K Q D L B Y L F M B W T A N E T
F Y K N I Q D L P D Y A L H I R S I P L
T G J M Y H V N U Y A H L C S U R V K Z
H H Q G T V V X U N L L A I O O Q V S T

DISTANCE

GOD

NOTHING

ELISHA

HEART

PURSUED

GARMENTS

ISRAEL

SILVER

GEHAZI

LEPROSY

TALENTS

GIFT

NAAMAN

108. ELISHA'S GREEDY SERVANT

(2 KINGS 5:15-27)

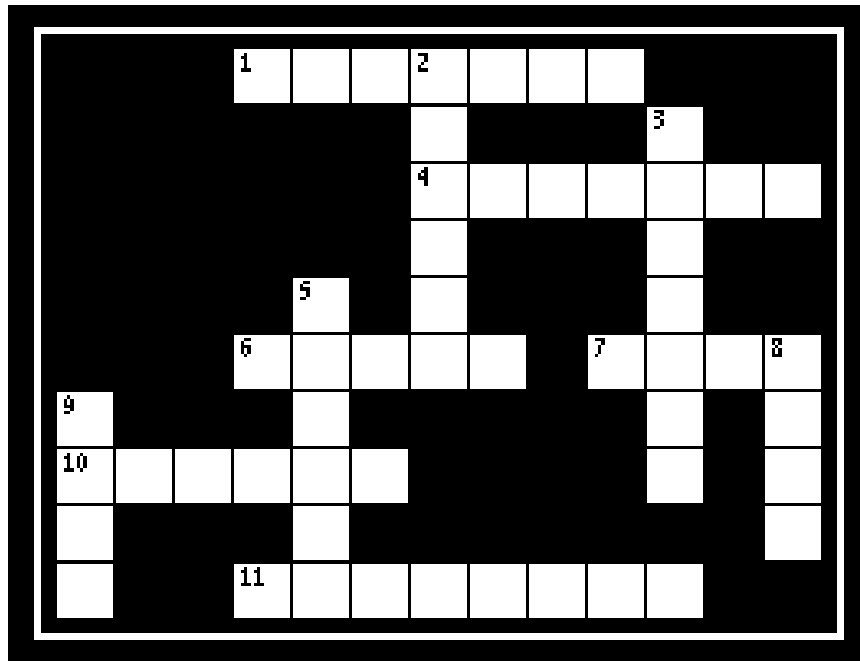

- 9 DOWN Naaman "returned to the man of God, he and all his aides, and came and stood before him; and he said, 'Indeed, now I _____ that there is no God in all the earth, except in Israel.'" **2 KINGS 5:15**
- 7 ACROSS He said, "Now therefore, please take a _____ from your servant." **2 KINGS 5:15**
- 3 DOWN Elisha said, "As the LORD lives, before whom I stand, I will receive _____." **2 KINGS 5:16**
- 11 ACROSS Elisha "said to him, 'Go in peace.' So he departed from him a short _____." **2 KINGS 5:19**
- 8 DOWN "But Gehazi, the servant of Elisha the man of God, said, 'Look, my master has spared Naaman this Syrian, while not receiving from his hands what he brought; but as the LORD lives, I will run after him and _____ something from him.'" **2 KINGS 5:20**
- 1 ACROSS "So Gehazi _____ Naaman." **2 KINGS 5:21**
- 2 DOWN Gehazi said to Naaman, "All is well. My master has sent me, saying, 'Indeed, just now two young men of the sons of the prophets have come to me from the mountains of Ephraim. Please give them a talent of _____ and two changes of garments.'" **2 KINGS 5:22**
- 10 ACROSS "So _____ said, 'Please take two talents.'" **2 KINGS 5:23**
- 5 DOWN "Now he went in and stood before his master. And Elisha said to him, 'Where did you go, _____?'" **2 KINGS 5:25**
- 6 ACROSS Then Elisha "said to him, 'Did not my _____ go with you when the man turned back from his chariot to meet you?'" **2 KINGS 5:26**
- 4 ACROSS He said, " 'Therefore the _____ of Naaman shall cling to you and your descendants forever.' And he went out from his presence leprous, as white as snow." **2 KINGS 5:27**

Bible Story 109

**THE FLOATING
AX HEAD**

2 KINGS 6:1-7

109. THE FLOATING AX HEAD

(2 KINGS 6:1-7)



"But as one was cutting down a tree, the iron ax head fell into the water; and he cried out and said, 'Alas, master! For it was borrowed.' "

2 KINGS 6:5

109. THE FLOATING AX HEAD

(2 KINGS 6:1-7)

MEMORY VERSE:

"But as one was cutting down a tree, the iron ax head fell into the water; and he cried out and said, 'Alas, master! For it was borrowed.' " 2 KINGS 6:5

CIRCLE THE CORRECT WORD:

1. "The sons of the prophets said to Elisha, 'See now, the place where we dwell with you is too (SMALL, LARGE) for us.' " 2 KINGS 6:1

TRUE OR FALSE:

2. They said, "Please, let us go to the Jordan, and let every man take a beam from there, and let us make there a place where we may dwell." 2 KINGS 6:2

TRUE OR FALSE

3. And Elisha answered, "No." 2 KINGS 6:2

TRUE OR FALSE

CIRCLE THE CORRECT WORD:

4. "Then one said, 'Please consent to go with your servants.' And he answered, 'I (WILL, WILL NOT) go.' " 2 KINGS 6:3

TRUE OR FALSE:

5. "When they came to the Jordan, they cut down trees." 2 KINGS 6:4

TRUE OR FALSE

6. "But as one was cutting down a tree, the iron ax head fell into the water." 2 KINGS 6:5

TRUE OR FALSE

CIRCLE THE CORRECT WORD:

7. "He cried out and said, 'Alas, master! For it was (MINE, BORROWED).' " 2 KINGS 6:5

8. "And the man of God said, 'Where did it (FLY, FALL)?' And he showed him the place." 2 KINGS 6:6

FILL IN THE BLANK:

9. "So he cut off a stick, and threw it in there; and he made the iron _____." 2 KINGS 6:6

TRUE OR FALSE:

10. "Therefore he said, 'Pick it up for yourself.' So he reached out his hand and took it." 2 KINGS 6:7

TRUE OR FALSE

109. THE FLOATING AX HEAD

(2 KINGS 6:1-7)

J O R D A N G V D B
E D W E L L D A O O
L C B E A M E R P R
I U G P H H R Z R C
S T F H X O F Y O C
H T S A W U L S P W
A I I E L A O M H A
A N D C E L A A E T
B G Q C K R T L T E
I R O N L B T L S R

AX HEAD

BEAM

BORROWED

CUTTING

DWELL

ELISHA

FALL

FLOAT

IRON

JORDAN

PROPHETS

SMALL

STICK

TREES

WATER

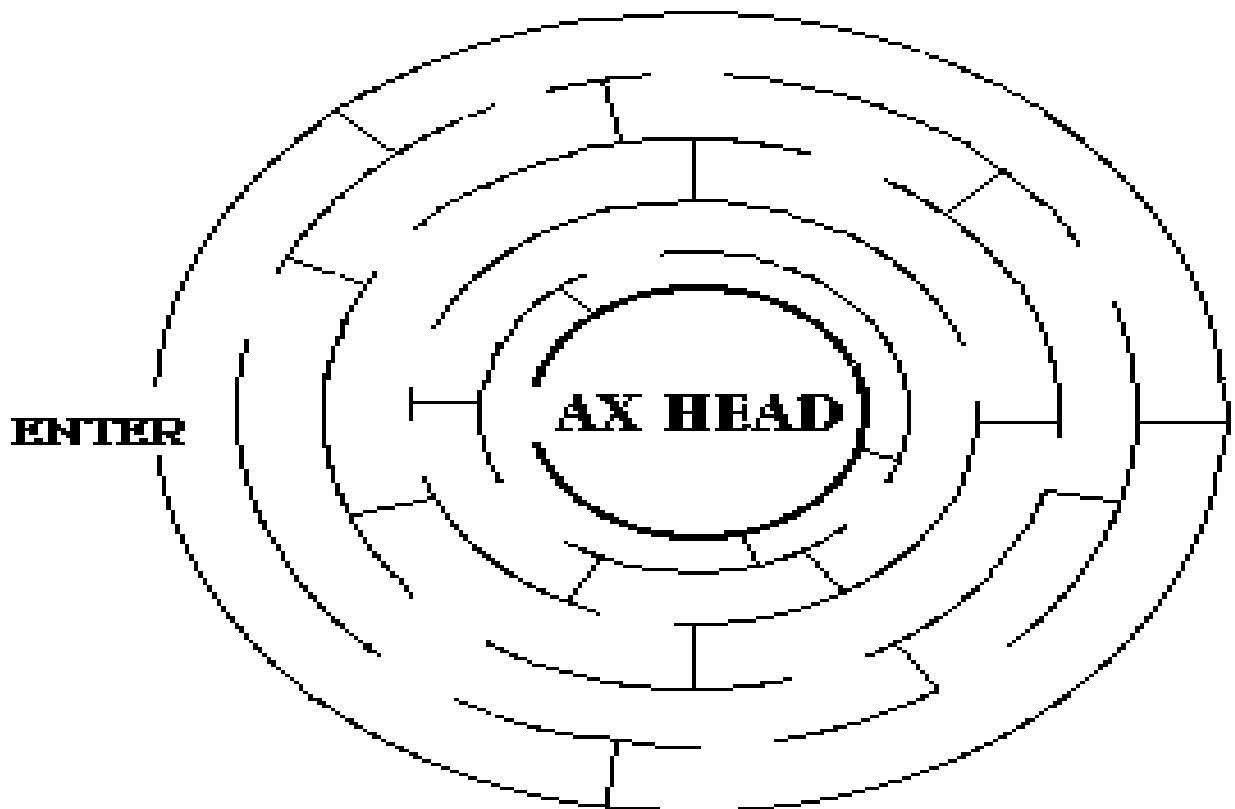

109. THE FLOATING AX HEAD

(2 KINGS 6:1-7)

MEMORY VERSE:

"But as one was cutting down a tree, the iron ax head fell into the water; and he cried out and said, 'Alas, master! For it was borrowed.' " 2 KINGS 6:5

FILL IN THE BLANK:

1. "The sons of the prophets said to Elisha, 'See now, the place where we dwell with you is too _____ for us.' " 2 KINGS 6:1

TRUE OR FALSE:

2. They said, "Please, let us go to the Jordan, and let every man take a beam from there, and let us make there a place where we may dwell." 2 KINGS 6:2
TRUE OR FALSE
3. And Elisha answered, "No." 2 KINGS 6:2
TRUE OR FALSE

FILL IN THE BLANK:

4. "Then one said, 'Please _____ to go with your servants.' And he answered, 'I will go.' " 2 KINGS 6:3

TRUE OR FALSE:

5. "When they came to the Jordan, they cut down trees." 2 KINGS 6:4
TRUE OR FALSE
6. "But as one was cutting down a tree, the iron ax head fell into the water." 2 KINGS 6:5
TRUE OR FALSE

FILL IN THE BLANKS:

7. "He cried out and said, 'Alas, master! For it was _____.'" 2 KINGS 6:5
8. "And the man of God said, 'Where did it _____?' And he showed him the place." 2 KINGS 6:6
9. "So he cut off a stick, and threw it in there; and he made the iron _____." 2 KINGS 6:6

TRUE OR FALSE:

10. "Therefore he said, 'Pick it up for yourself.' So he reached out his hand and took it." 2 KINGS 6:7
TRUE OR FALSE

109. THE FLOATING AX HEAD

(2 KINGS 6:1-7)

N C O S W M H S H H J G V T R
M N R E M A L Z G C S D M H H
Z E I E L A T R N O Z F A L L
S B Y R S D L E W D A E H X A
V P S T T D E L R Y N O M K N
M U Y W E O D W B N W T C K N
B E A M H F I O O T A I H W V
O U D H P D P J A R T D N W G
I R Y H O X W O C S R A R X R
R J B B R Q L E W U H O M O K
O Z O X P F M L L S T C B L J
N F J B H R W L I L I T G R Z
N J L U G K L L B K O U I Q L
G F V L L D E A V E V V Q N X
I E G Y L F G G B O M N O C G

AX HEAD
BEAM
BORROWED
CUTTING
DWELL

ELISHA
FALL
FLOAT
IRON
JORDAN

PROPHETS
SMALL
STICK
TREES
WATER

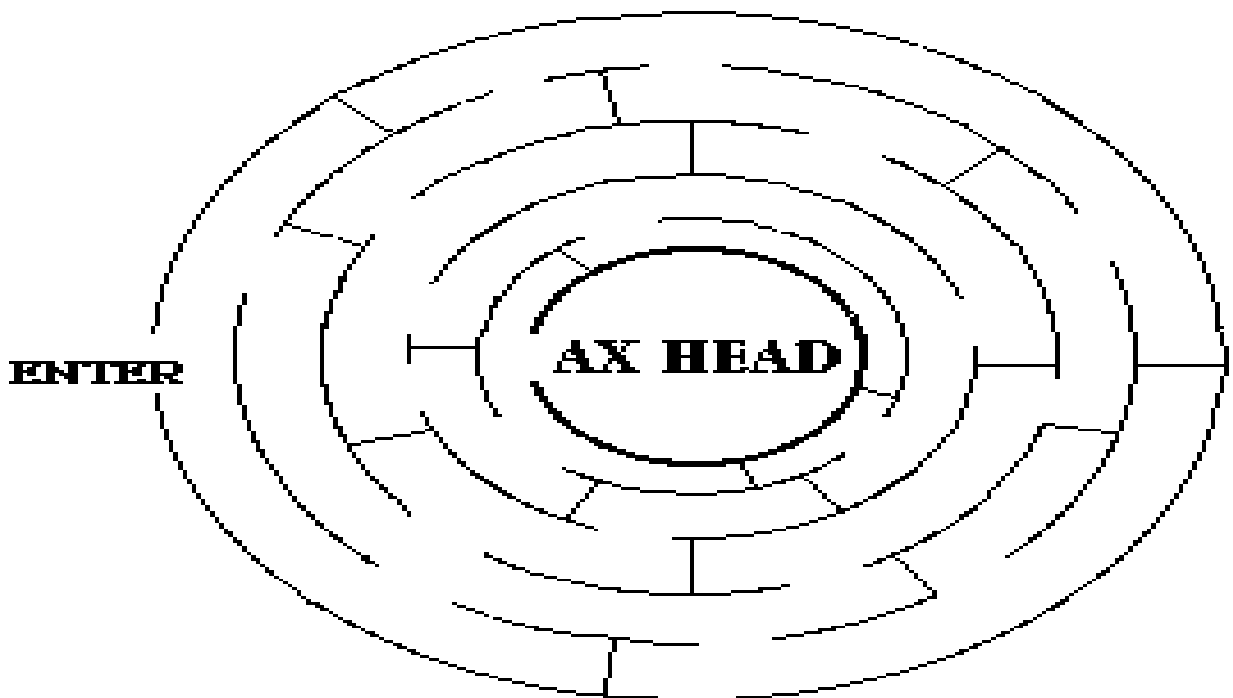

109. THE FLOATING AX HEAD

(2 KINGS 6:1-7)

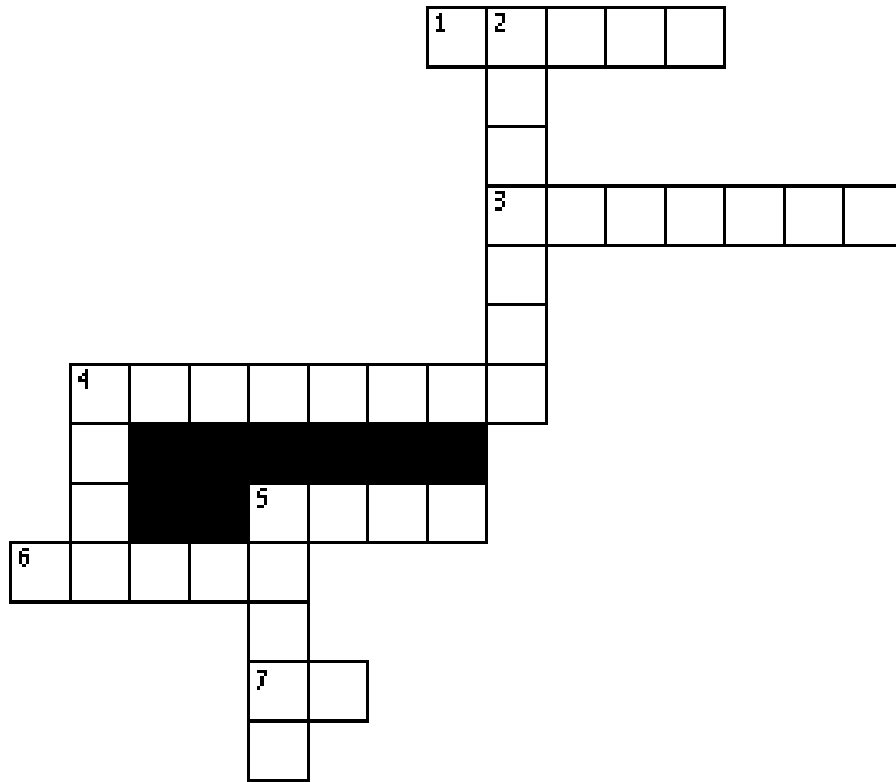

- 6 ACROSS "The sons of the prophets said to Elisha, 'See now, the place where we dwell with you is too _____ for us.'" **2 KINGS 6:1**
- 4 DOWN They said, "Please, let us go to the Jordan, and let every man take a _____ from there, and let us make there a place where we may dwell." **2 KINGS 6:2**
- 3 ACROSS "Then one said, 'Please _____ to go with your servants.' And he answered, 'I will go.'" **2 KINGS 6:3**
- 1 ACROSS "When they came to the Jordan, they cut down _____." **2 KINGS 6:4**
- 7 ACROSS "But as one was cutting down a tree, the iron _____ head fell into the water." **2 KINGS 6:5**
- 4 ACROSS "He cried out and said, 'Alas, master! For it was _____.'" **2 KINGS 6:5**
- 5 ACROSS "And the man of God said, 'Where did it _____?' And he showed him the place." **2 KINGS 6:6**
- 5 DOWN "So he cut off a stick, and threw it in there; and he made the iron _____." **2 KINGS 6:6**
- 2 DOWN "Therefore he said, 'Pick it up for yourself.' So he _____ out his hand and took it." **2 KINGS 6:7**

Bible Story 110

**A SERVANT SEES A
FIERY ARMY**

2 KINGS 6:8-23

110. A SERVANT SEES A FIERY ARMY

(2 KINGS 6:8-23)



"Then the LORD opened the eyes of the young man, and he saw. And behold, the mountain was full of horses and chariots of fire all around Elisha."

2 KINGS 6:17

110. A SERVANT SEES A FIERY ARMY

(2 KINGS 6:8-23)

MEMORY VERSE:

"Then the LORD opened the eyes of the young man, and he saw. And behold, the mountain was full of horses and chariots of fire all around Elisha." 2 KINGS 6:17

CIRCLE THE CORRECT WORD:

1. "Now the king of Syria was making (**TALK**, **WAR**) against Israel; and he took counsel with his servants, saying, 'My camp will be in such and such a place.' " **2 KINGS 6:8**

TRUE OR FALSE:

2. "And the man of God sent to the king of Israel, saying, 'Beware that you do not pass this place, for the Syrians are coming down there.' " **2 KINGS 6:9**

TRUE OR FALSE

3. But the king of Israel did not listen and did not send anyone to the place of which the man of God had told him. **2 KINGS 6:10**

TRUE OR FALSE

CIRCLE THE CORRECT WORD:

4. "Therefore the heart of the king of Syria was greatly (**TROUBLED**, **BUBBLED**) by this thing; and he called his servants and said to them, 'Will you not show me which of us is for the king of Israel?' " **2 KINGS 6:11**

FILL IN THE BLANK:

5. "And one of his servants said, 'None, my lord, O king; but _____, the prophet who is in Israel, tells the king of Israel the words that you speak in your bedroom.' " **2 KINGS 6:12**

TRUE OR FALSE:

6. "So he said, 'Go and see where he is, that I may send and get him.' And it was told him, saying, 'Surely he is in Dothan.' " **2 KINGS 6:13**

TRUE OR FALSE

7. "Therefore he sent horses and chariots and a great army there, and they came by night and surrounded the city." **2 KINGS 6:14**

TRUE OR FALSE

CIRCLE THE CORRECT WORDS:

8. "And when the servant of the man of God arose early and went out, there was an army, (**SURROUNDING**, **LEAVING**) the city with horses and chariots. And his servant said to him, 'Alas, my master! What shall we do?' " **2 KINGS 6:15**

9. "So he answered, 'Do not fear, for those who are with us are (**MORE**, **LESS**) than those who are with them.' " **2 KINGS 6:16**

10. "And Elisha prayed, and said, 'LORD, I pray, open his eyes that he may see.' Then the LORD opened the eyes of the young man, and he saw. And behold, the mountain was (**EMPTY**, **FULL**) of horses and chariots of fire all around Elisha." **2 KINGS 6:17**

11. "So when the Syrians came down to him,, Elisha prayed to the LORD, and said, 'Strike this people, I pray, with (**KINDNESS**, **BLINDNESS**).' " **2 KINGS 6:18**

12. "Now Elisha said to them, 'This is not the way, nor is this the city. Follow me, and I will bring you to the man whom you seek.' But he led them to (**SAMARIA**, **SYRIA**). " **2 KINGS 6:19**

110. A SERVANT SEES A FIERY ARMY

(2 KINGS 6:8-23)

J T F E Y E S E M Y Q P N V F
 Q V L S I F I S R A E L V E G
 L G K O P R H Z Q H W L D M I
 P W I E K S S E N D N I L B E
 V D Q Z D S E R V A N T I N G
 G K D P S E Y U B F G O M B W
 Y A E E R A D U V Q L P O A K
 Q G L U E C M N B X W D O S G
 D S B V N G G A U H D Q F P N
 O A U F A O M Y R O I J U W I
 O L O I I W X M W I R J D J K
 K K R U P J U R Y M A R R H O
 P S T S Y R I A N S C A U N I
 Z Y S H Q V V I U G W C I S L
 S J N A H T O D K A H S I L E

ARMY
 BLINDNESS
 DOTHAN
 ELISHA
 EYES

ISRAEL
 KING
 SAMARIA
 SERVANT

SURROUNDED
 SYRIANS
 TROUBLED
 WAR

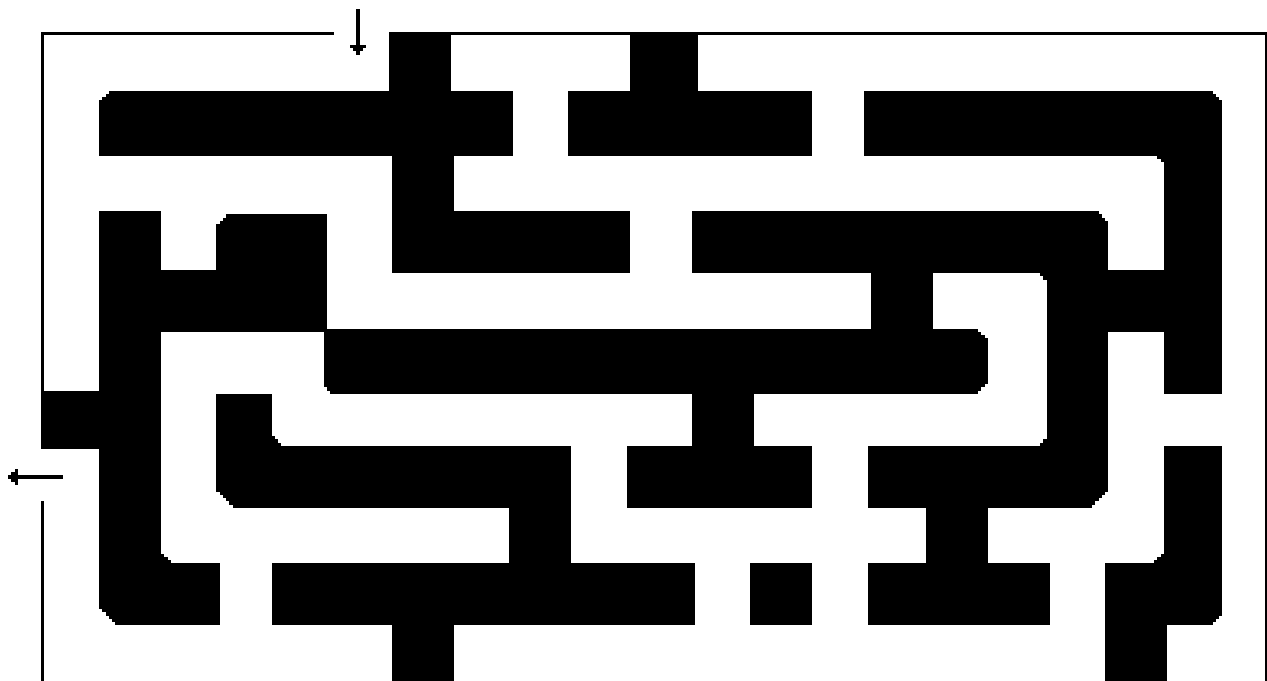

110. A SERVANT SEES A FIERY ARMY

(2 KINGS 6:8-23)

MEMORY VERSE:

"Then the LORD opened the eyes of the young man, and he saw. And behold, the mountain was full of horses and chariots of fire all around Elisha." 2 KINGS 6:17

FILL IN THE BLANK:

1. "Now the king of Syria was making _____ against Israel; and he took counsel with his servants, saying, 'My camp will be in such and such a place.' " **2 KINGS 6:8**

TRUE OR FALSE:

2. "And the man of God sent to the king of Israel, saying, 'Beware that you do not pass this place, for the Syrians are coming down there.' " **2 KINGS 6:9**

TRUE OR FALSE

3. But the king of Israel did not listen and did not send anyone to the place of which the man of God had told him. **2 KINGS 6:10**

TRUE OR FALSE

FILL IN THE BLANKS:

4. "Therefore the heart of the king of Syria was greatly _____ by this thing; and he called his servants and said to them, 'Will you not show me which of us is for the king of Israel?' " **2 KINGS 6:11**

5. "And one of his servants said, 'None, my lord, O king; but _____, the prophet who is in Israel, tells the king of Israel the words that you speak in your bedroom.' " **2 KINGS 6:12**

TRUE OR FALSE:

6. "So he said, 'Go and see where he is, that I may send and get him.' And it was told him, saying, 'Surely he is in Dothan.' " **2 KINGS 6:13**

TRUE OR FALSE

7. "Therefore he sent horses and chariots and a great army there, and they came by night and surrounded the city." **2 KINGS 6:14**

TRUE OR FALSE

FILL IN THE BLANKS:

8. "And when the servant of the man of God arose early and went out, there was an army, _____ the city with horses and chariots. And his servant said to him, 'Alas, my master! What shall we do?' " **2 KINGS 6:15**

9. "So he answered, 'Do not fear, for those who are with us are _____ than those who are with them.' " **2 KINGS 6:16**

10. "And Elisha prayed, and said, 'LORD, I pray, open his eyes that he may see.' Then the LORD opened the eyes of the young man, and he saw. And behold, the mountain was _____ of horses and chariots of fire all around Elisha." **2 KINGS 6:17**

11. "So when the Syrians came down to him,, Elisha prayed to the LORD, and said, 'Strike this people, I pray, with _____.' " **2 KINGS 6:18**

12. "Now Elisha said to them, 'This is not the way, nor is this the city. Follow me, and I will bring you to the man whom you seek.' But he led them to _____." **2 KINGS 6:19**

110. A SERVANT SEES A FIERY ARMY

(2 KINGS 6:8-23)

S Y F V P Q S B T T S D G U M K H J O O
 J T N A V R E S I F V W Y O D O A H E E
 F N H B J Z G B O A O E S F L I H Q W P
 F M N Q T U D R T Y J L P N S T Z O E T
 O H G Y B A E B A Y J I Y L A E Y A B C
 P L A I R A M A S O E S B L V I N W K S
 E D L E I N P K N F A H D M W A R V S C
 L R A L A M Z E R V W A R S R J J Y U H
 O E G R M G C F P J L Y C Z C K T M S U
 I U R N M F C J I S S P G M M K P F H E
 S W Q V L Y Q T Q V Z U R P L P L S P C
 R S S E N D N I L B H Z R G B Z J N E N
 A J I Q T H I E D M P W G R X Y A W V Q
 E N P T Y A W J J A J B N K O H C U A L
 L S H A L W Z S Q Z H M G B T U V D R K
 C Z Z Q I G K Z E S G W Z O A Y N S L D
 T R O U B L E D R Y E U D U C O T D W D
 F K I L O P K Z I H E F J P W J W J E O
 K B G N I K Q K L M U I P C J P H H J D
 B Z V H V E J C S P W X N U U A P Q U K

ARMY
 BLINDNESS
 DOTHAN
 ELISHA
 EYES

ISRAEL
 KING
 SAMARIA
 SERVANT

SURROUNDED
 SYRIANS
 TROUBLED
 WAR

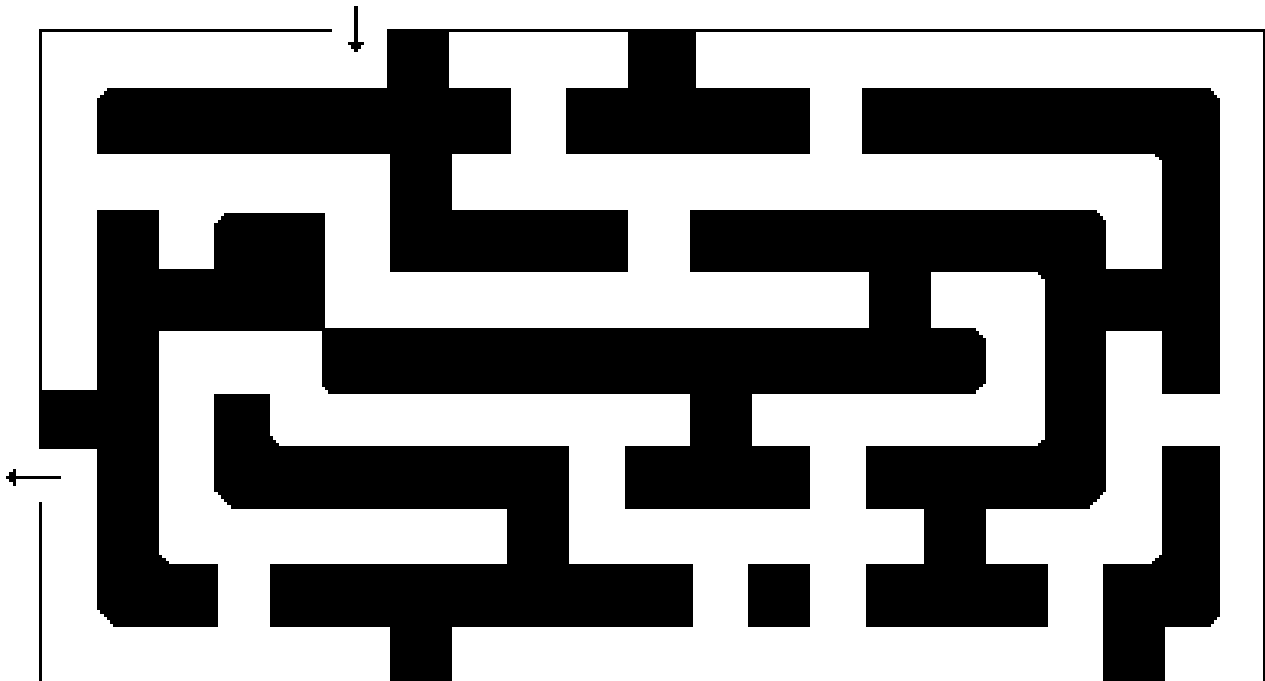

110. A SERVANT SEES A FIERY ARMY

(2 KINGS 6:8-23)

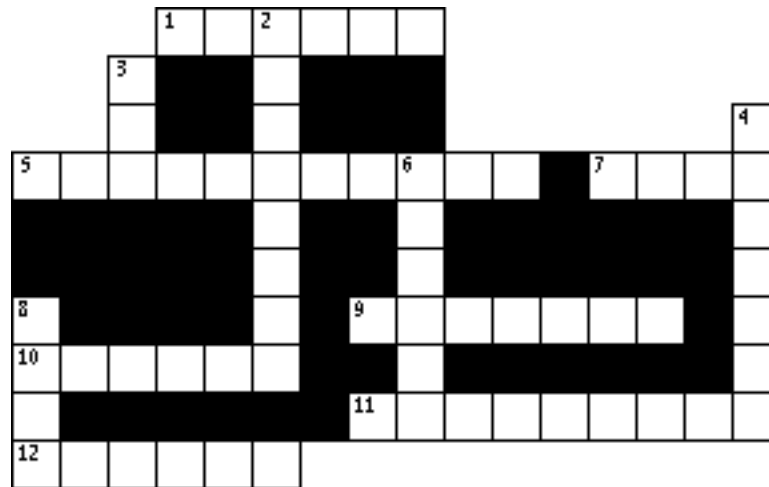

- 3 DOWN "Now the king of Syria was making _____ against Israel; and he took counsel with his servants, saying, 'My camp will be in such and such a place.'" **2 KINGS 6:8**
- 4 DOWN "And the man of God sent to the king of Israel, saying, 'Beware that you do not pass this place, for the _____ are coming down there.'" **2 KINGS 6:9**
- 6 DOWN "Then the king of _____ sent someone to the place of which the man of God had told him." **2 KINGS 6:10**
- 2 DOWN "Therefore the heart of the king of Syria was greatly _____ by this thing." **2 KINGS 6:11**
- 12 ACROSS "And one of his servants said, 'None, my lord, O king; but _____, the prophet who is in Israel, tells the king of Israel the words that you speak in your bedroom.'" **2 KINGS 6:12**
- 1 ACROSS "So he said, 'Go and see where he is, that I may send and get him.' And it was told him, saying, 'Surely he is in _____.'" **2 KINGS 6:13**
- 7 ACROSS "Therefore he sent horses and chariots and a great _____ there, and they came by night and surrounded the city." **2 KINGS 6:14**
- 5 ACROSS "And when the servant of the man of God arose early and went out, there was an army, _____ the city with horses and chariots." **2 KINGS 6:15**
- 8 DOWN "So he answered, 'Do not fear, for those who are with us are _____ than those who are with them.'" **2 KINGS 6:16**
- 10 ACROSS "And Elisha prayed, and said, 'LORD, I pray, open his eyes that he may see.' Then the LORD _____ the eyes of the young man, and he saw." **2 KINGS 6:17**
- 11 ACROSS "So when the Syrians came down to him,, Elisha prayed to the LORD, and said, 'Strike this people, I pray, with _____.'" **2 KINGS 6:18**
- 9 ACROSS "Now Elisha said to them, 'This is not the way, nor is this the city. Follow me, and I will bring you to the man whom you seek.' But he led them to _____." **2 KINGS 6:19**

Bible Story 111

**THE SHUNAMMITE
WOMAN'S
LAND RESTORED**

2 KINGS 8:1-6

111. THE SHUNAMMITE WOMAN'S LAND IS RESTORED

(2 KINGS 8:1-6)



"Restore all that was hers, and all the proceeds of the field from the day that she left the land until now."

2 KINGS 8:6

111. THE SHUNAMMITE WOMAN'S LAND IS RESTORED (2 KINGS 8:1-6)

MEMORY VERSE:

"Restore all that was hers, and all the proceeds of the field from the day that she left the land until now." 2 KINGS 8:6

TRUE OR FALSE:

1. "Then Elisha spoke to the woman whose son had been restored to life." **2 KINGS 8:1**
TRUE OR FALSE

CIRCLE THE CORRECT WORDS:

2. He said to her, "Arise and go, you and your household, and sojourn wherever you can sojourn; for the LORD has called for a (**STORM, FAMINE**), and furthermore, it will come upon the land for seven years." **2 KINGS 8:1**
3. "It came to pass, at the end of seven years, that the woman (**RETURNED, RAN**) from the land of the Philistines; and she went to make an appeal to the king for her house and for her land."
2 KINGS 8:3

FILL IN THE BLANK:

4. "Then the king talked with _____, the servant of the man of God, saying, 'Tell me, please, all the great things Elisha has done.'" **2 KINGS 8:4**

CIRCLE THE CORRECT WORDS:

5. "Now it happened, as he was telling the king how he had restored the dead to life, that there was the woman whose son he had restored to life, appealing to the king for her (**MOUSE, HOUSE**) and for her (**LAND, SAND**)." **2 KINGS 8:5**

TRUE OR FALSE:

6. "The king appointed a certain officer for her." **2 KINGS 8:6**
TRUE OR FALSE
7. He said, "Restore all that was hers, and all the proceeds of the field from the day that she left the land until now." **2 KINGS 8:6**
TRUE OR FALSE

111. THE SHUNAMMITE WOMAN'S LAND IS RESTORED

(2 KINGS 8:1-6)

F G R R W O M A N S
 A E K E U S E M E Z
 M H I T S P S V W P
 I A N U K T E L U Z
 N Z G R J N O O U R
 E I V N Y Z G R Y F
 A P P E A L E D E P
 P B A D W Z Y L O D
 N R E L I S H A L T
 S I G L A N D F P S

APPEALED
 ELISHA
 FAMINE
 GEHAZI

KING
 LAND
 RESTORED

RETURNED
 SEVEN YEARS
 WOMAN

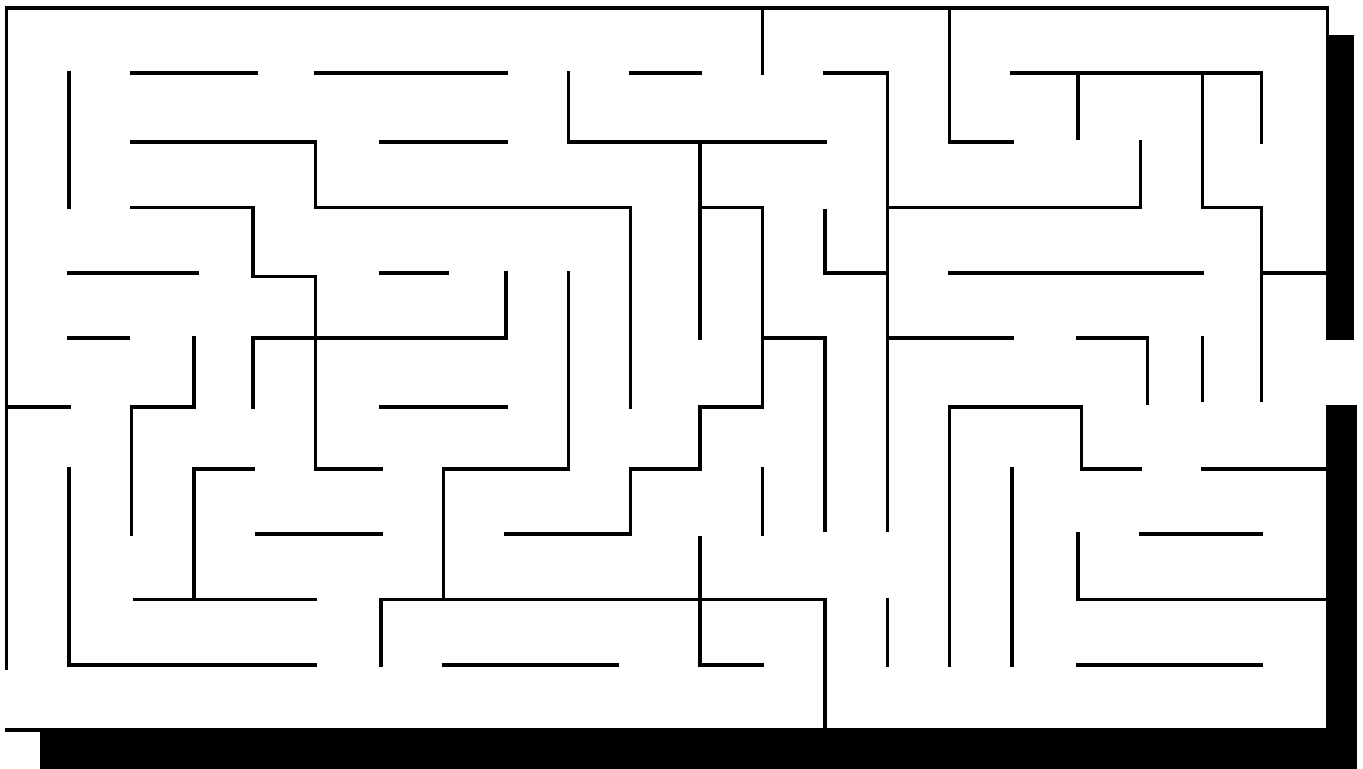

111. THE SHUNAMMITE WOMAN'S LAND IS RESTORED (2 KINGS 8:1-6)

MEMORY VERSE:

"Restore all that was hers, and all the proceeds of the field from the day that she left the land until now." 2 KINGS 8:6

TRUE OR FALSE:

1. "Then Elisha spoke to the woman whose son had been restored to life." **2 KINGS 8:1**
TRUE OR FALSE

FILL IN THE BLANKS:

2. He said to her, "Arise and go, you and your household, and sojourn wherever you can sojourn; for the LORD has called for a _____, and furthermore, it will come upon the land for seven years." **2 KINGS 8:1**
3. "It came to pass, at the end of seven years, that the woman _____ from the land of the Philistines; and she went to make an appeal to the king for her house and for her land."
2 KINGS 8:3
4. "Then the king talked with _____, the servant of the man of God, saying, 'Tell me, please, all the great things Elisha has done.' " **2 KINGS 8:4**
5. "Now it happened, as he was telling the king how he had restored the dead to life, that there was the woman whose son he had restored to life, appealing to the king for her _____ and for her _____." **2 KINGS 8:5**

TRUE OR FALSE:

6. "The king appointed a certain officer for her." **2 KINGS 8:6**
TRUE OR FALSE
7. He said, "Restore all that was hers, and all the proceeds of the field from the day that she left the land until now." **2 KINGS 8:6**
TRUE OR FALSE

111. THE SHUNAMMITE WOMAN'S LAND IS RESTORED

(2 KINGS 8:1-6)

P C U D B E N U R C U O D J B
 Z S D V L L G R I V L L I L H
 S L F I N L I J Y G Y X P L C
 M S S V D S C Z S W L Q M A O
 B H H D E E R F Y H H R W G Y
 A N G K R N N A E N I M A F M
 K I N G O L N R E S U O H H E
 A P U N T A E J U Y M K L G O
 K M Q S S Z P G D T N D G N J
 I N J H E S E P Y H E E S W S
 Y Q V P R H D N E B K R V B Z
 T Q Q P A V A N B A K F Z E N
 F H D Z G M B F A N L H R W S
 Z V I R O M P E O L M E O B W
 B Z D W B O U O J B D L D V I

APPEALED
 ELISHA
 FAMINE
 GEHAZI

HOUSE
 KING
 LAND
 RESTORED

RETURNED
 SEVEN YEARS
 WOMAN

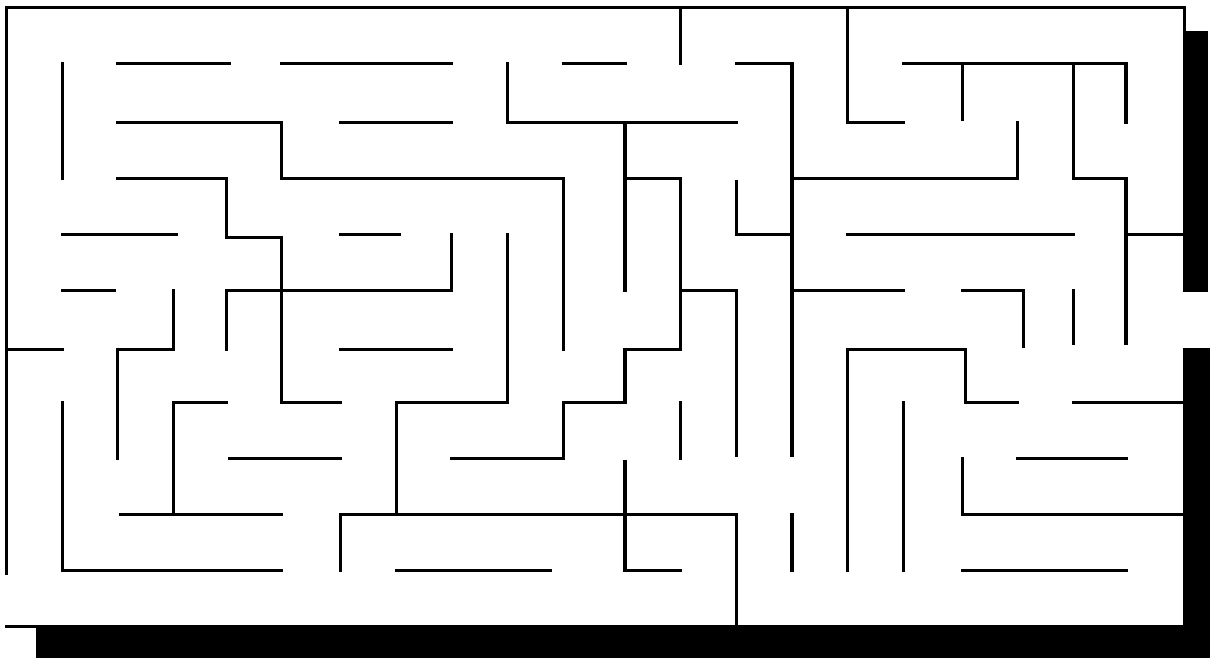

111. THE SHUNAMMITE WOMAN'S LAND IS RESTORED

(2 KINGS 8:1-6)

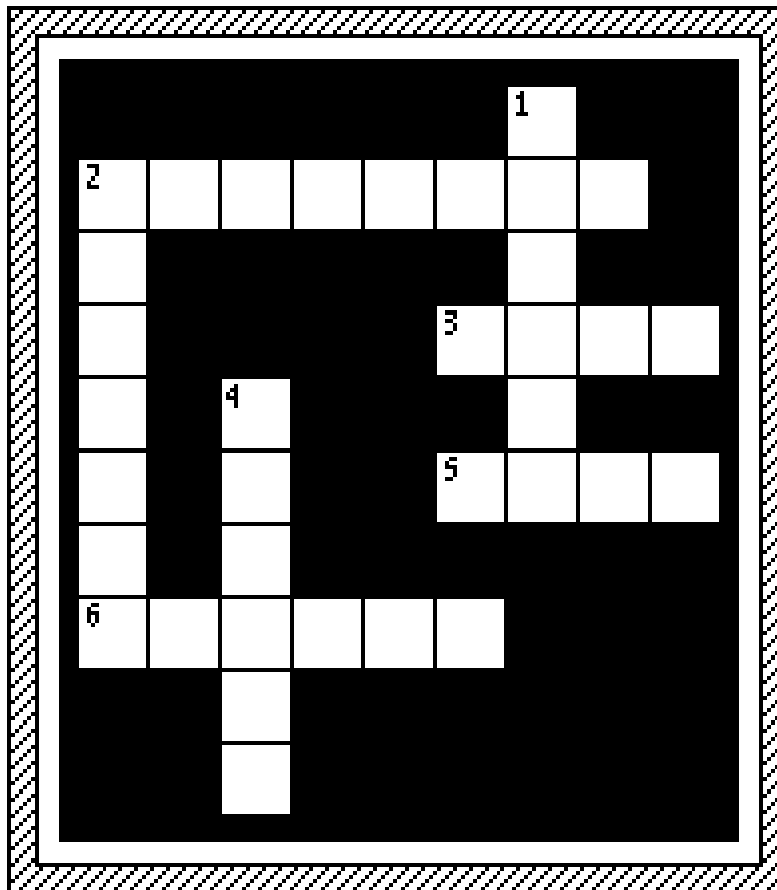

- 6 ACROSS "Then _____ spoke to the woman whose son had been restored to life." **2 KINGS 8:1**
- 4 DOWN He said to her, "Arise and go, you and your household, and sojourn wherever you can sojourn; for the LORD has called for a _____, and furthermore, it will come upon the land for seven years." **2 KINGS 8:1**
- 2 ACROSS "It came to pass, at the end of seven years, that the woman _____ from the land of the Philistines; and she went to make an appeal to the king for her house and for her land." **2 KINGS 8:3**
- 1 DOWN "Then the king talked with _____, the servant of the man of God, saying, 'Tell me, please, all the great things Elisha has done.'" **2 KINGS 8:4**
- 3 ACROSS "Now it happened, as he was telling the king how he had restored the dead to life, that there was the woman whose son he had restored to life, appealing to the king for her house and for her _____." **2 KINGS 8:5**
- 5 ACROSS "The _____ appointed a certain officer for her." **2 KINGS 8:6**
- 2 DOWN He said, "_____ all that was hers, and all the proceeds of the field from the day that she left the land until now." **2 KINGS 8:6**

Bible Story 112

**JOASH REPAIRS
THE TEMPLE**

2 KINGS 12:1-19

112. JOASH REPAIRS THE TEMPLE

(2 KINGS 12:1-19)



"And they gave the money, being told, into the hands of them that did the work, that had the oversight of the house of the LORD: and they laid it out to the carpenters and builders, that wrought upon the house of the LORD;"

2 KINGS 12:11

112. JOASH REPAIRS THE TEMPLE

(2 KINGS 12:1-19)

MEMORY VERSE:

"Jehoash did what was right in the sight of the LORD all the days in which Jehoiada the priest instructed him." 2 KINGS 12:2

CIRCLE THE CORRECT WORDS:

1. "In the seventh year of Jehu, Jehoash became (**KING, OLD**), and he reigned forty years in Jerusalem." 2 KINGS 12:1
2. "Jehoash did what was (**RIGHT, EVIL**) in the sight of the LORD all the days in which Jehoiada the priest instructed him." 2 KINGS 12:2

TRUE OR FALSE:

3. "Now it was so, by the twenty-third year of King Jehoash, that the priests had not repaired the damages of the temple." 2 KINGS 12:6
TRUE OR FALSE
4. "So King Jehoash called Jehoiada the priest and the other priests, and said to them,, 'Why have you not repaired the damages of the temple?' " 2 KINGS 12:7
TRUE OR FALSE

CIRCLE THE CORRECT WORDS:

5. "Then Jehoiada the priest took a (**NEST, CHEST**), bored a hole in its lid, and set it beside the altar, on the right side as one comes into the house of the LORD." 2 KINGS 12:9
6. "And the priests who kept the door put there all the (**MONEY, HONEY**) that was brought into the house of the LORD." 2 KINGS 12:9

FILL IN THE BLANKS:

7. "So it was, whenever they saw that there was much money in the chest, that the king's _____ and the high _____ came up and put it in bags, and counted the money that was found in the house of the LORD." 2 KINGS 12:10

TRUE OR FALSE:

8. "Then they gave the money, which had been apportioned, into the hands of those who did the work, who had oversight of the house of the LORD." 2 KINGS 12:11
TRUE OR FALSE
9. "And they paid it out to the carpenters and builders who worked on the house of the LORD, and to masons and stonecutters, and for buying timber and hewn stone, to repair the damage of the house of the LORD." 2 KINGS 12:11-12
TRUE OR FALSE

112. JOASH REPAIRS THE TEMPLE

(2 KINGS 12:1-19)

P K E T E M P L E W Q D J C C
Z S Z P Q J P R I E S T S A D
S Y P K F V S S I C M I R M I
T M E R R C R V H Y H P S V V
V F U E R E M E M J E R T D E
G L V I D A S E E N I C O I M
W K B L S T M H T A M P N M N
D E I O C H O E P U G L E O Y
K U N N G A R E W O R K C O E
B S M A S S R Z Q K Q O U G N
A I I H A D A I O H E J T N O
G Q U I O Y M U B Y W P T I M
S S H D A M A G E S G D E K B
A S I P W G U U V H M Q R M A
U O L E A Z A H B F W J S U S

BUILDERS

JEHOIADA

REPAIR

CARPENTERS

KING

SCRIBE

CHEST

MASONS

STONECUTTERS

DAMAGES

MONEY

TEMPLE

HAZAEI

PRIESTS

WORK

JEHOASH

112. JOASH REPAIRS THE TEMPLE

(2 KINGS 12:1-19)

MEMORY VERSE:

"Jehoash did what was right in the sight of the LORD all the days in which Jehoiada the priest instructed him." 2 KINGS 12:2

FILL IN THE BLANKS:

1. "In the seventh year of Jehu, Jehoash became _____, and he reigned forty years in Jerusalem." **2 KINGS 12:1**
2. "Jehoash did what was _____ in the sight of the LORD all the days in which Jehoiada the priest instructed him." **2 KINGS 12:2**

TRUE OR FALSE:

3. "Now it was so, by the twenty-third year of King Jehoash, that the priests had not repaired the damages of the temple." **2 KINGS 12:6**
TRUE OR FALSE
4. "So King Jehoash called Jehoiada the priest and the other priests, and said to them,, 'Why have you not repaired the damages of the temple?' " **2 KINGS 12:7**
TRUE OR FALSE

FILL IN THE BLANKS:

5. "Then Jehoiada the priest took a _____, bored a hole in its lid, and set it beside the altar, on the right side as one comes into the house of the LORD." **2 KINGS 12:9**
6. "And the priests who kept the door put there all the _____ that was brought into the house of the LORD." **2 KINGS 12:9**
7. "So it was, whenever they saw that there was much money in the chest, that the king's _____ and the high _____ came up and put it in bags, and counted the money that was found in the house of the LORD." **2 KINGS 12:10**

TRUE OR FALSE:

8. "Then they gave the money, which had been apportioned, into the hands of those who did the work, who had oversight of the house of the LORD." **2 KINGS 12:11**
TRUE OR FALSE
9. "And they paid it out to the carpenters and builders who worked on the house of the LORD, and to masons and stonecutters, and for buying timber and hewn stone, to repair the damage of the house of the LORD." **2 KINGS 12:11-12**
TRUE OR FALSE

112. JOASH REPAIRS THE TEMPLE

(2 KINGS 12:1-19)

T A T M P Y V E J O H D W S Q V R B O Y
O F U U O C C Z G E A S O R G X Z K S L
R A J O J N D B P J Z T W E T O B S U E
I H Q W Z T E A C L A T T T C B P U B H
A D L E Z G B Y M B E W H T A I M I U R
P W L C U U P O Q A L N Z U B B B I G I
E Y V U C P V B I N G G N C N X U Y O V
R F H C P A G V Y Z T E M E B A L U C L
Z Z S J P B R N R Z M F S N I S S H X T
G W S N E T F P I S P O B O B M E W N R
E G T J O H H D E K R B O T G S E Y T A
C K R O W S O H O N U E M S T U B F D L
J Z O T Q G A A I Q T R D I A Z I Y H J
X T L H N X O M S M R E C L H O R P Y K
P T S H B G C Q T H P N R M I B C R J S
D E L P M E T B E M T S A S Q U S I T V
J J T L J E H O I A D A C Q Q H B E G H
P G R Z Q A G K H P Y A B N Y W U S P W
D A X R C L S Q I G W G L U C C Y T M S
Q Z Z L J L M I X D Y U N N L E P S R G

BUILDERS

JEHOIADA

REPAIR

CARPENTERS

KING

SCRIBE

CHEST

MASONS

STONECUTTERS

DAMAGES

MONEY

TEMPLE

HAZAEI

PRIESTS

WORK

JEHOASH

112. JOASH REPAIRS THE TEMPLE

(2 KINGS 12:1-19)

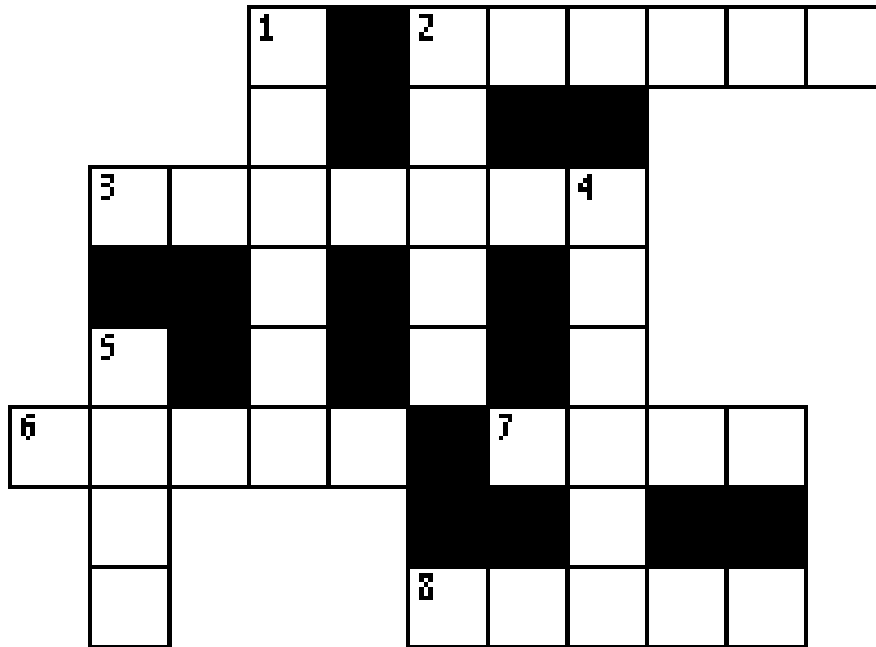

- 7 ACROSS "In the seventh year of Jehu, Jehoash became _____, and he reigned forty years in Jerusalem."
2 KINGS 12:1
- 2 DOWN "Jehoash did what was _____ in the sight of the LORD all the days in which Jehoiada the priest instructed him."
2 KINGS 12:2
- 1 DOWN "Now it was so, by the twenty-third year of King Jehoash, that the priests had not repaired the damages of the _____."
2 KINGS 12:6
- 3 ACROSS "So King Jehoash called Jehoiada the priest and the other priests, and said to them,, 'Why have you not repaired the _____ of the temple?' "
2 KINGS 12:7
- 8 ACROSS "Then Jehoiada the priest took a _____, bored a hole in its lid, and set it beside the altar, on the right side as one comes into the house of the LORD."
2 KINGS 12:9
- 6 ACROSS "And the priests who kept the door put there all the _____ that was brought into the house of the LORD."
2 KINGS 12:9
- 4 DOWN "So it was, whenever they saw that there was much money in the chest, that the king's _____ and the high priest came up and put it in bags, and counted the money that was found in the house of the LORD."
2 KINGS 12:10
- 5 DOWN "Then they gave the money, which had been apportioned, into the hands of those who did the _____, who had oversight of the house of the LORD."
2 KINGS 12:11
- 2 ACROSS "And they paid it out to the carpenters and builders who worked on the house of the LORD, and to masons and stonecutters, and for buying timber and hewn stone, to _____ the damage of the house of the LORD."
2 KINGS 12:11-12

Bible Story 113

**HEZEKIAH
CLEANSES
THE TEMPLE**

2 CHRONICLES 29:3-19

113. HEZEKIAH CLEANSSES THE TEMPLE

(2 CHRONICLES 29:3-19)

"... sanctify now yourselves,
and sanctify the house of the Lord
God of your fathers, and carry forth the
filthiness out of holy place."

2 CHRONICLES 29:5



113. HEZEKIAH CLEANSSES THE TEMPLE

(2 CHRONICLES 29:3-19)

MEMORY VERSE:

"My sons, do not be negligent now, for the LORD has chosen you to stand before Him, to serve Him, and that you should minister to Him and burn incense." 2 CHRONICLES 29:11

TRUE OR FALSE:

1. "In the first year of his reign, in the first month, he opened the doors of the house of the LORD and repaired them." **2 CHRONICLES 29:3**

TRUE OR FALSE

CIRCLE THE CORRECT WORD:

2. "Then he brought in the priests and the Levites, and gathered them in the East Square, and said to them: 'Hear me, Levites! Now sanctify yourselves, sanctify the house of the LORD God of your fathers, and carry out the (RUBBISH, RUBBLE) from the holy place.' " **2 CHRONICLES 29:4-5**

TRUE OR FALSE:

3. He said, "For our fathers have trespassed and done evil in the eyes of the LORD our God; they have forsaken Him, have turned their faces away from the habitation of the LORD, and turned their backs on Him." **2 CHRONICLES 29:6**

TRUE OR FALSE

4. "They have also shut up the doors of the vestibule, put out the lamps, and have not burned incense or offered burnt offerings in the holy place to the God of Israel." **2 CHRONICLES 29:7**

TRUE OR FALSE

CIRCLE THE CORRECT WORDS:

5. "Therefore the (BLESSINGS, WRATH) of the LORD fell upon Judah and Jerusalem." **2 CHRONICLES 29:8**
6. Hezekiah said, "Now it is in my (HEAD, HEART) to make a covenant with the LORD God of Israel, that His fierce wrath may turn away from us." **2 CHRONICLES 29:10**

FILL IN THE BLANKS:

7. "My sons, do not be negligent now, for the _____ has chosen you to stand before Him, to serve Him, and that you should minister to Him and burn incense." **2 CHRONICLES 29:11**

CIRCLE THE CORRECT WORD:

8. "And they gathered their brethren, sanctified themselves, and went according to the commandment of the king, at the words of the LORD, to (CLEANSE, BUILD) the house of the LORD." **2 CHRON 29:15**

TRUE OR FALSE:

9. "Then the priests went in to the inner part of the house of the LORD to cleanse it, and brought out all the debris that they found in the temple of the LORD to the court of the house of the LORD." **2 CHRONICLES 29:16**

TRUE OR FALSE

10. And the Levites left all the debris in the court of the house of the LORD. **2 CHRONICLES 29:16**

TRUE OR FALSE

11. "Then they sanctified the house of the LORD in eight days, and on the sixteenth day of the first month they finished." **2 CHRONICLES 29:17**

TRUE OR FALSE

113. HEZEKIAH CLEANSSES THE TEMPLE

(2 CHRONICLES 29:3-19)

H E Z E K I A H S S
C J J M U G N E A P
O R C O N V T N N R
V E X I D I C W E I
E P K O V T R L L E
N A V E I A O P P S
A I L F T R B W M T
N R I H D E A J E S
T E D H S I B B T R
D D C L E A N S E L

COVENANT

LORD

RUBBISH

HEZEKIAH

PRIESTS

SANCTIFIED

KING

REPAIRED

WRATH

LEVITES

CLEANSE

TEMPLE

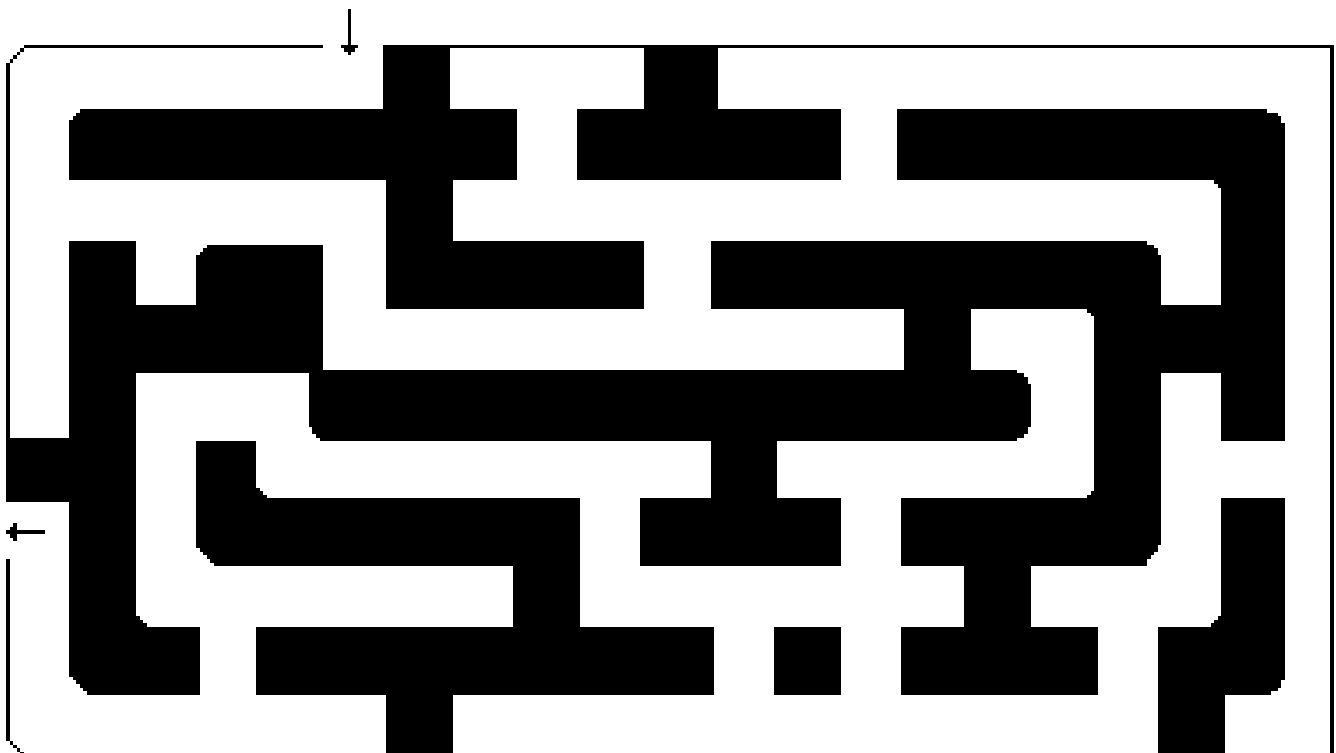

113. HEZEKIAH CLEANSSES THE TEMPLE

(2 CHRONICLES 29:3-19)

MEMORY VERSE:

"My sons, do not be negligent now, for the LORD has chosen you to stand before Him, to serve Him, and that you should minister to Him and burn incense." 2 CHRONICLES 29:11

TRUE OR FALSE:

1. "In the first year of his reign, in the first month, he opened the doors of the house of the LORD and repaired them." 2 CHRONICLES 29:3

TRUE OR FALSE

FILL IN THE BLANK:

2. "Then he brought in the priests and the Levites, and gathered them in the East Square, and said to them: 'Hear me, Levites! Now sanctify yourselves, sanctify the house of the LORD God of your fathers, and carry out the _____ from the holy place.'" 2 CHRONICLES 29:4-5

TRUE OR FALSE:

3. He said, "For our fathers have trespassed and done evil in the eyes of the LORD our God; they have forsaken Him, have turned their faces away from the habitation of the LORD, and turned their backs on Him." 2 CHRONICLES 29:6

TRUE OR FALSE

4. "They have also shut up the doors of the vestibule, put out the lamps, and have not burned incense or offered burnt offerings in the holy place to the God of Israel." 2 CHRONICLES 29:7

TRUE OR FALSE

FILL IN THE BLANKS:

5. "Therefore the _____ of the LORD fell upon Judah and Jerusalem." 2 CHRONICLES 29:8
6. Hezekiah said, "Now it is in my _____ to make a covenant with the LORD God of Israel, that His fierce wrath may turn away from us." 2 CHRONICLES 29:10
7. "My sons, do not be negligent now, for the _____ has chosen you to stand before Him, to serve Him, and that you should minister to Him and burn incense." 2 CHRONICLES 29:11
8. "And they gathered their brethren, sanctified themselves, and went according to the commandment of the king, at the words of the LORD, to _____ the house of the LORD." 2 CHRONICLES 29:15

TRUE OR FALSE:

9. "Then the priests went in to the inner part of the house of the LORD to cleanse it, and brought out all the debris that they found in the temple of the LORD to the court of the house of the LORD." 2 CHRONICLES 29:16

TRUE OR FALSE

10. And the Levites left all the debris in the court of the house of the LORD. 2 CHRONICLES 29:16

TRUE OR FALSE

11. "Then they sanctified the house of the LORD in eight days, and on the sixteenth day of the first month they finished." 2 CHRONICLES 29:17

TRUE OR FALSE

113. HEZEKIAH CLEANSSES THE TEMPLE

(2 CHRONICLES 29:3-19)

I E T N E M D N A M M O C M C
M Q S F R A R T K G Y Y H T O
J T T G R U B K N V Z A Q Q G Z
C T W G K Y I D G A I B Q J D
W C D A U E R F E K N P F O O
G L E Z P U D Q E R R E E X O
G E I I B D A Z C S I B V F R
V A F B S K E N E E Q A G O S
B N I N Q H M T B A V N P O C
I S T T V J I I B B I N Z E M
H E C S Y V D G V K E Y H F R
F B N Y E Y I J T E M P L E J
D G A L E S T S E I R P F V A
L S S T L L R L W R A T H E P
Y I J G P Y G D K D R O L H N

CLEANSE
COMMANDMENT
COVENANT
DOORS
HEZEKIAH

KING
LEVITES
LORD
PRIESTS
REPAIRED

RUBBISH
SANCTIFIED
TEMPLE
WRATH

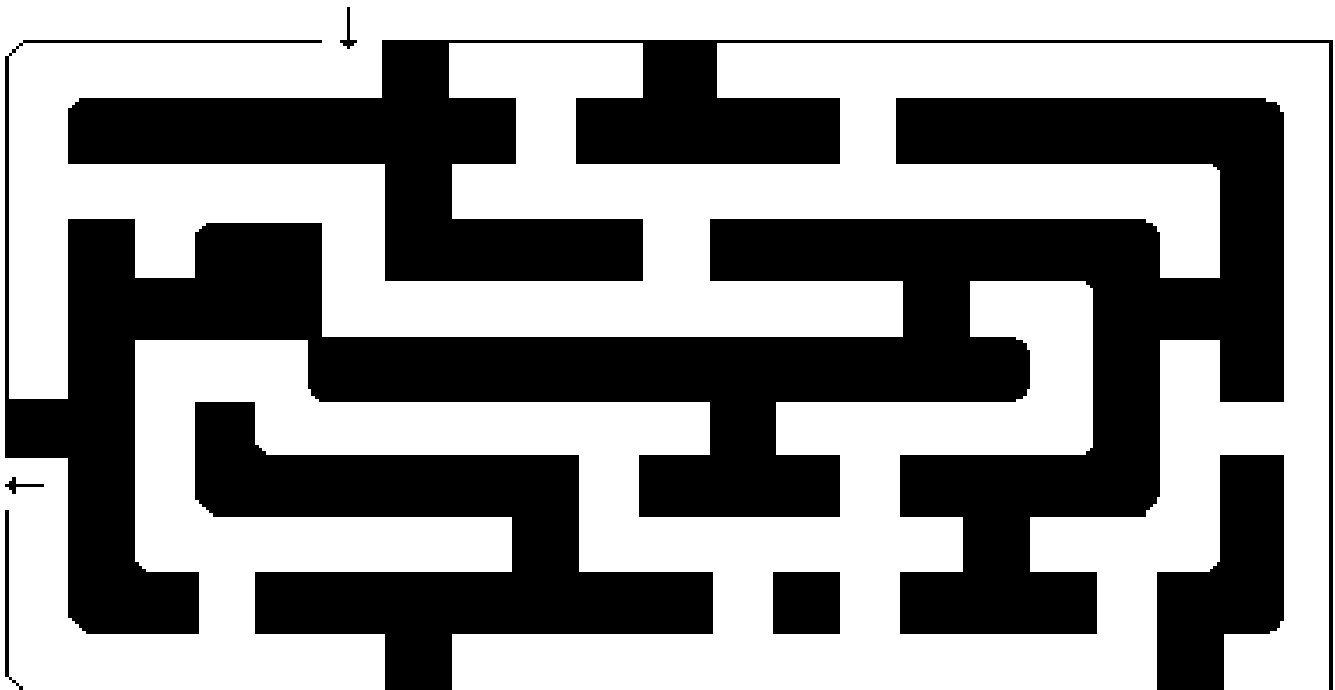

113. HEZEKIAH CLEANSSES THE TEMPLE

(2 CHRONICLES 29:3-19)

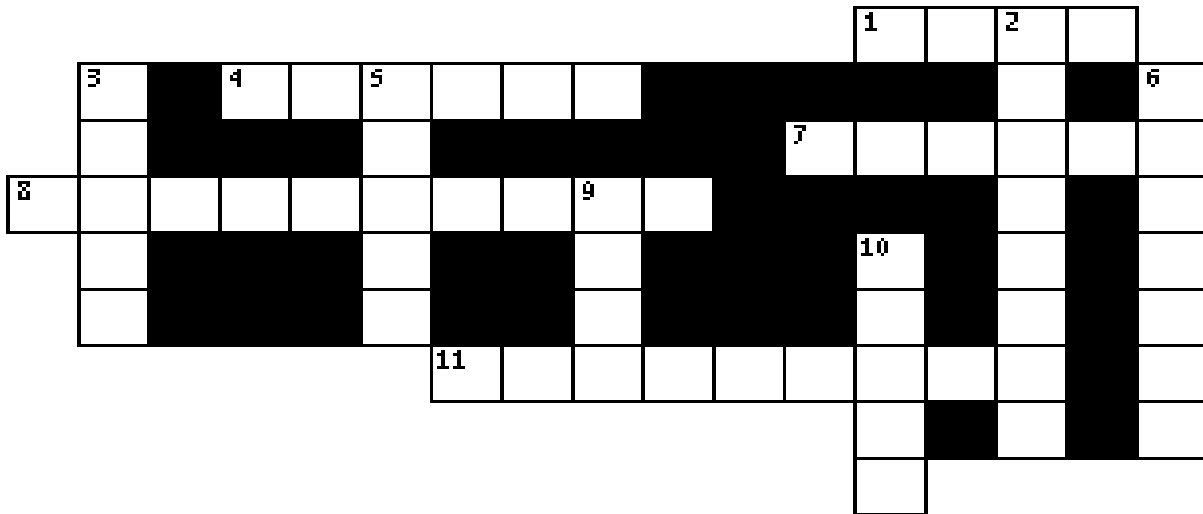

- 2 DOWN "In the first year of his reign, in the first month, he opened the doors of the house of the LORD and _____ them." **2 CHRONICLES 29:3**
- 4 ACROSS "Then he brought in the priests and the Levites, and gathered them in the East Square, and said to them: 'Hear me, Levites! Now sanctify yourselves, sanctify the house of the LORD God of your fathers, and carry out the _____ from the holy place.'" **2 CHRONICLES 29:4-5**
- 9 DOWN He said, "For our fathers have trespassed and done _____ in the eyes of the LORD our God; they have forsaken Him, have turned their faces away from the habitation of the LORD, and turned their backs on Him." **2 CHRONICLES 29:6**
- 11 ACROSS "They have also shut up the doors of the vestibule, put out the lamps, and have not burned incense or offered burnt offerings in the _____ to the God of Israel." **2 CHRONICLES 29:7**
- 3 DOWN "Therefore the _____ of the LORD fell upon Judah and Jerusalem." **2 CHRONICLES 29:8**
- 10 DOWN Hezekiah said, "Now it is in my _____ to make a covenant with the LORD God of Israel, that His fierce wrath may turn away from us." **2 CHRONICLES 29:10**
- 1 ACROSS "My sons, do not be negligent now, for the _____ has chosen you to stand before Him, to serve Him, and that you should minister to Him and burn incense." **2 CHRONICLES 29:11**
- 5 DOWN "And they gathered their brethren, sanctified themselves, and went according to the commandment of the king, at the words of the LORD, to _____ the house of the LORD." **2 CHRONICLES 29:15**
- 7 ACROSS "Then the priests went in to the inner part of the house of the LORD to cleanse it, and brought out all the debris that they found in the _____ of the LORD to the court of the house of the LORD." **2 CHRONICLES 29:16**
- 6 DOWN "And the _____ took it out and carried it to the Brook Kidron." **2 CHRONICLES 29:16**
- 8 ACROSS "Then they _____ the house of the LORD in eight days, and on the sixteenth day of the first month they finished." **2 CHRONICLES 29:17**

Bible Story 114

**HEZEKIAH
RESTORES
TEMPLE WORSHIP**

2 CHRONICLES 29:20-36

114. HEZEKIAH RESTORES TEMPLE WORSHIP (2 CHRONICLES 29:20-36)



"And Hezekiah commanded to offer the burnt offering upon the altar.
And when the burnt offering began, the song of the LORD began *also*
with the trumpets, and with the instruments *ordained* by David king of Israel."

2 CHRONICLES 29:27

"And the consecrated things *were* six hundred oxen and three thousand sheep." **2 CHRONICLES 29:33**

114. HEZEKIAH RESTORES TEMPLE WORSHIP

(2 CHRONICLES 29:20-36)

MEMORY VERSE:

"And when they had finished offering, the king and all who were present with him bowed and worshiped." 2 CHRONICLES 29:29

TRUE OR FALSE:

1. "King Hezekiah rose early, gathered the rulers of the city, and went up to the house of the LORD." 2 CHRONICLES 29:20

TRUE OR FALSE

2. "Then he commanded the priests, the sons of Aaron, to offer them on the altar of the LORD." 2 CHRONICLES 29:21

TRUE OR FALSE

CIRCLE THE CORRECT WORDS:

3. "Then he stationed the Levites in the house of the LORD with (THIMBLES, CYMBALS), with (BROKEN, STRINGED) instruments, and with (HARPS, TARPS)." 2 CHRONICLES 29:25

TRUE OR FALSE:

4. The Levites stood with the instruments of David and with the trumpets. 2 CHRONICLES 29:26

TRUE OR FALSE

CIRCLE THE CORRECT WORDS:

5. "Then Hezekiah commanded them to offer the burnt offering on the altar. And when the burnt offering began, the (WORD, SONG) of the LORD also began, with the trumpets and with the instruments of David king of Israel." 2 CHRONICLES 29:27

MATCHING:

DRAW A LINE CONNECTING THE PEOPLE ON THE LEFT WITH THEIR FORM OF WORSHIP ON THE RIGHT

6. "So..." 2 CHRONICLES 29:28

ALL THE CONGREGATION
THE SINGERS
THE TRUMPETERS

SOUNDED
WORSHIPED
SANG

TRUE OR FALSE:

7. "And when they had finished offering, the king and all who were present with him bowed and worshiped." 2 CHRONICLES 29:29

TRUE OR FALSE

CIRCLE THE CORRECT WORDS:

8. "Moreover King Hezekiah and the leaders commanded the Levites to sing praise to the LORD with the words of (DAVID, JOSEPH) and of (ASA, ASAPH) the seer." 2 CHRONICLES 29:30

9. "So they sang praises with (GLADNESS, SADNESS), and they bowed their heads and worshiped." 2 CHRONICLES 29:30

10. "Hezekiah and all the people (REJOICED, WEPT) that God had prepared the people, since the events took place so suddenly." 2 CHRONICLES 29:36

114. HEZEKIAH RESTORES TEMPLE WORSHIP

(2 CHRONICLES 29:20-36)

W O R S H I P D D M J W I F G
S W N Y S R Q W Y G Y I B O H
V H U C O T N T S O K H R E N
Y C A H O D N G L A D N E S S
K Y D I I N I E M V P J W P V
W M L M K G G L M S G D G J S
S B U L R E S R U U M U T J U
T A E S E B Z G E P R O T F G
S L L T F V S E N G G T W Y N
E S P E Y E I A H I A L S T O
I Z M P H H V T R T R T I N S
R O E M A T U O E W P E I W I
P A T U R L U A S S S O F O P
L B F R P U A P E B O U U F N
W U L T S W D A J H T I M U O

CONGREGATION
CYMBALS
GLADNESS
HARPS
HEZEKIAH

INSTRUMENTS
LEVITES
OFFERINGS
PRIESTS

SONG
TEMPLE
TRUMPETS
WORSHIP

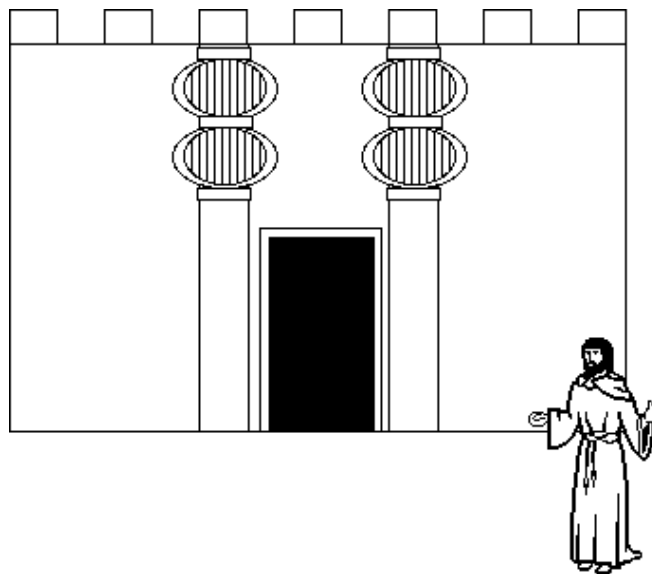

114. HEZEKIAH RESTORES TEMPLE WORSHIP

(2 CHRONICLES 29:20-36)

MEMORY VERSE:

"And when they had finished offering, the king and all who were present with him bowed and worshiped." 2 CHRONICLES 29:29

TRUE OR FALSE:

1. "King Hezekiah rose early, gathered the rulers of the city, and went up to the house of the LORD."
2 CHRONICLES 29:20

TRUE OR FALSE

2. "Then he commanded the priests, the sons of Aaron, to offer them on the altar of the LORD."
2 CHRONICLES 29:21

TRUE OR FALSE

FILL IN THE BLANKS:

3. "Then he stationed the Levites in the house of the LORD with _____, with _____ instruments, and with _____." 2 CHRONICLES 29:25

TRUE OR FALSE:

4. The Levites stood with the instruments of David and with the trumpets. 2 CHRONICLES 29:26

TRUE OR FALSE

FILL IN THE BLANK:

5. "Then Hezekiah commanded them to offer the burnt offering on the altar. And when the burnt offering began, the _____ of the LORD also began, with the trumpets and with the instruments of David king of Israel."
2 CHRONICLES 29:27

MATCHING:

DRAW A LINE CONNECTING THE PEOPLE ON THE LEFT WITH THEIR FORM OF WORSHIP ON THE RIGHT

6. "So..." 2 CHRONICLES 29:28

ALL THE CONGREGATION
THE SINGERS
THE TRUMPETERS

SOUNDED
WORSHIPED
SANG

TRUE OR FALSE:

7. "And when they had finished offering, the king and all who were present with him bowed and worshiped." 2 CHRONICLES 29:29

TRUE OR FALSE

FILL IN THE BLANKS:

8. "Moreover King Hezekiah and the leaders commanded the Levites to sing praise to the LORD with the words of _____ and of _____ the seer." 2 CHRONICLES 29:30

9. "So they sang praises with _____, and they bowed their heads and worshiped."
2 CHRONICLES 29:30

10. "Hezekiah and all the people _____ that God had prepared the people, since the events took place so suddenly." 2 CHRONICLES 29:36

114. HEZEKIAH RESTORES TEMPLE WORSHIP

(2 CHRONICLES 29:20-36)

A C J R Y T P W D O M K O W Q E P K D K
 W H A I K E Z E H F D O J H S P R A H A
 R Q T P Y S J B R L L P S P O V T L J T
 P I E I O G N O S L S R F T E A C W I W
 E T E M P L E M C M V I A J E R S K P L
 S W S G N I R E F F O E H H W P C I T A
 G Z J Q F V H W G S R S A Q W L M J V P
 D K Z D V O G U R Z C T H O O W H U R P
 E K Z J Y J E F G F M S Z A R J U S R A
 L Q K Q S J U I N P L I Y W S U E U F T
 E J C R V E W L G G B T N V H O C E E W
 V N O I T A G E R G N O C M I S N A J V
 I B T I M E S I A R P E J F P S Q V O Q
 T B I L A A D G Z K R J T S E E L D U D
 E R O S Z W W Y J B A K P W B N K Q G V
 S B T T S L Y P P U J K L U K D D E F S
 I N S T R U M E N T S P J D S A D N K M
 P K A F H Z P Y N K W Z C S U L O R D C
 Z E S L A B M Y C C J Y V J H G K Y B Z
 C F N A M X Z B U U U Y T H P E Q Y K L

CONGREGATION
 CYMBALS
 GLADNESS
 HARPS
 HEZEKIAH

INSTRUMENTS
 LEVITES
 OFFERINGS
 PRAISE
 PRIESTS

SONG
 TEMPLE
 TRUMPETS
 WORSHIP

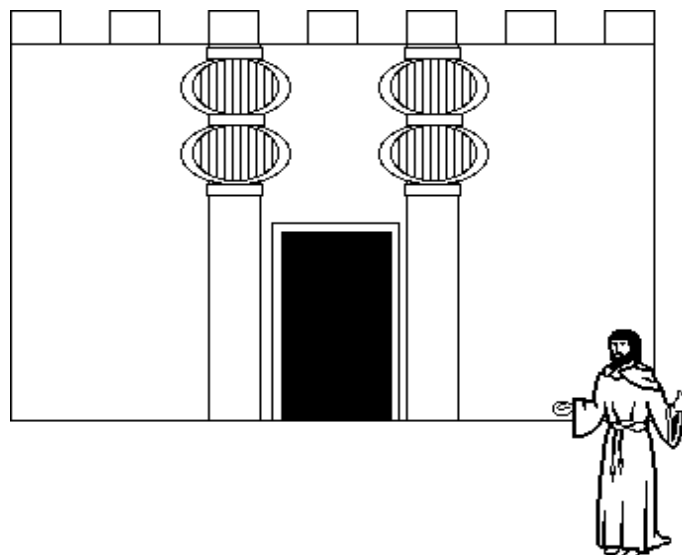

114. HEZEKIAH RESTORES TEMPLE WORSHIP (2 CHRONICLES 29:20-36)

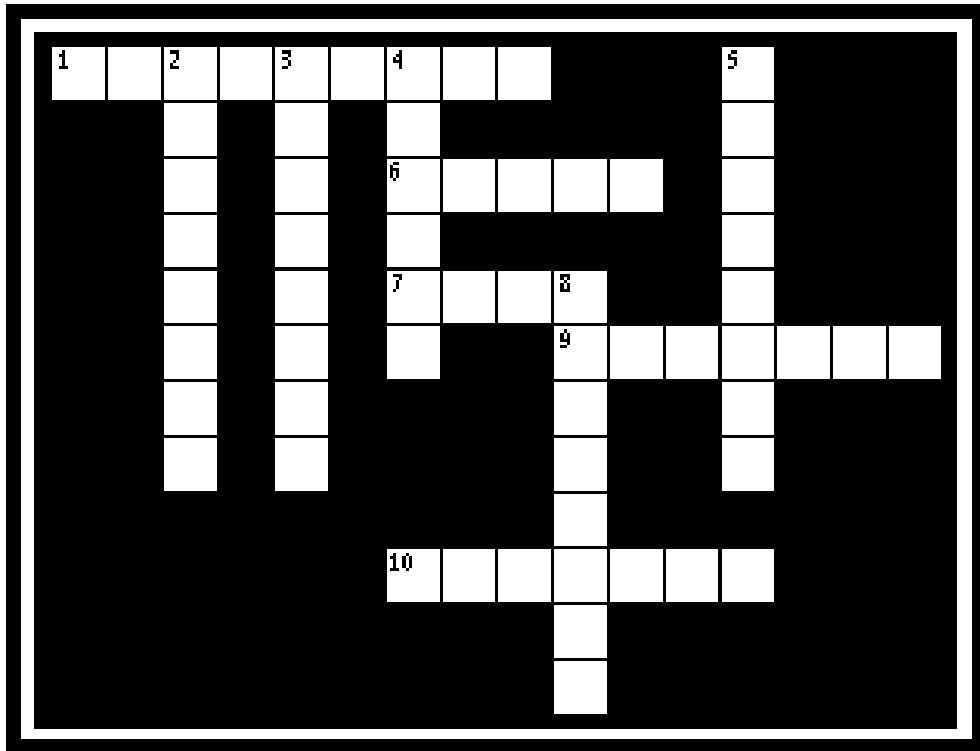

- 3 DOWN "King _____ rose early, gathered the rulers of the city, and went up to the house of the LORD."
2 CHRONICLES 29:20
- 6 ACROSS "Then he commanded the priests, the sons of Aaron, to offer them on the _____ of the LORD."
2 CHRONICLES 29:21
- 9 ACROSS "Then he stationed the _____ in the house of the LORD with cymbals, with stringed instruments, and with harps."
2 CHRONICLES 29:25
- 10 ACROSS "The Levites stood with the instruments of David, and the _____ with the trumpets."
2 CHRONICLES 29:26
- 7 ACROSS "Then Hezekiah commanded them to offer the burnt offering on the altar. And when the burnt offering began, the _____ of the LORD also began, with the trumpets and with the instruments of David king of Israel."
2 CHRONICLES 29:27
- 5 DOWN "So all the congregation worshiped, the singers sang, and the trumpeters sounded; all this continued until the burnt _____ was finished."
2 CHRONICLES 29:28
- 1 ACROSS "And when they had finished offering, the king and all who were present with him bowed and _____."
2 CHRONICLES 29:29
- 4 DOWN "Moreover King Hezekiah and the leaders commanded the Levites to sing _____ to the LORD with the words of David and of Asaph the seer."
2 CHRONICLES 29:30
- 8 DOWN "So they sang praises with _____, and they bowed their heads and worshiped."
2 CHRONICLES 29:30
- 2 DOWN "Hezekiah and all the people _____ that God had prepared the people, since the events took place so suddenly."
2 CHRONICLES 29:36

Bible Story 115

**ISRAEL IS CARRIED
TO ASSYRIA**

2 KINGS 17:5-41

115. ISRAEL IS CARRIED TO ASSYRIA

(2 KINGS 17:5-41)



115. ISRAEL IS CARRIED TO ASSYRIA

(2 KINGS 17:5-41)

MEMORY VERSE:

"But the LORD your God you shall fear; and He will deliver you from the hand of all your enemies." 2 KINGS 17:39

TRUE OR FALSE:

1. "The king of Assyria went throughout all the land, and went up to Samaria and besieged it for three years." **2 KINGS 17:5**
TRUE OR FALSE
2. In the ninth year of Hoshea, the king of Assyria took Samaria and carried Israel away to Egypt.
2 KINGS 17:6
TRUE OR FALSE

CIRCLE THE CORRECT WORDS:

3. "For so it was that the children of Israel had (**CRIED, SINNED**) against the LORD their God, who had brought them up out of the land of Egypt, from under the hand of Pharaoh king of Egypt." **2 KINGS 17:7**
4. "Also the children of Israel (**SECRETLY, OPENLY**) did against the LORD their God things that were not right, and they built for themselves high places in all their cities, from watchtower to fortified city." **2 KINGS 17:9**

TRUE OR FALSE:

5. "They left all the commandments of the LORD their God, made for themselves a molded image and two calves, made a wooden image and worshiped all the host of heaven, and served Baal."
2 KINGS 17:16
TRUE OR FALSE

FILL IN THE BLANK:

6. "Therefore the LORD was very angry with Israel, and removed them from His sight; there was none left but the tribe of _____ alone." **2 KINGS 17:18**

CIRCLE THE CORRECT WORD:

7. "Then the king of Assyria brought (**CHARIOTS, PEOPLE**) from Babylon, Cuthah, Ava, Hamath, and from Sepharvaim, and placed them in the cities of Samaria instead of the children of Israel." **2 KINGS 17:24**

TRUE OR FALSE:

8. "These nations feared the LORD, yet served their carved images." **2 KINGS 17:41**
TRUE OR FALSE

115. ISRAEL IS CARRIED TO ASSYRIA (2 KINGS 17:5-41)

S I N N E D R U A K
 O S D G E F P Z S K
 A Y L T E R C E S Y
 T M T A I K P V Y R
 M R R I M A G E R G
 S E C A L P H G I H
 D A I R A M A S A I
 Z P N K I N G F R K
 W O R S H I P E D U
 J C N D E V R E S A

ASSYRIA	KING	SERVED
FEARED	SAMARIA	SINNED
HIGH PLACES	SECRETLY	WORSHIPED
IMAGE		

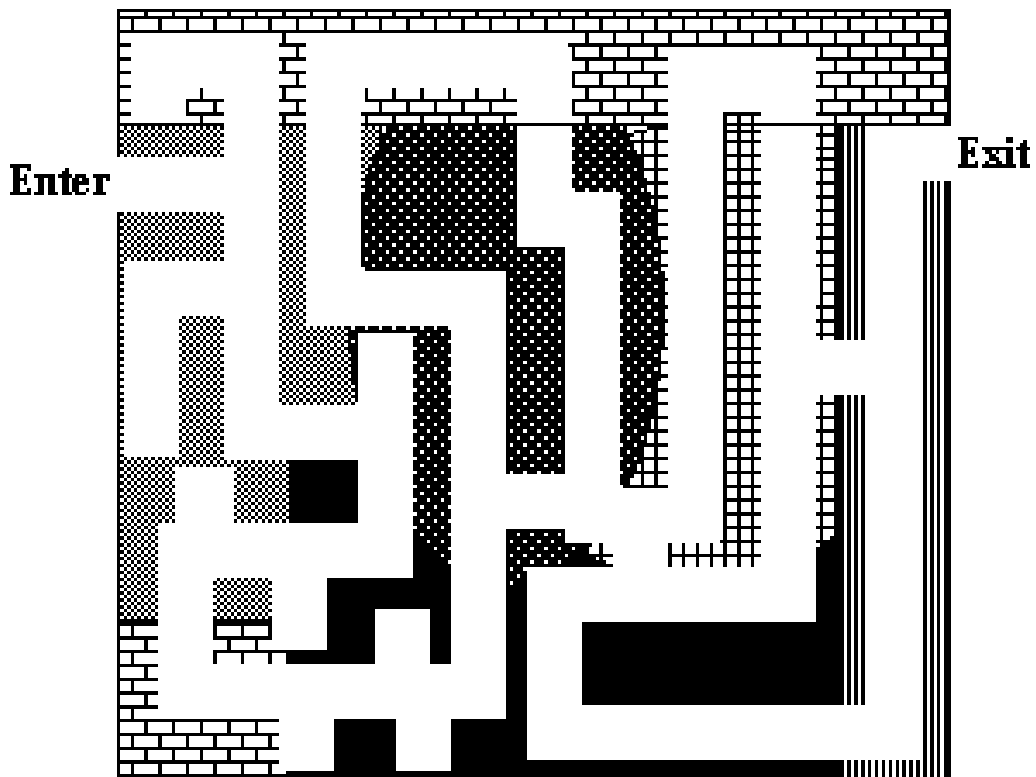

115. ISRAEL IS CARRIED TO ASSYRIA

(2 KINGS 17:5-41)

MEMORY VERSE:

"But the LORD your God you shall fear; and He will deliver you from the hand of all your enemies." 2 KINGS 17:39

TRUE OR FALSE:

1. "The king of Assyria went throughout all the land, and went up to Samaria and besieged it for three years." 2 KINGS 17:5
TRUE OR FALSE
2. In the ninth year of Hoshea, the king of Assyria took Samaria and carried Israel away to Egypt. 2 KINGS 17:6
TRUE OR FALSE

FILL IN THE BLANKS:

3. "For so it was that the children of Israel had _____ against the LORD their God, who had brought them up out of the land of Egypt, from _____ under the hand of Pharaoh king of Egypt." 2 KINGS 17:7
4. "Also the children of Israel _____ did against the LORD their God things that were not right, and they built for themselves high places in all their cities, from watchtower to fortified city." 2 KINGS 17:9

TRUE OR FALSE:

5. "They left all the commandments of the LORD their God, made for themselves a molded image and two calves, made a wooden image and worshiped all the host of heaven, and served Baal." 2 KINGS 17:16
TRUE OR FALSE

FILL IN THE BLANKS:

6. "Therefore the LORD was very angry with Israel, and removed them from His sight; there was none left but the tribe of _____ alone." 2 KINGS 17:18
7. "Then the king of Assyria brought _____ from Babylon, Cuthah, Ava, Hamath, and from Sepharvaim, and placed them in the cities of _____ Samaria instead of the children of Israel." 2 KINGS 17:24

TRUE OR FALSE:

8. "These nations feared the LORD, yet served their carved images." 2 KINGS 17:41
TRUE OR FALSE

115. ISRAEL IS CARRIED TO ASSYRIA (2 KINGS 17:5-41)

U Q V P R I Z G Q G Q O S W T
 R S F B S N N B N W J F P K B
 S S I R C I U A H W I M A G E
 Y D A W K D E P I H S R O W V
 N E U E S U U V M R J U W O D
 L V Y N A E I B G D A D J I E
 Y R L A G S C W Q I C M H L V
 R A T I O V S A W C P I A D R
 G C E P W F I Y L P V V N S E
 N O R Q J E N Y R P D E F S S
 A E C D V A N U L I H M G W Q
 F Z E R H R E K I L A G I J O
 L P S O Y E D Y O O I N I L V
 K E H L G D P H N P M B E H Y
 I U I F M E Q F S D O A G J P

ANGRY
 ASSYRIA
 CARVED
 FEARED
 HIGH PLACES

IMAGE
 ISRAEL
 KING
 LIONS
 LORD

SAMARIA
 SECRETLY
 SERVED
 SINNED
 WORSHIPED

WRITE DOWN THE LETTERS AS YOU COME TO THEM ON THE LINES BELOW

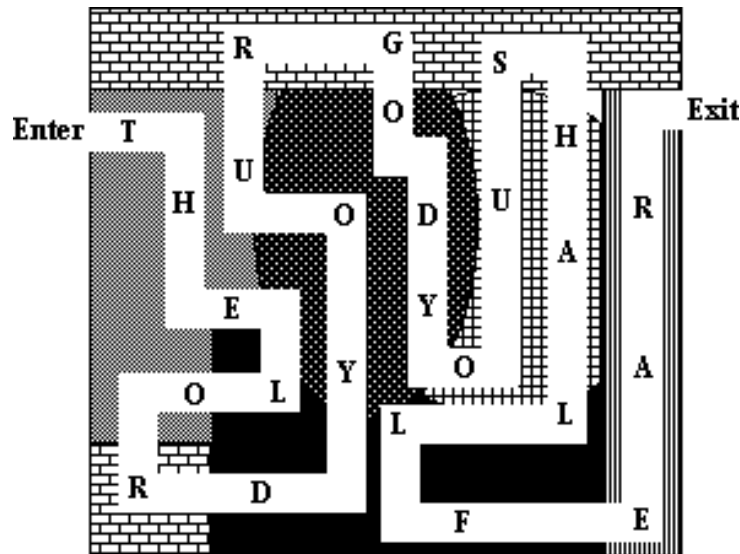

115. ISRAEL IS CARRIED TO ASSYRIA

(2 KINGS 17:5-41)

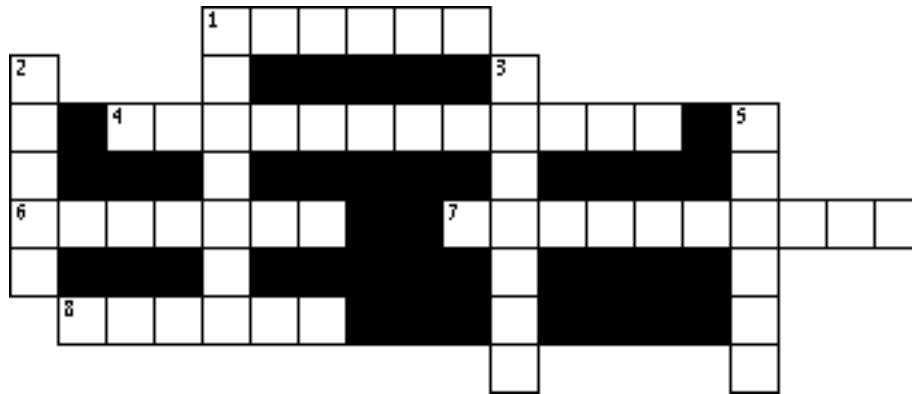

- 6 ACROSS "The king of _____ went throughout all the land, and went up to Samaria and besieged it for three years." **2 KINGS 17:5**
- 8 ACROSS "In the ninth year of Hoshea, the king of Assyria took Samaria and carried _____ away to Assyria." **2 KINGS 17:6**
- 1 ACROSS "For so it was that the children of Israel had _____ against the LORD their God, who had brought them up out of the land of Egypt, from under the hand of Pharaoh king of Egypt." **2 KINGS 17:7**
- 7 ACROSS "Also the children of Israel openly did against the LORD their God things that were not right, and they built for themselves _____ in all their cities, from watchtower to fortified city." **2 KINGS 17:9**
- 4 ACROSS "They left all the _____ of the LORD their God, made for themselves a molded image and two calves, made a wooden image and worshiped all the host of heaven, and served Baal." **2 KINGS 17:16**
- 2 DOWN "Therefore the LORD was very angry with Israel, and removed them from His sight; there was none left but the tribe of _____ alone." **2 KINGS 17:18**
- 1 DOWN "Then the king of Assyria brought people from Babylon, Cuthah, Ava, Hamath, and from Sepharvaim, and placed them in the cities of _____ instead of the children of Israel." **2 KINGS 17:24**
- 3 DOWN "But the LORD your God you shall fear; and He will _____ you from the hand of all your enemies." **2 KINGS 17:39**
- 5 DOWN "These nations _____ the LORD, yet served their carved images." **2 KINGS 17:41**

Bible Story 116

JOSIAH

2 KINGS 22:1-2; 23:1-30

116. JOSIAH
(2 KINGS 22:1-2; 23:1-30)



" And he did *that which was* right in the sight of the LORD, and walked in all the way of David his father, and turned not aside to the right hand or to the left." **2 KINGS 22:2**

116. JOSIAH

(2 KINGS 22:1-2; 23:1-30)

MEMORY VERSE:

"Now before him there was no king like him, who turned to the LORD with all his heart, with all his soul, and with all his might." 2 KINGS 23:25

TRUE OR FALSE:

1. "Josiah was eight years old when he became king, and he reigned thirty-one years in Jerusalem." **2 KINGS 22:1**
TRUE OR FALSE
2. "He did what was right in the sight of the LORD, and walked in all the ways of his father David; he did not turn aside to the right hand or to the left." **2 KINGS 22:2**
TRUE OR FALSE

CIRCLE THE CORRECT WORDS:

3. Josiah "the king went up to the house of the LORD with all the men of Judah, and with him all the inhabitants of Jerusalem- the priests and prophets and all the people, both small and great; and he (**READ, FED**) in their hearing all the words of the Book of the Covenant which had been found in the house of the LORD." **2 KINGS 23:2**
4. "Then the king stood by a pillar, and made a (**CAKE, COVENANT**) before the LORD, to follow the LORD and to keep His commandments and His testimonies and His statutes, with all his heart and all his soul, to perform the words of this covenant that were written in this book." **2 KINGS 23:3**

TRUE OR FALSE:

5. But none of the people took their stand for the covenant. **2 KINGS 23:3**
TRUE OR FALSE
6. "And the king commanded Hilkiah the high priest, the priests of the second order, and the doorkeepers, to bring out of the temple of the LORD all the articles that were made for Baal, for Asherah, and for all the host of heaven." **2 KINGS 23:4**
TRUE OR FALSE
7. "And he burned them outside Jerusalem in the fields of Kidron, and carried their ashes to Bethel." **2 KINGS 23:4**
TRUE OR FALSE

CIRCLE THE CORRECT WORDS:

8. "Then he removed the idolatrous priests whom the (**KINGS, GOD**) of Judah had ordained to burn incense on the high places in the cities of Judah and in the places all around Jerusalem." **2 KINGS 23:5**
9. "And he brought out the wooden (**IMAGE, MIRAGE**) from the house of the LORD, to the Brook Kidron outside Jerusalem, burned it at the Brook Kidron and ground it to ashes, and threw its ashes on the graves of the common people." **2 KINGS 23:6**
10. "As Josiah turned, he saw the (**COMBS, TOMBS**) that were there on the mountain." **2 KINGS 23:16**
11. "Then he said, 'What gravestone is this that I see?' And the men of the city told him, 'It is the tomb of the man of God who came from Judah and proclaimed these things which you have done against the (**PEOPLE, ALTAR**) of Bethel.'" **2 KINGS 23:17**
12. "Now before him there was no king like him, who turned to the (**LORD, WORLD**) with all his heart, with all his soul, and with all his might." **2 KINGS 23:25**

116. JOSIAH

(2 KINGS 22:1-2; 23:1-30)

C B Z E Z N Y B B N B I I D D
 O J H C Z B C G F O V Y R T S
 V Q E R L U O S H R D R O M T
 E K A C W K T A O D H O E P T
 N K R J P O G L I I Q I J U W
 A V T J F O H G M K B T L R N
 N H U T E B A N A K W E B P G
 T S O H P R D I G O Q H N T F
 Z T W H R T U K E O I A Z Y O
 T O T L I O J S C R J I Z L B
 A L E Z E M B L A B G S Q O M
 S S M R S B R V G L P O N R I
 H T P L T Q B C S Z E J M D G
 E R L P S C T B M B C M P W H
 S W E J Q J G R E O Q H G Y T

ASHES

JERUSALEM

MIGHT

BOOK

JOSIAH

PRIESTS

BROOK KIDRON

JUDAH

SOUL

COVENANT

KING

TEMPLE

HEART

LORD

TOMB

IMAGE

116. JOSIAH

(2 KINGS 22:1-2; 23:1-30)

MEMORY VERSE:

"Now before him there was no king like him, who turned to the LORD with all his heart, with all his soul, and with all his might." 2 KINGS 23:25

TRUE OR FALSE:

1. "Josiah was eight years old when he became king, and he reigned thirty-one years in Jerusalem." **2 KINGS 22:1**

TRUE OR FALSE

2. "He did what was right in the sight of the LORD, and walked in all the ways of his father David; he did not turn aside to the right hand or to the left." **2 KINGS 22:2**

TRUE OR FALSE

FILL IN THE BLANKS:

3. Josiah "the king went up to the house of the LORD with all the men of Judah, and with him all the inhabitants of Jerusalem- the priests and prophets and all the people, both small and great; and he _____ in their hearing all the words of the Book of the Covenant which had been found in the house of the LORD." **2 KINGS 23:2**

4. "Then the king stood by a pillar, and made a _____ before the LORD, to follow the LORD and to keep His commandments and His testimonies and His statutes, with all his heart and all his soul, to perform the words of this covenant that were written in this book." **2 KINGS 23:3**

TRUE OR FALSE:

5. But none of the people took their stand for the covenant. **2 KINGS 23:3**

TRUE OR FALSE

6. "And the king commanded Hilkiah the high priest, the priests of the second order, and the doorkeepers, to bring out of the temple of the LORD all the articles that were made for Baal, for Asherah, and for all the host of heaven." **2 KINGS 23:4**

TRUE OR FALSE

7. "And he burned them outside Jerusalem in the fields of Kidron, and carried their ashes to Bethel." **2 KINGS 23:4**

TRUE OR FALSE

FILL IN THE BLANKS:

8. "Then he removed the idolatrous priests whom the _____ of Judah had ordained to burn incense on the high places in the cities of Judah and in the places all around Jerusalem." **2 KINGS 23:5**

9. "And he brought out the wooden _____ from the house of the LORD, to the Brook Kidron outside Jerusalem, burned it at the Brook Kidron and ground it to ashes, and threw its ashes on the graves of the common people." **2 KINGS 23:6**

10. "As Josiah turned, he saw the _____ that were there on the mountain." **2 KINGS 23:16**

11. "Then he said, 'What gravestone is this that I see?' And the men of the city told him, 'It is the tomb of the _____ who came from Judah and proclaimed these things which you have done against the altar of Bethel.'" **2 KINGS 23:17**

12. "Now before him there was no king like him, who turned to the _____ with all his heart, with all his soul, and with all his might." **2 KINGS 23:25**

116. JOSIAH

(2 KINGS 22:1-2; 23:1-30)

N D Z B L S C H N N U Y Y H L Y D O C C
 O T H B L B S G S Z U B L L A K O M R M
 N T R Y M P L U H S R O H D G E T M H G
 C Q S U S Z S Q P V J J R I H O C G N K
 N F A E O S N J P M Z C B H A I S O J M
 B N A W H M P N R O F B L P G J U Q C P
 I F J D A S M V O M J G N M N S V O N E
 F T Y O I M A G E R F T R A E H V O V I
 A H G K L B N L B N D W D W W E H T G P
 W D H J K A A Q S G E I O L N Z A H R L
 N T S Q N S Q T N B O H K A B N D K K E
 B N E W U B S D O I D H N K W W U W Z P
 Y Y Q R M E Q O G R R T F G O I J E L K
 K B E Z I I K D O C I B N S B O L W N S
 Y J M R G Y H L B N Y M Q Z V P R M I N
 T P P P G T V D L E S B R R M O N B V U
 P W G Q T F Z V L B M S K E B V V L V W
 S U B N E Z U V N O O B T O H M M R T S
 J L W L I B D D T U Y U D J C G U Q L C
 V N C A L K B L L P D L F L O T H G I M

ASHES

JERUSALEM

MIGHT

BOOK

JOSIAH

PRIESTS

BROOK KIDRON

JUDAH

SOUL

COVENANT

KING

TEMPLE

HEART

LORD

TOMB

IMAGE

116. JOSIAH

(2 KINGS 22:1-2; 23:1-30)

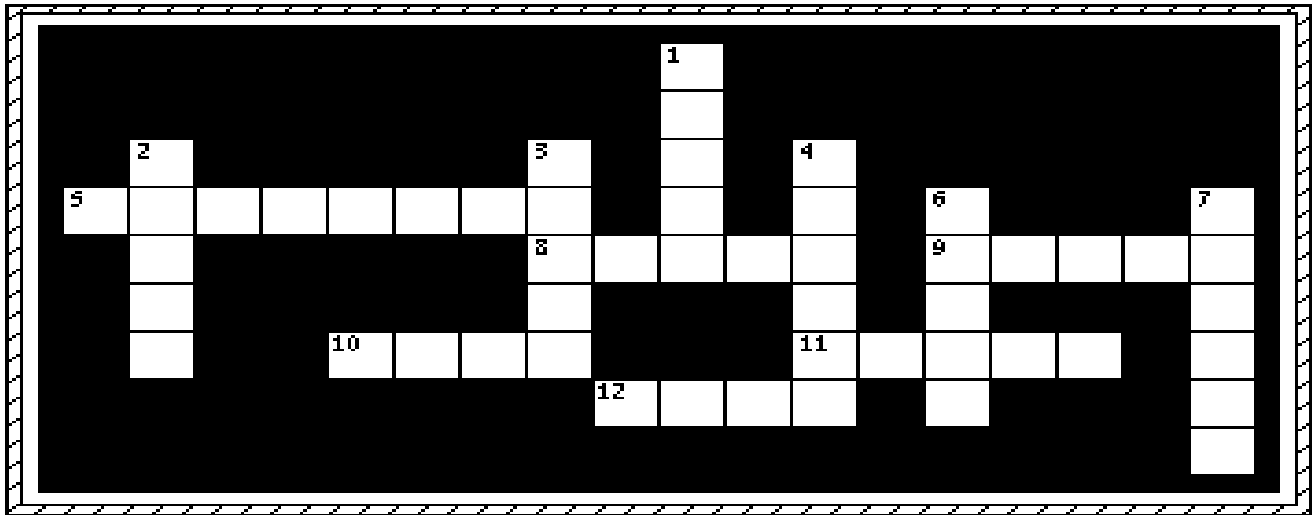

- 11 ACROSS "Josiah was _____ years old when he became king, and he reigned thirty-one years in Jerusalem." **2 KINGS 22:1**
- 1 DOWN "He did what was _____ in the sight of the LORD, and walked in all the ways of his father David; he did not turn aside to the right hand or to the left." **2 KINGS 22:2**
- 10 ACROSS "He _____ in their hearing all the words of the Book of the Covenant which had been found in the house of the LORD." **2 KINGS 23:2**
- 5 ACROSS "Then the king stood by a pillar, and made a _____ before the LORD." **2 KINGS 23:3**
- 3 DOWN "And all the people took their _____ for the covenant." **2 KINGS 23:3**
- 7 DOWN "And the king commanded Hilkiah the high priest, the priests of the second order, and the doorkeepers, to bring out of the _____ of the LORD all the articles that were made for Baal, for Asherah, and for all the host of heaven." **2 KINGS 23:4**
- 4 DOWN "And he _____ them outside Jerusalem in the fields of Kidron, and carried their ashes to Bethel." **2 KINGS 23:4**
- 6 DOWN "Then he removed the idolatrous priests whom the _____ of Judah had ordained to burn incense on the high places in the cities of Judah and in the places all around Jerusalem." **2 KINGS 23:5**
- 9 ACROSS "And he brought out the wooden _____ from the house of the LORD." **2 KINGS 23:6**
- 2 DOWN "As Josiah turned, he saw the _____ that were there on the mountain." **2 KINGS 23:16**
- 8 ACROSS "Then he said, 'What gravestone is this that I see?' And the men of the city told him, 'It is the tomb of the man of God who came from Judah and proclaimed these things which you have done against the _____ of Bethel.'" **2 KINGS 23:17**
- 12 ACROSS "Now before him there was no king like him, who turned to the _____ with all his heart, with all his soul, and with all his might." **2 KINGS 23:25**

Bible Story 117

**THE BOOK OF THE
LAW IS FOUND**

2 KINGS 22:3-20

117. THE BOOK OF THE LAW IS FOUND

(2 KINGS 22:3-20)

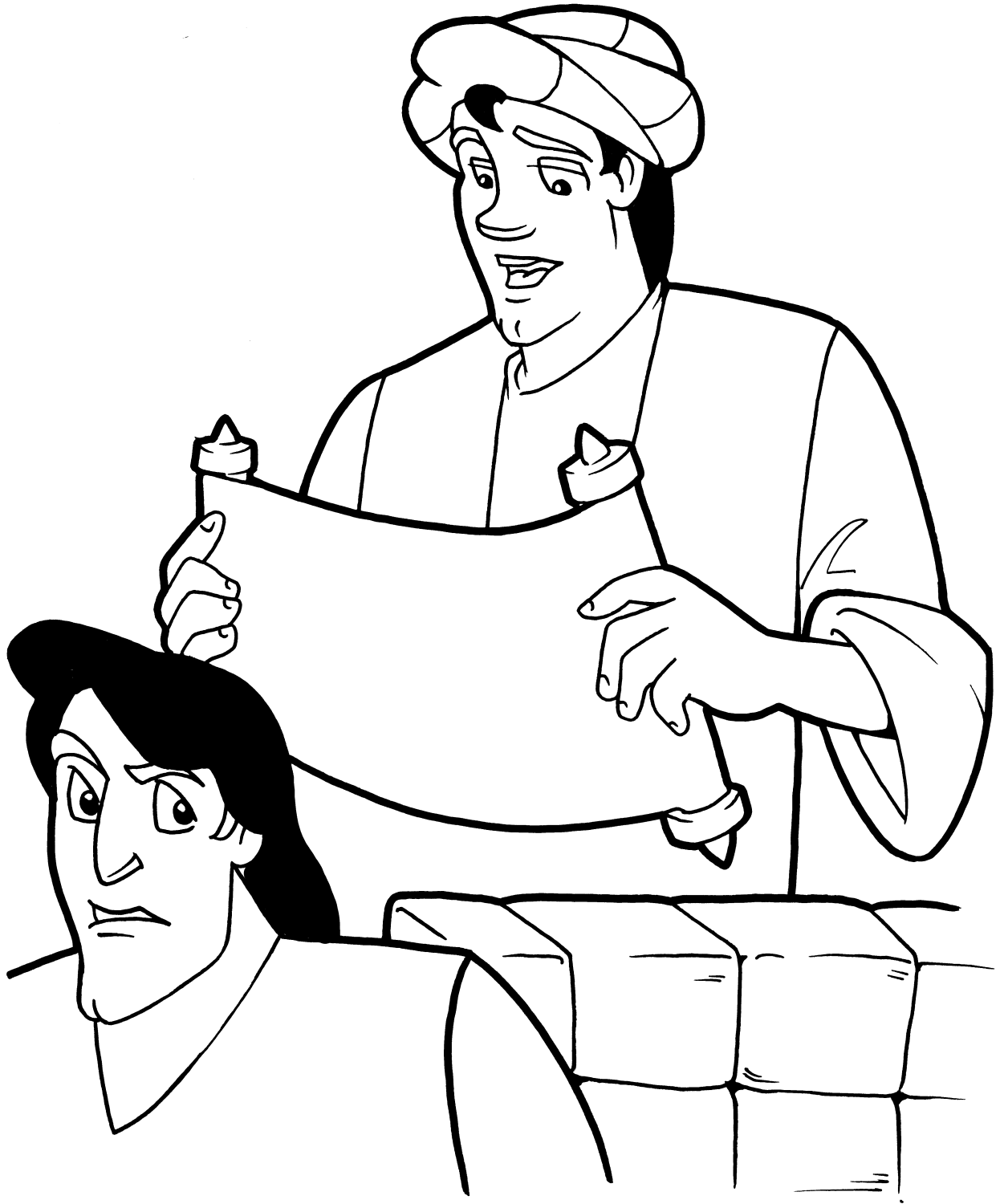

"And Hilkiyah the high priest said unto Shaphan the scribe, I have found the book of the law in the house of the LORD. And Hilkiyah gave the book to Shaphan, and he read it."

2 KINGS 22:8

117. THE BOOK OF THE LAW IS FOUND

(2 KINGS 22:3-20)

MEMORY VERSE:

"Because your heart was tender, and you humbled yourself before the LORD when you heard what I spoke against this place and against its inhabitants, that they would become a desolation and a curse, and you tore your clothes and wept before Me, I also have heard you," says the LORD. "
2 KINGS 22:18-19

TRUE OR FALSE:

1. "Now it came to pass, in the eighteenth year of King Josiah, that the king sent Shaphan the scribe, the son of Azaliah, the son of Meshullam, to the house of the LORD, saying: 'Go up to Hilkiyah the high priest, that he may count the money which has been brought into the house of the LORD, which the doorkeepers have gathered from the people.' " **2 KINGS 22:3-4**

TRUE OR FALSE

CIRCLE THE CORRECT WORDS:

2. "Then Hilkiyah the high priest said to Shaphan the scribe, 'I have (**LOST**, **FOUND**) the Book of the Law in the house of the LORD.' " **2 KINGS 22:8**
3. "And Hilkiyah gave the book to Shaphan, and he (**LOST**, **READ**) it." **2 KINGS 22:8**
4. "Now it happened, when the king heard the words of the Book of the Law, that he (**TORE**, **BOUGHT**) his clothes." **2 KINGS 22:11**
5. The king commanded Hilkiyah, "Go, inquire of the LORD for me, for the people and for all Judah, concerning the words of this book that has been found; for (**GREAT**, **SMALL**) is the wrath of the LORD that is aroused against us, because our fathers (**HAVE**, **HAVE NOT**) obeyed the words of this book, to do according to all that is written concerning us." **2 KINGS 22:13**

TRUE OR FALSE:

6. "So Hilkiyah the priest, Ahikam, Achbor, Shaphan, and Asaiah went to Huldah the prophetess." **2 KINGS 22:14**
- TRUE OR FALSE

CIRCLE THE CORRECT WORD:

7. "Then she said to them, 'Thus says the LORD God of Israel, "Tell the man who sent you to me, 'Thus says the LORD: "Behold, I will bring (**CALAMITY**, **JOY**) on this place and on its inhabitants- all the words of the book which the king of Judah has read.' " " " **2 KINGS 22:15-16**

FILL IN THE BLANKS:

8. "But to the king of Judah, who sent you to inquire of the LORD, in this manner you shall speak to him, 'Thus says the LORD God of Israel: "Concerning the words which you have read- because your heart was _____, and you _____ yourself before the LORD when you heard what I spoke against this place and against its inhabitants, that they would become a desolation and a curse, and you tore your clothes and wept before Me, I also have heard you," says the LORD.' " **2 KINGS 22:18-19**

CIRCLE THE CORRECT WORD(S):

9. Also it was said to the king, "Surely, therefore, I will gather you to your fathers, and you shall be gathered to your grave in peace; and your eyes (**SHALL**, **SHALL NOT**) see all the calamity which I will bring on this place." **2 KINGS 22:20**

117. THE BOOK OF THE LAW IS FOUND (2 KINGS 22:3-20)

H U M B L E D N Q K K Y D Q D
 H B I O S O B C N W U H F N W
 T D Y B S R G V Y L N N B I T
 T C O J O M E S H A P H A N L
 R D B G S O C P M W U O E S A
 R W B W D J K C E W D K I N G
 Y K P H I R Z O A E H I H V O
 E I P Y I K O C F A K R T U A
 N E Y T A L H L I T L R L U P
 O D F I G G K S E Z H R O A A
 M N H M W H O I S H U E E O D
 W U T A A J K H A O T F L A D
 P O A L F G K R V H F Y U A D
 N F R A U D R E Y A L N W D W
 K P W C T V E M H U L D A H Y

BOOK OF THE LAW
 CALAMITY
 DOORKEEPERS
 FOUND
 HILKIAH

HULDAH
 HUMBLED
 JOSIAH
 KING
 MONEY

READ
 SHAPHAN
 THE LORD GOD
 WRATH

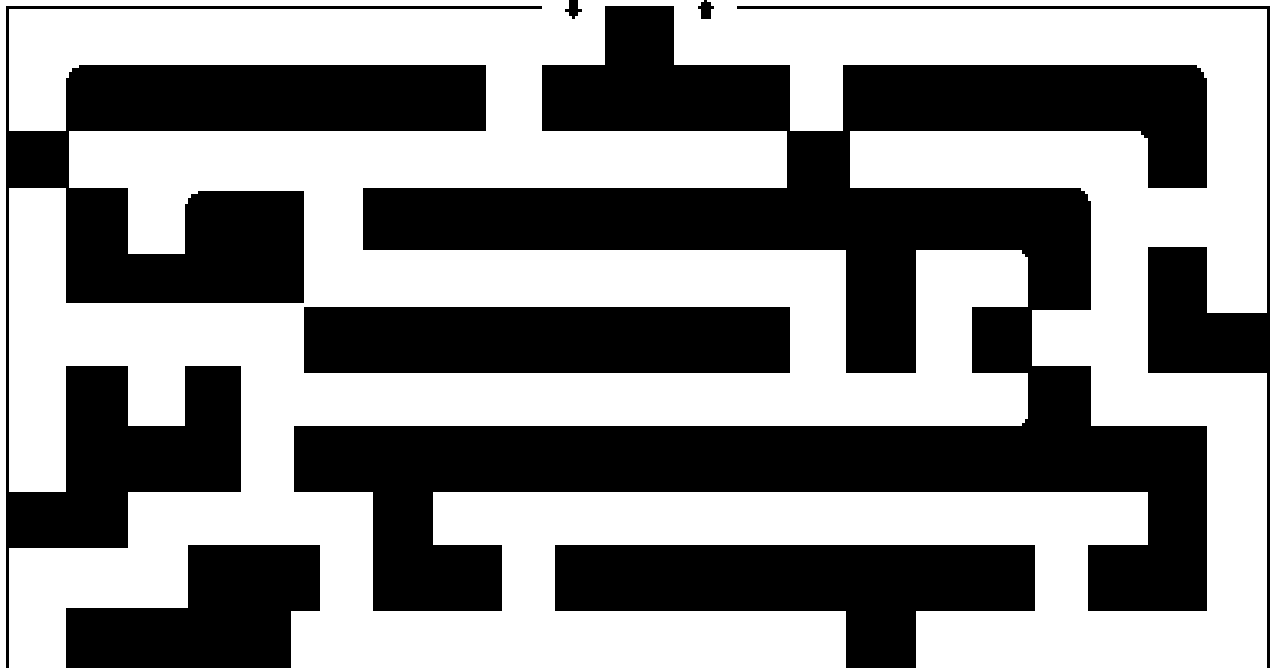

117. THE BOOK OF THE LAW IS FOUND

(2 KINGS 22:3-20)

MEMORY VERSE:

"Because your heart was tender, and you humbled yourself before the LORD when you heard what I spoke against this place and against its inhabitants, that they would become a desolation and a curse, and you tore your clothes and wept before Me, I also have heard you," says the LORD. "
2 KINGS 22:18-19

TRUE OR FALSE:

1. "Now it came to pass, in the eighteenth year of King Josiah, that the king sent Shaphan the scribe, the son of Azaliah, the son of Meshullam, to the house of the LORD, saying: 'Go up to Hilkiyah the high priest, that he may count the money which has been brought into the house of the LORD, which the doorkeepers have gathered from the people.' " **2 KINGS 22:3-4**

TRUE OR FALSE

FILL IN THE BLANKS:

2. "Then Hilkiyah the high priest said to Shaphan the scribe, 'I have _____ the Book of the Law in the house of the LORD.' " **2 KINGS 22:8**
3. "And Hilkiyah gave the book to Shaphan, and he _____ it." **2 KINGS 22:8**
4. "Now it happened, when the king heard the words of the Book of the Law, that he _____ his clothes."
2 KINGS 22:11
5. The king commanded Hilkiyah, "Go, inquire of the LORD for me, for the people and for all Judah, concerning the words of this book that has been found; for _____ is the wrath of the LORD that is aroused against us, because our fathers _____ obeyed the words of this book, to do according to all that is written concerning us." **2 KINGS 22:13**

TRUE OR FALSE:

6. "So Hilkiyah the priest, Ahikam, Achbor, Shaphan, and Asaiah went to Huldah the prophetess." **2 KINGS 22:14**

TRUE OR FALSE

FILL IN THE BLANKS:

7. "Then she said to them, 'Thus says the LORD God of Israel, "Tell the man who sent you to me, 'Thus says the LORD: "Behold, I will bring _____ on this place and on its inhabitants- all the words of the book which the king of Judah has read." ' ' ' " **2 KINGS 22:15-16**
8. "But to the king of Judah, who sent you to inquire of the LORD, in this manner you shall speak to him, 'Thus says the LORD God of Israel: "Concerning the words which you have read- because your heart was _____, and you _____ yourself before the LORD when you heard what I spoke against this place and against its inhabitants, that they would become a desolation and a curse, and you tore your clothes and wept before Me, I also have heard you," says the LORD.' " **2 KINGS 22:18-19**

CIRCLE THE CORRECT WORD(S):

9. Also it was said to the king, "Surely, therefore, I will gather you to your fathers, and you shall be gathered to your grave in peace; and your eyes (**SHALL, SHALL NOT**) see all the calamity which I will bring on this place."
2 KINGS 22:20

117. THE BOOK OF THE LAW IS FOUND (2 KINGS 22:3-20)

C F G E V G M C P D L A E E N G L F J L
 E N D U V M A T Z Z B B P G W K K S Z K
 T W O L F W Q C J W U P N H H V U P G I
 G Q O N W H W N F G H I J W A E V A V Y
 I S R N G K P L J Z K S A A I I W P T K
 T D K T L L J O W Y Q L Z R S T H G H M
 Z E E E J F Y Z Q T E T J O O R O M E H
 Q D E A Z N W Y U H O Y H T J V A H L I
 Y U P D W Q D S T R J D N U O F H D O L
 H S E E L Y C F J L N L F R Q I W C R K
 Q N R M K K O H N U G Y E N O M A B D I
 H J S K I K V R N K A V R H A L M H G A
 S U S T O R S H A P H A N V A K G F O H
 E D M O B V S V V U E O K M V D S L D S
 N W B B A U R I J H S C I J U D W I Z V
 R K B B L P Q H Z P U T Y H D O N R C O
 F H I D K E B H A T Y L S D L C P A K M
 B P P B S F D R D H E T D H Z J N M R R
 P K Q N H T A R W S Q Z S A N A R Z A Z
 A J C L R E A D S D P O D P H S N W I F

BOOK OF THE LAW

HULDAH

READ

CALAMITY

HUMBLED

SHAPHAN

DOORKEEPERS

JOSIAH

THE LORD GOD

FOUND

KING

WRATH

HILKIAH

MONEY

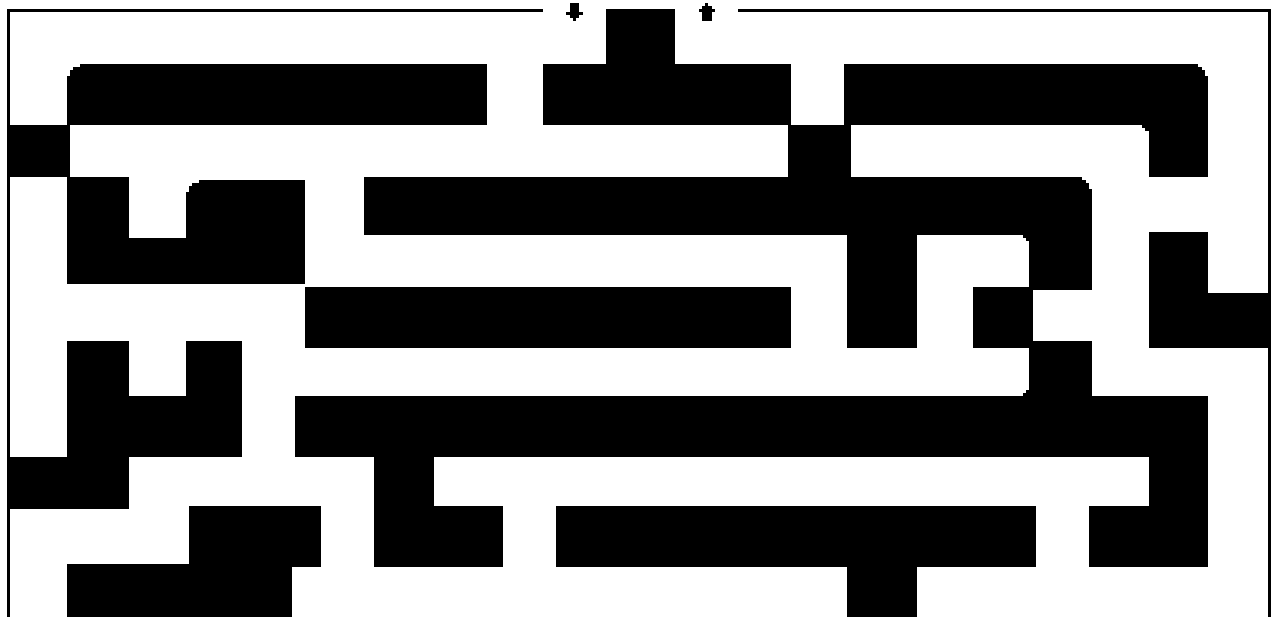

117. THE BOOK OF THE LAW IS FOUND

(2 KINGS 22:3-20)

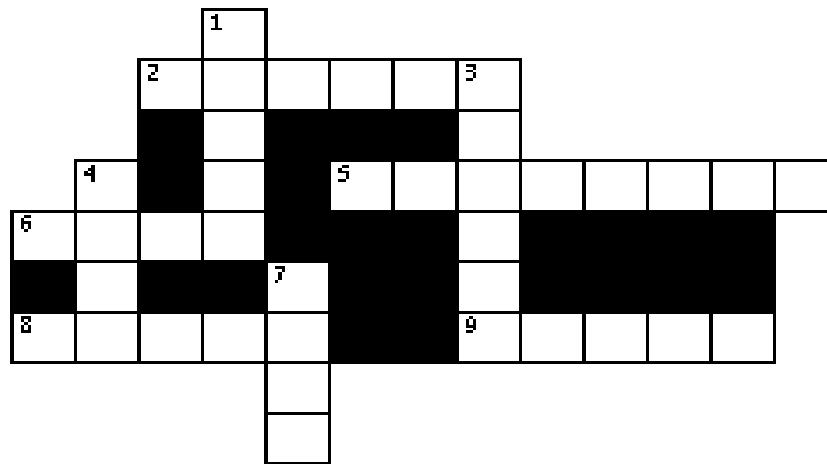

- 2 ACROSS "Now it came to pass, in the eighteenth year of King _____, that the king sent Shaphan the scribe, the son of Azaliah, the son of Meshullam, to the house of the LORD, saying: 'Go up to Hilkiah the high priest, that he may count the money which has been brought into the house of the LORD, which the doorkeepers have gathered from the people.'" **2 KINGS 22:3-4**
- 1 DOWN "Then Hilkiah the high priest said to Shaphan the scribe, 'I have _____ the Book of the Law in the house of the LORD.'" **2 KINGS 22:8**
- 7 DOWN "And Hilkiah gave the book to Shaphan, and he _____ it." **2 KINGS 22:8**
- 4 DOWN "Now it happened, when the king heard the words of the Book of the Law, that he _____ his clothes." **2 KINGS 22:11**
- 6 ACROSS The king commanded Hilkiah, "Go, inquire of the _____ for me, for the people and for all Judah, concerning the words of this book that has been found; for great is the wrath of the LORD that is aroused against us, because our fathers have not obeyed the words of this book, to do according to all that is written concerning us." **2 KINGS 22:13**
- 3 DOWN "So Hilkiah the priest, Ahikam, Achbor, Shaphan, and Asaiah went to _____ the prophetess." **2 KINGS 22:14**
- 5 ACROSS "Then she said to them, 'Thus says the LORD God of Israel, "Tell the man who sent you to me, Thus says the LORD: "Behold, I will bring _____ on this place and on its inhabitants- all the words of the book which the king of Judah has read." ' ' ' ' " **2 KINGS 22:15-16**
- 9 ACROSS "But to the king of Judah, who sent you to inquire of the LORD, in this manner you shall speak to him, 'Thus says the LORD God of Israel: "Concerning the words which you have read- because your heart was tender, and you humbled yourself before the LORD when you heard what I spoke against this place and against its inhabitants, that they would become a desolation and a curse, and you tore your clothes and wept before Me, I also have _____ you," says the LORD.'" **2 KINGS 22:18-19**
- 8 ACROSS Also it was said to the king, "Surely, therefore, I will gather you to your fathers, and you shall be gathered to your grave in _____; and your eyes (**SHALL, SHALL NOT**) see all the calamity which I will bring on this place." **2 KINGS 22:20**

Bible Story 118

**JUDAH IS LEAD
INTO CAPTIVITY**

2 KINGS 25:1-21

118. JUDAH IS LED INTO CAPTIVITY

(2 KINGS 25:1-21)



"Thus Judah was carried away captive from its own land."
2 KINGS 25:21

118. JUDAH IS LED INTO CAPTIVITY

(2 KINGS 25:1-21)

MEMORY VERSE:

"Thus Judah was carried away captive from its own land." 2 KINGS 25:21

TRUE OR FALSE:

1. "Nebuchadnezzar king of Babylon and all his army came against Jerusalem and encamped against it; and they built a siege wall against it all around." **2 KINGS 25:1**
TRUE OR FALSE
2. "By the ninth day of the fourth month the famine had become so severe in the city that there was no food for the people of the land." **2 KINGS 25:3**
TRUE OR FALSE

CIRCLE THE CORRECT WORDS:

3. "Then the city wall was broken through, and all the men of war (**SLEPT, FLED**) at night by way of the gate between two walls, which was by the king's garden, even though the Chaldeans were still encamped all around against the city." **2 KINGS 25:4**
4. "But the army of the Chaldeans pursued the king, and they (**OVERTOOK, OVERLOOKED**) him in the plains of Jericho. All his army scattered from him." **2 KINGS 25:5**
5. "Nebuzaradan the captain of the guard, a servant of the king of Babylon, came to Jerusalem. He (**BURNED, BUILT**) the house of the LORD and the king's house; all the houses of Jerusalem, that is, all the houses of the great men, he burned with fire." **2 KINGS 25:8-9**
6. "And all the army of the Chaldeans who were with the captain of the guard broke down the (**WALLS, HALLS**) of Jerusalem all around." **2 KINGS 25:10**

TRUE OR FALSE:

7. "Then Nebuzaradan the captain of the guard carried away captive the rest of the people who remained in the city and the defectors who had deserted to the king of Babylon, with the rest of the multitude." **2 KINGS 25:11**
TRUE OR FALSE
8. The captain of the guard also took all of the poor of the land and left no one as vinedressers or farmers. **2 KINGS 25:12**
TRUE OR FALSE

"Thus Judah was carried away captive from its own land." 2 KINGS 25:21

118. JUDAH IS LED INTO CAPTIVITY

(2 KINGS 25:1-21)

H O U S E O F T H E L O R D N
 J Y J U D A H G S Q L U N E N
 E A G D O M H B C Y L O B E G
 R W L Q O N U A M O L U B V A
 U A W J F R P R U Y C U O K T
 S D D J N T A W B H Z W W I N
 A E I E I B N A A A D K H N B
 L I D V U A B D R V N Y J G B
 E R E C D S N A J Y F Y S N F
 M R C N I E D K S B L E R A L
 Q A P V Z A F E L C E H M G W
 G C L Z N P I O J J D I V O A
 H Q A D V G G I T N N L J Q L
 M R O I E W I L B E K B D A L
 G W P M E J E D V B A R U E S

ARMY	FAMINE	KING
BABYLON	FLED	NEBUCHADNEZZAR
BURNED	HOUSE OF THE LORD	NEBUZARADAN
CAPTIVE	JERUSALEM	SEIGE
CARRIED AWAY	JUDAH	WALLS

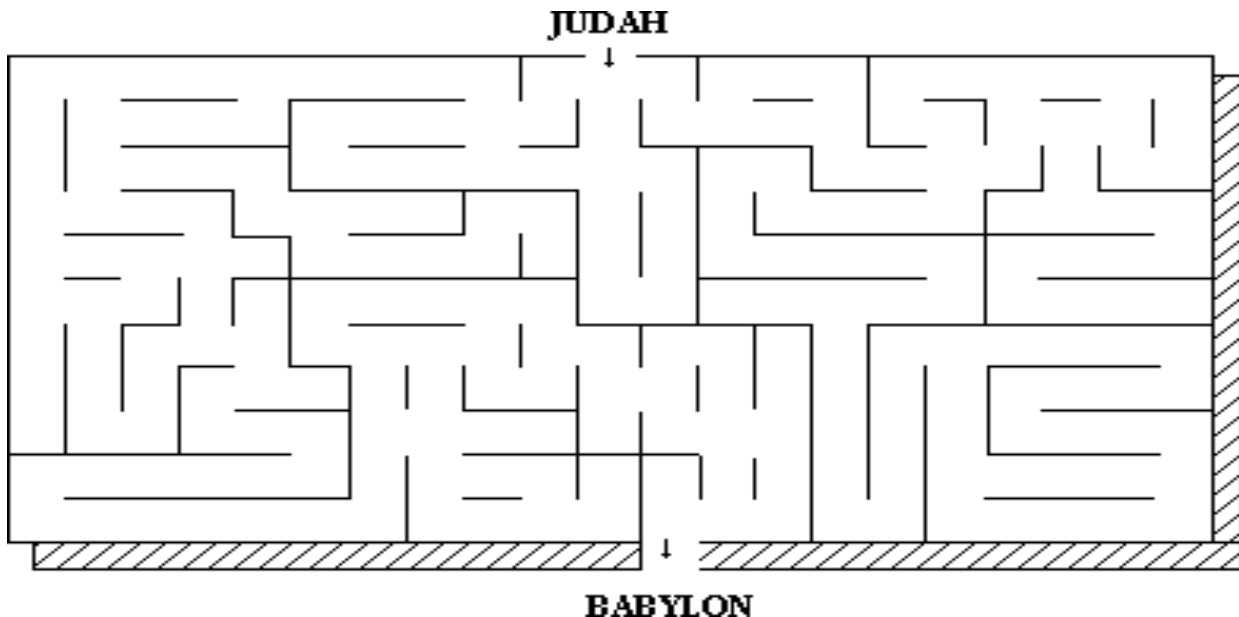

118. JUDAH IS LED INTO CAPTIVITY

(2 KINGS 25:1-21)

MEMORY VERSE:

"Thus Judah was carried away captive from its own land." 2 KINGS 25:21

TRUE OR FALSE:

1. "Nebuchadnezzar king of Babylon and all his army came against Jerusalem and encamped against it; and they built a siege wall against it all around." **2 KINGS 25:1**
TRUE OR FALSE
2. "By the ninth day of the fourth month the famine had become so severe in the city that there was no food for the people of the land." **2 KINGS 25:3**
TRUE OR FALSE

FILL IN THE BLANKS:

3. "Then the city wall was broken through, and all the men of war _____ at night by way of the gate between two walls, which was by the king's garden, even though the Chaldeans were still encamped all around against the city." **2 KINGS 25:4**
4. "But the army of the Chaldeans pursued the king, and they _____ him in the plains of Jericho. All his army scattered from him." **2 KINGS 25:5**
5. "Nebuzaradan the captain of the guard, a servant of the king of Babylon, came to Jerusalem. He _____ the house of the LORD and the king's house; all the houses of Jerusalem, that is, all the houses of the great men, he _____ with fire." **2 KINGS 25:8-9**
6. "And all the army of the Chaldeans who were with the captain of the guard broke down the _____ of Jerusalem all around." **2 KINGS 25:10**

TRUE OR FALSE:

7. "Then Nebuzaradan the captain of the guard carried away captive the rest of the people who remained in the city and the defectors who had deserted to the king of Babylon, with the rest of the multitude." **2 KINGS 25:11**
TRUE OR FALSE
8. The captain of the guard also took all of the poor of the land and left no one as vinedressers or farmers. **2 KINGS 25:12**
TRUE OR FALSE

"Thus Judah was carried away captive from its own land." 2 KINGS 25:21

118. JUDAH IS LED INTO CAPTIVITY (2 KINGS 25:1-21)

U L V I D E N R U B A H S D T S E N O Y
 N V D Y E P G H M G J W U R G V G N I K
 Y C H R J U F Z Q E S C I O P H N O E K
 A B Q O L R O N R A M E I L M W H G B C
 W H B I B P B U F H U D Y E R S A K Q D
 A L K T N T S M U Q E R U H Y G D D P O
 D F Q E N A R B N L Z Z W T L T U N W L
 E H I H L E N O F Q N B Y F E W J M Q F
 I O J E Z Y B M Q Y A P F O H A Y U P K
 R C M I Z W R U G C D M Y E R L I G O Q
 R C A P T I V E C L A B O S I L Y S G U
 A N O L Y B A B T H R U S U V S Q Q B S
 C G G E Q Y A C C V A F U O V B S P T R
 B S P N N D G A A M Z D B H T U W H Y T
 T M A I B S M C B O U S N T R C J R W F
 G E R M P S E B N B B U U E A G K R K J
 N Z M A G T W I B I E Y G D Z B T Q I S
 G B Y F D T O X G B N P O H L Z P T G J
 A O C M T W W N I E O B M Y J A A Y R E
 L B Q O M N T I B H B K N J K K E R E F

ARMY	FAMINE	KING
BABYLON	FLED	NEBUCHADNEZZAR
BURNED	HOUSE OF THE LORD	NEBUZARADAN
CAPTIVE	JERUSALEM	SEIGE
CARRIED AWAY	JUDAH	WALLS

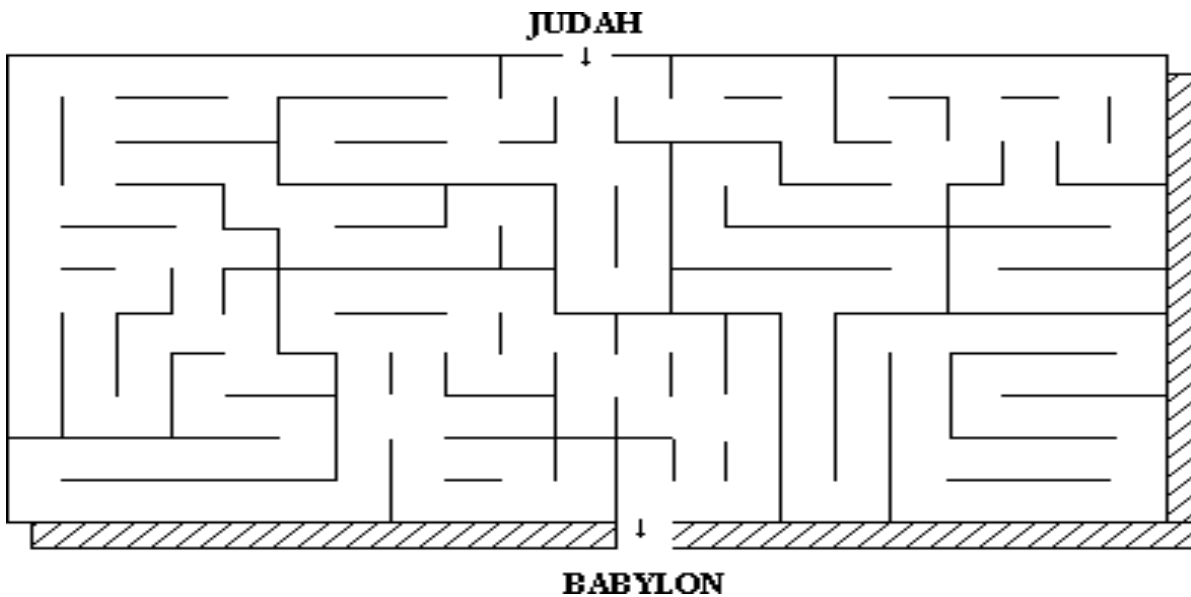

118. Judah is Led into Captivity

(2 Kings 25:1-21)

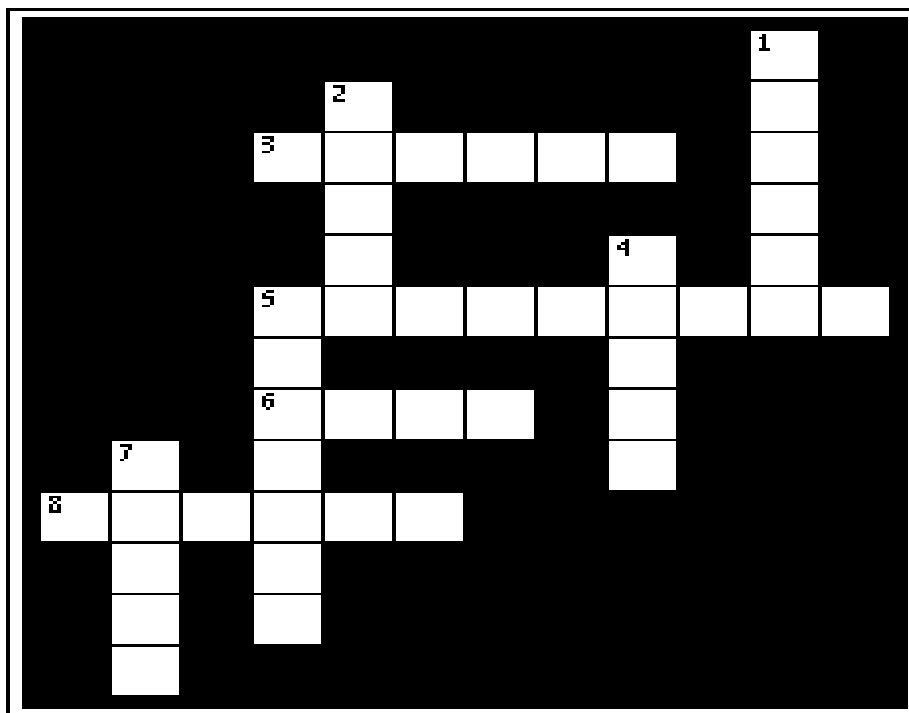

- 4 DOWN "Nebuchadnezzar king of Babylon and all his army came against Jerusalem and encamped against it; and they built a _____ wall against it all around." **2 KINGS 25:1**
- 8 ACROSS "By the ninth day of the fourth month the _____ had become so severe in the city that there was no food for the people of the land." **2 KINGS 25:3**
- 1 DOWN "Then the city wall was _____ through, and all the men of war fled at night by way of the gate between two walls, which was by the king's garden, even though the Chaldeans were still encamped all around against the city." **2 KINGS 25:4**
- 5 ACROSS "But the army of the _____ pursued the king, and they overtook him in the plains of Jericho. All his army scattered from him." **2 KINGS 25:5**
- 3 ACROSS "Nebuzaradan the captain of the guard, a servant of the king of Babylon, came to Jerusalem. He _____ the house of the LORD and the king's house; all the houses of Jerusalem, that is, all the houses of the great men, he burned with fire." **2 KINGS 25:8-9**
- 7 DOWN "And all the army of the Chaldeans who were with the captain of the guard broke down the _____ of Jerusalem all around." **2 KINGS 25:10**
- 5 DOWN "Then Nebuzaradan the captain of the guard carried away _____ the rest of the people who remained in the city and the defectors who had deserted to the king of Babylon, with the rest of the multitude." **2 KINGS 25:11**
- 6 ACROSS "But the captain of the guard left some of the _____ of the land as vinedressers and farmers." **2 KINGS 25:12**
- 2 DOWN "Thus _____ was carried away captive from its own land." **2 KINGS 25:21**

Bible Story 119

**CYRUS HELPS THE
EXILES TO RETURN**

EZRA 1:1-11

119. CYRUS HELPS THE EXILES

(EZRA 1:1-11)

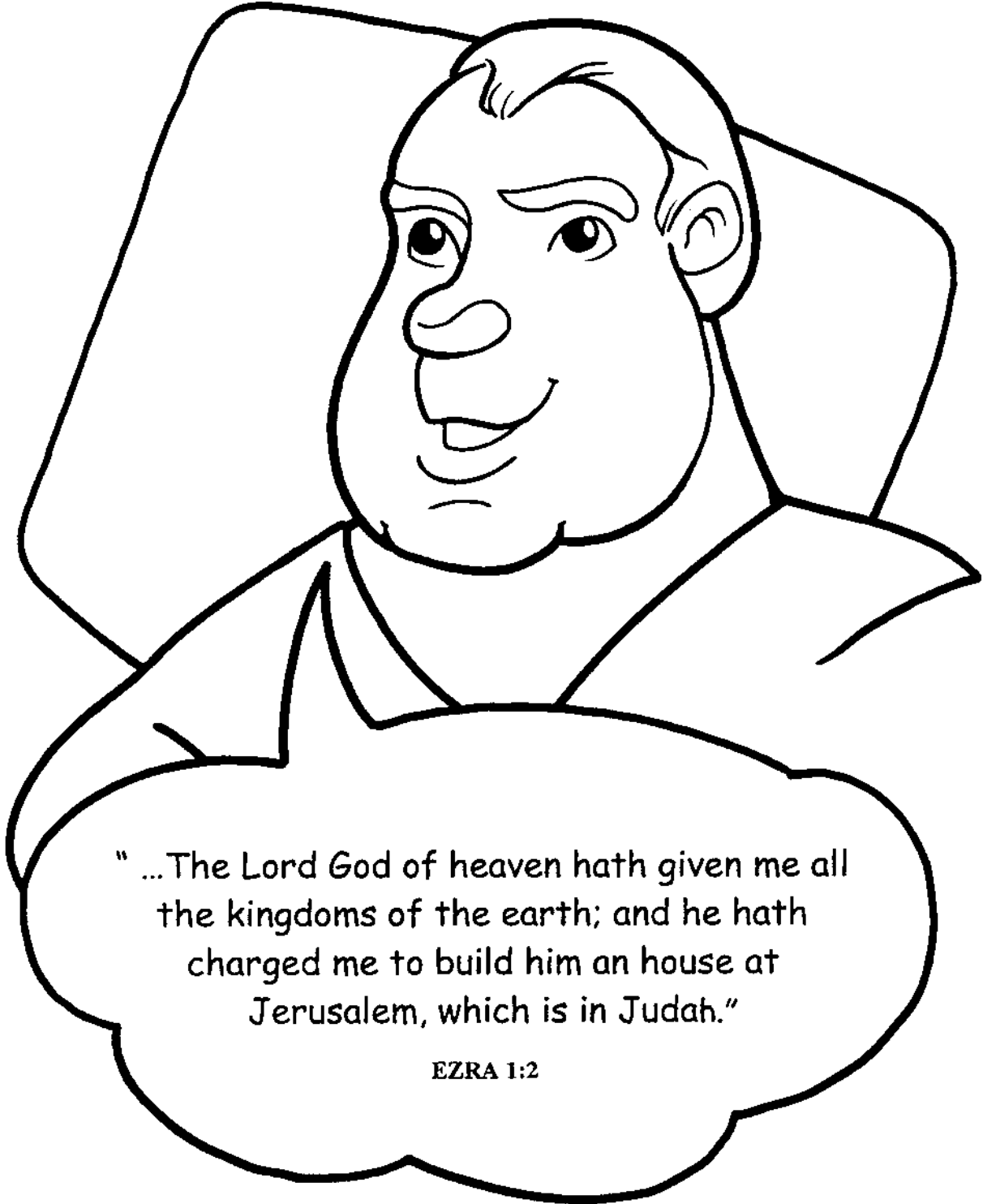

119. CYRUS HELPS THE EXILES

(EZRA 1:1-11)

MEMORY VERSE:

"I was glad when they said to me, 'Let us go into the house of the LORD.' " PSALM 122:1

TRUE OR FALSE:

1. "Now in the first year of Cyrus king of Persia, that the word of the LORD spoken by the mouth of Jeremiah might be fulfilled, the LORD stirred up the spirit of Cyrus king of Persia, so that he made a proclamation throughout all his kingdom, and also put it in writing." **EZRA 1:1**
TRUE OR FALSE

CIRCLE THE CORRECT WORD:

2. "Thus says Cyrus king of Persia: All the kingdoms of the earth the LORD God of heaven has given me. And He has commanded me to build Him a (**HOUSE, MOUSE**) at Jerusalem which is in Judah." **EZRA 1:2**

TRUE OR FALSE:

3. But the heads of the fathers' houses of Judah and Benjamin, and the priests and the Levites, and all those whose spirits God moved, would not arise to go up and build the house of the LORD which is in Jerusalem. **EZRA 1:5**
TRUE OR FALSE
4. "And all those who were around them encouraged them with articles of silver and gold, with goods and livestock, and with precious things, besides all that was willingly offered." **EZRA 1:6**
TRUE OR FALSE

CIRCLE THE CORRECT WORDS:

5. "King Cyrus also brought out the articles of the house of the LORD, which (**HEROD, NEBUCHADNEZZAR**) had taken from Jerusalem and put in the temple of his gods." **EZRA 1:7**
6. "And Cyrus king of Persia brought them out by the hand of Mithredath the treasurer, and counted them out to Sheshbazzar the prince of (**JUDAH, EGYPT**)." **EZRA 1:8**
7. "This is the number of them..." **EZRA 1:9-10**
thirty gold (**PLATTERS, HATTERS**)
one thousand silver (**PLATTERS, HATTERS**)
twenty-nine (**LIVES, KNIVES**)
thirty gold (**RAISINS, BASINS**)
four hundred and ten silver (**RAISINS, BASINS**) of a similar kind
and one thousand other (**ARTICLES, PARTICLES**)

FILL IN THE BLANKS:

8. "All the articles of _____ and _____ were five thousand four hundred." **EZRA 1:11**

TRUE OR FALSE:

9. "All these Sheshbazzar took with the captives who were brought from Babylon to Jerusalem."
EZRA 1:11
TRUE OR FALSE

119. CYRUS HELPS THE EXILES

(EZRA 1:1-11)

C A P T I V E S V I J I J N H
S V I H I Y W L B V H L T O E
S W P Y M H G O D A N D U B H
O K C O T S E V I L S S B L L
E I Q G Q G L P I E E I V L S
Z U N M J F O D M O F L N D R
S H R N B E W L F M G V Q S E
E I C U V Q R T D N I E O N T
V P G V B M H U O B E R N K T
I K O E W E D Q S A G O V A A
N R W Z L H C J O A L S Y U L
K E J O Y Y I J F Y L W D W P
P N R U R M C C B S W E C K B
E D V B U G P A U P K J M Y R
U A S B K Q B L D W O L J Y O

BABYLON

GOLD

LIVESTOCK

BASINS

HOUSE OF THE LORD

PLATTERS

CAPTIVES

JERUSALEM

SILVER

CYRUS

KNIVES

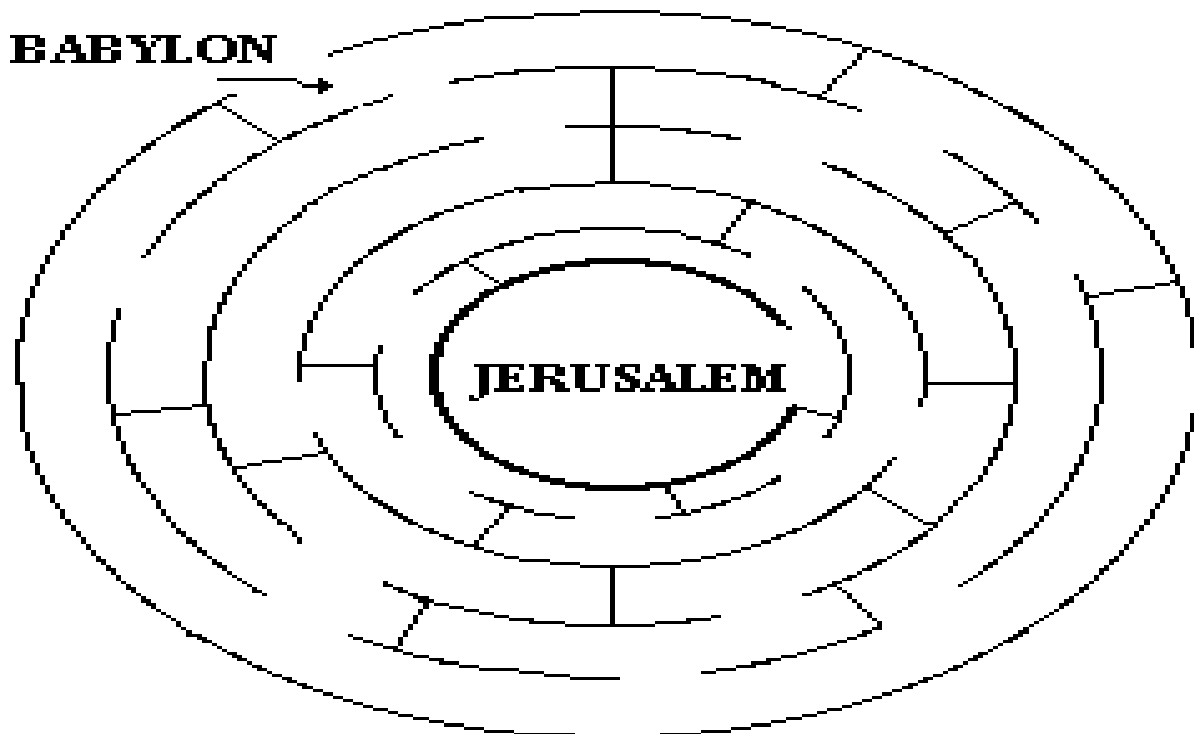

119. CYRUS HELPS THE EXILES

(EZRA 1:1-11)

MEMORY VERSE:

"I was glad when they said to me, 'Let us go into the house of the LORD.'" PSALM 122:1

TRUE OR FALSE:

1. "Now in the first year of Cyrus king of Persia, that the word of the LORD spoken by the mouth of Jeremiah might be fulfilled, the LORD stirred up the spirit of Cyrus king of Persia, so that he made a proclamation throughout all his kingdom, and also put it in writing." **EZRA 1:1**
TRUE OR FALSE

FILL IN THE BLANK:

2. "Thus says Cyrus king of Persia: All the kingdoms of the earth the LORD God of heaven has given me. And He has commanded me to build Him a _____ at Jerusalem which is in Judah." **EZRA 1:2**

TRUE OR FALSE:

3. But the heads of the fathers' houses of Judah and Benjamin, and the priests and the Levites, and all those whose spirits God moved, would not arise to go up and build the house of the LORD which is in Jerusalem. **EZRA 1:5**
TRUE OR FALSE
4. "And all those who were around them encouraged them with articles of silver and gold, with goods and livestock, and with precious things, besides all that was willingly offered." **EZRA 1:6**
TRUE OR FALSE

FILL IN THE BLANKS:

5. "King Cyrus also brought out the articles of the house of the LORD, which _____ had taken from Jerusalem and put in the temple of his gods." **EZRA 1:7**
6. "And Cyrus king of Persia brought them out by the hand of Mithredath the treasurer, and counted them out to Sheshbazzar the prince of _____." **EZRA 1:8**

CIRCLE THE CORRECT WORDS:

7. "This is the number of them..." **EZRA 1:9-10**
thirty gold (**PLATTERS, HATTERS**)
one thousand silver (**PLATTERS, HATTERS**)
twenty-nine (**LIVES, KNIVES**)
thirty gold (**RAISINS, BASINS**)
four hundred and ten silver (**RAISINS, BASINS**) of a similar kind
and one thousand other (**ARTICLES, PARTICLES**)

FILL IN THE BLANKS:

8. "All the articles of _____ and _____ were five thousand four hundred." **EZRA 1:11**

TRUE OR FALSE:

9. "All these Sheshbazzar took with the captives who were brought from Babylon to Jerusalem." **EZRA 1:11**
TRUE OR FALSE

119. CYRUS HELPS THE EXILES

(EZRA 1:1-11)

L Z W N P M J Z J J V E J J B P D O O I
 I M E L A S U R E J A C S I K P V B A K
 V R U G G L K Y H H R N B P K A S U T N
 E P F Z K B K N Q Q L Q E T A N M L M P
 S J I J B M P J O O W L S E L C I T R A
 T H R A Z Z A B H S E H S V G O L D Z P
 O G D P U A Z T A E J K S S I L V E R U
 C E G N K C Y P W W U D C E T V C P J Z
 K U Y U C W Y L V E O D A A V Q Z M S V
 W W P O U J O J M B E O V R P I L C M F
 S D Y F M U J C B N P B D F W T N C M R
 V D R O L E H T F O E S U O H S I K P K
 O W B L D R F V S S T Q Q E L U U V C K
 J Y D L L O A T W U W W E J A R T V E Y
 J P R N O L Y B A B S L N O B Y M Z D S
 E Z C M S I H W U H C W R U A C O B T R
 P R O C L A M A T I O N Y G S G E F N G
 A W G S V T A H D P H K Y F I N M K R I
 W B R Z R E H P S E U I D B N I N S G K
 L M G F C S R E T T A L P D S K N M E U

ARTICLES
 BABYLON
 BASINS
 CAPTIVES
 GOLD

HOUSE OF THE LORD
 JERUSALEM
 KING CYRUS
 KNIVES
 LIVESTOCK

PLATTERS
 PROCLAMATION
 SHESHBAZZAR
 SILVER

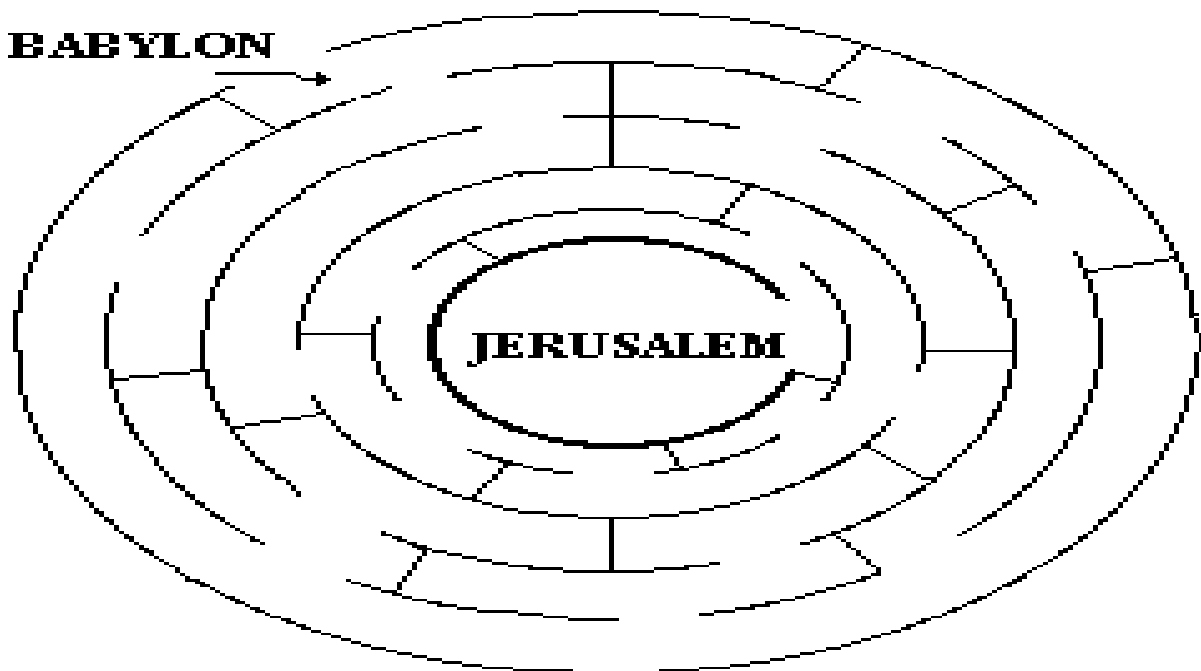

119. CYRUS HELPS THE EXILES

(EZRA 1:1-11)

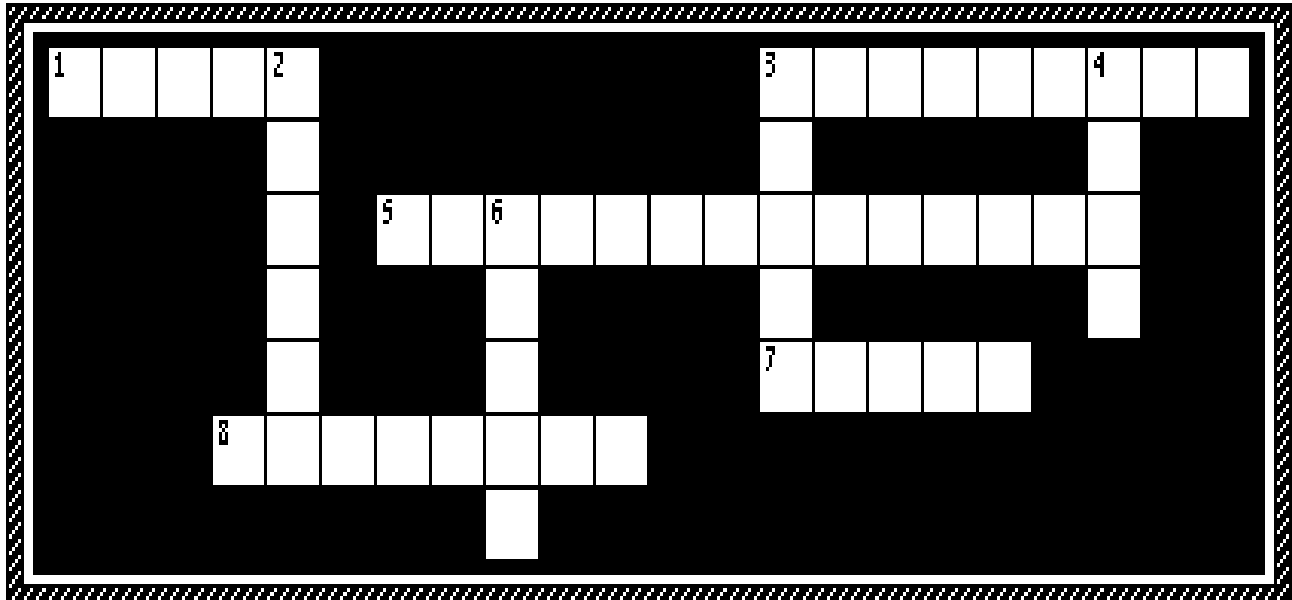

- 4 DOWN "I was glad when they said to me, 'Let us go into the house of the ____.'" **PSALM 122:1**
- 1 ACROSS "Now in the first year of Cyrus king of Persia, that the word of the LORD spoken by the mouth of Jeremiah might be fulfilled, the LORD stirred up the spirit of ____ king of Persia, so that he made a proclamation throughout all his kingdom, and also put it in writing." **EZRA 1:1**
- 7 ACROSS "Thus says Cyrus king of Persia: All the kingdoms of the earth the LORD God of heaven has given me. And He has commanded me to build Him a ____ at Jerusalem which is in Judah." **EZRA 1:2**
- 6 DOWN "Then the heads of the fathers' houses of Judah and Benjamin, and the priests and the Levites, and all those whose spirits God had moved, arose to go up and ____ the house of the LORD which is in Jerusalem." **EZRA 1:5**
- 8 ACROSS "And all those who were around them encouraged them with ____ of silver and gold, with goods and livestock, and with precious things, besides all that was willingly offered." **EZRA 1:6**
- 5 ACROSS "King Cyrus also brought out the articles of the house of the LORD, which ____ had taken from Jerusalem and put in the temple of his gods." **EZRA 1:7**
- 3 DOWN "And Cyrus king of Persia brought them out by the hand of Mithredath the treasurer, and counted them out to Sheshbazzar the prince of ____." **EZRA 1:8**
- 2 DOWN "All the articles of gold and ____ were five thousand four hundred." **EZRA 1:11**
- 3 ACROSS "All these Sheshbazzar took with the captives who were brought from Babylon to ____." **EZRA 1:11**

Bible Story 120

**REBUILDING
THE ALTAR &
THE TEMPLE**

EZRA 3:1-13

120. REBUILDING THE ALTAR AND THE TEMPLE

(EZRA 3:1-13)



"And when the builders laid the foundation of the temple of the LORD, they set the priests in their apparel with trumpets, and the Levites the sons of Asaph with cymbals, to praise the LORD, after the ordinance of David king of Israel."

EZRA 3:10

120. REBUILDING THE ALTAR AND THE TEMPLE

(EZRA 3:1-13)

MEMORY VERSE:

"Oh, give thanks to the LORD, for He is good! For His mercy endures forever."

PSALM 136:1

FILL IN THE BLANKS:

1. "The children of Israel were in the cities, the people gathered together as _____ to Jerusalem." **EZRA 3:1**

CIRCLE THE CORRECT WORD:

2. "Then Jeshua the son of Jozadak and his brethren the priests, and Zerubbabel the son of Shealtiel and his brethren, arose and built the (**ALTAR, HOUSE**) of the God of Israel, to offer burnt offerings on it, as it is written in the Law of Moses the man of God." **EZRA 3:2**

TRUE OR FALSE:

3. "The foundation of the temple of the LORD had not yet been laid." **EZRA 3:6**
TRUE OR FALSE

CIRCLE THE CORRECT WORD:

4. "They also gave money to the masons and the carpenters, and food, drink, and oil to the people of Sidon and Tyre to bring cedar (**HOGS, LOGS**) from Lebanon to the sea at Joppa, according to the permission which they had from Cyrus king of Persia." **EZRA 3:7**

TRUE OR FALSE:

5. "When the builders laid the foundation of the temple of the LORD, the priests stood in their apparel with trumpets, and the Levites, the sons of Asaph, with cymbals, to praise the LORD, according to the ordinance of David king of Israel." **EZRA 3:10**
TRUE OR FALSE

6. "And they sang responsively, praising and giving thanks to the LORD." **EZRA 3:11**
TRUE OR FALSE

CIRCLE THE CORRECT WORD:

7. "Then all the people shouted with a great shout, when they praised the LORD, because the foundation of the house of the LORD was (**DECAYED, LAID**)." **EZRA 3:11**

TRUE OR FALSE:

8. And all of the priests and Levites and heads of the fathers' houses, who were old men, who had seen the first temple, rejoiced. **EZRA 3:12**
TRUE OR FALSE

120. REBUILDING THE ALTAR AND THE TEMPLE

(EZRA 3;1-13)

C Y P R A I S E O F
E D T H A N K S O A
D E E O S J U U Q L
A T H W R D N A Y T
R U L H V D U C L A
L O B J A H R O A R
O H R T S E R C E A
G S I E M D V G G T
S O J E L P M E T N
N J E R U S A L E M

ALTAR

JESHUA

SHOUTED

CEDAR LOGS

LORD

TEMPLE

FOUNDATION

MERCY

THANKS

JERUSALEM

PRAISE

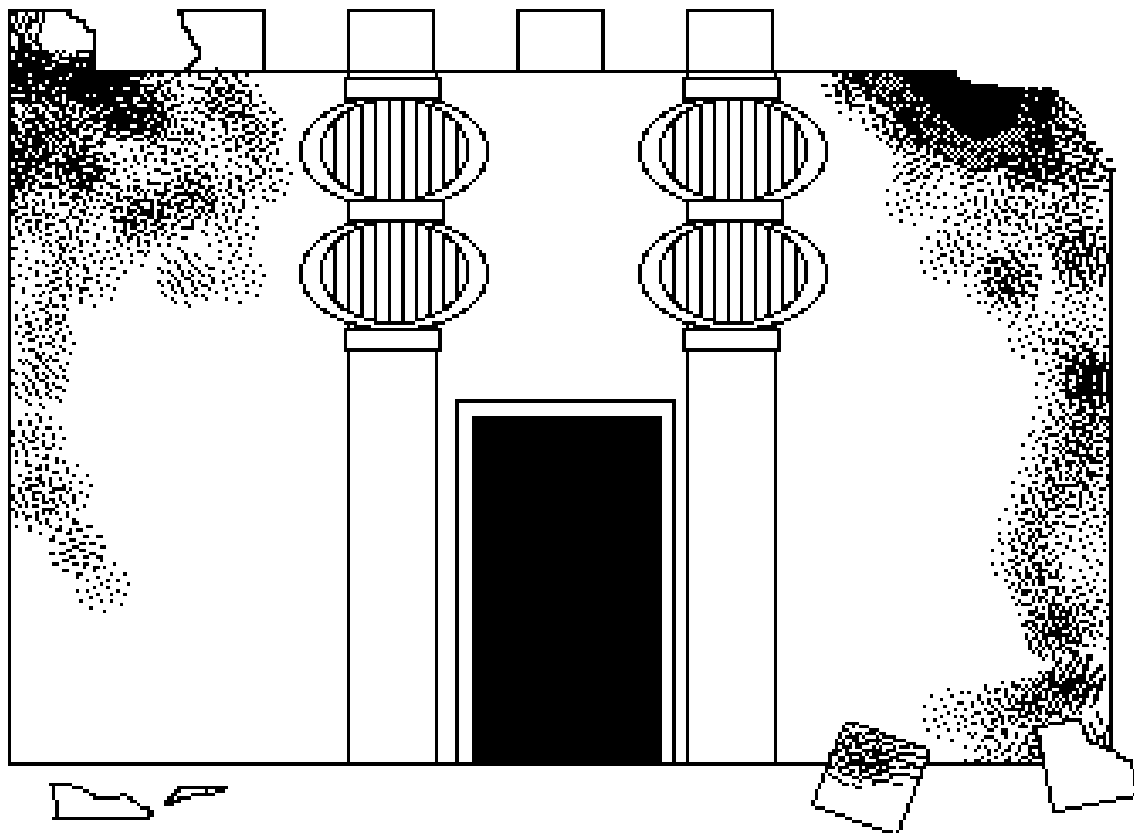

120. REBUILDING THE ALTAR AND THE TEMPLE

(EZRA 3:1-13)

MEMORY VERSE:

"Oh, give thanks to the LORD, for He is good! For His mercy endures forever."

PSALM 136:1

FILL IN THE BLANKS:

1. "The children of Israel were in the cities, the people gathered together as _____ to Jerusalem." **EZRA 3:1**
2. "Then Jeshua the son of Jozadak and his brethren the priests, and Zerubbabel the son of Shealtiel and his brethren, arose and built the _____ of the God of Israel, to offer burnt offerings on it, as it is written in the Law of Moses the man of God." **EZRA 3:2**

TRUE OR FALSE:

3. "The foundation of the temple of the LORD had not yet been laid." **EZRA 3:6**
TRUE OR FALSE

FILL IN THE BLANK:

4. "They also gave money to the masons and the carpenters, and food, drink, and oil to the people of Sidon and Tyre to bring cedar _____ from Lebanon to the sea at Joppa, according to the permission which they had _____ from Cyrus king of Persia." **EZRA 3:7**

TRUE OR FALSE:

5. "When the builders laid the foundation of the temple of the LORD, the priests stood in their apparel with trumpets, and the Levites, the sons of Asaph, with cymbals, to praise the LORD, according to the ordinance of David king of Israel." **EZRA 3:10**
TRUE OR FALSE

6. "And they sang responsively, praising and giving thanks to the LORD." **EZRA 3:11**
TRUE OR FALSE

FILL IN THE BLANKS:

7. "Then all the people _____ with a great shout, when they praised the LORD, because the foundation of the house of the LORD was _____." **EZRA 3:11**

TRUE OR FALSE:

8. And all of the priests and Levites and heads of the fathers' houses, who were old men, who had seen the first temple, rejoiced. **EZRA 3:12**
TRUE OR FALSE

120. REBUILDING THE ALTAR AND THE TEMPLE

(EZRA 3;1-13)

J E R U S A L E M K O V O C R
 N R H L P D C E D A R L O G S
 E I R H Q F S G W E V N T R I
 B Y A B L N Z P B O M V H H V
 P S T D E H O N R J G M K A V
 U Y L R B L R I V A D U U N T
 U D A O A D O W T S I H W N L
 R Y H L B I J T B A S S W V C
 J B B K B P M H S E D O E B M
 Z O N K U E L A J H O N R R W
 F J B W R M L N H Z O W U B B
 J C T C E W A K C N T U L O M
 F V Y D Z L G S O W B M T Z F
 E G L O R G H B Y I U G R E P
 O W Y F K T E M P L E Q Q L D

ALTAR	JESHUA	SHOUTED
CEDAR LOGS	LORD	TEMPLE
FOUNDATION	MERCY	THANKS
JERUSALEM	PRAISE	ZERUBBABEL

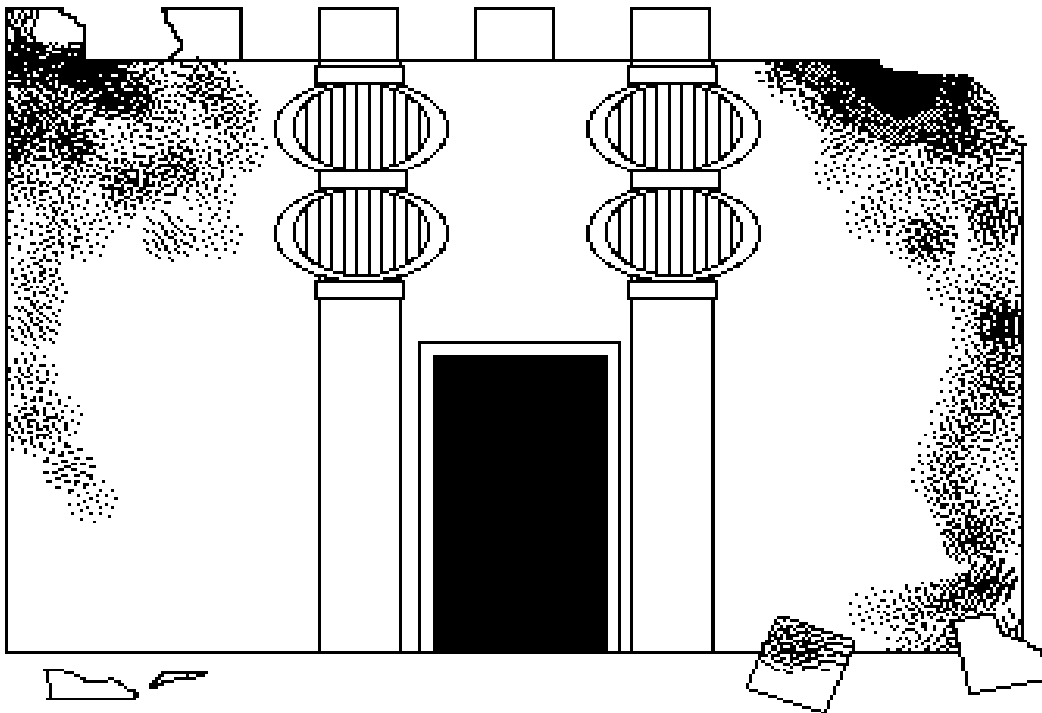

120. REBUILDING THE ALTAR AND THE TEMPLE

(EZRA 3:1-13)

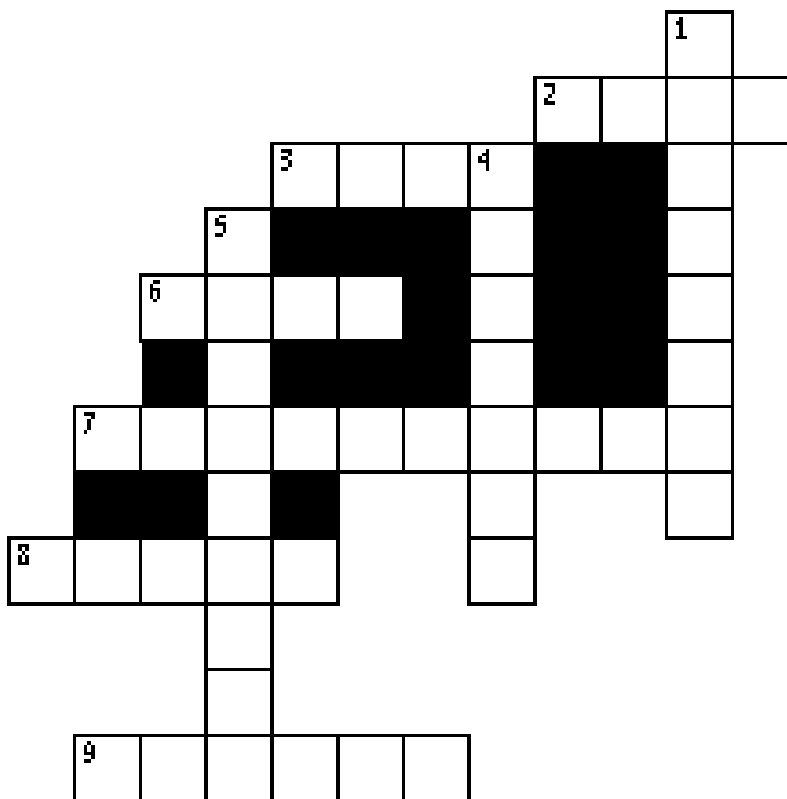

- 2 ACROSS "Oh, give thanks to the _____, for He is good! For His mercy endures forever." **PSALM 136:1**
- 5 DOWN "The children of Israel were in the cities, the people gathered together as one man to _____." **EZRA 3:1**
- 8 ACROSS "Then Jeshua the son of Jozadak and his brethren the priests, and Zerubbabel the son of Shealtiel and his brethren, arose and built the _____ of the God of Israel, to offer burnt offerings on it, as it is written in the Law of Moses the man of God." **EZRA 3:2**
- 7 ACROSS "The _____ of the temple of the LORD had not yet been laid." **EZRA 3:6**
- 3 ACROSS "They also gave money to the masons and the carpenters, and food, drink, and oil to the people of Sidon and Tyre to bring cedar _____ from Lebanon to the sea at Joppa, according to the permission which they had from Cyrus king of Persia." **EZRA 3:7**
- 9 ACROSS "When the builders laid the foundation of the _____ of the LORD, the priests stood in their apparel with trumpets, and the Levites, the sons of Asaph, with cymbals, to praise the LORD, according to the ordinance of David king of Israel." **EZRA 3:10**
- 1 DOWN "And they sang responsively, _____ and giving thanks to the LORD." **EZRA 3:11**
- 4 DOWN "Then all the people _____ with a great shout, when they praised the LORD, because the foundation of the house of the LORD was laid." **EZRA 3:11**
- 6 ACROSS "But many of the priests and Levites and heads of the fathers' houses, who were old men, who had seen the first temple, _____ with a loud voice." **EZRA 3:12**

Bible Story 121

THE OPPOSITION OF REBUILDING

EZRA 4:1-24

121. THE OPPOSITION OF REBUILDING

(EZRA 4:1-24)



"Now when the copy of King Artaxerxes' letter was read before Rehum, Shimshai the scribe, and their companions, they went up in haste to Jerusalem against the Jews, and by force of arms made them cease."

EZRA 4:23

121. THE OPPOSITION OF REBUILDING

(EZRA 4:1-24)

MEMORY VERSE:

"Now when the copy of King Artaxerxes' letter was read before Rehum, Shimshai the scribe, and their companions, they went up in haste to Jerusalem against the Jews, and by force of arms made them cease." EZRA 4:23

CIRCLE THE CORRECT WORDS:

1. "Now when the (**FRIENDS, ADVERSARIES**) of Judah and Benjamin heard that the descendants of the captivity were building the temple of the LORD God of Israel, they came to Zerubbabel and the heads of the fathers' houses, and said to them, 'Let us build with you, for we seek your God as you do; and we have sacrificed to Him since the days of Esarhaddon king of Assyria, who brought us here.' " **EZRA 4:1-2**
2. "But Zerubbabel and Jeshua and the rest of the heads of the fathers' houses of Israel said to them, 'You may do (**NOTHING, EVERYTHING**) with us to build a house for our God; but we alone will build to the LORD God of Israel, as King Cyrus the king of Persia has commanded us.' " **EZRA 4:3**

TRUE OR FALSE:

3. "Then the people of the land tried to discourage the people of Judah." **EZRA 4:4**
TRUE OR FALSE
4. They helped them in the building. **EZRA 4:4**
TRUE OR FALSE

CIRCLE THE CORRECT WORD:

5. They "hired counselors against them to (**FURTHER, FRUSTRATE**) their purpose all the days of Cyrus king of Persia, even until the reign of Darius king of Persia." **EZRA 4:5**

TRUE OR FALSE:

6. "Now in the reign of Ahasuerus, in the beginning of his reign, they wrote an accusation against the inhabitants of Judah and Jerusalem." **EZRA 4:6**
TRUE OR FALSE

CIRCLE THE CORRECT WORD:

7. "Now when the copy of King Artaxerxes' letter was read before Rehum, Shimshai the scribe, and their companions, they went up in haste to Jerusalem against the Jews, and by force of arms made them (**CONTINUE, CEASE**)." **EZRA 4:23**

TRUE OR FALSE:

8. Thus the work of the house of God which is at Jerusalem continued without any problems. **EZRA 4:24**

TRUE OR FALSE

121. THE OPPOSITION OF REBUILDING

(EZRA 4:1-24)

J A P P X D W S S I A W V B H
 E Z C R V O T E M P L E E W M
 S S Z E T O D Y O U I J Z Y G
 H D C M O S R O L E S N U O C
 U G M H L J E R U S A L E M H
 A P E Y J E K M E H P V U A C
 B C G Y Q K B F Z I Q H D U E
 L V A M L P A A P P F U P K A
 A U R B P Z G L B K J Y I Y S
 E I U P V S S K E B R G M H E
 Z P O R N O I T A S U C C A Q
 C N C Y G T A I U R C R Q F W
 L S S B U I L D I N G M E Q G
 W C I R Y V U Q V E G M B Z X
 C N D E Q G N S F N O U V X W

ACCUSATION
 BUILDING
 CEASE
 COUNSELORS

DISCOURAGE
 JERUSALEM
 JESHUA

JUDAH
 TEMPLE
 ZERUBBABEL

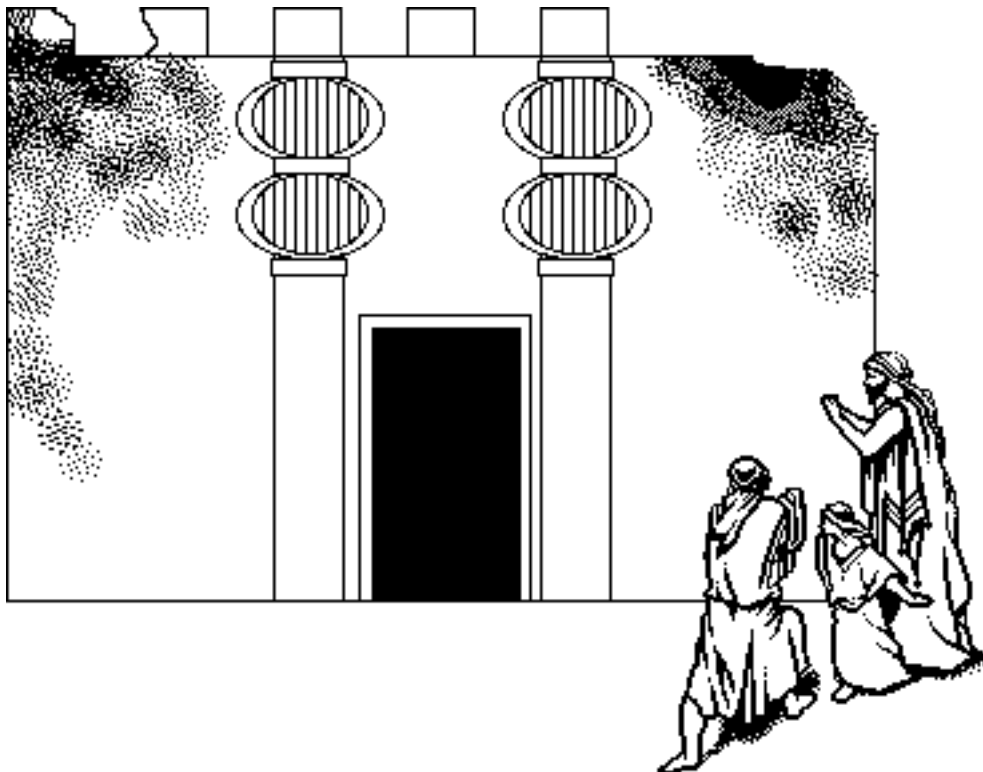

121. THE OPPOSITION OF REBUILDING

(EZRA 4:1-24)

MEMORY VERSE:

"Now when the copy of King Artaxerxes' letter was read before Rehum, Shimshai the scribe, and their companions, they went up in haste to Jerusalem against the Jews, and by force of arms made them cease." EZRA 4:23

FILL IN THE BLANKS:

1. "Now when the _____ of Judah and Benjamin heard that the descendants of _____ the captivity were building the temple of the LORD God of Israel, they came to Zerubbabel and the heads of the fathers' houses, and said to them, 'Let us build with you, for we seek your God as you do; and we have sacrificed to Him since the days of Esarhaddon king of Assyria, who brought us here.' " **EZRA 4:1-2**
2. "But Zerubbabel and Jeshua and the rest of the heads of the fathers' houses of Israel said to them, 'You may do _____ with us to build a house for our God; but we alone will build to the LORD God of Israel, as King Cyrus the king of Persia has commanded us.' " **EZRA 4:3**

TRUE OR FALSE:

3. "Then the people of the land tried to discourage the people of Judah." **EZRA 4:4**
TRUE OR FALSE
4. They helped them in the building. **EZRA 4:4**
TRUE OR FALSE

FILL IN THE BLANK:

5. They "hired counselors against them to _____ their purpose all the days of _____ Cyrus king of Persia, even until the reign of Darius king of Persia." **EZRA 4:5**

TRUE OR FALSE:

6. "Now in the reign of Ahasuerus, in the beginning of his reign, they wrote an accusation against the inhabitants of Judah and Jerusalem." **EZRA 4:6**
TRUE OR FALSE

FILL IN THE BLANK:

7. "Now when the copy of King Artaxerxes' letter was read before Rehum, Shimshai the scribe, and their companions, they went up in haste to Jerusalem against the Jews, and by force of arms made them _____." **EZRA 4:23**

TRUE OR FALSE:

8. Thus the work of the house of God which is at Jerusalem continued without any problems. **EZRA 4:24**
TRUE OR FALSE

121. THE OPPOSITION OF REBUILDING (EZRA 4:1-24)

Y F N N F N T G E D S G Y T J M G H U J
 D X T C D O C L M E L A S U R E J C I J
 O V M B D H P X W A S J E A M K Q G N E
 W W L F V M N V V U O J A L H F V D T S
 S Q N O E M P S Z Q I H O S O G Y J O H
 R T T T D Z L S Z C B V I K P N H D A U
 Z C N V E S A E C N K F Y J D I W O Z A
 B Y H O M D O F B L G O W L E D N F H Y
 C N T M I C J A M A L P Y R C L O S Q K
 H K P T V T T V M B B U M Q K I A R W N
 J K D F P V A S M C O B R C W U R O I F
 L W I W T E Z S I E M U U O C B N L Y Z
 E I S Y I K D W U O L R L R W S T E M M
 O J C F H N E A M C T D Z C E Q W S H S
 O Q O E N Z E W O W C Y I G O Z X N W J
 W L U D N B D W J P T A D C E V A U N U
 J H R R S O C Z U Y J M U C U H N O E D
 A U A L K R C O B V T D K L U K P C L A
 G G G B Y B L X O Z H P L T E P M W I H
 F I E H L B G A B N H X R E H W Y D Z W

ACCUSATION
 BUILDING
 CEASE
 COUNSELORS

DISCOURAGE
 JERUSALEM
 JESHUA

JUDAH
 TEMPLE
 ZERUBBABEL

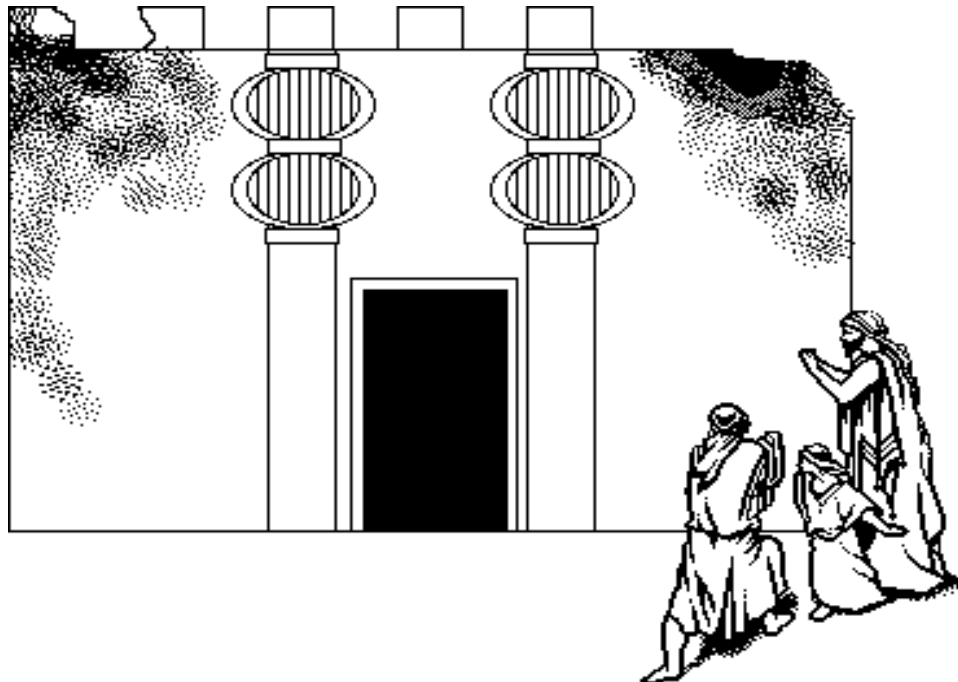

121. THE OPPOSITION OF REBUILDING

(EZRA 4:1-24)

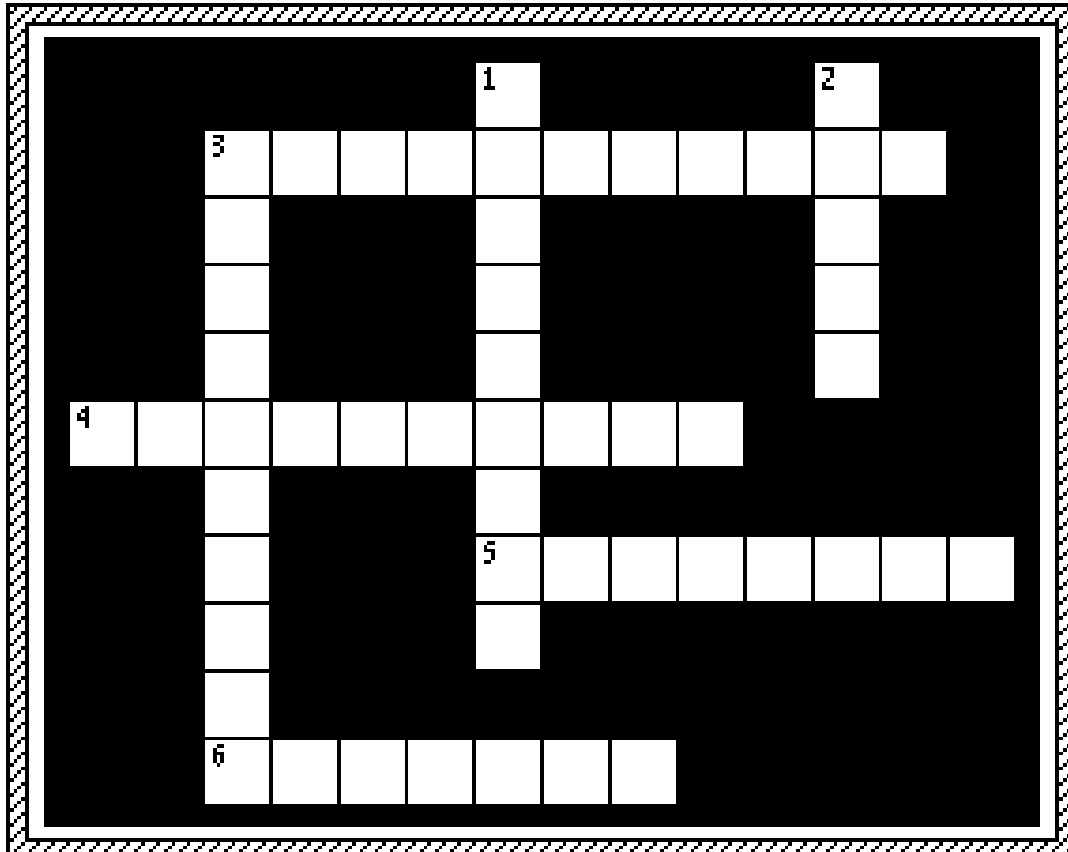

- 3 ACROSS "Now when the ____ of Judah and Benjamin heard that the descendants of the captivity were building the temple of the LORD God of Israel, they came to Zerubbabel and the heads of the fathers' houses, and said to them, 'Let us build with you, for we seek your God as you do; and we have sacrificed to Him since the days of Esarhaddon king of Assyria, who brought us here.' " **EZRA 4:1-2**
- 6 ACROSS "But Zerubbabel and Jeshua and the rest of the heads of the fathers' houses of Israel said to them, 'You may do ____ with us to build a house for our God; but we alone will build to the LORD God of Israel, as King Cyrus the king of Persia has commanded us.' " **EZRA 4:3**
- 4 ACROSS "Then the people of the land tried to ____ the people of Judah." **EZRA 4:4**
- 5 ACROSS "They ____ them in building." **EZRA 4:4**
- 1 DOWN They "hired counselors against them to ____ their purpose all the days of Cyrus king of Persia, even until the reign of Darius king of Persia." **EZRA 4:5**
- 3 DOWN "Now in the reign of Ahasuerus, in the beginning of his reign, they wrote an ____ against the inhabitants of Judah and Jerusalem." **EZRA 4:6**
- 2 DOWN "Now when the copy of King Artaxerxes' letter was read before Rehum, Shimshai the scribe, and their companions, they went up in haste to Jerusalem against the Jews, and by force of arms made them ____." **EZRA 4:23**

Bible Story 122

**COMPLETION,
DEDICATION
OF THE TEMPLE**

EZRA 6:13-22

122. THE COMPLETION & DEDICATION OF THE TEMPLE

(EZRA 6:13-22)



"And this house was finished on the third day of the month Adar,
which was in the sixth year of the reign of Darius the king."

EZRA 6:15

122. THE COMPLETION & DEDICATION OF THE TEMPLE

(EZRA 6:13-22)

MEMORY VERSE:

"Then the children of Israel, the priests and the Levites and the rest of the descendants of the captivity, celebrated the dedication of this house of God with joy." EZRA 6:16

CIRCLE THE CORRECT WORDS:

1. "So the elders of the Jews (**BUILT, DESTROYED**), and they prospered through the prophesying of Haggai the prophet and Zechariah the son of Iddo." **EZRA 6:14**
2. "And they built and finished it, according to the commandment of the God of Israel, and according to the command of ____, ____, and ____." **EZRA 6:14**
CYRUS DARIUS BARIUS ARTAXERXES

TRUE OR FALSE:

3. Now the temple was not finished on the third day of the month of Adar, which was in the sixth year of the reign of King Darius. **EZRA 6:15**
TRUE OR FALSE

FILL IN THE BLANK:

4. "Then the children of Israel, the priests and the Levites and the rest of the descendants of the captivity, celebrated the dedication of this house of God with ____." **EZRA 6:16**

TRUE OR FALSE:

5. "They offered sacrifices at the dedication of this house of God." **EZRA 6:17**
TRUE OR FALSE
6. "And the descendants of the captivity kept the Passover on the fourteenth day of the first month." **EZRA 6:19**
TRUE OR FALSE

CIRCLE THE CORRECT WORDS:

7. "For the priests and the Levites had purified themselves; all of them were ritually (**CLEAN, UNCLEAN**)." **EZRA 6:20**
8. "Then the children of Israel who had returned from the captivity ate together with all who had separated themselves from the filth of the nations of the land in order to (**SEEK, LEAVE**) the LORD God of Israel." **EZRA 6:21**

TRUE OR FALSE:

9. "And they kept the Feast of Unleavened Bread seven days with joy; for the LORD made them joyful." **EZRA 6:22**
TRUE OR FALSE

122. THE COMPLETION & DEDICATION OF THE TEMPLE

(EZRA 6:13-22)

N	J	D	R	O	L	J	F	H	T
O	R	O	L	E	V	I	T	E	S
I	D	E	Y	F	N	F	M	O	B
T	C	A	V	I	I	P	J	K	U
A	F	D	S	O	L	B	M	Y	I
C	D	H	Q	E	S	G	S	J	L
I	E	P	R	I	E	S	T	S	T
D	H	M	C	O	M	M	A	N	D
E	H	T	C	H	D	B	P	P	N
D	P	N	A	Z	E	A	H	G	L

BUILT	JOY	PASSOVER
COMMAND	LEVITES	PRIESTS
DEDICATION	LORD	TEMPLE
FINISHED		

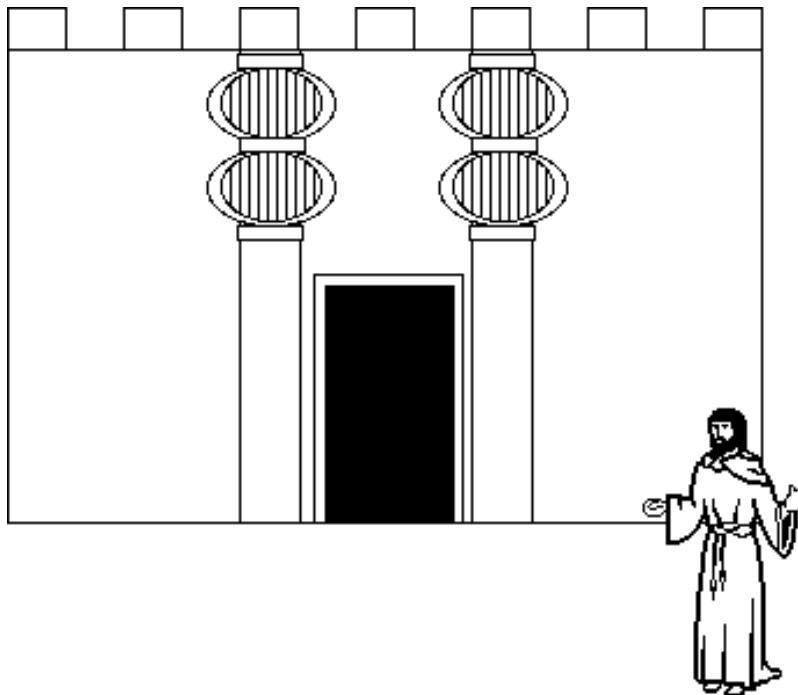

122. THE COMPLETION & DEDICATION OF THE TEMPLE

(EZRA 6:13-22)

MEMORY VERSE:

"Then the children of Israel, the priests and the Levites and the rest of the descendants of the captivity, celebrated the dedication of this house of God with joy." EZRA 6:16

FILL IN THE BLANK:

1. "So the elders of the Jews _____, and they prospered through the prophesying of Haggai the prophet and Zechariah the son of Iddo." **EZRA 6:14**

CIRCLE THE CORRECT WORDS:

2. "And they built and finished it, according to the commandment of the God of Israel, and according to the command of ____, ____, and ____." **EZRA 6:14**
CYRUS DARIUS BARIUS ARTAXERXES

TRUE OR FALSE:

3. Now the temple was not finished on the third day of the month of Adar, which was in the sixth year of the reign of King Darius. **EZRA 6:15**
TRUE OR FALSE

FILL IN THE BLANK:

4. "Then the children of Israel, the priests and the Levites and the rest of the descendants of the captivity, celebrated the dedication of this house of God with _____." **EZRA 6:16**

TRUE OR FALSE:

5. "They offered sacrifices at the dedication of this house of God." **EZRA 6:17**
TRUE OR FALSE
6. "And the descendants of the captivity kept the Passover on the fourteenth day of the first month." **EZRA 6:19**
TRUE OR FALSE

FILL IN THE BLANKS:

7. "For the priests and the Levites had purified themselves; all of them were ritually _____." **EZRA 6:20**
8. "Then the children of Israel who had returned from the captivity ate together with all who had separated themselves from the filth of the nations of the land in order to _____ the LORD God of Israel." **EZRA 6:21**
9. "And they kept the Feast of Unleavened Bread seven days with joy; for the _____ made them joyful." **EZRA 6:22**

122. THE COMPLETION & DEDICATION OF THE TEMPLE

(EZRA 6:13-22)

S P P L F O F B M Q U J V M E
 A U R Q E N D U C D O J Z V D
 C R I P A U E I R Y A A R O B
 R I E S S L D L I Q T R K V I
 I F S F T E I T P C N D I O Z
 F I T I N V C S Z Y E I E U F
 I E S N A I A E V R M O E F S
 C D N I D T T N P U D B L M A
 E Z K S N E I R A S N E D J K
 S Q P H E S O E S U A O E Y Q
 D B H E C O N M S S M N R T S
 R U Q D S P F A O D M R S N W
 O W O N E T Z T V E O L G H Y
 L D Z U D L R R E B C L I Q U
 V Y F D Z R U A R T E M P L E

TEMPLE
 BUILT
 COMMANDMENT
 CYRUS
 DARIUS
 DEDICATION

DESCENDANTS
 ELDERS
 FEAST
 FINISHED
 JOY
 LEVITES!

LORD
 PASSOVER
 PRIESTS
 PURIFIED
 SACRIFICES

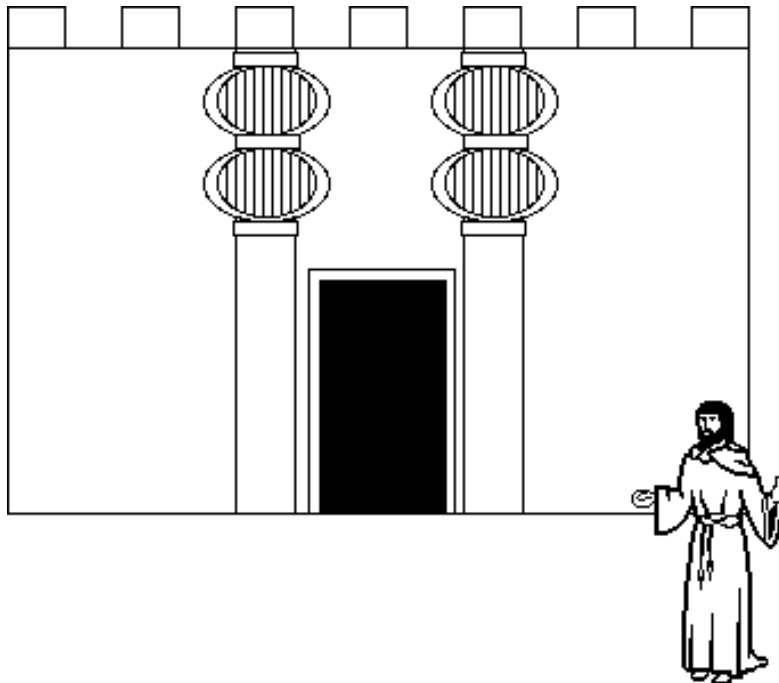

122. THE COMPLETION & DEDICATION OF THE TEMPLE (EZRA 6:13-22)

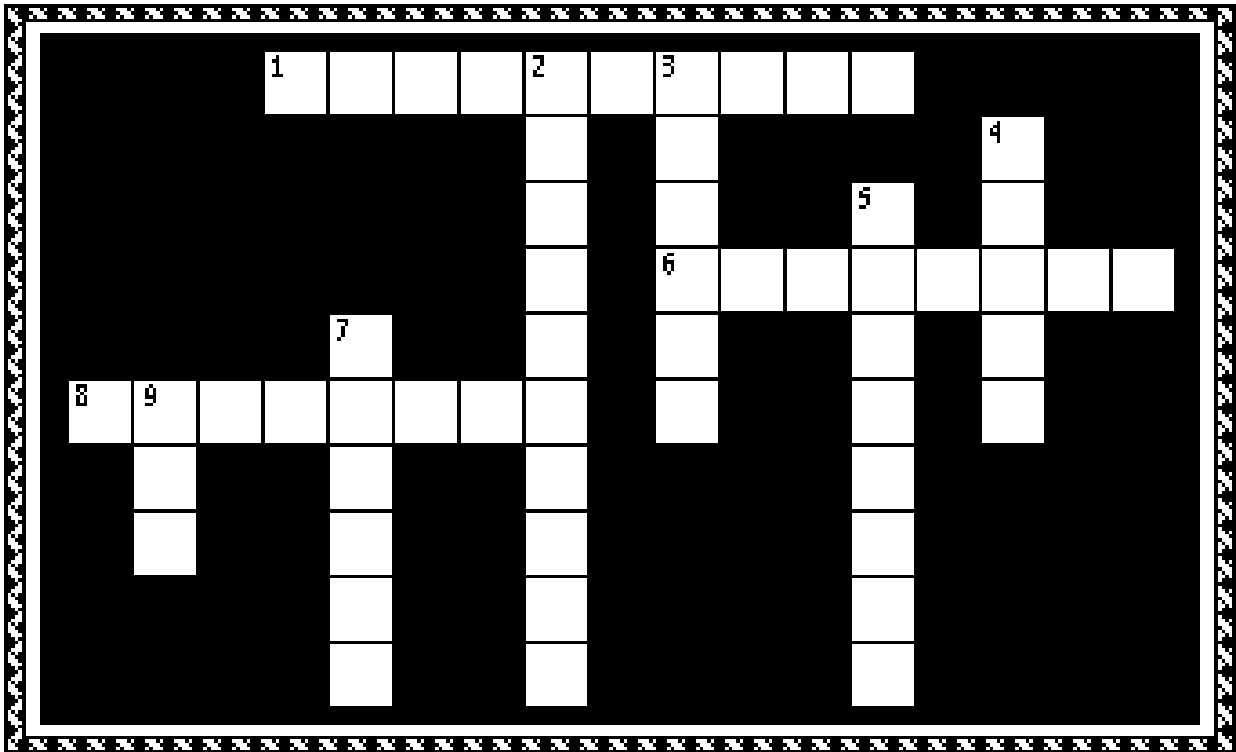

- 4 DOWN "So the elders of the Jews _____ and they prospered through the prophesying of Haggai the prophet and Zechariah the son of Iddo." **EZRA 6:14**
- 5 DOWN "And they built and _____ it, according to the commandment of the God of Israel, and according to the command of Cyrus, Darius, and Artaxerxes." **EZRA 6:14**
- 3 DOWN "Now the _____ was finished on the third day of the month of Adar, which was in the sixth year of the reign of King Darius." **EZRA 6:15**
- 2 DOWN "Then the children of Israel, the priests and the Levites and the rest of the descendants of the captivity, _____ the dedication of this house of God with joy." **EZRA 6:16**
- 1 ACROSS "They offered sacrifices at the _____ of this house of God." **EZRA 6:17**
- 8 ACROSS "And the descendants of the captivity kept the _____ on the fourteenth day of the first month." **EZRA 6:19**
- 6 ACROSS "For the priests and the Levites had _____ themselves; all of them were ritually clean." **EZRA 6:20**
- 9 DOWN "Then the children of Israel who had returned from the captivity _____ together with all who had separated themselves from the filth of the nations of the land in order to seek the LORD God of Israel." **EZRA 6:21**
- 7 DOWN "And they kept the Feast of Unleavened Bread seven days with joy; for the LORD made them _____." **EZRA 6:22**

Bible Story 123

**THE PEOPLE
CONFESS THEIR SIN**

EZRA 10:1-17

123. THE PEOPLE CONFESS THEIR SIN (EZRA 10:1-17)



"Now therefore, make confession to the LORD God of your fathers, and do His will; "
EZRA 10:11

123. THE PEOPLE CONFESS THEIR SIN

(EZRA 10:1-17)

MEMORY VERSE:

"Now therefore, make confession to the LORD God of your fathers, and do His will; separate yourselves from the peoples of the land." EZRA 10:11

CIRCLE THE CORRECT WORDS:

1. "Now while Ezra was (**PRAYING, LAYING**), and while he was (**ADDRESSING, CONFESSING**), (**SLEEPING, WEEPING**), and (**BOWING, SOWING**) down before the house of God, a very large congregation of men, women, and children assembled to him from Israel; for the people wept very bitterly." **EZRA 10:1**

UNDERLINE THE CORRECT ANSWER:

2. "Then Ezra rose up from before the house of God, and went into the chamber of Jehohanan the son of Eliashib; and when he came there..." **EZRA 10:6**
- a. he ate no bread
 - b. he drank no water
 - c. he mourned because of the guilt of those from the captivity
 - d. all of the above

TRUE OR FALSE:

3. "They issued a proclamation throughout Judah and Jerusalem to all the descendants of the captivity, that they must gather at Jerusalem." **EZRA 10:7**

TRUE OR FALSE

4. "All the people sat in the open square of the house of God, trembling because of this matter and because of heavy rain." **EZRA 10:9**

TRUE OR FALSE

CIRCLE THE CORRECT WORDS:

5. "Then Ezra the priest stood up and said to them, 'You have transgressed and have taken (**PAGAN, GODLY**) wives, adding to the guilt of Israel.'" **EZRA 10:10**
6. "Now therefore, make (**CONFESSION, CONFUSION**) to the LORD God of your fathers, and do His will; separate yourselves from the peoples of the land, and from the pagan wives." **EZRA 10:11**

TRUE OR FALSE:

7. Then all the congregation answered and said with a loud voice, "No! As you have said, we will not do." **EZRA 10:12**

TRUE OR FALSE

CIRCLE THE CORRECT WORD(S):

8. They said, "Please, let the leaders of our entire congregation stand; and let all those in our cities who have taken pagan wives come at appointed times, together with the elders and judges of their cities, until the fierce wrath of our God is turned (**AWAY FROM, TOWARD**) us in the matter." **EZRA 10:14**

TRUE OR FALSE:

9. "By the first day of the month they finished questioning all the men who had taken pagan wives." **EZRA 10:17**

TRUE OR FALSE

123. THE PEOPLE CONFESS THEIR SIN (EZRA 10:1-17)

Q C O N F E S S I N G
P U L M Y E U S D M D
A R E O M H W G W O Y
G B F S D T N V G U S
A U O I T I Q N T R M
N W L W Y I I U L N U
W N R A I P O U A E D
I U R A E N N N O D O
V P Y E T L G Q I P G
E D W R F H I L A N X
S L H F B E Z R A A G

BOWING
CONFESSING
EZRA
GOD

MOURNED
PAGAN WIVES
PRAYING

QUESTIONING
WEEPING
WRATH

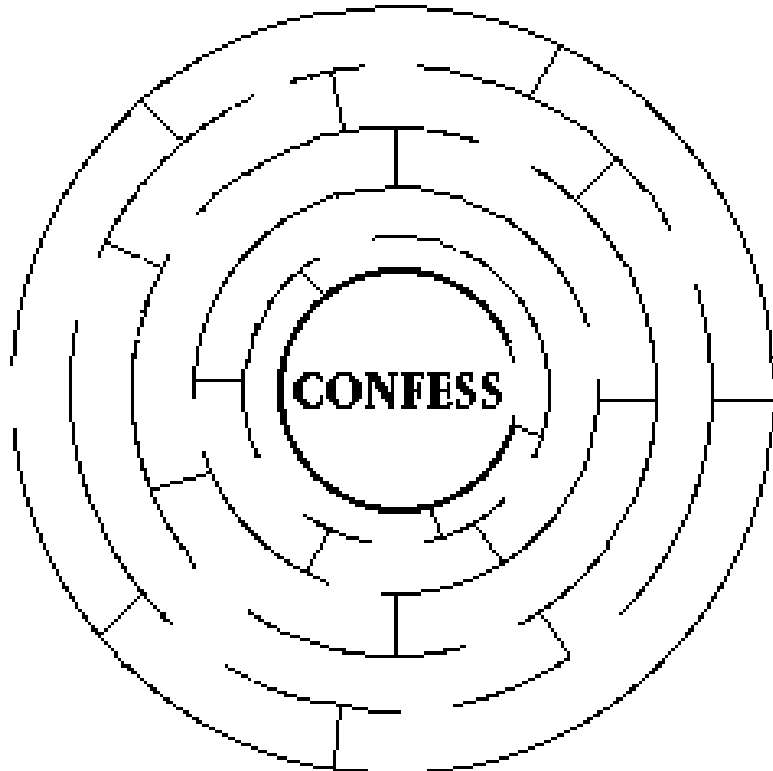

123. THE PEOPLE CONFESS THEIR SIN

(EZRA 10:1-17)

MEMORY VERSE:

"Now therefore, make confession to the LORD God of your fathers, and do His will; separate yourselves from the peoples of the land." EZRA 10:11

FILL IN THE BLANKS:

1. "Now while Ezra was _____, and while he was _____, _____, and _____ down before the house of God, a very large congregation of men, women, and children assembled to him from Israel; for the people wept very bitterly." EZRA 10:1

UNDERLINE THE CORRECT ANSWER:

2. "Then Ezra rose up from before the house of God, and went into the chamber of Jehohanan the son of Eliashib; and when he came there..." EZRA 10:6
- he ate no bread
 - he drank no water
 - he mourned because of the guilt of those from the captivity
 - all of the above

TRUE OR FALSE:

3. "They issued a proclamation throughout Judah and Jerusalem to all the descendants of the captivity, that they must gather at Jerusalem." EZRA 10:7

TRUE OR FALSE

4. "All the people sat in the open square of the house of God, trembling because of this matter and because of heavy rain." EZRA 10:9

TRUE OR FALSE

FILL IN THE BLANKS:

5. "Then Ezra the priest stood up and said to them, 'You have transgressed and have taken _____ wives, adding to the guilt of Israel.' " EZRA 10:10
6. "Now therefore, make _____ to the LORD God of your fathers, and do His will; separate yourselves from the peoples of the land, and from the pagan wives." EZRA 10:11

TRUE OR FALSE:

7. Then all the congregation answered and said with a loud voice, "No! As you have said, we will not do." EZRA 10:12

TRUE OR FALSE

FILL IN THE BLANKS:

8. They said, "Please, let the leaders of our entire congregation stand; and let all those in our cities who have taken pagan wives come at appointed times, together with the elders and judges of their cities, until the fierce _____ of our God is turned away from us in the matter." EZRA 10:14

TRUE OR FALSE:

9. "By the first day of the month they finished questioning all the men who had taken pagan wives." EZRA 10:17

TRUE OR FALSE

123. THE PEOPLE CONFESS THEIR SIN (EZRA 10:1-17)

W H E L B P N T V W C J E A Q
 E U O D Z H V B Q X Q B F N R
 E Q O R F Z Q I Z P I B J D I
 P S C E H I G N I Y A R P E L
 I S G N I S S E F N O C T N S
 N I F U N V T A U E W R E R T
 G L N W G V A M A S Z B J U F
 J S B J N B Q M N G K K Z O A
 Q G N I N O I T S E U Q Z M Y
 I J Y N G Q F T M D K G K R Y
 K F H T A R W Y G E Q N C P G
 T F N S R Y H L F P A I T I O
 P A G A N W I V E S R W I Q D
 D O M Z Q E P I H Z Z O O D O
 Y P H K I L J O A C E B T J F

BOWING
 CONFESSING
 EZRA
 GOD

MOURNED
 PAGAN WIVES
 PRAYING

QUESTIONING
 WEEPING
 WRATH

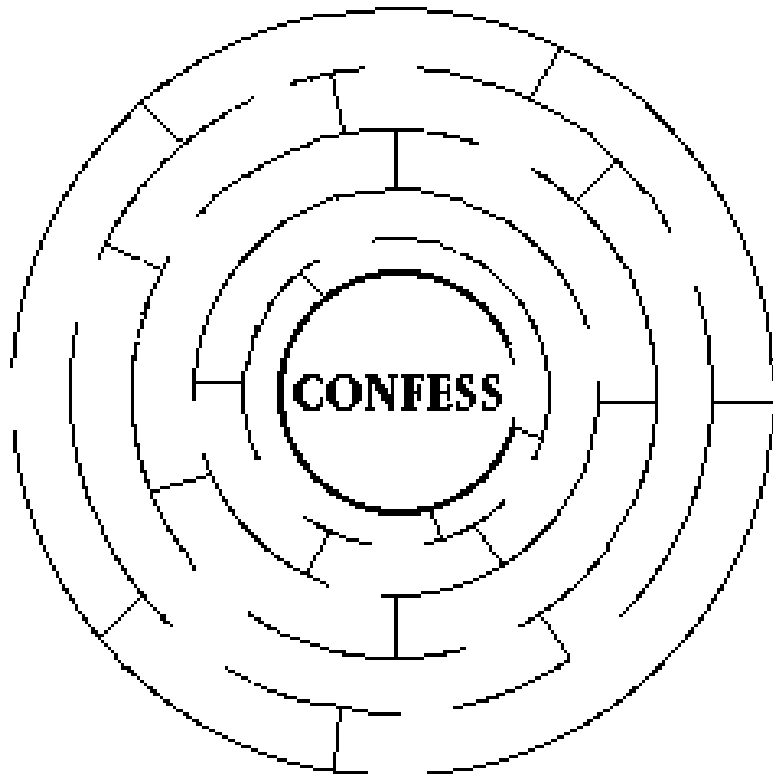

123. THE PEOPLE CONFESS THEIR SIN (EZRA 10:1-17)

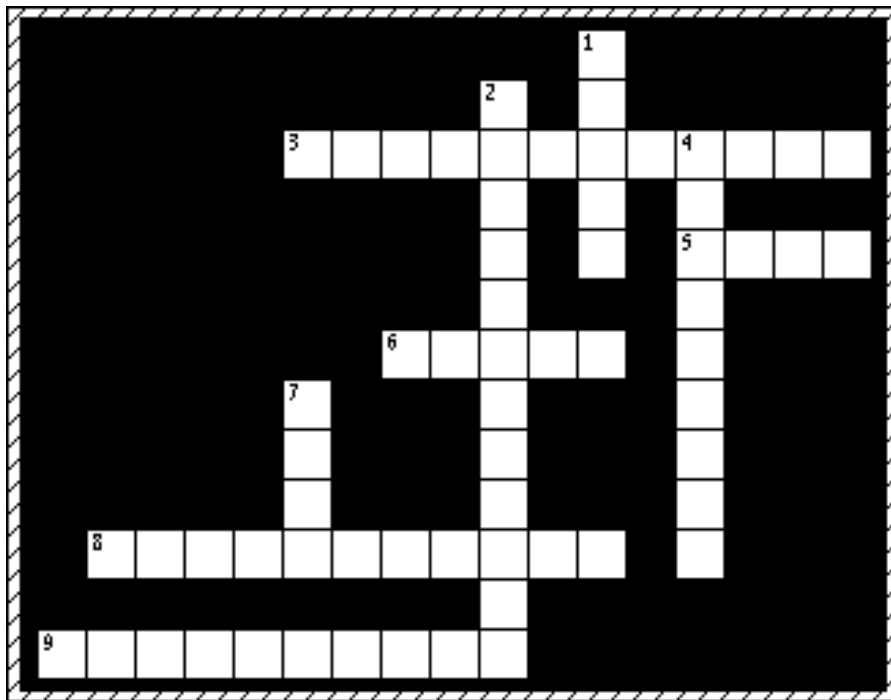

- 7 DOWN "Now while Ezra was praying, and while he was confessing, weeping, and bowing down before the house of God, a very large congregation of men, women, and children assembled to him from Israel; for the people _____ very bitterly." **EZRA 10:1**
- 5 ACROSS "Then _____ rose up from before the house of God, and went into the chamber of Jehohanan the son of Eliashib." **EZRA 10:6**
- 2 DOWN "They issued a _____ throughout Judah and Jerusalem to all the descendants of the captivity, that they must gather at Jerusalem." **EZRA 10:7**
- 4 DOWN "All the people sat in the open square of the house of God, _____ because of this matter and because of heavy rain." **EZRA 10:9**
- 1 DOWN "Then Ezra the priest stood up and said to them, 'You have transgressed and have taken _____ wives, adding to the guilt of Israel.' " **EZRA 10:10**
- 9 DOWN "Now therefore, make _____ to the LORD God of your fathers, and do His will; separate yourselves from the peoples of the land, and from the pagan wives." **EZRA 10:11**
- 3 ACROSS "Then all the _____ answered and said with a loud voice, 'Yes! As you have said, so we must do.' " **EZRA 10:12**
- 6 ACROSS They said, "Please, let the leaders of our entire congregation stand; and let all those in our cities who have taken pagan wives come at appointed times, together with the elders and judges of their cities, until the fierce _____ of our God is turned away from us in the matter." **EZRA 10:14**
- 8 ACROSS "By the first day of the month they finished _____ all the men who had taken pagan wives." **EZRA 10:17**

Bible Story 124

**NEHEMIAH'S
PRAYER &
VIEWING
OF THE WALL**

NEHEMIAH 1:1-2:20

124. NEHEMIAH'S PRAYER & VIEWING THE WALL (NEHEMIAH 1:1-2:20)



"O Lord, I pray, please let Your ear be attentive to the prayer of Your servant, and to the prayer of Your servants who desire to fear Your name." **NEHEMIAH 1:11**

124. NEHEMIAH'S PRAYER & VIEWING THE WALL

(NEHEMIAH 1:1-2:20)

MEMORY VERSE:

"O Lord, I pray, please let Your ear be attentive to the prayer of Your servant, and to the prayer of Your servants who desire to fear Your name." NEHEMIAH 1:11

TRUE OR FALSE:

1. Nehemiah asked about "the Jews who had escaped, who had survived the captivity, and concerning Jerusalem." NEHEMIAH 1:2

TRUE OR FALSE

2. And they said to him, "All is well with the survivors. The walls of Jerusalem are tall, and the gates are strong." NEHEMIAH 1:3

TRUE OR FALSE

CIRCLE THE CORRECT WORDS:

3. Nehemiah said, "So it was, when I heard these words, that I sat down and wept, and mourned for many days; I was (**CASTING**, **FASTING**) and (**PRAYING**, **SAYING**) before the God of heaven." NEHEMIAH 1:4

TRUE OR FALSE:

4. Nehemiah was the king's cupbearer. NEHEMIAH 1:11

TRUE OR FALSE

CIRCLE THE CORRECT WORDS:

5. "The king said to me, 'Why is your face (**HAPPY**, **SAD**), since you are not sick? This is nothing but sorrow of heart.' Then I became dreadfully afraid, and said to the king, 'May the king live forever! Why should my face not be (**HAPPY**, **SAD**), when the city, the place of my fathers' tombs, lies waste, and its gates are burned with fire?' " NEHEMIAH 2:2-3

6. "Then the king said to me, 'What do you request?' So I (**PRAYED**, **STAYED**) to the God of heaven. And I said to the king, 'If it pleases the king, and if your servant has found favor in your sight, I ask that you send me to Judah, to the city of my fathers' tombs, that I might (**REBURN**, **REBUILD**) it.' " NEHEMIAH 2:4-5

7. "Furthermore I said to the king, 'If it pleases the king, let (**GOLD**, **LETTERS**) be given to me for the governors of the region beyond the River, that they must permit me to pass through till I come to Judah, and a letter to Asaph the keeper of the king's forest, that he must give me (**TIMBER**, **CYMBALS**) to make beams for the gates of the citadel which pertains to the temple, for the city wall, and for the house that I will occupy.' " NEHEMIAH 2:7-8

TRUE OR FALSE:

8. Nehemiah writes, "So I came to Jerusalem and was there three days." NEHEMIAH 2:11

TRUE OR FALSE

9. He writes, "I went out by night through the Valley Gate to the Serpent Well and the Refuse Gate, and viewed the walls of Jerusalem which were broken down and its gates which were burned with fire." NEHEMIAH 2:14

TRUE OR FALSE

FILL IN THE BLANKS:

10. Nehemiah told the officials "of the hand of my God which had been good upon me, and also of the king's words that he had spoken to me. So they said, 'Let us rise up and build.' Then they set their _____ to do this good _____." NEHEMIAH 2:18

124. NEHEMIAH'S PRAYER & VIEWING THE WALL (NEHEMIAH 1:1-2:20)

S L L A W V G O D U O O N D D
 L G A N H Q S L G R R J B O I
 M N K P G D H L I J I N U F P
 S I I M H M P N C Z Y V L M M
 O K Y N A D E N N F S G Y Q W
 A L T Q I D P L D E N R U B L
 L S F Q M V R Z A N Y W L R G
 K V Z H E F S S E S D H H K S
 N S A D H R A K P J U D V S Z
 M P B V E V O S E R L R E D R
 G Z C T N R B V T I A T E F O
 G S T Z B D N M U I A Y K J J
 T E S U U W G B B G N H I H L
 L M L D Q R E O P F Y G K N L
 E B S F J R B N U E B B M L G

BROKEN
 BURNED
 FASTING
 GATES
 GOD

JERUSALEM
 KING
 LETTERS
 NEHEMIAH

PRAYING
 REBUILD
 SAD
 WALLS

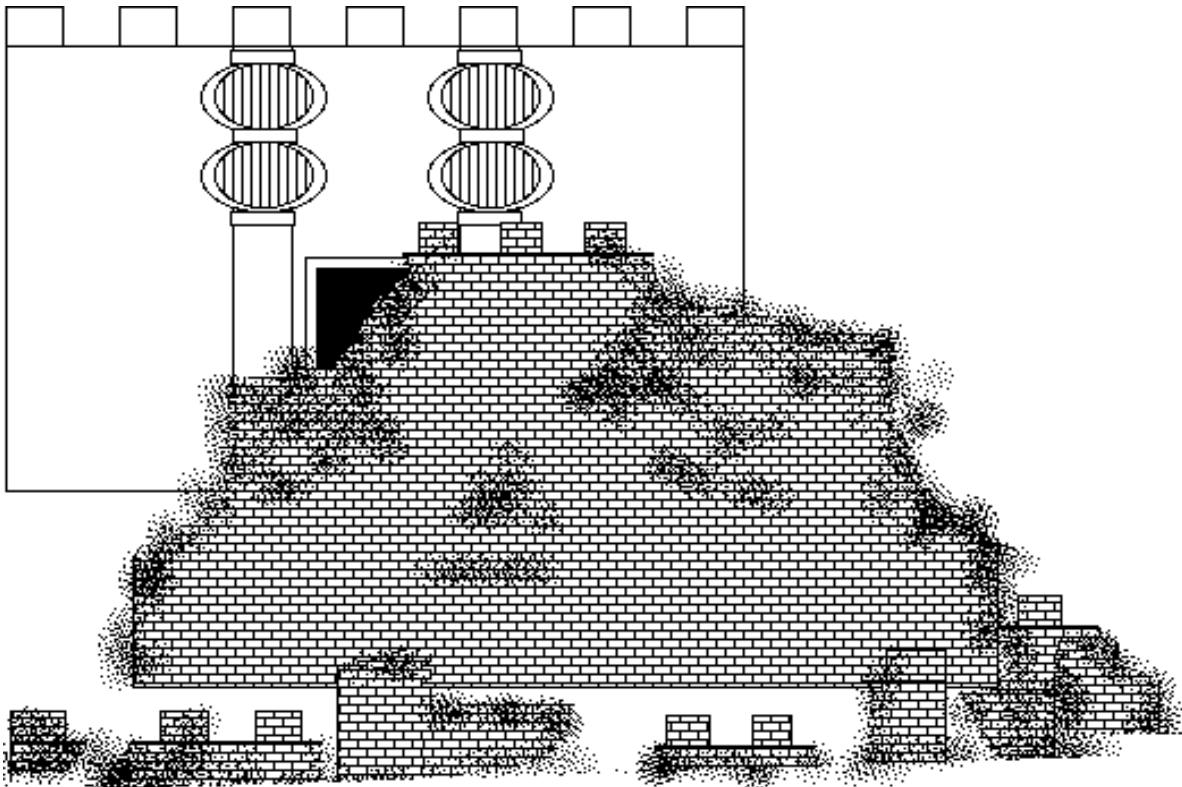

124. NEHEMIAH'S PRAYER & VIEWING THE WALL

(NEHEMIAH 1:1-2:20)

MEMORY VERSE:

"O Lord, I pray, please let Your ear be attentive to the prayer of Your servant, and to the prayer of Your servants who desire to fear Your name." NEHEMIAH 1:11

TRUE OR FALSE:

1. Nehemiah asked about "the Jews who had escaped, who had survived the captivity, and concerning Jerusalem." NEHEMIAH 1:2

TRUE OR FALSE

2. And they said to him, "All is well with the survivors. The walls of Jerusalem are tall, and the gates are strong." NEHEMIAH 1:3

TRUE OR FALSE

FILL IN THE BLANKS:

3. Nehemiah said, "So it was, when I heard these words, that I sat down and wept, and mourned for many days; I was _____ and _____ before the God of heaven." NEHEMIAH 1:4

TRUE OR FALSE:

4. Nehemiah was the king's cupbearer. NEHEMIAH 1:11

TRUE OR FALSE

FILL IN THE BLANKS:

5. "The king said to me, 'Why is your face _____, since you are not sick? This is nothing but sorrow of heart.' Then I became dreadfully afraid, and said to the king, 'May the king live forever! Why should my face not be _____, when the city, the place of my fathers' tombs, lies waste, and its gates are burned with fire?' " NEHEMIAH 2:2-3

6. "Then the king said to me, 'What do you request?' So I _____ to the God of heaven. And I said to the king, 'If it pleases the king, and if your servant has found favor in your sight, I ask that you send me to Judah, to the city of my fathers' tombs, that I might _____ it.' " NEHEMIAH 2:4-5

7. "Furthermore I said to the king, 'If it pleases the king, let _____ be given to me for the governors of the region beyond the River, that they must permit me to pass through till I come to Judah, and a letter to Asaph the keeper of the king's forest, that he must give me _____ to make beams for the gates of the citadel which pertains to the temple, for the city wall, and for the house that I will occupy.' " NEHEMIAH 2:7-8

TRUE OR FALSE:

8. Nehemiah writes, "So I came to Jerusalem and was there three days." NEHEMIAH 2:11

TRUE OR FALSE

9. He writes, "I went out by night through the Valley Gate to the Serpent Well and the Refuse Gate, and viewed the walls of Jerusalem which were broken down and its gates which were burned with fire." NEHEMIAH 2:14

TRUE OR FALSE

FILL IN THE BLANKS:

10. Nehemiah told the officials "of the hand of my God which had been good upon me, and also of the king's words that he had spoken to me. So they said, 'Let us rise up and build.' Then they set their _____ to do this good _____." NEHEMIAH 2:18

124. NEHEMIAH'S PRAYER & VIEWING THE WALL (NEHEMIAH 1:1-2:20)

D F E Q E I G C E R V W W R S B K P F P
 Y D L I U B E R F P W L Y C Z M P L S E
 H O U G L A F Q J I S F G G F L Z J W V
 U P W R N M H I T Q V A P N P B Y C U A
 Q E J Q V H A W E D M S Z R I N Y V D R
 S O S R E T T E L J A T W G G Y O T S L
 S O N I Q T W Z J Q Z I B N K A A W J W
 I C G P T Y N K Z R S N M G B C J R H J
 L F S O A L S K Z I H G W Z U W F H P U
 B D Z H D I P A K L B Z U J P J A P Q O
 U B K Z Q O E Q D S M R F P C H H J O E
 R M E L A S U R E J B B O N N L A S E P
 N Y B I F V S J C T S P I K M O L H W T
 E N Z V H Q G B T F V J N U E L H Q E C
 D M F V P Z D G I A O H G O A N Z O B S
 S H H B J U E B N Y J G Y W D I D A B C
 N E H E M I A H O I J E P F L T Y O S H
 S L T Q T A P R T Y K U Y L S E N W W U
 J D N A B N Z B A O E W B L V J J V U N
 F R G B G M C N N L A D D M R K T M H E

BROKEN DOWN
 BURNED
 FASTING
 GATES
 GOD

JERUSALEM
 KING
 LETTERS
 NEHEMIAH

PRAYING
 REBUILD
 SAD
 WALLS

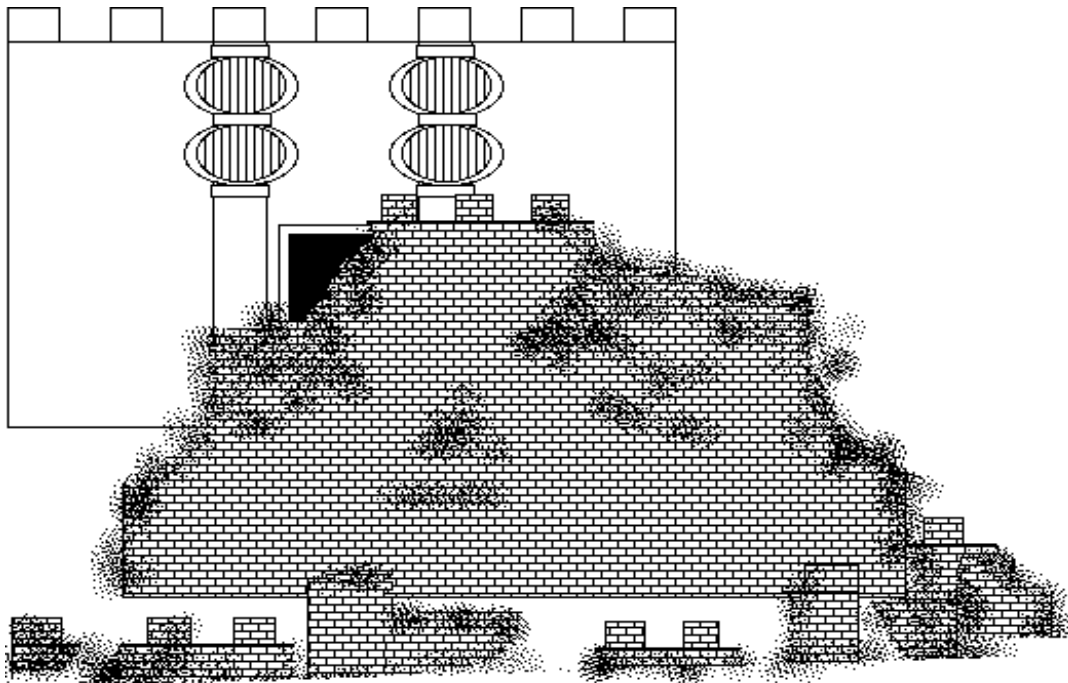

124. NEHEMIAH'S PRAYER & VIEWING THE WALL (NEHEMIAH 1:1-2:20)

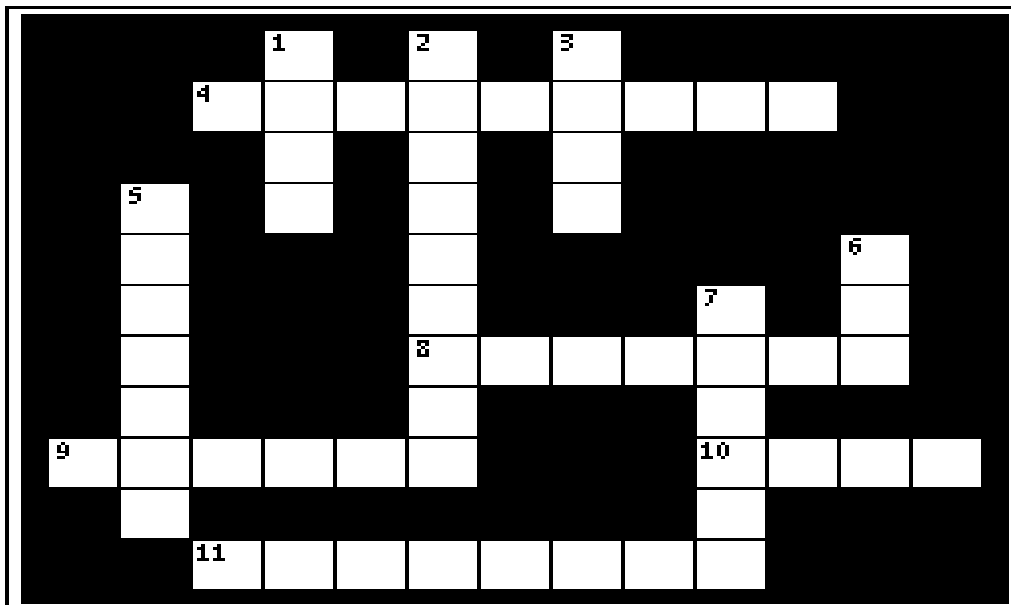

- 9 ACROSS "O Lord, I pray, please let Your ear be attentive to the _____ of Your servant, and to the prayer of Your servants who desire to fear Your name." **NEHEMIAH 1:11**
- 11 ACROSS Nehemiah asked about "the Jews who had escaped, who had _____ the captivity, and concerning Jerusalem." **NEHEMIAH 1:2**
- 3 DOWN And they said to him, "The _____ of Jerusalem is broken down, and its gates are burned with fire." **NEHEMIAH 1:3**
- 1 DOWN Nehemiah said, "So it was, when I heard these words, that I sat down and _____, and mourned for many days; I was fasting and praying before the God of heaven." **NEHEMIAH 1:4**
- 2 DOWN Nehemiah was the king's _____. **NEHEMIAH 1:11**
- 6 DOWN "The king said to me, 'Why is your face _____, since you are not sick? This is nothing but sorrow of heart.'" **NEHEMIAH 2:2**
- 8 ACROSS "I said to the king, 'If it pleases the king, and if your servant has found favor in your sight, I ask that you send me to Judah, to the city of my fathers' tombs, that I might _____ it.'" **NEHEMIAH 2:5**
- 5 DOWN "Furthermore I said to the king, 'If it pleases the king, let _____ be given to me for the governors of the region beyond the River.'" **NEHEMIAH 2:7**
- 4 ACROSS Nehemiah writes, "So I came to _____ and was there three days." **NEHEMIAH 2:11**
- 7 DOWN He writes, "I went out by night through the Valley Gate to the Serpent Well and the Refuse Gate, and _____ the walls of Jerusalem which were broken down and its gates which were burned with fire." **NEHEMIAH 2:14**
- 10 ACROSS "So they said, 'Let us rise up and build.' Then they set their hands to do this good _____." **NEHEMIAH 2:18**

Bible Story 125

**REBUILDING &
COMPLETION
OF THE WALL**

NEHEMIAH 4:1-7:3

125. THE REBUILDING & COMPLETION OF THE WALL

(NEHEMIAH 4:1-7:3)



"So the wall was finished in the twenty and fifth *day* of *the month* Elul, in fifty and two days."
NEHEMIAH 6:15

125. THE REBUILDING & COMPLETION OF THE WALL (NEHEMIAH 4:1-7:3)

MEMORY VERSE:

"Our God will fight for us." NEHEMIAH 4:20

TRUE OR FALSE:

1. "When Sanballat heard that we were rebuilding the wall, that he was furious and very indignant, and mocked the Jews." NEHEMIAH 4:1

TRUE OR FALSE

UNDERLINE THE CORRECT ANSWER:

2. "So we built the wall, and the entire wall was joined together up to half its height..." NEHEMIAH 4:6
- for the people had a mind to work
 - for the pay was great

CIRCLE THE CORRECT WORDS:

3. "Now it happened, when Sanballat, Tobiah, the Arabs, the Ammonites, and the Ashdodites heard that the walls of Jerusalem were being restored and the gaps were beginning to be closed, that they became very (HAPPY, ANGRY), and all of them conspired together to come and (ATTACK, BUILD) Jerusalem and create confusion." NEHEMIAH 4:7-8
4. "Nevertheless we made our (COMPLAINT, PRAYER) to our God, and because of them, we set a watch against them day and night." NEHEMIAH 4:9

TRUE OR FALSE:

5. Nehemiah writes, "half of my servants worked at construction, while the other half held the spears, the shields, the bows, and wore armor; and the leaders were behind all the house of Judah." NEHEMIAH 4:16

TRUE OR FALSE

CIRCLE THE CORRECT WORDS:

6. "Those who built on the wall, and those who carried burdens, loaded themselves so that with one hand they worked at (CONSTRUCTION, DESTRUCTION), and with the other held a (SPOON, WEAPON)." NEHEMIAH 4:17
7. "Then I said to the nobles, the rulers, and the rest of the people, 'The work is great and extensive, and we are separated far from one another on the wall. Therefore, wherever you hear the sound of the trumpet, rally to us there. Our God will fight (FOR, AGAINST) us.' " NEHEMIAH 4:19-20

FILL IN THE BLANK:

8. "So the wall was _____ on the twenty-fifth day of the month of Elul, in fifty-two days." NEHEMIAH 6:15

CIRCLE THE CORRECT WORDS:

9. "Then it was, when the wall was built and I had hung the doors, when the gatekeepers, the singers, and the Levites had been appointed, that I gave charge of (BETHLEHEM, JERUSALEM) to my brother Hanani, and Hananiah the leader of the citadel." NEHEMIAH 7:1-2

TRUE OR FALSE:

10. When the seventh month came, the children of Israel were not in their cities. NEHEMIAH 7:73

TRUE OR FALSE

125. THE REBUILDING & COMPLETION OF THE WALL (NEHEMIAH 4:1-7:3)

N E H E M I A H N W W O O Y J
 H W J V D J I B B K H Q H E E
 F G J D I H L V L Y J A R Q P
 Q D E H S I N I F Y T U C B G
 M M S I V N D Q L E S E O G T
 H W A M E F S O D A R G N O E
 R D N O M G U V L K V W S J P
 E I B O N I J E C H A A T M M
 Y C A F B E M A N L J T R N U
 A P L U A G T Y L L D N U R R
 R L L S S T N A V R E S C M T
 P O A R A W L X K B U B T I G
 M P T O S T L I U B V K I F L
 G D C O Z K J C A R C L O J Y
 Q Q N D W O T J U O G D N Q T

ATTACK

FINISHED

SANBALLAT

BUILT

JERUSALEM

SERVANTS

CONSTRUCTION

NEHEMIAH

TRUMPET

DOORS

PRAYER

WALL

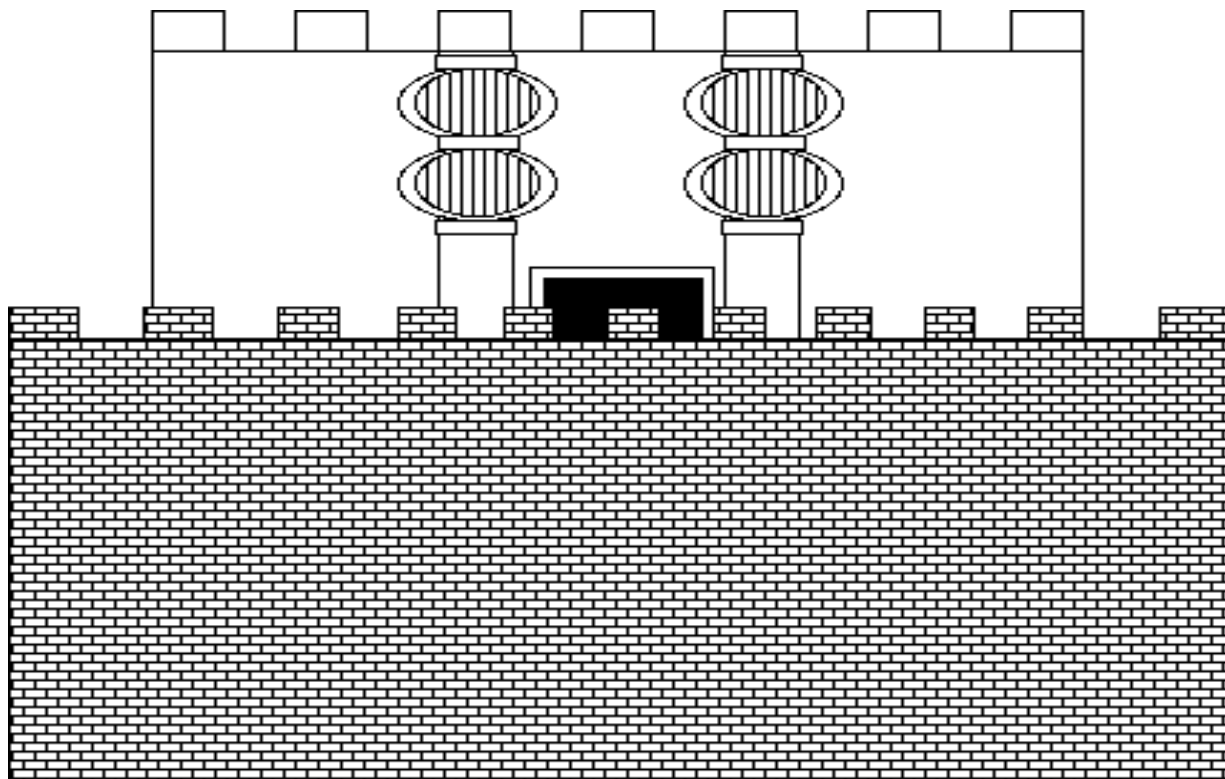

125. THE REBUILDING & COMPLETION OF THE WALL (NEHEMIAH 4:1-7:3)

MEMORY VERSE:

"Our God will fight for us." NEHEMIAH 4:20

TRUE OR FALSE:

1. "When Sanballat heard that we were rebuilding the wall, that he was furious and very indignant, and mocked the Jews." NEHEMIAH 4:1

TRUE OR FALSE

UNDERLINE THE CORRECT ANSWER:

2. "So we built the wall, and the entire wall was joined together up to half its height..." NEHEMIAH 4:6
a. for the people had a mind to work
b. for the pay was great

FILL IN THE BLANKS:

3. "Now it happened, when Sanballat, Tobiah, the Arabs, the Ammonites, and the Ashdodites heard that the walls of Jerusalem were being restored and the gaps were beginning to be closed, that they became very _____, and all of them conspired together to come and _____ Jerusalem and create confusion." NEHEMIAH 4:7-8
4. "Nevertheless we made our _____ to our God, and because of them, we set a watch against them day and night." NEHEMIAH 4:9

TRUE OR FALSE:

5. Nehemiah writes, "half of my servants worked at construction, while the other half held the spears, the shields, the bows, and wore armor; and the leaders were behind all the house of Judah." NEHEMIAH 4:16

TRUE OR FALSE

FILL IN THE BLANKS:

6. "Those who built on the wall, and those who carried burdens, loaded themselves so that with one hand they worked a _____, and with the other held a _____." NEHEMIAH 4:17
7. "Then I said to the nobles, the rulers, and the rest of the people, 'The work is great and extensive, and we are separated far from one another on the wall. Therefore, wherever you hear the sound of the _____, rally to us there. Our God will fight for us.' " NEHEMIAH 4:19-20
8. "So the wall was _____ on the twenty-fifth day of the month of Elul, in fifty-two days." NEHEMIAH 6:15
9. "Then it was, when the wall was built and I had hung the doors, when the gatekeepers, the singers, and the Levites had been appointed, that I gave charge of _____ to my brother Hanani, and Hananiah the leader of the citadel." NEHEMIAH 7:1-2

TRUE OR FALSE:

10. When the seventh month came, the children of Israel were not in their cities. NEHEMIAH 7:73

TRUE OR FALSE

125. THE REBUILDING & COMPLETION OF THE WALL (NEHEMIAH 4:1-7:3)

A C H H K R I H N L L C V O R L P Q X N
 L M G P O C Y B S E R V A N T S L T L T
 S S M P N J A M D D L O M X Q I O H M V
 V L U O G Z S T O I A Y G M C B E E E B
 P S Q R N F Y B T P G K D G I V P N J K
 Z N J B I I D N F A H E O A R V K P S C
 S P V N C J T U O S G O H Q H T S A L E
 M M Q G N T Y E E I N J T O N L N T D U
 D O O R S F E T S M T S C T N B N L Z Z
 B N D B E E I P M W W C W H A C U Z P B
 A Q D L B D B E M L B Z U L V M W T E E
 K Q D L O O L L M U W F L R G G S T B Q
 I H V D P A O Y Q G R A I K T P C X L A
 Y V H N S T J L R S T T V N R S T S I L
 T S V U U L C H K S B N N A I K N M A B
 A Z R X W I V M B Z V W Y W R S P O I F
 F E D Z A U G A D R B E V W K M H H C H
 J U K S L B R K F O R I M X Z P M E R V
 Z D M V L A W K H J H O U L L E S V D E
 B F S M U R H N E H E M I A H I D Y O L

AMMONITES
 ARABS
 ASHDODITES
 ATTACK
 BUILT
 CONSTRUCTION

DOORS
 FINISHED
 JERUSALEM
 NEHEMIAH
 PRAYER

SANBALLAT
 SERVANTS
 TOBIAH
 TRUMPET
 WALL

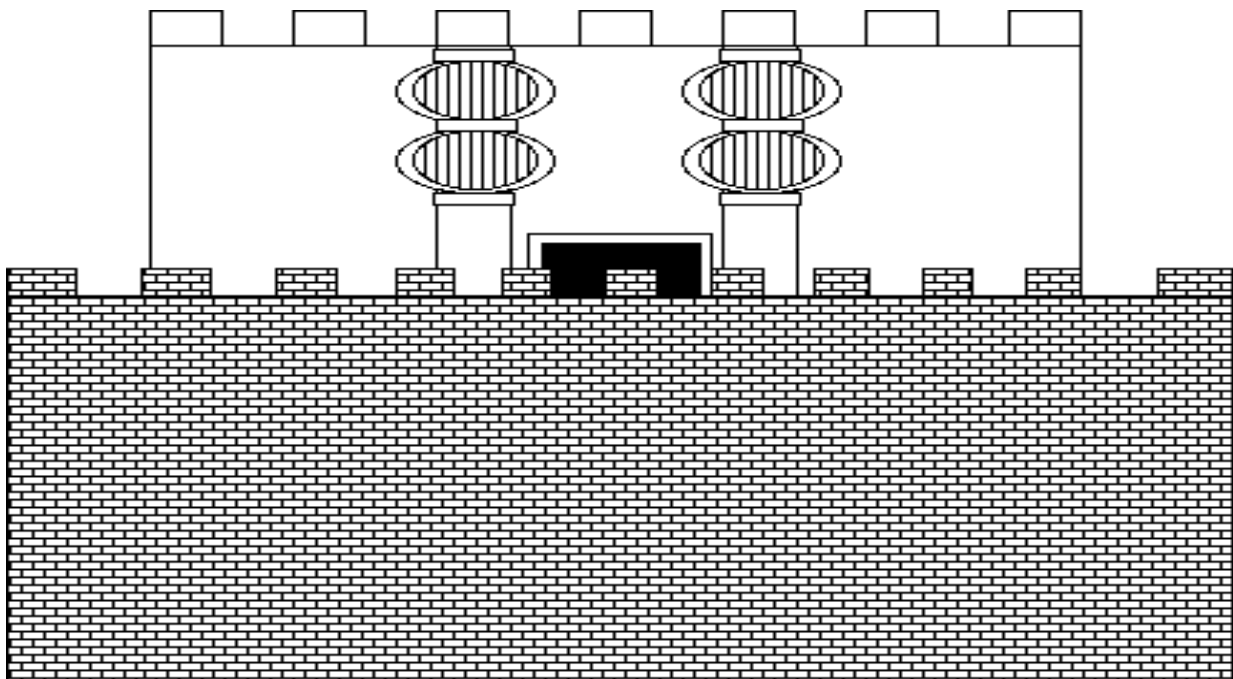

125. THE REBUILDING & COMPLETION OF THE WALL (NEHEMIAH 4:1-7:3)

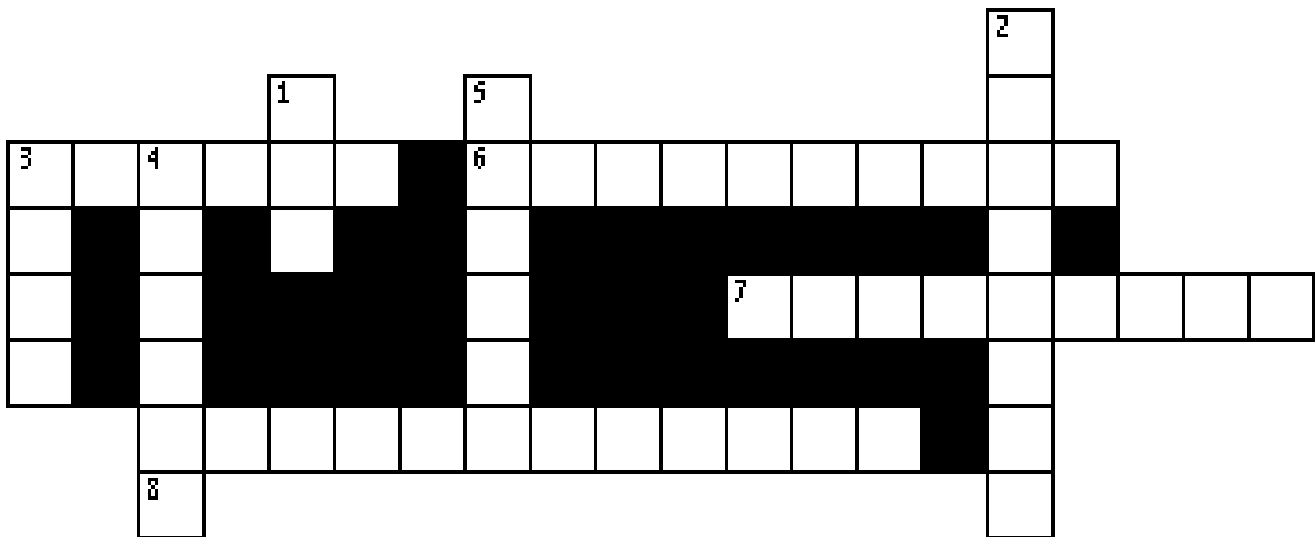

- 6 ACROSS "When Sanballat heard that we were _____ the wall, that he was furious and very indignant, and mocked the Jews." **NEHEMIAH 4:1**
- 3 DOWN "So we built the _____, and the entire wall was joined together up to half its height for the people had a mind to work." **NEHEMIAH 4:6**
- 4 DOWN "Now it happened, when Sanballat, Tobiah, the Arabs, the Ammonites, and the Ashdodites heard that the walls of Jerusalem were being restored and the gaps were beginning to be closed, that they became very angry, and all of them conspired together to come and _____ Jerusalem and create confusion." **NEHEMIAH 4:7-8**
- 5 DOWN "Nevertheless we made our _____ to our God, and because of them, we set a watch against them day and night." **NEHEMIAH 4:9**
- 8 ACROSS Nehemiah writes, "half of my servants worked at _____, while the other half held the spears, the shields, the bows, and wore armor; and the leaders were behind all the house of Judah." **NEHEMIAH 4:16**
- 3 ACROSS "Those who built on the wall, and those who carried burdens, loaded themselves so that with one hand they worked at construction, and with the other held a _____." **NEHEMIAH 4:17**
- 1 DOWN "Then I said to the nobles, the rulers, and the rest of the people, 'The work is great and extensive, and we are separated far from one another on the wall. Therefore, wherever you hear the sound of the trumpet, rally to us there. Our _____ will fight for us.'" **NEHEMIAH 4:19-20**
- 2 DOWN "So the wall was _____ on the twenty-fifth day of the month of Elul, in fifty-two days." **NEHEMIAH 6:15**
- 7 ACROSS "Then it was, when the wall was built and I had hung the doors, when the gatekeepers, the singers, and the Levites had been appointed, that I gave charge of _____ to my brother Hanani, and Hananiah the leader of the citadel." **NEHEMIAH 7:1-2**

Bible Story 126

EZRA READS THE LAW

NEHEMIAH 8:1-9:5

126. EZRA READS THE LAW

(NEHEMIAH 8:1-9:5)



"And Ezra opened the book in the sight of all the people; (for he was above all the people;) and when he opened it, all the people stood up: and Ezra blessed the LORD, the great God. And all the people answered, Amen, Amen, with lifting up their hands: and they bowed their heads, and worshipped the LORD with *their* faces to the ground."

NEHEMIAH 8:5-6

126. EZRA READS THE LAW

(NEHEMIAH 8:1-9:5)

MEMORY VERSE:

"Stand up and bless the LORD your God forever and ever! Blessed be Your glorious name, which is exalted above all blessing and praise!" NEHEMIAH 9:5

FILL IN THE BLANK:

1. "Now all the people gathered together as one man in the open square that was in front of the Water Gate; and they told _____ the scribe to bring the Book of the Law of Moses, which the LORD had commanded Israel." **NEHEMIAH 8:1**

TRUE OR FALSE:

2. "And Ezra opened the book in the sight of all the people, for he was standing above all the people; and when he opened it, all the people stood up." **NEHEMIAH 8:5**
TRUE OR FALSE

CIRCLE THE CORRECT WORDS:

3. "And Ezra (**BLESSED, FORGOT**) the LORD, the great God. Then all the people answered, 'Amen, Amen!' while lifting up their hands. And they bowed their heads and worshiped the LORD with their faces to the ground." **NEHEMIAH 8:6**
4. "They read distinctly from the book, in the Law of God; and they gave the sense, and helped them to (**READ, UNDERSTAND**) the reading." **NEHEMIAH 8:8**
5. "And Nehemiah, who was the governor, Ezra the priest and scribe, and the Levites who taught the people said to all the people, 'This day is holy to the LORD your God; do not mourn nor weep.' For all the people (**WEPT, SLEPT**), when they heard the words of the Law." **NEHEMIAH 8:9**
6. "Then he said to them, 'Go your way, eat the fat, drink the sweet, and send portions to those for whom nothing is prepared; for this day is holy to our LORD. Do not sorrow, for the joy of the (**LORD, WORLD**) is your strength.' " **NEHEMIAH 8:10**
7. "They found written in the Law, which the LORD had commanded by Moses, that the children of Israel should dwell in (**PALACES, BOOTHS**) during the feast of the seventh month." **NEHEMIAH 8:14**

TRUE OR FALSE:

8. But the people said, "We will not dwell in booths!" **NEHEMIAH 8:16**
TRUE OR FALSE
9. "The whole congregation of those who had returned from the captivity made booths and sat under the booths." **NEHEMIAH 8:17**
TRUE OR FALSE
10. "Also day by day, from the first day until the last day, he read from the Book of the Law of God." **NEHEMIAH 8:18**
TRUE OR FALSE

CIRCLE THE CORRECT WORD:

11. "Now on the twenty-fourth day of this month the children of Israel were assembled with fasting, in sackcloth, and with dust on their heads. Then those of the Israelite lineage separated themselves from all foreigners; and they stood and (**HID, CONFESSED**) their sins and the iniquities of their fathers." **NEHEMIAH 9:1-2**

126. EZRA READS THE LAW

(NEHEMIAH 8:1-9:5)

W O R S H I P E D L O R D N O
 K R C A T G P L N S G T K P V
 Y O G P Y O E E Y T F Z E P B
 Y D E S S E F N O C I N B F N
 E W S E Q B P Y W P S V O H G
 H W A G E J O T C Q L K O J N
 D H C A T M G O U O Y E K K I
 E J K T A N G A T Y M B O Z T
 S S C N G R R P N H R M F W S
 S R L B R E S V R E S S T W A
 E V O K E M C E G Z A H H V F
 L J T L T I R N I R U J E H G
 B D H D A F I J K A V L L W P
 L U O O W J B A F T W M A S E
 B V Q H K Q E H T T A B W R I

BLESSED
 BOOK OF THE LAW
 BOOTHS
 CONFESSED
 EZRA

FASTING
 LORD
 OPEN SQUARE
 PEOPLE
 SACKCLOTH

SCRIBE
 WATER GATE
 WEPT
 WORSHIPED

ENTER

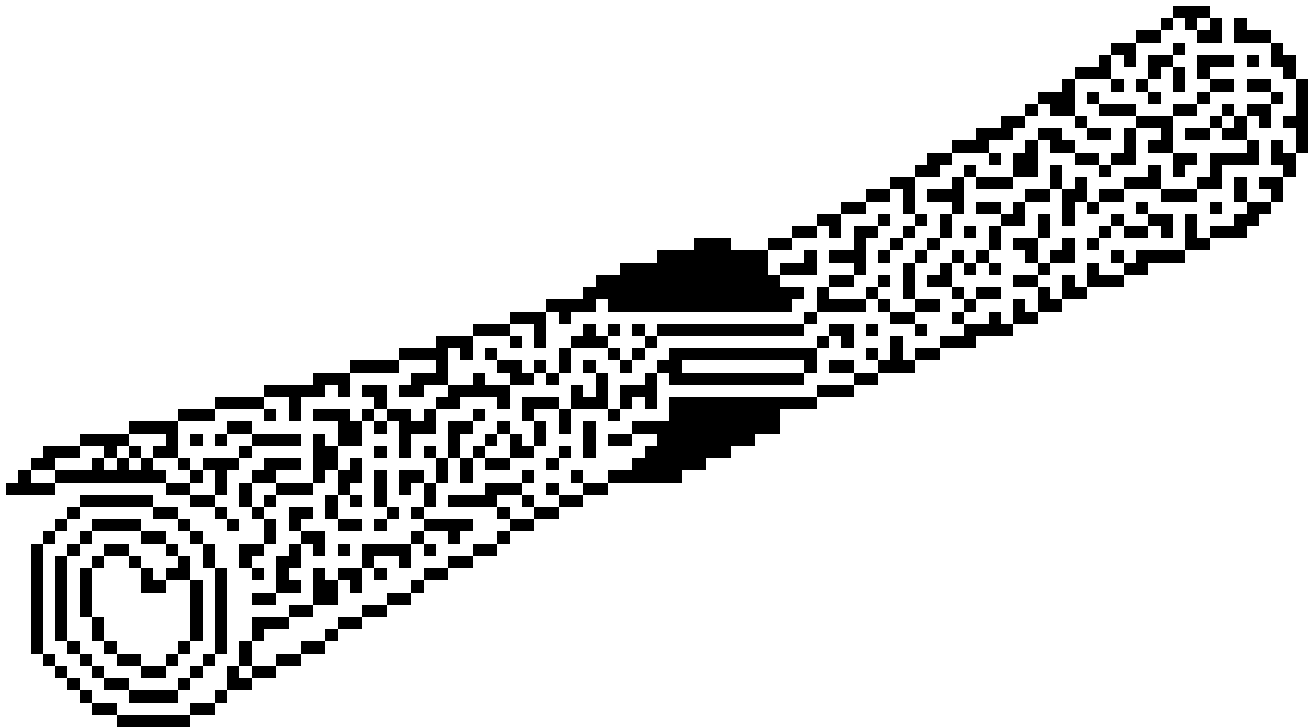

126. EZRA READS THE LAW

(NEHEMIAH 8:1-9:5)

MEMORY VERSE:

"Stand up and bless the LORD your God forever and ever! Blessed be Your glorious name, which is exalted above all blessing and praise!" NEHEMIAH 9:5

FILL IN THE BLANK:

1. "Now all the people gathered together as one man in the open square that was in front of the Water Gate; and they told _____ the scribe to bring the Book of the Law of Moses, which the LORD had commanded Israel."
NEHEMIAH 8:1

TRUE OR FALSE:

2. "And Ezra opened the book in the sight of all the people, for he was standing above all the people; and when he opened it, all the people stood up." **NEHEMIAH 8:5**
TRUE OR FALSE

FILL IN THE BLANKS:

3. "And Ezra _____ the LORD, the great God. Then all the people answered, 'Amen, Amen!' while lifting up their hands. And they bowed their heads and worshiped the LORD with their faces to the ground." **NEHEMIAH 8:6**
4. "They read distinctly from the book, in the Law of God; and they gave the sense, and helped them to _____ the reading." **NEHEMIAH 8:8**
5. "And Nehemiah, who was the governor, Ezra the priest and scribe, and the Levites who taught the people said to all the people, 'This day is holy to the LORD your God; do not mourn nor weep.' For all the people _____, when they heard the words of the Law." **NEHEMIAH 8:9**
6. "Then he said to them, 'Go your way, eat the fat, drink the sweet, and send portions to those for whom nothing is prepared; for this day is holy to our LORD. Do not sorrow, for the joy of the _____ is your strength.'" **NEHEMIAH 8:10**
7. "They found written in the Law, which the LORD had commanded by Moses, that the children of Israel should dwell in _____ during the feast of the seventh month." **NEHEMIAH 8:14**

TRUE OR FALSE:

8. But the people said, "We will not dwell in booths!" **NEHEMIAH 8:16**
TRUE OR FALSE
9. "The whole congregation of those who had returned from the captivity made booths and sat under the booths."
NEHEMIAH 8:17
TRUE OR FALSE
10. "Also day by day, from the first day until the last day, he read from the Book of the Law of God."
NEHEMIAH 8:18
TRUE OR FALSE

FILL IN THE BLANK:

11. "Now on the twenty-fourth day of this month the children of Israel were assembled with fasting, in sackcloth, and with dust on their heads. Then those of the Israelite lineage separated themselves from all foreigners; and they stood and _____ their sins and the iniquities of their fathers." **NEHEMIAH 9:1-2**

126. EZRA READS THE LAW

(NEHEMIAH 8:1-9:5)

G V C I N A O U J Q K P T H M Z O N D B
 D D A C D L N U T U B Y O K Q O I I Y H
 P D L T R B H T A O P E N S Q U A R E J
 K Z D C B Z H T A Q C F M K N A R S S Y
 S Z O E A O I T O T D O J G N I T S A F
 P O Z J P Z O D U L W J K R Y B F V M N
 P W M W Z I U K E H C W G E M N Y M N P
 R H F Y E N H D O T K K H N A N B N B G
 X Q M J B K A S D F I S C C S L D A S N
 O I Q T S O F Q R E T S D A V D F D E G
 S W S N M C O C N O S H G E S L B D J P
 L L A A D O R T Q T W S E V S U E W M S
 K H Q T W B F I H R E I E L Y S N T G O
 W T V S E H T M B S P A D F A F E L O T
 V Y P L T R Q J N E I G V C N W T L V W
 J O B P Q F G K N R Y W B C K O L A B I
 X A E P X A H A A W B A G D W L C O S H
 W W Q U I V R S T P B F R H L Y U A P J
 E P E O P L E Z Y E P O C R W H W P T D
 L V J T T I A M E N L U Z E W X Q A W U

BLESSED
 BOOK OF THE LAW
 BOOTHS
 CONFESSED
 EZRA

FASTING
 LORD
 OPEN SQUARE
 PEOPLE
 SACKCLOTH

SCRIBE
 WATER GATE
 WEPT
 WORSHIPED

ENTER

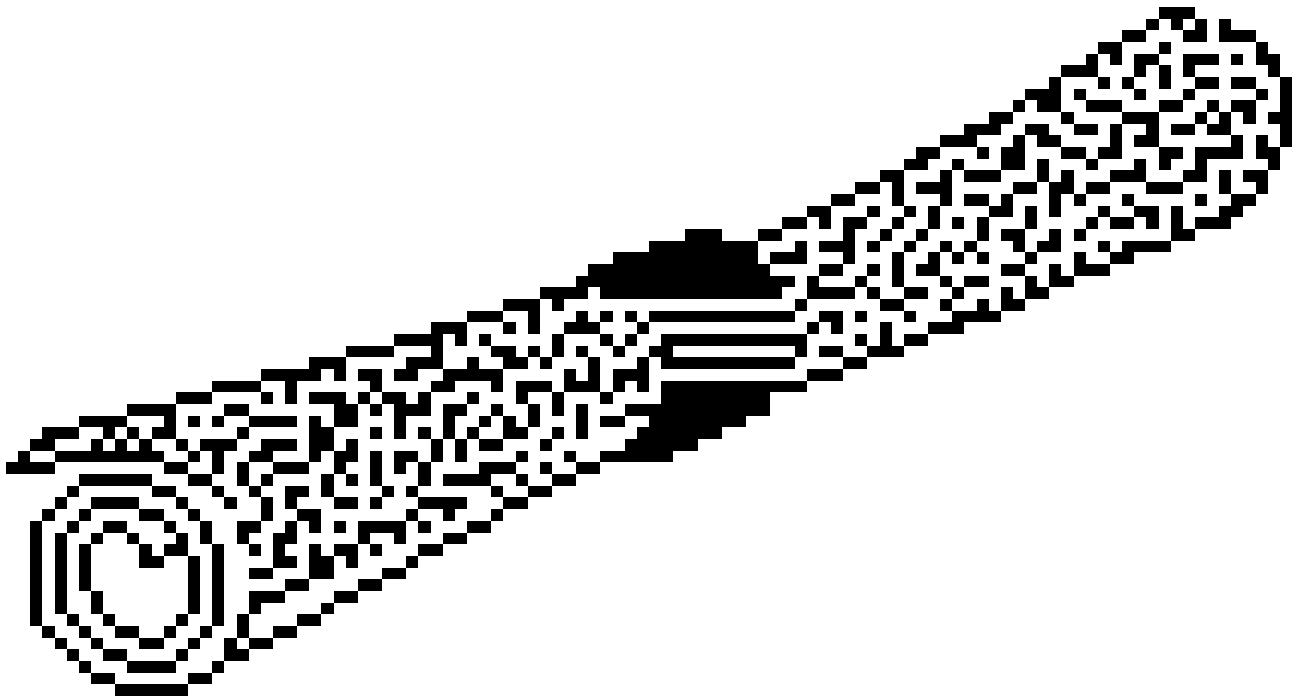

126. EZRA READS THE LAW

(NEHEMIAH 8:1-9:5)

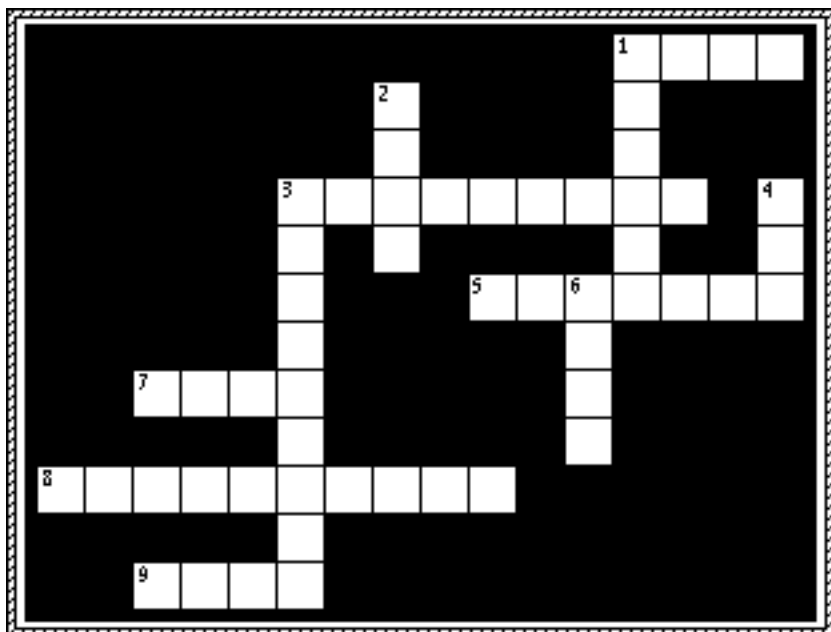

- 6 DOWN "They told _____ the scribe to bring the Book of the Law of Moses, which the LORD had commanded Israel." **NEHEMIAH 8:1**
- 1 ACROSS "And Ezra opened the _____ in the sight of all the people, for he was standing above all the people; and when he opened it, all the people stood up." **NEHEMIAH 8:5**
- 5 ACROSS "And Ezra _____ the LORD, the great God." **NEHEMIAH 8:6**
- 8 ACROSS "They read distinctly from the book, in the Law of God; and they gave the sense, and _____ helped them to _____ the reading." **NEHEMIAH 8:8**
- 2 DOWN "This day is holy to the LORD your God; do not mourn nor weep.' For all the people _____, when they heard the words of the Law." **NEHEMIAH 8:9**
- 9 ACROSS "Do not sorrow, for the joy of the _____ is your strength." **NEHEMIAH 8:10**
- 1 DOWN "They found written in the Law, which the LORD had commanded by Moses, that the children of Israel should dwell in _____ during the feast of the seventh month." **NEHEMIAH 8:14**
- 3 ACROSS "The whole congregation of those who had returned from the _____ made booths and _____ sat under the booths." **NEHEMIAH 8:17**
- 4 DOWN "Also day by day, from the first day until the last day, he read from the Book of the Law of _____." **NEHEMIAH 8:18**
- 3 DOWN "Then those of the Israelite lineage separated themselves from all foreigners; and they _____ stood and _____ their sins and the iniquities of their fathers." **NEHEMIAH 9:2**
- 7 ACROSS "Stand up and bless the LORD your God forever and ever! Blessed be Your glorious _____, which is exalted above all blessing and praise!" **NEHEMIAH 9:5**

Bible Story 127

**ESTHER
BECOMES QUEEN**

ESTHER 2:1-18

127. ESTHER BECOMES QUEEN

(ESTHER 2:1-18)



"The king loved Esther more than all the other women,
and she obtained grace and favor in his sight..."

ESTHER 2:17

127. ESTHER BECOMES QUEEN

(ESTHER 2:1-18)

MEMORY VERSE:

"Charm is deceitful and beauty is vain, but a woman who fears the LORD, she shall be praised." Proverbs 31:30

TRUE OR FALSE:

1. King Ahasuerus's "servants who attended him said, 'Let beautiful young virgins be sought for the king.'" **ESTHER 2:2**

TRUE OR FALSE

CIRCLE THE CORRECT WORDS:

2. "Then let the young woman who pleases the king be (**KING, QUEEN**) instead of Vashti." **ESTHER 2:4**
3. "Mordecai had brought up Hadassah, that is, (**ESTHER, EPHRUM**), his uncle's daughter, for she had neither father nor mother. The young woman (**WAS, WAS NOT**) lovely and beautiful." **ESTHER 2:7**

FILL IN THE BLANKS:

4. "Now when the turn came for Esther the daughter of Abihail the uncle of Mordecai, who had taken her as his daughter, to go into the king, she requested _____ but what Hegai the king's eunuch, the custodian of the women, advised." **ESTHER 2:15**
5. "And she obtained favor in the sight of _____ who saw her." **ESTHER 2:15**

TRUE OR FALSE:

6. "The king loved Esther more than all the other women, and she obtained grace and favor in his sight more than all the virgins; so he set the royal crown upon her head and made her queen instead of Vashti." **ESTHER 2:17**

TRUE OR FALSE

7. "Then the king made a great feast, the Feast of Esther, for all his officials and servants; and he proclaimed a holiday in the provinces and gave gifts according to the generosity of a king." **ESTHER 2:18**

TRUE OR FALSE

127. ESTHER BECOMES QUEEN

(ESTHER 2:1-18)

T K T F C O L G M C Q D D P Z
Q Y H R A K L G B S Q F D P S
X T D A B V M T A L H H D R V
O P T A Y I O E K R E H T S E
N S N J A J A R I S V G V G M
C J Y Y D Q S C Y D Z U N B O
X V B G I X O L E T E I V N N
B D P H L C I S S D K V D G G
I T R S O T R A P N R N O B I
F T U E H Z E O T A E O K L C
A Q L S B F A V W E L Q M L N
W F A Q Y P L P U N C A X L E
X V N M U Q K Q F P N J C N B
B N Z B W L N Z Z M U V S E P
Y F H X L A M S B N U Q H N U

CROWN
ESTHER
FAVOR
FEAST

HOLIDAY
KING
LOVED
MORDECAI

PALACE
QUEEN
UNCLE
VASHTI



127. ESTHER BECOMES QUEEN

(ESTHER 2:1-18)

MEMORY VERSE:

"Charm is deceitful and beauty is vain, but a woman who fears the LORD, she shall be praised." Proverbs 31:30

TRUE OR FALSE:

1. King Ahasuerus's "servants who attended him said, 'Let beautiful young virgins be sought for the king.'" **ESTHER 2:2**

TRUE OR FALSE

2. "Then let the young woman who pleases the king be queen instead of Vashti." **ESTHER 2:4**

TRUE OR FALSE

FILL IN THE BLANKS:

3. "Mordecai had brought up Hadassah, that is, _____, his uncle's daughter, for she had neither father nor mother. The young woman was _____ and _____." **ESTHER 2:7**

4. "So it was, when the king's command and decree were heard, and when many of the young women were gathered at Shushan the citadel, under the custody of Hegai, that Esther also was taken to the king's _____, into the care of Hegai the custodian of the women." **ESTHER 2:8**

5. "Now when the turn came for Esther the daughter of Abihail the uncle of Mordecai, who had taken her as his daughter, to go into the king, she requested _____ but what Hegai the king's eunuch, the custodian of the women, advised." **ESTHER 2:15**

6. "And she obtained favor in the sight of _____ who saw her." **ESTHER 2:15**

TRUE OR FALSE:

7. "The king loved Esther more than all the other women, and she obtained grace and favor in his sight more than all the virgins; so he set the royal crown upon her head and made her queen instead of Vashti." **ESTHER 2:17**

TRUE OR FALSE

FILL IN THE BLANKS:

8. "Then the king made a great feast, the _____ _____ _____, for all his officials and servants; and he proclaimed a holiday in the provinces and gave gifts according to the generosity of a king." **ESTHER 2:18**

127. ESTHER BECOMES QUEEN

(ESTHER 2:1-18)

U B A U S R H F M K N A H D K O T D U L Y A E M F
D C M H I E N H G Q R Z G R B I P S O W L O V E D
W P F E L U W P F J P S E C U P L J E K D T M Z R
R O H R S W O J H B I H U G K I A H P I J W X J K
K G K J J J R T A B Q M W R C T T L T J I L N S K
H U N S F N C B W R D M D G U E J H A F A V O R Y
D P C T F S Z I X B J S W N M J C Q S C P A O M R
P M U Y A D I L O H Q V Y G D K V O C A E P B X G
T N Q A O Z I A P K R O P Z L K T E S S V P U P I
B R D Z P K V M E E I J Z J S P W W C U T A L C K
H X C S E B V X S F L J W P V Z H E H E V X P D U
R D N D O Z B T G J S E K N R Y P B U A R V M T A
U C W J O F Q Y D T T A B I C Y J K E V F Q C X V
I U T Q C H Y L E E F W M U N O H S C D E D C X X
W G R E H T S E F O T S A E F G Q U N R J V V G O
V D I I F N E I P J A L W O M J A H Q E O S Z E U
B T W K K G L O U Z Y Z U F L F O H L H U M M I V
M A P T B X N N Z Z Y X F L B A A P A T G C F M Z
C S P D Y G C V C K O P I L X H W E K S F Z N R A
B T W Y N L V Q C C F J X M A A V V D E U L S P U
M O R D E C A I Q T V Q G S C H M A D Q N E M P E
H O Q H M R Q Z I I X U Y Z W Z F R O E D U R U F
P T T U H Q T U W O S E P F J Y S L K N B T O U P
D W A Q L I A A Z T V E Y P U N W W Q R K M A Z S
E F U S D P Q N K A M N B G N J U J K Y K O T V T

CROWN
ESTHER
FAVOR
FEAST OF ESTHER

HOLIDAY
KING AHASUERUS
LOVED
MORDECAI

PALACE
QUEEN
UNCLE
VASHTI

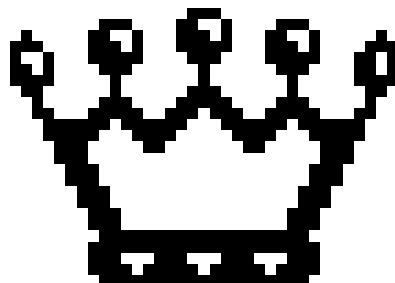

127. ESTHER BECOMES QUEEN

(ESTHER 2:1-18)

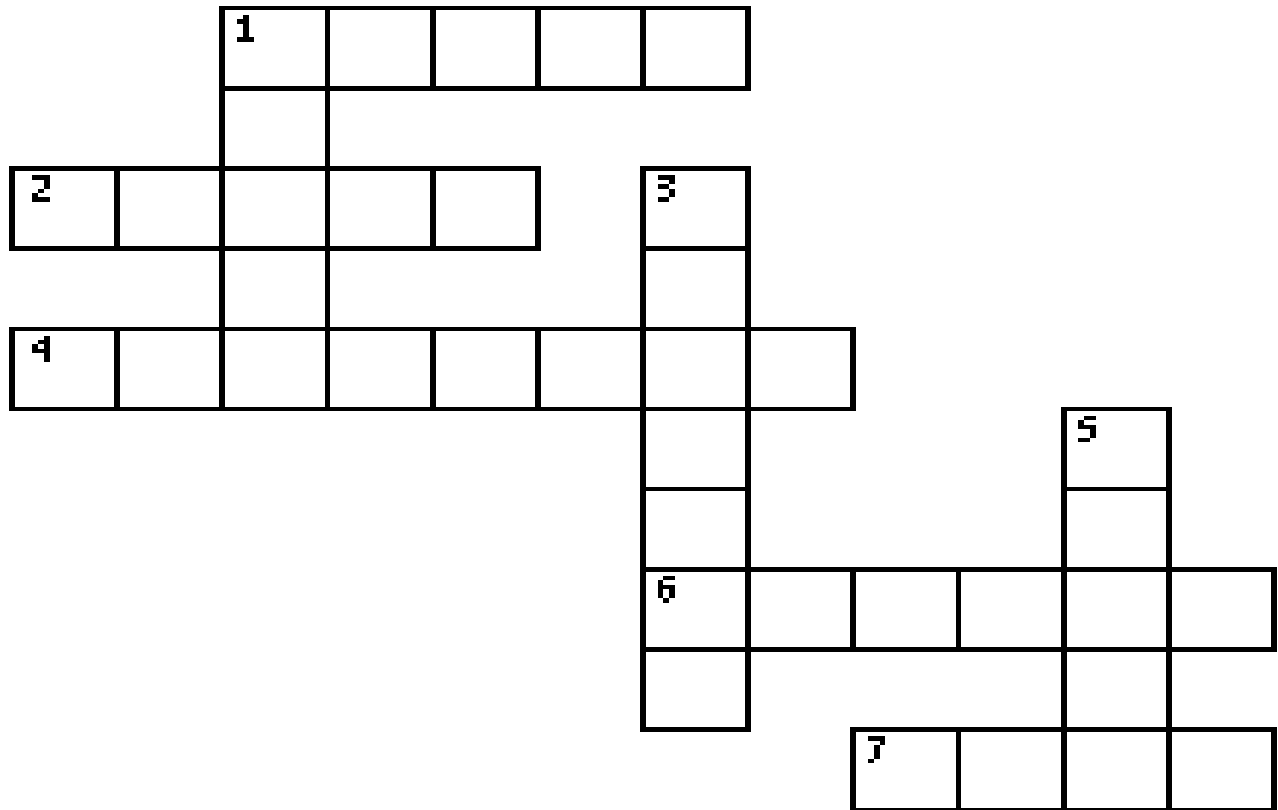

- 3 DOWN "Charm is deceitful and beauty is vain, but a woman who fears the LORD, she shall be _____" **PROVERBS 31:30**
- 7 ACROSS King Ahasuerus's "servants who attended him said, 'Let beautiful young virgins be sought for the _____'" **ESTHER 2:2**
- 5 DOWN "Then let the young woman who pleases the king be ____ instead of Vashti." **ESTHER 2:4**
- 4 ACROSS "_____ had brought up Hadassah, that is, Esther, his uncle's daughter, for she had neither father nor mother. The young woman was lovely and beautiful." **ESTHER 2:7**
- 6 ACROSS "Now when the turn came for _____ the daughter of Abihail the uncle of Mordecai, who had taken her as his daughter, to go into the king, she requested nothing but what Hegai the king's eunuch, the custodian of the women, advised." **ESTHER 2:15**
- 1 DOWN "And she obtained _____ in the sight of all who saw her." **ESTHER 2:15**
- 2 ACROSS "The king _____ Esther more than all the other women, and she obtained grace and favor in his sight more than all the virgins; so he set the royal crown upon her head and made her queen instead of Vashti." **ESTHER 2:17**
- 1 ACROSS "Then the king made a great _____, the Feast of Esther, for all his officials and servants; and he proclaimed a holiday in the provinces and gave gifts according to the generosity of a king." **ESTHER 2:18**

127. ESTHER BECOMES QUEEN

(ESTHER 2:1-18)

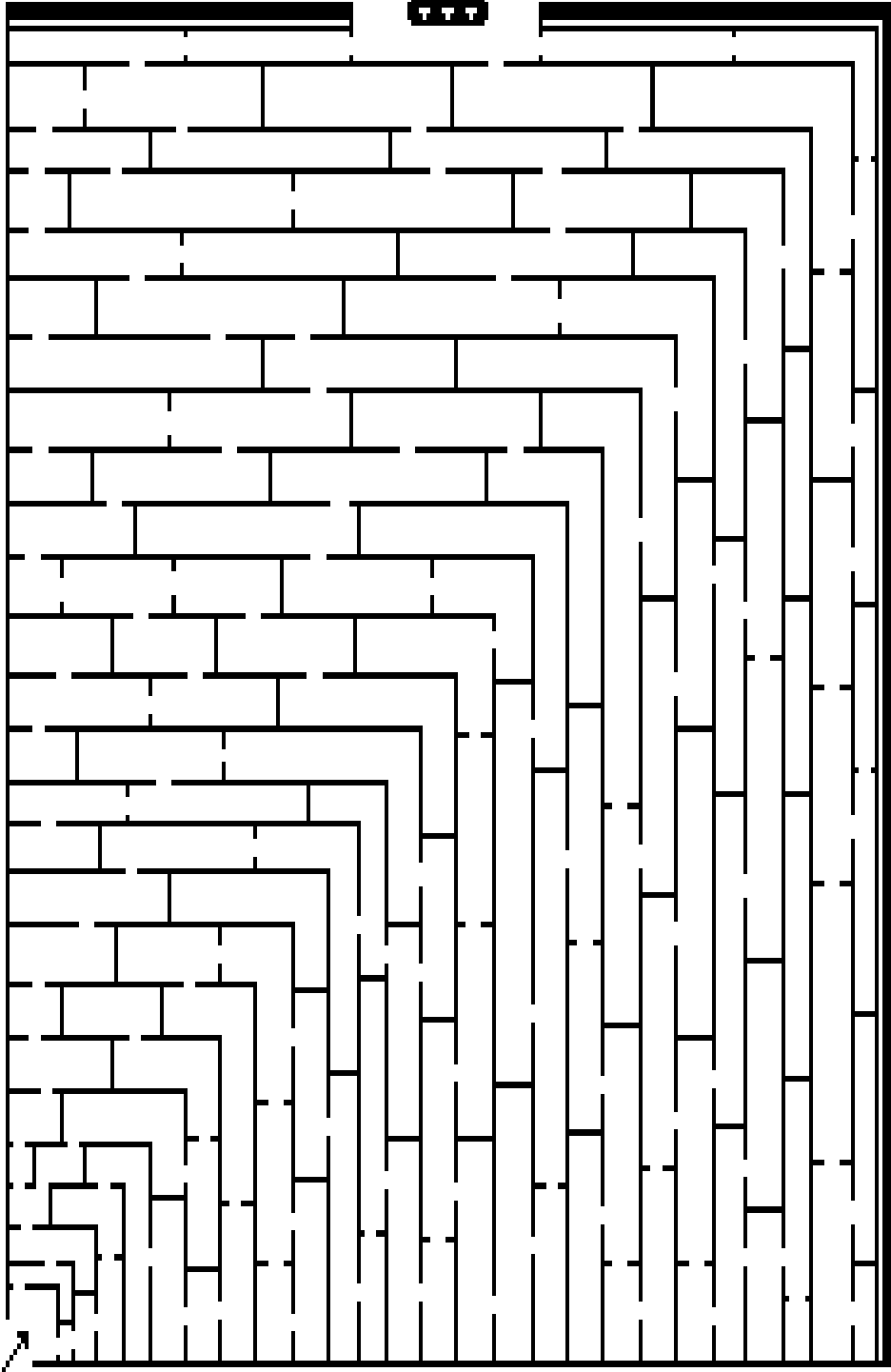

Bring Esther to the king

Bible Story 128

**MORDECAI
AND HAMAN**

ESTHER 2:19-3:15

128. MORDECAI AND HAMAN

(ESTHER 2:19-3:15)



"...when Haman saw that Mordecai bowed not, nor did him reverence,
then was Haman full of wrath."

ESTHER 3:4-5

128. MORDECAI AND HAMAN

(ESTHER 2:19-3:15)

MEMORY VERSE:

"For it is written, 'You shall worship the LORD your God, and Him only you shall serve.'" MATTHEW 4:10

TRUE OR FALSE:

1. "Now Esther had not yet revealed her kindred and her people, just as Mordecai had charged her, for Esther obeyed the command of Mordecai." **ESTHER 2:20**
TRUE OR FALSE

FILL IN THE BLANKS:

2. "In those days, while Mordecai sat within the king's _____, two of the king's eunuchs, Bigthan and Teresh, _____ became furious and sought to lay hands on King Ahasuerus." **ESTHER 2:21**

TRUE OR FALSE: WRITE T FOR TRUE OR F FOR FALSE

- | | | |
|----|---|--------|
| 3. | "So the matter became known to Mordecai who..." | T or F |
| | 2:22 told no one | _____ |
| | 2:22 told Queen Esther | _____ |
| | 2:22 Esther informed the king in Mordecai's name | _____ |
| | 2:23 when an inquiry was made into the matter, it was confirmed | _____ |
| | 2:23 both were let go | _____ |
| | 2:23 both were hanged on the gallows | _____ |

4. "After these things King Ahasuerus promoted Haman, the son of Hammedatha the Agagite, and advanced him and set his seat above all the princes who were with him." **ESTHER 3:1**
TRUE OR FALSE

CIRCLE THE CORRECT WORDS:

5. "When Haman saw that Mordecai did not bow or pay him homage, Haman was filled with (JOY, WRATH)." **ESTHER 3:5**
6. "But he disdained to lay hands on Mordecai alone, for they had told him of the people of Mordecai. Instead, Haman sought to (DESTROY, BLESS) all the Jews who were throughout the whole kingdom of Ahasuerus - the people of Mordecai." **ESTHER 3:6**
7. "(SOLDIERS, LETTERS) were sent by couriers into all the king's provinces, to destroy, to kill, and to annihilate all the Jews, both young and old, little children and women, in one day." **ESTHER 3:13**

128. MORDECAI AND HAMAN (ESTHER 2:19-3:15)

V Q J N T P K B J F G J E W S
 I H K Q Y N M O R D E C A I K
 O M S Q H O I P W U H C N E W
 N A O X U K R T E R E S H M L
 B U M D T E E T S T G Z C Q W
 O U J N G B E P S G N I K N W
 W T D D T N N N S E D H V Y Z
 H T T E E C I A E D D K C M O
 I C A A G C P K H S E K C A A
 U D O Y R N R Y I T T Y H S K
 A D A M R D A E A H G H E V U
 F Q U Q M E I H E O A I E B N
 F C E U T A Y F G M V M B R O
 H O M A G E N O W J B R A Y U
 T U G Q W W B D A K G E R N D

BIGHAN
 BOW
 COMMAND
 DECREE

DESTROY
 GATE
 HAMAN
 HANGED

HOMAGE
 JEWS
 KING
 KINGDOM

MORDECAI
 OBEYED
 QUEEN ESTHER
 TERESH

FIND YOUR WAY THROUGH THE DECREE

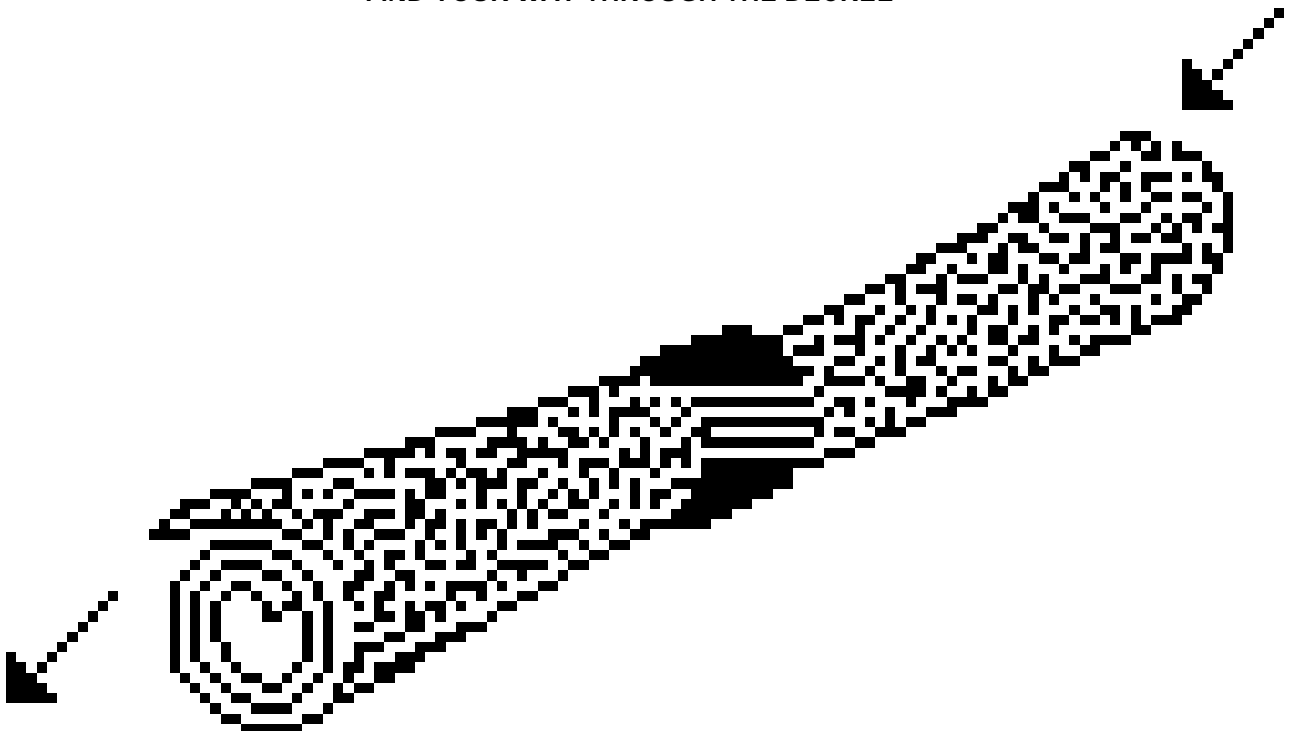

128. MORDECAI AND HAMAN

(ESTHER 2:19-3:15)

MEMORY VERSE:

"For it is written, 'You shall worship the LORD your God, and Him only you shall serve.'" MATTHEW 4:10

FILL IN THE BLANKS:

1. "Now Esther had not yet revealed her kindred and her people, just as Mordecai had charged her, for Esther _____ the command of Mordecai." **ESTHER 2:20**
2. "In those days, while Mordecai sat within the king's _____, two of the king's eunuchs, Bigthan and Teresh, _____ became furious and sought to lay hands on King Ahasuerus." **ESTHER 2:21**

TRUE OR FALSE: WRITE T FOR TRUE OR F FOR FALSE

3. "So the matter became known to Mordecai who..." **T or F**
2:22 told no one _____
2:22 told Queen Esther _____
2:22 Esther informed the king in Mordecai's name _____
2:23 when an inquiry was made into the matter, it was confirmed _____
2:23 both were let go _____
2:23 both were hanged on the gallows _____

FILL IN THE BLANKS:

4. "After these things King Ahasuerus _____ Haman, the son of Hammedatha the Agagite, and _____ him and set his seat _____ all the princes who were with him." **ESTHER 3:1**
5. "When Haman saw that Mordecai did not bow or pay him homage, Haman was filled with _____." **ESTHER 3:5**
6. "But he disdained to lay hands on Mordecai alone, for they had told him of the people of Mordecai. Instead, Haman sought to _____ all the Jews who were throughout the whole kingdom of Ahasuerus - the _____ people of Mordecai." **ESTHER 3:6**
7. "_____ were sent by couriers into all the king's provinces, to destroy, to kill, and to annihilate all the Jews, both young and old, little children and women, in one day."
ESTHER 3:13

128. MORDECAI AND HAMAN

(ESTHER 2:19-3:15)

O S Y C Z F T N N F H E N H A B O Y T C I E E F E
 J L O T E V T Q N O G M U T P H U T J V S E M W Y
 Q K A C M I D X N J D Q D L A J I W Y U G J J L U
 S W V J D K D N H A V M O R D E C A I B J A Q J W
 P V E W W O I O B W H N L U D Y I U R N P V V B I
 M J C E Q N M N C S B T U W Y K B H S E R E T B A
 B X A Y R A Q A G S G Y G Q S P R G Y O R T S E D
 B W L J G C C Y D A C M F I M G W H D H Z K E K C
 O E O E B H E Q W I H A L N B K G X C N F U V J L
 H L Z T I I U D K A Z A Y I U G T V G R B O V K P
 S B O W O B E Y E D M S S S N P K S S E N Z L U A
 S V M N T H J U I G H O H U S S W U Q H K M A M I
 R D F A A U A Q E W K V D V E O I T U T M A I X E
 V D C S L A K M P A K Y X G E R U H M S Z M L Y Y
 N Z M O B F S D A F R K O U N T U U J E N Z R R A
 G Z Q L M F M T O N E W I U J I M S Q N I B U T Q
 D O S P Z M J H I O N L R A M W K Q L E Z T U T A
 P W Q U Z T A T Y U R W F D G I F T J E F P C C O
 K H V T N Q E N B T C K Y D O H O P T U Z Z Q M Y
 S Q P N K T T T D O V W E W V J E L W Q X F N P E
 P I B D A H A S B M C Z J E S D P J K A D V R M A
 P L Q G O A A R W J C O D T P P K B M U K F U L E
 R H J R B U U R P E H A F L P E J J L V N H K C Q
 X H A N G E D W P K J K B A T O R H U A U N B S U
 O T I A H U E P Y G R U E O W L F S G E Y E I G T

BIGTHAN
 BOW
 COMMAND
 DECREE
 DESTROY

DOORKEEPERS
 GATE
 HAMAN
 HANGED

HOMAGE
 JEWS
 KING AHASUERUS
 KINGDOM

MORDECAI
 OBEYED
 QUEEN ESTHER
 TERESH

FIND YOUR WAY THROUGH THE DECREE

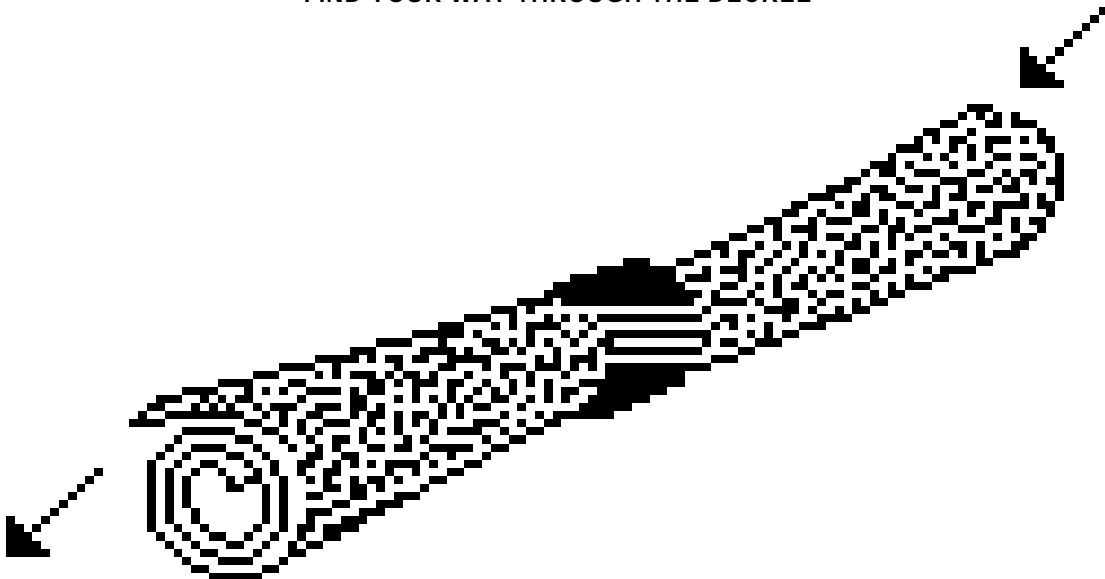

128. MORDECAI AND HAMAN

(ESTHER 2:19-3:15)

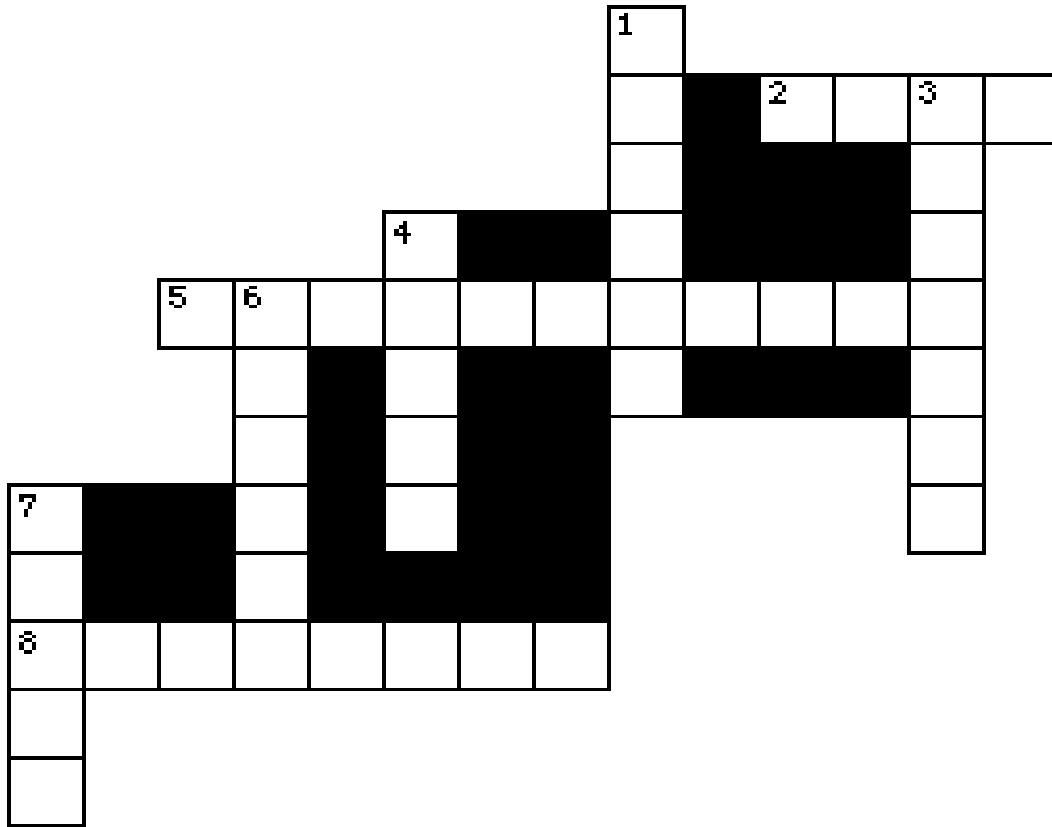

- 3 DOWN "For it is written, 'You shall _____ the LORD your God, and Him only you shall serve.'" **MATTHEW 4:10**
- 6 DOWN "Now Esther had not yet revealed her kindred and her people, just as Mordecai had charged her, for Esther _____ the command of Mordecai." **ESTHER 2:20**
- 5 ACROSS "In those days, while Mordecai sat within the king's gate, two of the king's eunuchs, Bigthan and Teresh, _____ became furious and sought to lay hands on King Ahasuerus." **ESTHER 2:21**
- 1 DOWN "So the matter became known to Mordecai who told Queen _____" **ESTHER 2:22**
- 7 DOWN "After these things King Ahasuerus promoted _____, the son of Hammedatha the Agagite, and advanced him and set his seat above all the princes who were with him." **ESTHER 3:1**
- 4 DOWN "When Haman saw that Mordecai did not bow or pay him homage, Haman was filled with _____." **ESTHER 3:5**
- 8 ACROSS "But he disdained to lay hands on _____ alone, for they had told him of the people of Mordecai. Instead, Haman sought to destroy all the Jews who were throughout the whole kingdom of Ahasuerus - the people of Mordecai." **ESTHER 3:6**
- 2 ACROSS "Letters were sent by couriers into all the king's provinces, to destroy, to kill, and to annihilate all the _____, both young and old, little children and women, in one day." **ESTHER 3:13**

Bible Story 129

**ESTHER PLEADS
FOR HER PEOPLE**

ESTHER 4:1-17

129. ESTHER PLEADS FOR HER PEOPLE (ESTHER 4:1-17)



"When Mordecai perceived all that was done, Mordecai rent his clothes, and put on sackcloth with ashes, and went out into the midst of the city, and cried with a loud and a bitter cry;" **ESTHER 4:1**

"So Esther's maids and her chamberlains came and told *it* her. Then was the queen exceedingly grieved; and she sent raiment to clothe Mordecai, and to take away his sackcloth from him: but he received *it* not."

ESTHER 4:4

129. ESTHER PLEADS FOR HER PEOPLE (ESTHER 4:1-17)

MEMORY VERSE:

"And so I will go to the king, which is against the law, and if I perish, I perish." ESTHER 4:16

UNDERLINE THE CORRECT ANSWER:

1. "When Mordecai learned all that had happened, he..." ESTHER 4:1
- tore his clothes
 - put on sackcloth and ashes
 - went out into the midst of the city
 - cried out with a loud and bitter voice
 - all of the above

TRUE OR FALSE:

2. "And in every province where the king's command and decree arrived, there was great mourning amongst the Jews, with fasting, weeping, and wailing; and many lay in sackcloth and ashes." ESTHER 4:3
TRUE OR FALSE
3. Mordecai sent a copy of the decree "which was given at Shushan, that he might show it to Esther and explain it to her, and that he might command her to go in to the king to make supplication to him and plead before him for her people." ESTHER 4:8
TRUE OR FALSE

CIRCLE THE CORRECT WORDS:

4. Esther sent back to Mordecai, "All the king's servants and the people of the king's provinces know that any man or woman who goes into the inner court to the king, who has not been called, he has but one law: put all to **(BED, DEATH)**, except the one to whom the king holds out the golden scepter, that he may **(LAUGH, LIVE)**." ESTHER 4:11

FILL IN THE BLANKS:

5. "Then Mordecai told them to answer Esther: 'Do not think in your heart that you _____ escape in the king's palace any more than all the other Jews. For if you remain completely silent at _____ time, relief and deliverance _____ arise for the Jews from another place, but you and your father's house _____ perish. Yet who knows whether you have come to the kingdom for such a time as _____?' " ESTHER 4:13-14

CIRCLE THE CORRECT WORDS:

6. "Then Esther told them to return this answer to Mordecai: 'Go, gather all the Jews who are present in Shushan, and **(FAST, CRY)** for me; neither eat nor drink for three days, night or day. My maids and I will **(CRY, FAST)** likewise. And so I will go to the king, which is against the law; and if I perish, I perish.'" ESTHER 4:15-16

129. ESTHER PLEADS FOR HER PEOPLE (ESTHER 4:1-17)

M A A D J K L V Z M M O C I Z
 O S V J O C A Q L X G N I K F
 U H D I U R P D U N C A D G E
 R E Q P G Y G N I L I A W N I
 N S I A C E D R O M C T T I L
 I W E T S K P V T E V M M P E
 N K N T F A A S M O S Z L E R
 G I H V K T N M O B Z C G E V
 O E C N A R E V I L E D A W F
 R J R R D G N I T S A F E P R
 K S H C A H T A H N K J D K E
 Q P A L A C E C E L F S A R K
 S A C K C L O T H P K M E P K
 K P Y F B W S W E J S N L P Y
 L E Y E H S I R E P M P P U R

ASHES	FASTING	MOURNING	RELIEF
CRY	HATHACH	PALACE	SACKCLOTH
DELIVERANCE	JEWS	PERISH	WAILING
ESCAPE	KING	PLEAD	WEEPING
ESTHER	MORDECAI		

WRITE THE LETTERS ON THE LINES BELOW
AS YOU WORK YOUR WAY TO THE CENTER OF THE CIRCLE

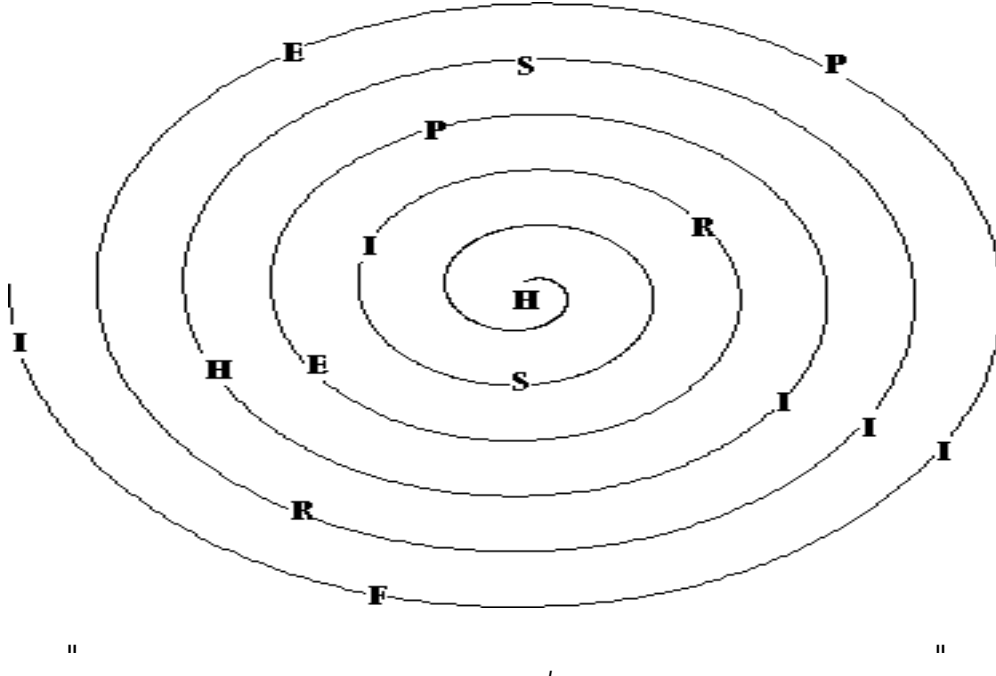

129. ESTHER PLEADS FOR HER PEOPLE

(ESTHER 4:1-17)

MEMORY VERSE:

"And so I will go to the king, which is against the law, and if I perish, I perish." ESTHER 4:16

UNDERLINE THE CORRECT ANSWER:

1. "When Mordecai learned all that had happened, he..." **ESTHER 4:1**
 - a. tore his clothes
 - b. put on sackcloth and ashes
 - c. went out into the midst of the city
 - d. cried out with a loud and bitter voice
 - e. all of the above

TRUE OR FALSE:

2. "And in every province where the king's command and decree arrived, there was great mourning amongst the Jews, with fasting, weeping, and wailing; and many lay in sackcloth and ashes." **ESTHER 4:3**
TRUE OR FALSE
3. So Esther's maids and eunuchs came and told her, and the queen was very happy. Then she sent more sackcloth and ashes to Mordecai and told him to continue all that he was doing. **ESTHER 4:4**
TRUE OR FALSE

FILL IN THE BLANKS:

4. Mordecai sent a copy of the decree "which was given at Shushan, that he might show it to Esther and explain it to her, and that he might command her to go in to the king to make _____ to him and _____ before him for her people." **ESTHER 4:8**
5. Esther sent back to Mordecai, "All the king's servants and the people of the king's provinces know that any man or woman who goes into the inner court to the king, who has not been called, he has but one law: put all to _____, except the one to whom the king holds out the golden scepter, that he may _____." **ESTHER 4:11**
6. "Then Mordecai told them to answer Esther: 'Do not think in your heart that you _____ escape in the king's palace any more than all the other Jews. For if you remain completely silent at _____ time, relief and deliverance _____ arise for the Jews from another place, but you and your father's house _____ perish. Yet who knows whether you have come to the kingdom for such a time as _____?' " **ESTHER 4:13-14**

CIRCLE THE CORRECT WORDS:

7. "Then Esther told them to return this answer to Mordecai: 'Go, gather all the Jews who are present in Shushan, and (**FAST, CRY**) for me; neither eat nor drink for three days, night or day. My maids and I will (**CRY, FAST**) likewise. And so I will go to the king, which is against the law; and if I perish, I perish.' " **ESTHER 4:15-16**

129. ESTHER PLEADS FOR HER PEOPLE (ESTHER 4:1-17)

S M Q H A C E R M W R B O J U E Q Q K Z F E V Y P
 I H S I R E P I N Y G U I T D V L E D L K I X Q J
 L H I P N Q J L S P N K T P S W K N B U S K O D P
 S L P J M I Z S V Z G C E L E G A R K T M X U C Q
 J D H T G W Z T O W Z U J J S A N I K M O P V M X
 F R Z B F Z K B J B J M K C C R D I L O A P Z P Q
 F F I I H K C A J M P D K V A L D Y P I T U A O F
 O E A G N I N R U O M L P T P W O Y A E N Z U E G
 P U V S A K T Y E W N S Z W E J K D T E E G E A A
 E W V A T Q I D A U U V Y H J U Q J W M M W F Y M
 O J B M W I A Y J F O R Y P H O H C A H T A H U M
 P N Q M N E N O W E F C D J Q F K I L X Z V P H A
 A S Y T L J O G L I W M O E E E L P A N J F T A O
 L Z E P P B T F Z X L S J I L P W T P O S R O E K
 A K H T O L C K C A S L L H O I K V P B M K N C C
 C B L Y E B A V X G L E F Q E T V R A U X K I N Y
 E Z N L S R N X P Y R B A O W C I E X L C Y J A U
 O F V I G B R S S P M X H A E S J F R P P R J I D
 C H Q O D K P V J E S A A W B C S R V A C R Y Z Y
 F N T V E E I M H Y H C H V K H E E Q M N G Y S G
 M O R D E C A I G B Z S Z M S H U J D C D C T N T
 K G A Q P F Q A E D F W A J T U E O V C T I E C I
 B X Q Z Z J D Z U R P J Y S U E A U S V B K H Z I
 Y G G N I K J S W C G U E S H C V G M Z B U G X P
 N R F U C T Q H D G K K N W P N D N C B G A F R G

ASHES
 CRY
 DELIVERANCE
 ESCAPE
 ESTHER

FASTING
 HATHACH
 JEWS
 KING
 MORDECAI

MOURNING
 PALACE
 PERISH
 PLEAD

RELIEF
 SACKCLOTH
 WAILING
 WEEPING

WRITE THE LETTERS ON THE LINES BELOW
 AS YOU WORK YOUR WAY TO THE CENTER OF THE CIRCLE

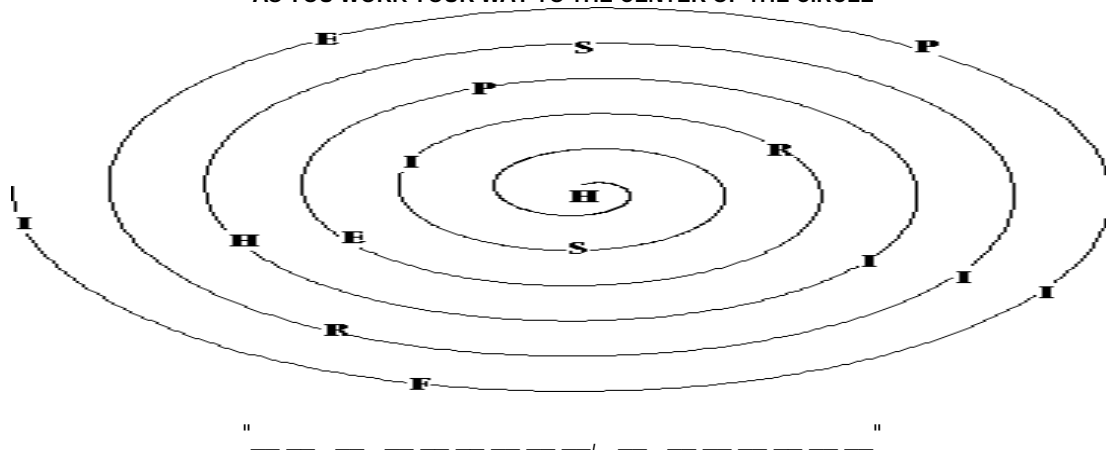

129. ESTHER PLEADS FOR HER PEOPLE (ESTHER 4:1-17)

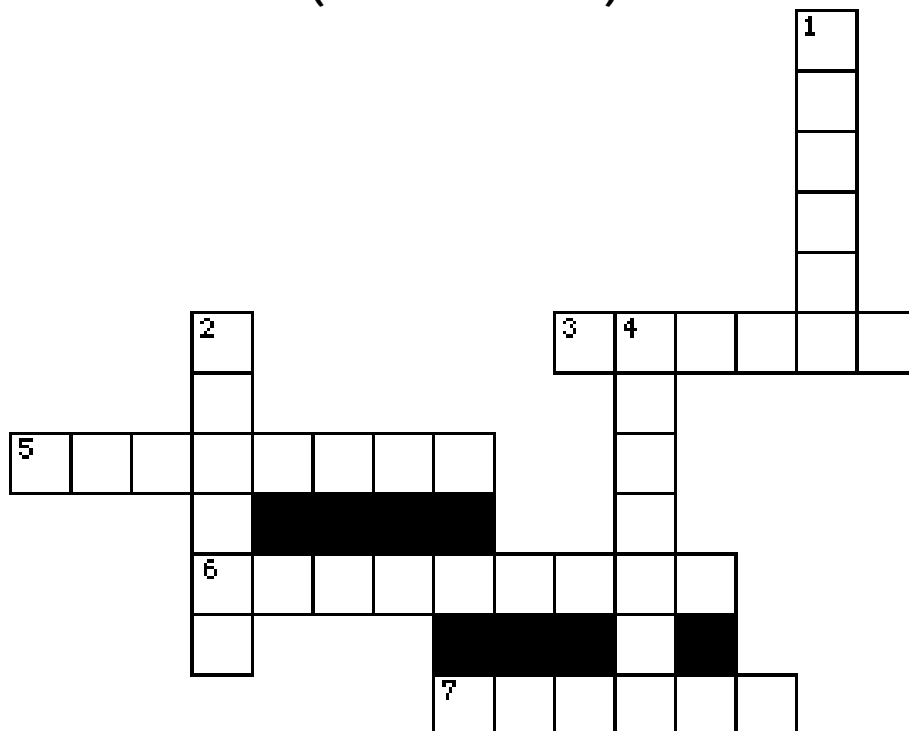

- 2 DOWN "And so I will go to the king, which is against the law, and if I _____, I perish." **ESTHER 4:16**
- 6 ACROSS "When Mordecai learned all that had happened, he tore his clothes and put on _____ and ashes, and went out into the midst of the city." **ESTHER 4:1**
- 5 ACROSS "And in every province where the king's command and decree arrived, there was great _____ amongst the Jews, with fasting, weeping, and wailing; and many lay in sackcloth and ashes." **ESTHER 4:3**
- 7 ACROSS Mordecai sent a copy of the _____ "which was given at Shushan, that he might show it to Esther and explain it to her, and that he might command her to go in to the king to make supplication to him and plead before him for her people." **ESTHER 4:8**
- 4 DOWN Esther sent back to Mordecai, "All the king's servants and the people of the king's provinces know that any man or woman who goes into the inner court to the king, who has not been called, he has but one law: put all to death, except the one to whom the king holds out the golden _____, that he may live." **ESTHER 4:11**
- 1 DOWN "Then Mordecai told them to answer Esther: 'Do not think in your heart that you will escape in the king's _____ any more than all the other Jews. For if you remain completely silent at this time, relief and deliverance will arise for the Jews from another place, but you and your father's house will perish. Yet who knows whether you have come to the kingdom for such a time as this?'" **ESTHER 4:13-14**
- 3 ACROSS "Then _____ told them to return this answer to Mordecai: 'Go, gather all the Jews who are present in Shushan, and fast for me; neither eat nor drink for three days, night or day. My maids and I will fast likewise. And so I will go to the king, which is against the law; and if I perish, I perish.'" **ESTHER 4:15-16**

Bible Story 130

**HAMAN'S ANGER
AT MORDECAI**

ESTHER 5:1-14

130. HAMAN'S ANGER AT MORDECAI (ESTHER 5:1-14)

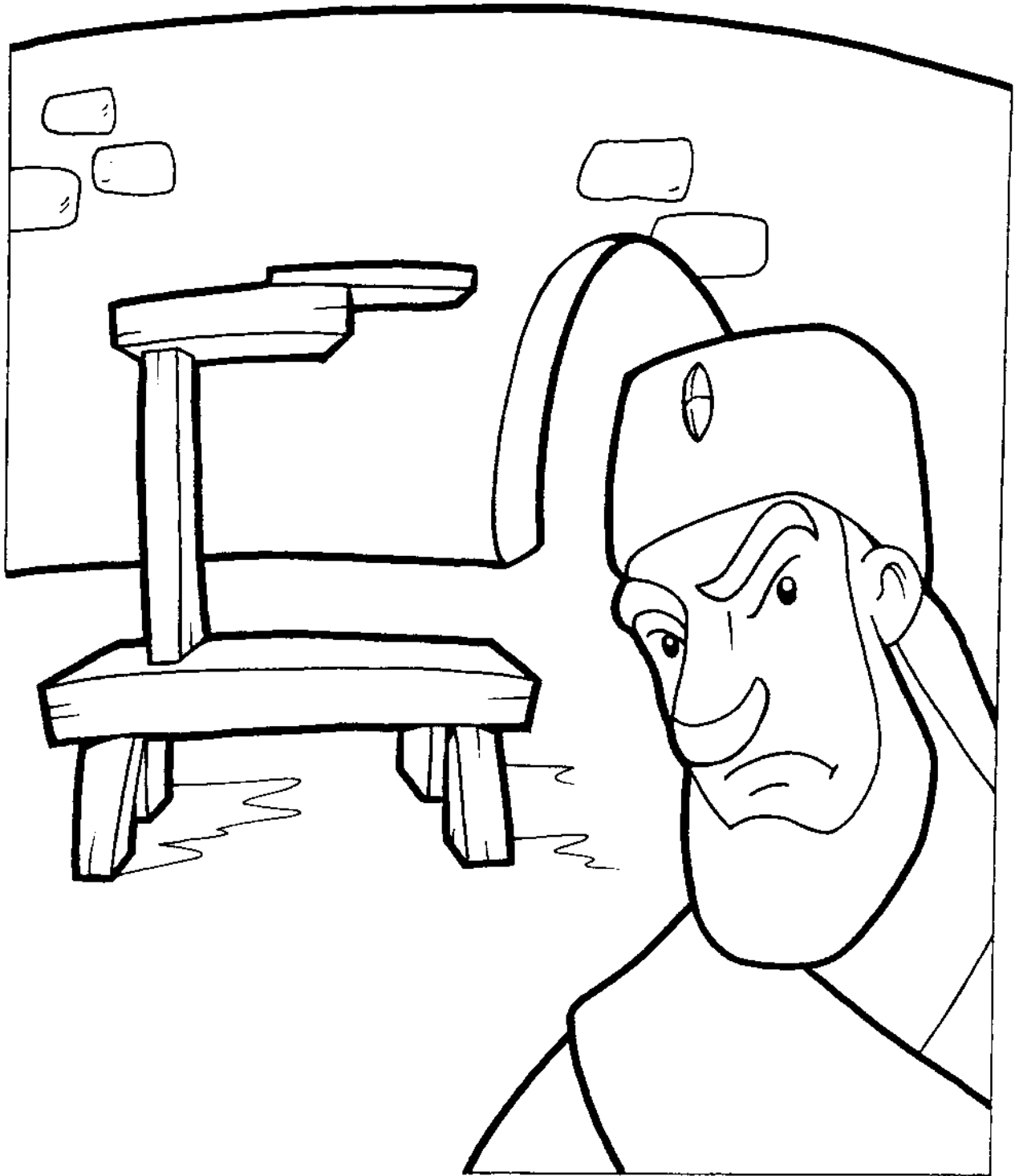

"Then said Zeresh his wife and all his friends unto him, Let a gallows be made of fifty cubits high, and to morrow speak thou unto the king that Mordecai may be hanged thereon: then go thou in merrily with the king unto the banquet. And the thing pleased Haman; and he caused the gallows to be made."

ESTHER 5:14

130. HAMAN'S ANGER AT MORDECAI (ESTHER 5:1-14)

MEMORY VERSE:

"He who troubles his own house will inherit the wind, and the fool will be the servant to the wise of heart." PROVERBS 11:29

FILL IN THE BLANKS:

1. "Now it happened on the third day that Esther put on her _____ robes and stood in the inner court of the king's palace, across from the king's house, while the king sat on his _____ throne in the _____ house, facing the entrance of the house." **ESTHER 5:1**

TRUE OR FALSE:

2. "So it was, when the king saw Queen Esther standing in the court, that she found favor in his sight, and the king held out to Esther the golden scepter that was in his hand." **ESTHER 5:2**
TRUE OR FALSE
3. Esther said, "If I have found favor in the sight of the king, and if it pleases the king to grant my petition and fulfill my request, then let the king and Haman come to the banquet which I will prepare for them, and tomorrow I will do as the king has said." **ESTHER 5:8**
TRUE OR FALSE
4. "So Haman went out that day joyful and with a glad heart; but when Haman saw Mordecai in the king's gate, and that he did not stand or tremble before him, he was filled with indignation against Mordecai." **ESTHER 5:9**
TRUE OR FALSE

UNDERLINE ALL OF THE CORRECT ANSWERS:

5. "Nevertheless Haman..." **ESTHER 5:10-11**
- | | |
|--|--------------------|
| * restrained himself and went home | ESTHER 5:10 |
| * sent and called for his friends | ESTHER 5:10 |
| * and his wife Mudpie | ESTHER 5:10 |
| * told of his great riches | ESTHER 5:11 |
| * the multitude of his chickens | ESTHER 5:11 |
| * all the ways which the king had promoted him | ESTHER 5:11 |
| * how he had advanced him above the officials and servants of the king | ESTHER 5:11 |

TRUE OR FALSE:

6. "Moreover Haman said, 'Besides, Queen Esther invited no one but me to come in with the king to the banquet that she prepared; and tomorrow I am again invited by her, along with the king.'" **ESTHER 5:12**
TRUE OR FALSE

CIRCLE THE CORRECT WORDS:

7. "Yet all this avails me (**NOTHING, EVERYTHING**), so long as I see Mordecai the Jew sitting at the king's gate." **ESTHER 5:13**
8. "Then his wife (**MUDPIE, ZERESH**) and all his (**ENEMIES, FRIENDS**) said to him, 'Let a gallows be made, fifty cubits high, and in the morning suggest to the king that Mordecai be hanged on it; then go merrily with the king to the banquet.' And the thing (**PLEASED, DISPLEASED**) Haman; so he had the gallows made." **ESTHER 5:14**

130. HAMAN'S ANGER AT MORDECAI (ESTHER 5:1-14)

O X B O I I F R L B M K A I X
 A R O V A F O H J J J M U S I
 P S H T S Y O X G H H A M A N
 A E J E A B E M O R D E C A I
 Z J B L H R P V L T Q L V G Z
 E O Y W J W K S D E N O R H T
 R R E Q U E S T E J T U A J F
 E M K N D G J U N Y R G E P Z
 S G P O U T F R S R A C S Z T
 H O G I O K Y E C D E V W F E
 D V K T L W S H E C H U O B U
 Y S G I O T T U P G L B L L Q
 S P P T H I W Q T S J N L K N
 M T S E U U U T E Q T H A M A
 U W R P I M G P R U W X G Z B

BANQUET
 ESTHER
 FAVOR
 GALLOWS

GOLDEN SCEPTER
 HAMAN
 HEART
 MORDECAI

PETITION
 REQUEST
 ROBES

ROYAL
 THRONE
 ZERESH

FOLLOW THE LINE AND WRITE DOWN THE LETTERS AS YOU COME TO THEM

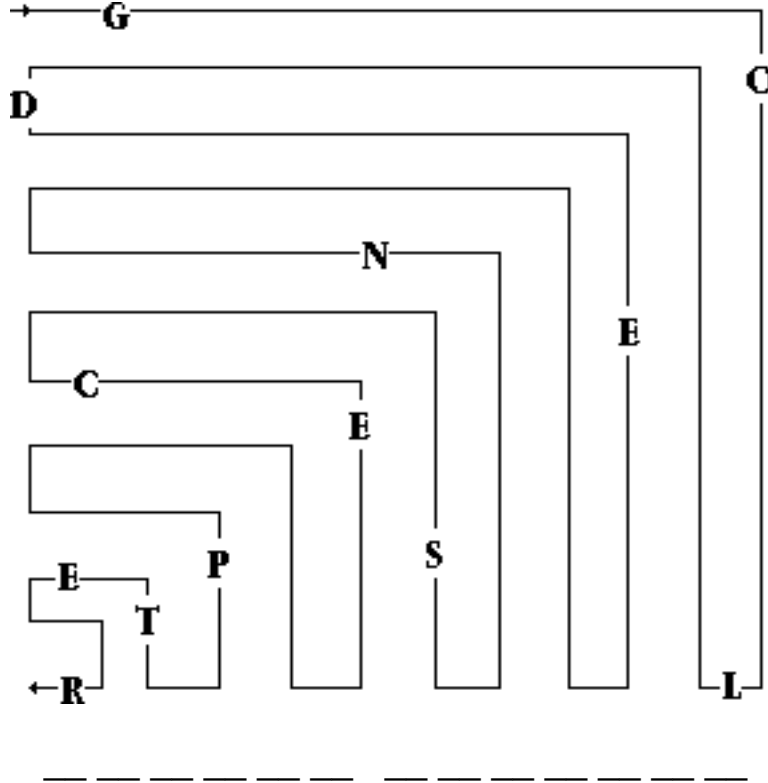

130. HAMAN'S ANGER AT MORDECAI (ESTHER 5:1-14)

MEMORY VERSE:

"He who troubles his own house will inherit the wind, and the fool will be the servant to the wise of heart." PROVERBS 11:29

FILL IN THE BLANKS:

1. "Now it happened on the third day that Esther put on her _____ robes and stood in the inner court of the king's palace, across from the king's house, while the king sat on his _____ throne in the _____ house, facing the entrance of the house." **ESTHER 5:1**
2. "So it was, when the king saw Queen Esther standing in the court, that she found _____ in his sight, and the king held out to Esther the _____ that was in his hand." **ESTHER 5:2**
3. Esther said, "If I have found favor in the sight of the king, and if it pleases the king to grant my petition and fulfill my request, then let the king and Haman come to the _____ which I will prepare for them, and tomorrow I will do as the king has said." **ESTHER 5:8**

TRUE OR FALSE:

4. "So Haman went out that day joyful and with a glad heart; but when Haman saw Mordecai in the king's gate, and that he did not stand or tremble before him, he was filled with indignation against Mordecai."
ESTHER 5:9

TRUE OR FALSE

UNDERLINE ALL OF THE CORRECT ANSWERS:

5. "Nevertheless Haman..." **ESTHER 5:10-11**
 - * restrained himself and went home **ESTHER 5:10**
 - * sent and called for his friends **ESTHER 5:10**
 - * and his wife Mudpie **ESTHER 5:10**
 - * told of his great riches **ESTHER 5:11**
 - * the multitude of his chickens **ESTHER 5:11**
 - * all the ways which the king had promoted him **ESTHER 5:11**
 - * how he had advanced him above the officials and servants of the king **ESTHER 5:11**

TRUE OR FALSE:

6. "Moreover Haman said, 'Besides, Queen Esther invited no one but me to come in with the king to the banquet that she prepared; and tomorrow I am again invited by her, along with the king.'" **ESTHER 5:12**

TRUE OR FALSE

FILL IN THE BLANKS:

7. "Yet all this avails me _____, so long as I see Mordecai the Jew sitting at the king's gate."
ESTHER 5:13
8. "Then his wife _____ and all his _____ said to him, 'Let a gallows be made, fifty cubits high, and in the morning suggest to the king that Mordecai be hanged on it; then go merrily with the king to the banquet.' And the thing pleased Haman; so he had the _____ made." **ESTHER 5:14**

130. HAMAN'S ANGER AT MORDECAI (ESTHER 5:1-14)

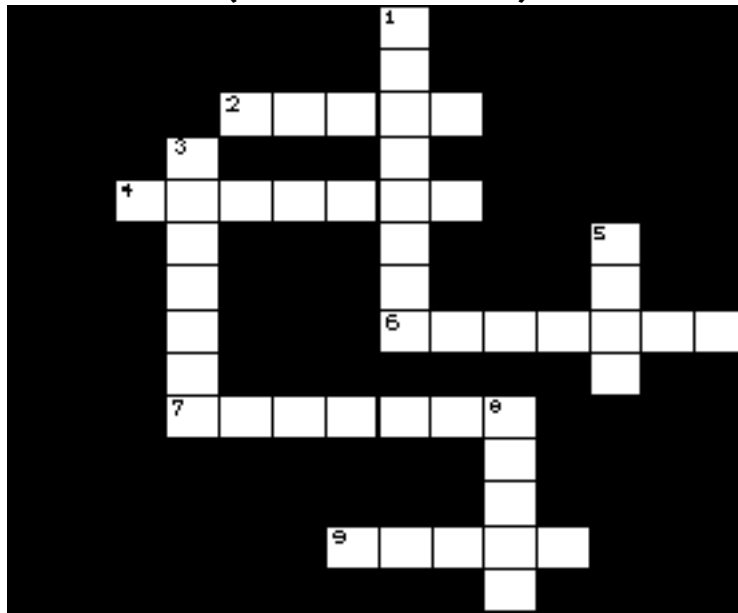

- 2 ACROSS "He who troubles his own house will inherit the wind, and the fool will be the servant to the wise of ____." **PROVERBS 11:29**
- 8 DOWN "Now it happened on the third day that Esther put on her ____ robes and stood in the inner court of the king's palace, across from the king's house, while the king sat on his royal throne in the royal house, facing the entrance of the house." **ESTHER 5:1**
- 7 ACROSS "So it was, when the king saw Queen Esther standing in the court, that she found favor in his sight, and the king held out to Esther the golden ____ that was in his hand." **ESTHER 5:2**
- 4 ACROSS Esther said, "If I have found favor in the sight of the king, and if it pleases the king to grant my petition and fulfill my request, then let the king and Haman come to the ____ which I will prepare for them, and tomorrow I will do as the king has said." **ESTHER 5:8**
- 1 DOWN "So Haman went out that day joyful and with a glad heart; but when Haman saw ____ in the king's gate, and that he did not stand or tremble before him, he was filled with indignation against Mordecai." **ESTHER 5:9**
- 9 ACROSS "Nevertheless ____ restrained himself and went home, sent and called for his friends and his wife Zeresh." **ESTHER 5:10**
- 6 ACROSS "Moreover Haman said, 'Besides, Queen Esther invited no one but me to come in with the king to the banquet that she prepared; and tomorrow I am again ____ by her, along with the king.'" **ESTHER 5:12**
- 5 DOWN "Yet all this avails me nothing, so long as I see Mordecai the Jew sitting at the king's ____." **ESTHER 5:13**
- 3 DOWN "Then his wife Zeresh and all his friends said to him, 'Let a gallows be made, fifty cubits high, and in the morning suggest to the king that Mordecai be hanged on it; then go merrily with the king to the banquet.' And the thing pleased Haman; so he had the ____ made." **ESTHER 5:14**

Bible Story 131

MORDECAI IS HONORED

ESTHER 6:1-14

131. MORDECAI IS HONORED

(ESTHER 6:1-14)



"Then took Haman the apparel and the horse, and arrayed Mordecai, and brought him on horseback through the street of the city, and proclaimed before him, Thus shall it be done unto the man whom the king delighteth to honour."

ESTHER 6:11

131. MORDECAI IS HONORED

(ESTHER 6:1-14)

MEMORY VERSE:

"Pride goes before destruction and a haughty spirit before a fall." PROVERBS 16:18

CIRCLE THE CORRECT WORDS:

1. "That night the king could not (**EAT**, **SLEEP**). So one was commanded to bring the book of the records of the chronicles; and they were (**TORN**, **READ**) before the king." **ESTHER 6:1**
2. "And it was found written that (**MORDECAI**, **HAMAN**) had told of Bigthana and Teresh, two of the king's eunuchs, the doorkeepers who had sought to lay hands on King Ahasuerus." **ESTHER 6:2**

TRUE OR FALSE:

3. "Then the king said, 'What honor or dignity has been bestowed on Mordecai for this?' And the king's servants who attended him said, 'Nothing has been done for him.'" **ESTHER 6:3**

TRUE OR FALSE

CIRCLE THE CORRECT WORD:

4. When Haman came in, "the king asked him, 'What shall be done for the man whom the king delights to honor?' Now Haman thought in his heart, 'Whom would the king delight to honor more than (**MORDECAI**, **ME**)?' " **ESTHER 6:6**

UNDERLINE THE CORRECT ANSWER:

5. "Haman answered the king, 'For the man whom the king delights to honor,...' " **ESTHER 6:7-9**
 - a. let a robe be brought which the king has worn **ESTHER 6:8**
 - b. let a horse be brought on which the king has ridden **ESTHER 6:8**
 - c. the horse has a royal crest placed on its head **ESTHER 6:8**
 - d. let the robe and horse be delivered to the hand of one of the king's most noble princes **ESTHER 6:9**
 - e. parade him on horseback through the city square **ESTHER 6:9**
 - f. proclaim before him, "Thus shall it be done to the man whom the king delights to honor!" **ESTHER 6:9**
 - g. all of the above

TRUE OR FALSE:

6. Then the king said to Haman, "Behold, you are the man whom I delight to honor!" **ESTHER 6:10**

TRUE OR FALSE

7. "Afterward Mordecai went back to the king's gate. But Haman hastened to his house, mourning and with his head covered." **ESTHER 6:12**

TRUE OR FALSE

FILL IN THE BLANKS:

8. "When Haman told his wife Zeresh and all his friends everything that had happened to him, his wise men and his wife Zeresh said to him, 'If Mordecai, before whom you have begun to fall, is of Jewish descent, you will not prevail _____ him but will surely fall _____ him.'" **ESTHER 6:13**

131. MORDECAI IS HONORED

(ESTHER 6:1-14)

C N L H F D T N H N E Y G K K
T D B I E D A A T K P F W G R
C G Z C F R A Y T B I O A H E
J R N U H Q A N O T H I N G N
W A Z I T R H U R C Y J F G C
Y Z N A N C O A Q E B O R D V
J E K P Q R S N M S B W U V C
T M O I A U U T I A Y S T B C
N D B A H R U O H C N T O G E
A W H C A J A Q M G L S I C S
S Q F E H K E D R K I E M C R
L N V D U O N U E D I L S Z O
P I I R U S N Q W W B N E H H
U T A O T M Q O P K H I G D H
T N N M T J X I R I P A J K R

CHRONICLES

CITY SQUARE

DELIGHTS

HAMAN

HONOR

HORSE

KING

MORDECAI

MOURNING

NOTHING

PARADE

ROBE

131. MORDECAI IS HONORED

(ESTHER 6:1-14)

MEMORY VERSE:

"Pride goes before destruction and a haughty spirit before a fall." **PROVERBS 16:18**

FILL IN THE BLANKS:

1. "That night the king could not _____. So one was commanded to bring the book of the records of the chronicles; and they were _____ before the king." **ESTHER 6:1**
2. "And it was found written that _____ had told of Bigthana and Teresh, two of the king's eunuchs, the doorkeepers who had sought to lay hands on King Ahasuerus." **ESTHER 6:2**

TRUE OR FALSE:

3. "Then the king said, 'What honor or dignity has been bestowed on Mordecai for this?' And the king's servants who attended him said, 'Nothing has been done for him.'" **ESTHER 6:3**

TRUE OR FALSE

FILL IN THE BLANKS:

4. When Haman came in, "the king asked him, 'What shall be done for the man whom the king delights to honor?' Now Haman thought in his heart, 'Whom would the king delight to honor more than _____?' " **ESTHER 6:6**
5. "Haman answered the king, 'For the man whom the king delights to honor,...' " **ESTHER 6:7-9**
 - a. let a robe be brought which the king has _____ **ESTHER 6:8**
 - b. let a horse be brought on which the king has _____ **ESTHER 6:8**
 - c. the horse has a royal _____ placed on its head **ESTHER 6:8**
 - d. let the robe and horse be delivered to the hand of one of the king's most noble _____ **ESTHER 6:9**
 - e. parade him on horseback through the _____ square **ESTHER 6:9**
 - f. proclaim before him, "Thus shall it be done to the man whom the king delights to _____!" **ESTHER 6:9**

TRUE OR FALSE:

6. Then the king said to Haman, "Behold, you are the man whom I delight to honor!" **ESTHER 6:10**

TRUE OR FALSE
7. "Afterward Mordecai went back to the king's gate. But Haman hastened to his house, mourning and with his head covered." **ESTHER 6:12**

TRUE OR FALSE
8. "When Haman told his wife Zeresh and all his friends everything that had happened to him, his wise men and his wife Zeresh said to him, 'If Mordecai, before whom you have begun to fall, is of Jewish descent, you will not prevail against him but will surely fall before him.'" **ESTHER 6:13**

TRUE OR FALSE
9. "While they were still talking with him, the king's eunuchs came and hastened to bring Haman to the banquet which Esther had prepared." **ESTHER 6:14**

TRUE OR FALSE

131. MORDECAI IS HONORED

(ESTHER 6:1-14)

B R D S E K E A E F I O P J V O J E S J R P L D A
H M C D O B E M S J L J Z P R J H B C S F V P T V
R D N J O Z D X G T S J W N C N Q K H U E Q M N M
U C W Q C F A T D E T E B U M I O S U E J D C R O
I U T I F H R Y E J F A M O L F A T E A O V C G U
W G I K K N A L P Z A W W F B A O C H H O R S E V
V D W T B G P I Z Z Y L U L N H A U E I U S V E Z
B T P G N I N R U O M Z F L A A W H C D N M Z I A
M A P D Y X L O C K Y N I M C H V P N V R G N M U
C S W Y N G N V C C O P R S W Z M E Q D G O F M E
B T Q H M R V Q Q T F J G Z J Y G N I K L C M P F
H O T U H Q Q Z I I V H C F U N F V L Q K Z K P P
P T A Q L I T U W O P G Y H K J S A K E D L S U T
D W U S D P A A Z T S E P P R T W R D N B U M Z O
E F E R A U Q S Y T I C Y G O O U L D R K T O V N
B A U S O H Q N K A V U B K I P N W O Y K M A F I
C M H I R B F M K N M W D B T L D I K Y A O T R J
P F E L E Z E G Q R A D R U E J S J C D T E M K J
O H R S U I H F J P Z W C K J C J U Q L W M Z K Y
G K J J W V P H B I S Y G C K N A M A H E M J Y T
D E L I G H T S B Q H H R U K V H O K J L S S R H
U N S F J V J A R D M O G M P T Q E L I A N M G G
P C T F N B T W B J Y N N D Z W O P W P P O X I F
M U A O S Q B N K Q S O G L Y H E T K T P B P V Y
N Q Z P Z Y I P E R V R Z S Y P W C I V A U C U Q

CHRONICLES

CITY SQUARE

DELIGHTS

HAMAN

HONOR

HORSE

KING

MORDECAI

MOURNING

NOTHING

PARADE

ROBE

131. MORDECAI IS HONORED

(ESTHER 6:1-14)

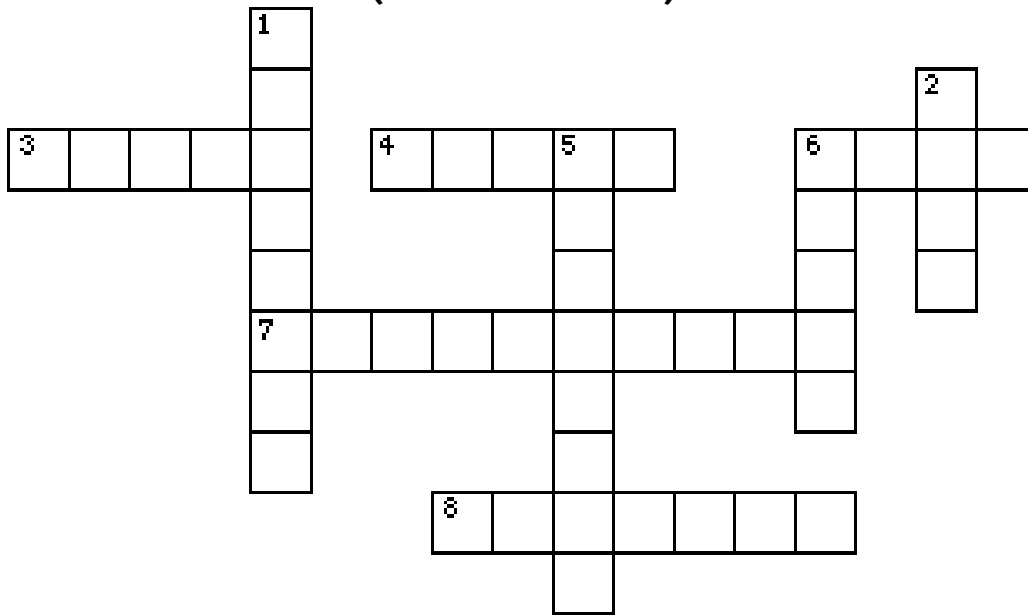

- 4 ACROSS " _____ goes before destruction and a haughty spirit before a fall." **PROVERBS 16:18**
- 7 ACROSS "That night the king could not sleep. So one was commanded to bring the book of the records of the _____; and they were read before the king." **ESTHER 6:1**
- 1 DOWN "And it was found written that _____ had told of Bigthana and Teresh, two of the king's eunuchs, the doorkeepers who had sought to lay hands on King Ahasuerus." **ESTHER 6:2**
- 8 ACROSS "Then the king said, 'What honor or dignity has been bestowed on Mordecai for this?' And the king's servants who attended him said, ' _____ has been done for him.'" **ESTH 6:3**
- 5 DOWN When Haman came in , "the king asked him, 'What shall be done for the man whom the king _____to honor?' Now Haman thought in his heart, Whom would the king delight to honor more than me?" **ESTHER 6:6**
- 3 ACROSS "Haman answered the king, 'For the man whom the king delights to _____, let a robe be brought which the king has worn, and a horse on which the king has ridden, which has a royal crest placed on its head.'" **ESTHER 6:8**
- 6 DOWN Then the king said to Haman, "Hasten, take the robe and the _____, as you have suggested, and do so for Mordecai the Jew who sits within the king's gate." **ESTHER 6:10**
- 6 ACROSS "Afterward Mordecai went back to the king's gate. But Haman hastened to his house, mourning and with his _____covered." **ESTHER 6:12**
- 2 DOWN "When Haman told his wife Zeresh and all his friends everything that had happened to him, his wise men and his wife Zeresh said to him, 'If Mordecai, before whom you have begun to fall, is of Jewish descent, you will not prevail against him but will surely _____ before him.'" **ESTHER 6:13**

131. MORDECAI IS HONORED

(ESTHER 6:1-14)

Mordecai's procession begins here

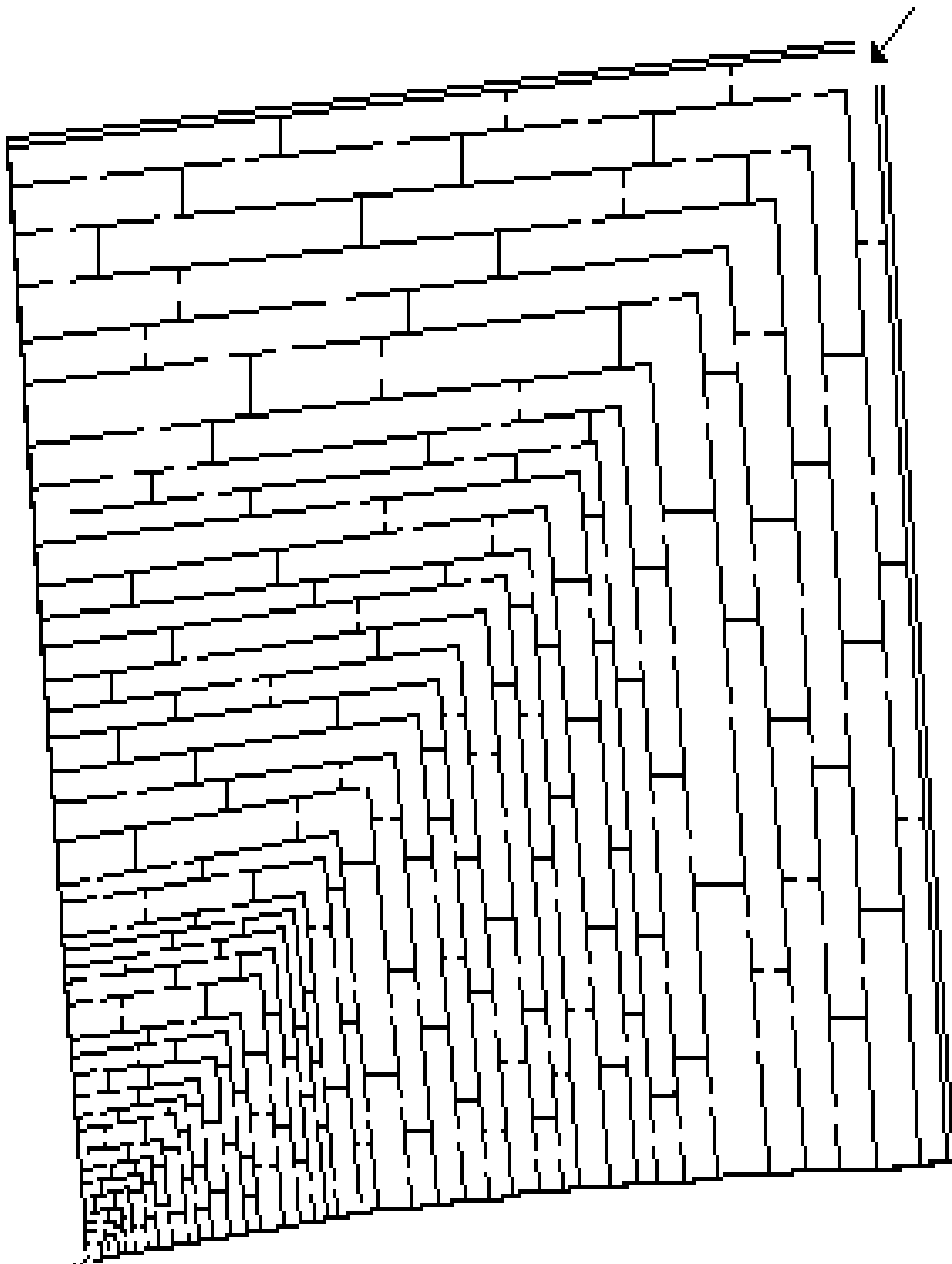

The place of honor

Bible Story 132

HAMAN'S EVIL IS REPAID

ESTHER 7:1-10

132. HAMAN'S EVIL IS REPAID (ESTHER 7:1-10)



"Then the king returned out of the palace garden into the place of the banquet of wine; and Haman was fallen upon the bed whereon Esther was. Then said the king, Will he force the queen also before me in the house? As the word went out of the king's mouth, they covered Haman's face."

ESTHER 7:8

132. HAMAN'S EVIL IS REPAID

(ESTHER 7:1-10)

MEMORY VERSE:

"Do not be overcome by evil, but overcome evil with good." ROMANS 12:21

TRUE OR FALSE:

1. "So the king and Haman went to dine with Queen Esther." **ESTHER 7:1**
TRUE OR FALSE

FILL IN THE BLANKS:

2. Queen Esther said to the king, "If I have found favor in your sight, O king, and if it pleases the king, let ____ life be given me at ____ petition, and ____ people at ____ request."
ESTHER 7:3

UNDERLINE THE CORRECT ANSWER:

3. "For we have been sold, my people and I,..." **ESTHER 7:4**
- a. to be destroyed
 - b. to be killed
 - c. to be annihilated
 - d. all of the above

CIRCLE THE CORRECT WORDS:

4. "Then King Ahasuerus answered and said to Queen Esther, 'Who is he, and where is he, who would dare presume in his (**HEAD, HEART**) to do such a thing?' " **ESTHER 7:5**
5. "And Esther said, 'The adversary and enemy is this wicked (**HAMAN, KING**)!' So Haman was (**HAPPY, TERRIFIED**) before the king and queen." **ESTHER 7:6**

TRUE OR FALSE:

6. "Then the king arose in his wrath from the banquet of wine and went into the palace garden: but Haman stood before Queen Esther, pleading for his life, for he saw that evil was determined against him by the king." **ESTHER 7:7**
TRUE OR FALSE
7. "So they hanged Haman on the gallows that he had prepared for Mordecai. Then the king's wrath subsided." **ESTHER 7:10**
TRUE OR FALSE

132. HAMAN'S EVIL IS REPAID

(ESTHER 7:1-10)

P H A N G E D C X V H A M A N
 E N E M Y B A Z N Z D L O S K
 T K J R R K X L O K M T G T Y
 I D S Y F K N E D R A G N E R
 T D I A C E D R D M Z A I U G
 I O U Y E A V U B F J L K Q I
 O K E D J T F A V O R L E N K
 N Q A J O W Q T U K S O I A U
 U D E I F I R R E T M W K B A
 E K V I U L D S L S M S H Z V
 C L D P G A T M P M P E P V X
 N W Q T F H V O M O A J P F O
 M O R D E C A I C R W R A T H
 Q K E R K P S E T A C X P R U
 L I N V D P M M C T D G U K V

BANQUET
 ENEMY
 ESTHER
 FAVOR

GALLOWS
 GARDEN
 HAMAN
 HANGED

HEART
 KING
 MORDECAI
 WRATH

PETITION
 SOLD
 TERRIFIED

You are invited to dine with the king!

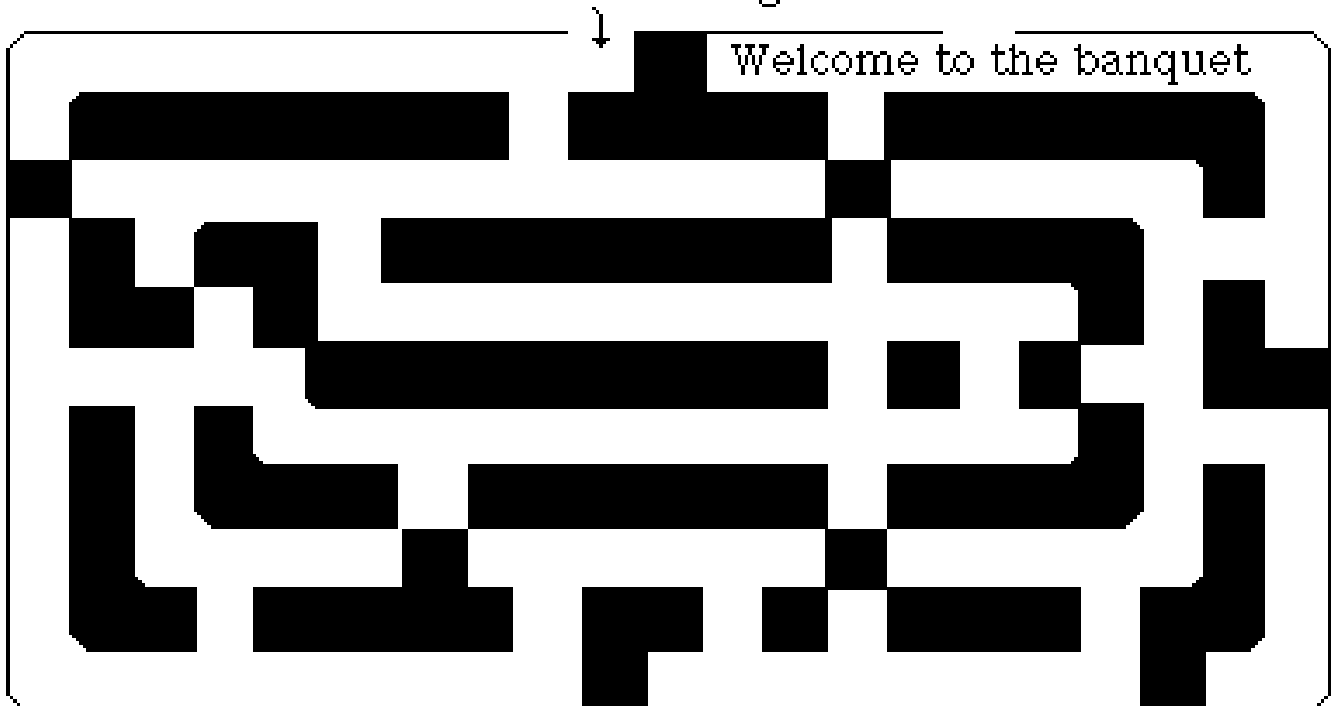

132. HAMAN'S EVIL IS REPAID

(ESTHER 7:1-10)

MEMORY VERSE:

"Do not be overcome by evil, but overcome evil with good." ROMANS 12:21

TRUE OR FALSE:

1. "So the king and Haman went to dine with Queen Esther." **ESTHER 7:1**
TRUE OR FALSE

FILL IN THE BLANKS:

2. Queen Esther said to the king, "If I have found favor in your sight, O king, and if it pleases the king, let ____ life be given me at ____ petition, and ____ people at ____ request."
ESTHER 7:3

UNDERLINE THE CORRECT ANSWER:

3. "For we have been sold, my people and I,..." **ESTHER 7:4**
- a. to be destroyed
 - b. to be killed
 - c. to be annihilated
 - d. all of the above

FILL IN THE BLANKS:

4. "Then King Ahasuerus answered and said to Queen Esther, 'Who is he, and where is he, who would dare presume in his _____ to do such a thing?' " **ESTHER 7:5**
5. "And Esther said, 'The _____ and _____ is this wicked Haman!' So Haman was _____ before the king and queen." **ESTHER 7:6**
6. "Then the king arose in his _____ from the banquet of wine and went into the palace garden: but Haman stood before Queen Esther, _____ for his life, for he saw that evil was determined against him by the king." **ESTHER 7:7**

TRUE OR FALSE:

7. "So they hanged Haman on the gallows that he had prepared for Mordecai. Then the king's wrath subsided." **ESTHER 7:10**
TRUE OR FALSE

132. HAMAN'S EVIL IS REPAID

(ESTHER 7:1-10)

S H I P N Q J R H D G B O T U V L E D L S R V C J
 I T E U Q N A B M W R U I P D A K N B U M P Z M P
 L L P J M I Z I L Y G K T L S M D R K T O P A P Q
 S D H T G W Z L S P N C E J H N O Y K M A U U O N
 J R Z B F Z K S V Z G W J C A R O R A O T Z E E Q
 F E I I H K W T O W Z M K V N L D I D E M V F A F
 F G V A A K T F J B J D K D G W O Y T E Z F P Y G
 O U A D E I F I R R E T P T E J K D T I C R T U A
 P W V L W Q I A J M P L Z W D K Q J W M T A O H M
 E J B M L J O Y E W N S Y H J U C I L X J E I A M
 O N Q R R O M Y A U U V Y P H O K I A N S K P E A
 H S Y T P E W Y W F O R K J Q E L P W O M K N C O
 A Z E Y N B T S L I F W O I O P W T P B R Y I N K
 M K L E E B A O Z X L M J H N T K V P U P R J A C
 A B N E D R A G E C A L A P E G I R A L C G J I Y
 N Z N L S R N F X G L L F Q W C A F R P D I Y Z U
 O F V I G B R V P Y M B A O E S J H V M S K T S D
 C H Q O D K P X R P S X H A B C S E A C T O H N Y
 F N T V E E I S J O Z A A W K H U H Q S R U L C G
 K G A Q P F Q V H Y V C H V S U T J D C L A G D T
 Q U E E N E S T H E R A Z M U A E O V V J E F Z I
 B V Q Z Z J D M G B F W F F R E A U S Z G V R J I
 Y G F W C T J A E D P J Y W H C V G M W E R Y U P
 N R T R A E H Z U R G U N S P N D F C F I O Q R S
 M Q H A C E Q S W C W W J W E Q Q K Z O O U D P G

BANQUET
 ENEMY
 FAVOR
 GALLOWS

HAMAN
 HANGED
 HEART
 KING AHASUERUS

MORDECAI
 PALACE GARDEN
 PETITION
 QUEEN ESTHER

SOLD
 TERRIFIED
 WICKED
 WRATH

You are invited to dine with the king!

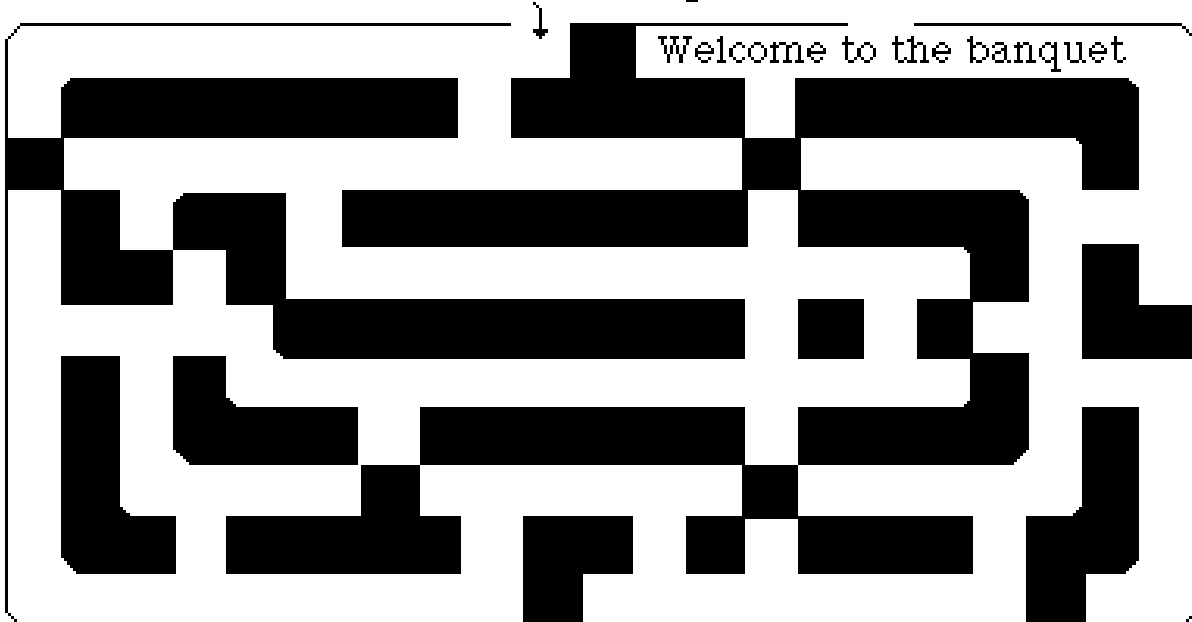

132. HAMAN'S EVIL IS REPAID

(ESTHER 7:1-10)

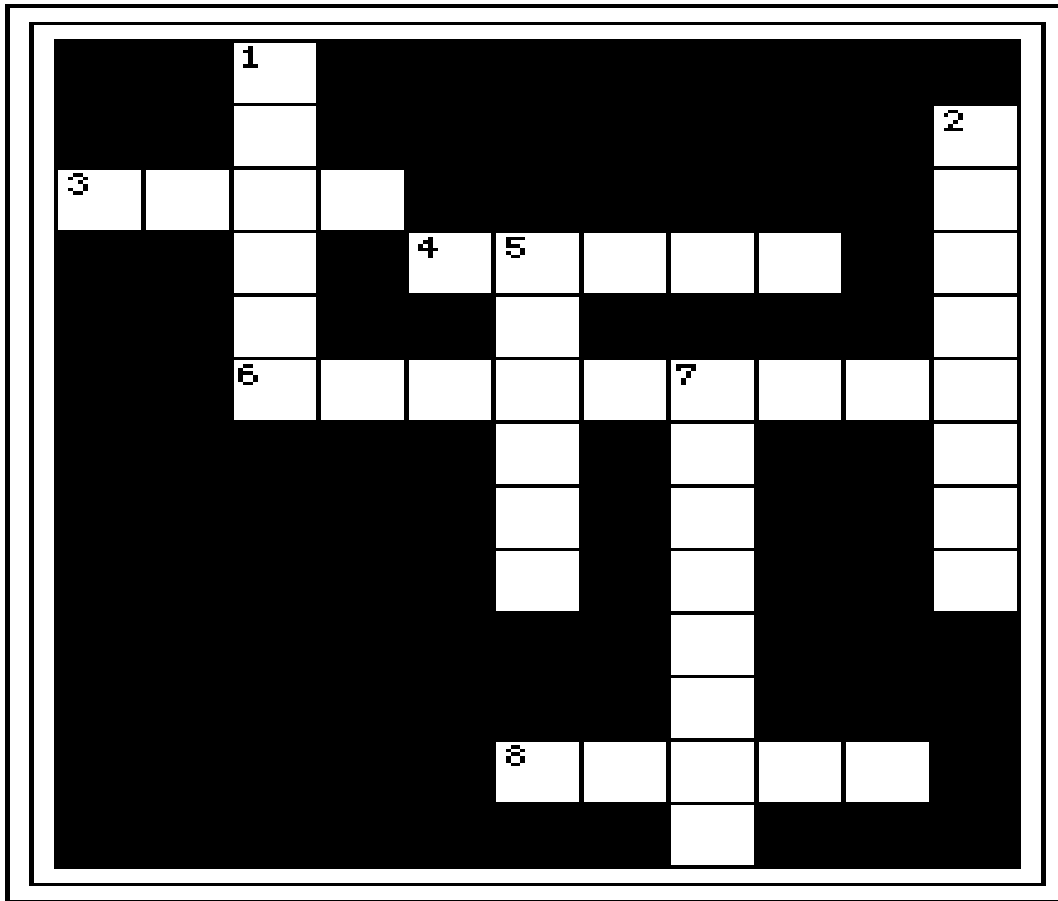

- 7 DOWN "Do not be _____ by evil, but overcome evil with good." **ROMANS 12:21**
- 5 DOWN "So the king and Haman went to dine with Queen _____." **ESTHER 7:1**
- 3 ACROSS Queen Esther said to the _____, "If I have found favor in your sight, O king, and if it pleases the king, let my life be given me at my petition, and my people at my request." **ESTHER 7:3**
- 6 ACROSS "For we have been sold, my people and I, to be _____ to be killed and to be annihilated." **ESTHER 7:4**
- 4 ACROSS "Then King Ahasuerus answered and said to Queen Esther, 'Who is he, and where is he, who would dare presume in his _____ to do such a thing?' " **ESTHER 7:5**
- 8 ACROSS "And Esther said, 'The adversary and enemy is this wicked _____!' So Haman was terrified before the king and queen." **ESTHER 7:6**
- 2 DOWN "Then the king arose in his wrath from the banquet of wine and went into the palace garden: but Haman stood before Queen Esther, _____ for his life, for he saw that evil was determined against him by the king." **ESTHER 7:7**
- 1 DOWN "So they _____ Haman on the gallows that he had prepared for Mordecai. Then the king's wrath subsided." **ESTHER 7:10**

Bible Story 133

ESTHER SAVES HER PEOPLE

ESTHER 8:1-17

133. ESTHER SAVES HER PEOPLE

(ESTHER 8:1-17)



"On that day did the king Ahasuerus give the house of Haman the Jews' enemy unto Esther the queen. And Mordecai came before the king; for Esther had told what he was unto her."

ESTHER 8:1

133. ESTHER SAVES HER PEOPLE

(ESTHER 8:1-17)

MEMORY VERSE:

"When it goes well with the righteous, the city rejoices; and when the wicked perish, there is shouting." PROVERBS 11:10

TRUE OR FALSE:

1. "King Ahasuerus gave Queen Esther the house of Haman, the enemy of the Jews. And Mordecai came before the king, for Esther had told how he was related to her." **ESTHER 8:1**
TRUE OR FALSE
2. "So the king took off his signet ring, which he had taken from Haman, and gave it to Mordecai; and Esther appointed Mordecai over the house of Haman." **ESTHER 8:2**
TRUE OR FALSE

CIRCLE THE CORRECT WORDS:

3. The king said to Queen Esther and Mordecai, "You yourselves write a decree for the Jews, as you please, in the king's name, and seal it with the king's signet (**HAT, RING**); for a letter which is written in the king's name and sealed with the king's signet (**WATCH, RING**) no one can revoke." **ESTHER 8:8**
4. "By these letters the king permitted the Jews who were in every city to gather together and (**SURRENDER, PROTECT**) their lives." **ESTHER 8:11**

UNDERLINE THE CORRECT ANSWER:

5. "Now Mordecai went out from the presence of the king..." **ESTHER 8:15**
 - a. in royal apparel of blue and white
 - b. with a great crown of gold
 - c. and a garment of fine linen and purple
 - d. all of the above

CIRCLE THE CORRECT WORDS:

6. "The Jews had..." **ESTHER 8:16**
LIGHT GLADNESS SADNESS MADNESS JOY HONOR

TRUE OR FALSE:

7. "And in every province and city, wherever the king's command and decree came, the Jews had joy and gladness, a feast and a holiday. Then many of the people of the land became Jews, because fear of the Jews fell upon them." **ESTHER 8:17**
TRUE OR FALSE

133. ESTHER SAVES HER PEOPLE

(ESTHER 8:1-17)

K X K A L P L S J E V P N L Q
I A P H J I W W H B A T Q W R
N C Z Z G J J O Y K R C L K O
D W Y H C H S R E T T E L I N
R J T O L P L I V E R I N G O
E U Y Y V Q V U Q H O U S E H
D K O F E A R D O S L S N J E
S O J N T O M N A M A H D S N
V R E T P E C S N E D L O G K
R I L I V E E R C E D C D I R
C T T C E T O R P U W H N U Y
M E F J W A F S E H J G O E Y
G L A D N E S S W P U U L A D
L J A T H S W E J E O E Q V J
B K H P R E H T S E E C K D I

DECREE
ESTHER
EVIL
EVIL PLOT
FEAR

GLADNESS
GOLDEN SCEPTER
HAMAN
HONOR
HOUSE

JEWS
JOY
KING
KINDRED

LETTERS
LIGHT
PROTECT
RING



133. ESTHER SAVES HER PEOPLE

(ESTHER 8:1-17)

MEMORY VERSE:

"When it goes well with the righteous, the city rejoices; and when the wicked perish, there is shouting." PROVERBS 11:10

TRUE OR FALSE:

1. "King Ahasuerus gave Queen Esther the house of Haman, the enemy of the Jews. And Mordecai came before the king, for Esther had told how he was related to her." **ESTHER 8:1**
TRUE OR FALSE

UNDERLINE THE CORRECT ANSWER:

2. "So the king..." **ESTHER 8:2**
a. took off his signet ring, which he had taken from Haman
b. gave it to Mordecai
c. and Esther appointed Mordecai over the house of Haman
d. all of the above

FILL IN THE BLANKS:

3. The king said to Queen Esther and Mordecai, "You yourselves write a decree for the Jews, as you please, in the king's name, and seal it with the king's signet _____; for a letter which is written in the king's name and sealed with the king's signet _____ no one can revoke." **ESTHER 8:8**
4. "By these _____ the king permitted the Jews who were in every city to gather together and _____ their lives." **ESTHER 8:11**

UNDERLINE THE CORRECT ANSWER:

5. "Now Mordecai went out from the presence of the king..." **ESTHER 8:15**
a. in royal apparel of blue and white
b. with a great crown of gold
c. and a garment of fine linen and purple
d. all of the above

CIRCLE THE CORRECT WORDS:

6. "The Jews had..." **ESTHER 8:16**
LIGHT GLADNESS SADNESS MADNESS JOY HONOR

FILL IN THE BLANKS:

7. "And in every province and city, wherever the king's command and decree came, the Jews had ____ and _____, a feast and a holiday. Then many of the people of the land became Jews because _____ of the Jews fell upon them." **ESTHER 8:17**

133. ESTHER SAVES HER PEOPLE

(ESTHER 8:1-17)

J S D Q Q Z Z J J H W G U J C U W K J A N J F P U
S E E R C E D T Q M Y N M K V D J Q I P O S R T H
T I R R F P C E R W P G D K T K W K P P B M K O A
A L A I H A C J I S Z Z L P H S I L T A U N K N E
Z E E P P N J Z L V W J S Z A S S N V X L P Y I C
F S U H J M Q O S O B P V Y M J O E D V P C R J N
S P W Z T G I Z Y J M N R Y A H E W N R M D G J A
D J R G N I R T E N G I S O N Q P K R D E T I Y I
J F J O B F W K T J W N C J W O T I F R A D K T Z
Q F N I T H Z R F E R O M F H E C J E Q E L U H S
I O S V I E O C A A F F L A P W S S J D C T G G N
H P Z V A N C T Y W I L K H J E C U O V C P T F C
O E K B O A K T Y L X L B I H B H E U S V R A E Z
U O B H M W K I O Z G M X A N K U A G M Z G V Y L
S O R E T P E C S N E D L O G G E V F C W E B Q T
E C Z Q G V Q O F N Y S A H Q S A D K Z F P O D R
K F F Y T P J T V P P Z C Z O U C H D L K I L C P
T K H E Y E B A L J Y F W Y A H N Q A U S K U O J
D B N L L S B N S H B P J N W P Q T B S M M V M T
Y Y J N I G R R V G D G U J V E H E K T U P Z P P
Q U E E N E S T H E R K K T M G L N K M O E A O Q
H N G V W D B P M E R B O P I V K R A O A P R E M
U M X Q O S K I A U C U I L F A D Y T E T U U U Q
Q H G T V E E Q Z W G K T L S R D Y W M M Z E A S
S L R A Q P F D S D R C E J W L O D L X Z V F Y F

DECREE

FEAR

GLADNESS

GOLDEN SCEPTER

HAMAN

HONOR

HOUSE

JEWS

JOY

KINDRED

KING AHASUERUS

LETTER

LIGHT

PLOT

PROTECT

QUEEN ESTHER

SIGNET RING



133. ESTHER SAVES HER PEOPLE

(ESTHER 8:1-17)

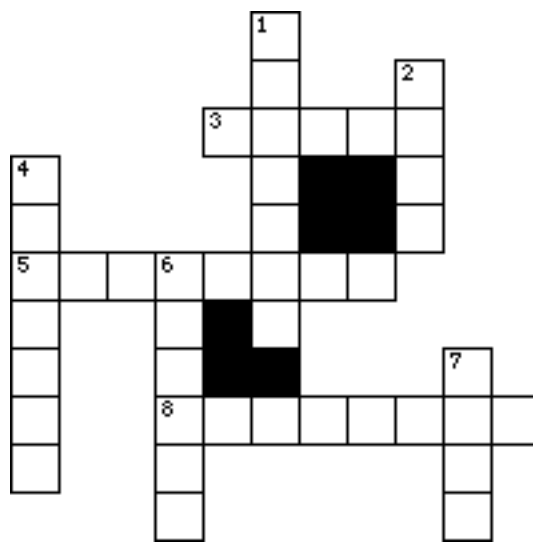

- 8 ACROSS "When it goes well with the righteous, the city _____; and when the wicked perish, there is shouting." **PROVERBS 11:10**
- 3 ACROSS "King Ahasuerus gave Queen Esther the _____ of Haman, the enemy of the Jews. And Mordecai came before the king, for Esther had told how he was related to her." **ESTHER 8:1**
- 7 DOWN "So the king took off his signet _____, which he had taken from Haman, and gave it to Mordecai; and Esther appointed Mordecai over the house of Haman." **ESTHER 8:2**
- 6 DOWN The king said to Queen Esther and Mordecai, "You yourselves write a _____ for the Jews, as you please, in the king's name, and seal it with the king's signet ring; for a letter which is written in the king's name and sealed with the king's signet ring no one can revoke." **ESTHER 8:8**
- 1 DOWN "By these letters the king permitted the Jews who were in every city to gather together and _____ their lives." **ESTHER 8:11**
- 5 ACROSS "Now _____ went out from the presence of the king in royal apparel of blue and white, with a great crown of gold and a garment of fine linen and purple." **ESTHER 8:15**
- 2 DOWN "The _____ had. light and gladness, joy and honor." **ESTHER 8:16**
- 4 DOWN "And in every province and city, wherever the king's _____ and decree came, the Jews had joy and gladness, a feast and a holiday. Then many of the people of the land became Jews, because fear of the Jews fell upon them." **ESTHER 8:17**

Bible Story 134

**THE JEWS REJOICE
& DECLARE A FEAST**

ESTHER 9:18-32

134. THE JEWS REJOICE AND DECLARE A FEAST (ESTHER 9:18-32)

" To establish this among them...As the days in which the Jews rested from their enemies, and the month which was turned unto them from sorrow to joy, and from mourning into a good day; that they should make them days of feasting and joy, and of sending portions one to another, and gifts to the poor."

ESTHER 9:21-22

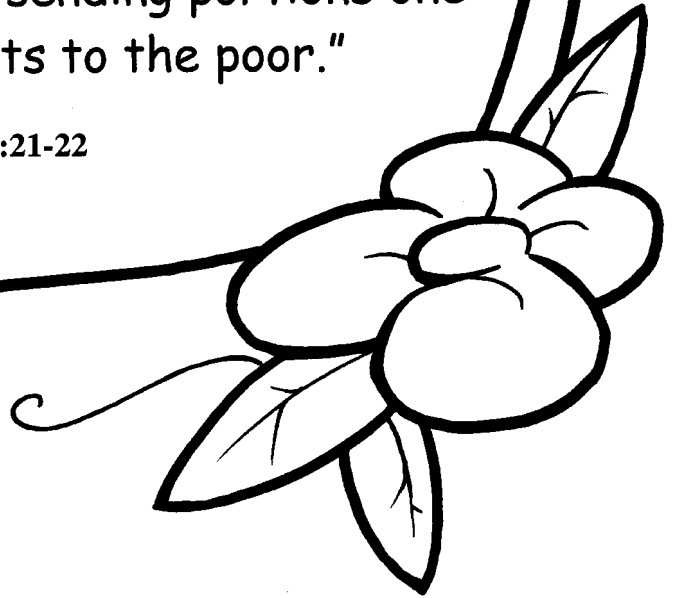
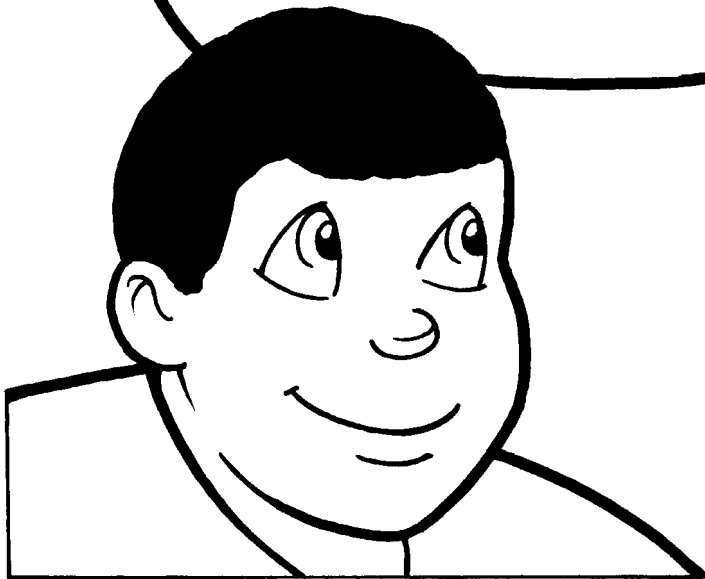

134. THE JEWS REJOICE AND DECLARE A FEAST (ESTHER 9:18-32)

MEMORY VERSE:

"Those who sow in tears shall reap in joy." PSALM 126:5

CIRCLE THE CORRECT WORDS:

1. "The Jews of the villages who dwelt in the unwalled towns celebrated the (**fourth, fourteenth**) day of the month of Adar as a day of gladness and feasting." **ESTHER 9:19**
2. This was "as a holiday, and for sending (**presents, mail**) to one another." **ESTHER 9:19**

TRUE OR FALSE: CIRCLE T OR F

3. "And Mordecai wrote these things and sent letters to all the Jews who were in the provinces of King Ahasuerus, both near and far, to establish among them that they should celebrate yearly the fourteenth and fifteenth days of the month of Adar,..." **ESTHER 9:20-21**

ESTHER 9:22

- * as the days on which the Jews had rest from their enemies T or F
- * as the month which was turned from sorrow to joy for them T or F
- * and from a holiday to mourning T or F
- * and from mourning to a holiday T or F
- * that they should make them days of feasting and joy T or F
- * of sending presents to one another T or F
- * and gifts to the rich T or F
- * and gifts to the poor T or F

CIRCLE THE CORRECT WORDS:

4. This custom was accepted because "when Esther came before the king, he commanded by letter that this wicked plot which (**Herman, Haman**) had devised against the Jews should return on his (**own, brother's**) head, and that he and his sons should be hanged on the gallows." **ESTHER 9:25**
5. "The Jews established and imposed it upon themselves and their descendants and all who should join them, that without fail they should (**celebrate, mourn**) these two days every year." **ESTHER 9:27**

FILL IN THE BLANKS:

6. "So the decree of _____ confirmed these matters of _____, and it was written in the book." **ESTHER 9:32**

134. THE JEWS REJOICE AND DECLARE A FEAST (ESTHER 9:18-32)

F I F T E E N O J E W S K K V
P U D I G A C E L E B R A T E
U S F F D N M V J G H I W J S
R F S A O L I M O R D E C A I
I L R E V U U T Y P J I I F U
M Y B S N A R S S S D B U Y N
E H E H U D S T K A U R M T H
E T H S O O A E E O E G F W U
R O T T S L M L G E O F N U Q
C I L N U A I P G A N W O I T
E R W E A P S D P T L T E G K
D O U S D A E T A W L L H H P
T F W E D D J W G Y O G I X L
D Y Q R W Y M B K I U T P V J
L S N P T S G H E S T H E R B

ADAR	FEASTING	HOLIDAY	PRESENTS
CELEBRATE	FIFTEEN	JEWS	PURIM
DECREE	FOURTEENTH	KING	TOWNS
ESTHER	GLADNESS	MORDECAI	VILLAGES

WRITE DOWN THE LETTERS AS YOU COME TO THEM ON THE LINES BELOW

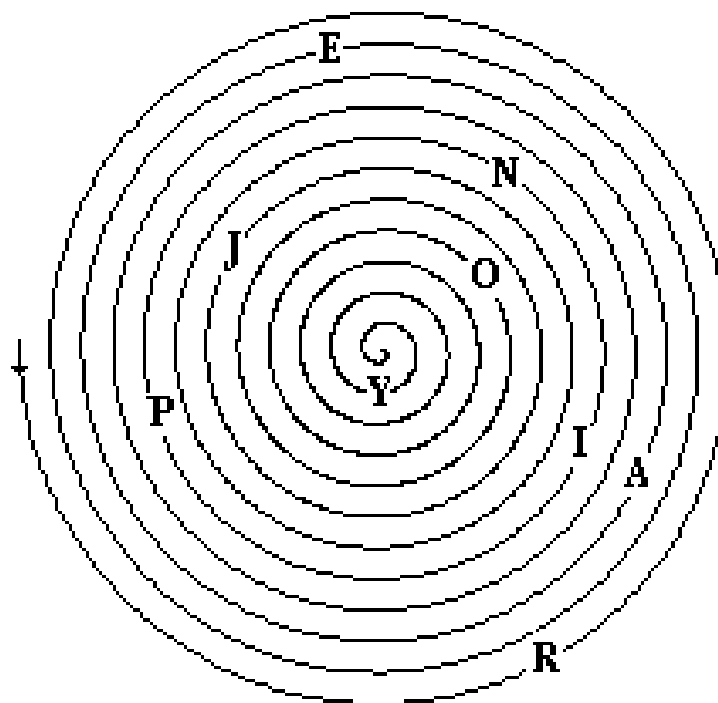

"-----"

134. THE JEWS REJOICE AND DECLARE A FEAST (ESTHER 9:18-32)

MEMORY VERSE:

"Those who sow in tears shall reap in joy." PSALM 126:5

FILL IN THE BLANKS:

1. "The Jews of the villages who dwelt in the unwalled towns _____ the _____ day of the month of Adar as a day of gladness and feasting." **ESTHER 9:19**
2. This was "as a holiday, and for sending _____ to one another." **ESTHER 9:19**

TRUE OR FALSE:

3. "And Mordecai wrote these things and sent letters to all the Jews who were in the provinces of King Ahasuerus, both near and far, to establish among them that they should celebrate yearly the fourteenth and fifteenth days of the month of Adar." **ESTHER 9:20-21**
TRUE OR FALSE

UNDERLINE ONLY THE TRUE STATEMENTS:

4. They should celebrate...**ESTHER 9:22**
 - * as the days on which the Jews had rest from their enemies
 - * as the month which was turned from sorrow to joy for them
 - * and from a holiday to mourning
 - * and from mourning to a holiday
 - * that they should make them days of feasting and joy
 - * of sending presents to one another
 - * and gifts to the rich
 - * and gifts to the poor

FILL IN THE BLANKS:

5. This custom was accepted because "when Esther came before the king, he commanded by letter that this wicked plot which _____ had devised against the Jews should return on his _____ head, and that he and his sons should be hanged on the gallows." **ESTHER 9:25**
6. "The Jews established and imposed it upon themselves and their descendants and all who should join them, that without fail they should _____ these two days every year." **ESTHER 9:27**
7. "So the decree of _____ confirmed these matters of _____, and it was written in the book." **ESTHER 9:32**

134. THE JEWS REJOICE AND DECLARE A FEAST (ESTHER 9:18-32)

A F B A O E W G K A F J B U Q O S Z D K P Y Q N Y
M I A C E D R O M C A H K E E U M W S W E J F H Y
X H B N F A B N B W H Q S C N G C F T U T U G E R
T A R R V W M G U J A O U N V G L M P A O H A D T
Y W B P X L W Z L U H A H Q I G N A N V N A M B E
L R D E C R E E C N Z W P L L F Z I D R I E M Y U
I P K I S Z U J U O Y V E K L K L S T N J C A K S
O E E H T N E E T R U O F D A D U M G S E N O P S
V S F Q V X F P M I N M V D G B T E E O A S K J F
Q G J D M P I N D T J F A O E K M S I U J E S M J
Z D T J A J X U L E T S R K S K O T K V Y A F V S
P E E Q Z H G O S J E W L Q R A E H X Z T I C W G
R P J R S G Y F V T P U W K Y T M E P A H Z Y Z R
E Z Z I H E P L A K L D J L Y W L R P U G S U F A
S C N O I T A R E N E G Y R E V E O U H F N D I S
E C Z L M U B R A D A S U W D L N A Z T P C Y Z F
N Q K S V E Y L R K J J O K J A O T V N Y U G T N
T I C T L W B M C P C H E I I P B M F E Q Z R M T
S W T E S D D S M Z V Q P J P P U Z R E D X T I Q
U Z C F V W R Z L Y T O T S T A L J K T C R I G M
K I N G A H A S U E R U S U V P P S K F M P I G C
A K I A O Y C F N Y W E C E R V M M Y I P J P R D
N K O Y J P G P B W H W S A F Q C X R F O P G H Y
M Q Y A D I L O H O O E C V E D C P G E E Q C U R
G J T Y J Z R G X J P T H D J V V C I F A N J V Q

ADAR
CELEBRATE
DECREE
ESTHER
EVERY GENERATION

FEASTING
FIFTEENTH
FOURTEENTH
GLADNESS

HOLIDAY
JEWS
KING AHASUERUS
MORDECAI

PRESENTS
PURIM
TOWNS
VILLAGES

WRITE DOWN THE LETTERS AS YOU COME TO THEM ON THE LINES BELOW

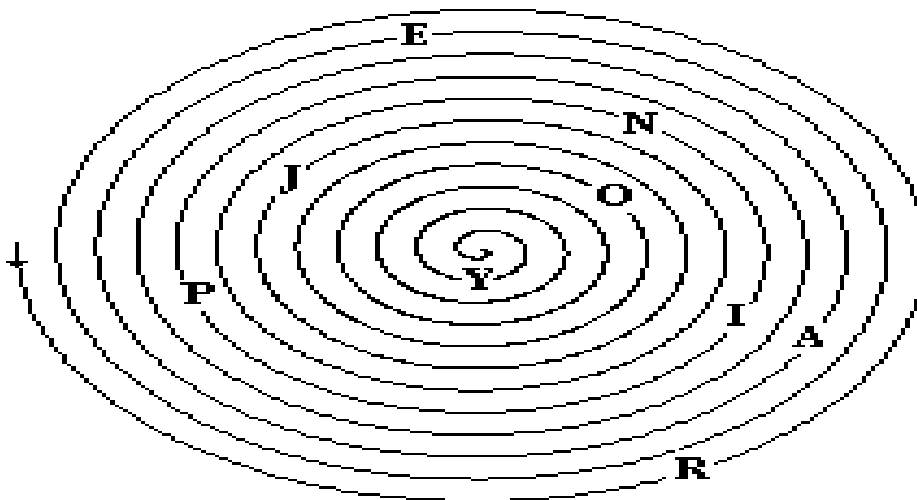

"-----"

134. THE JEWS REJOICE AND DECLARE A FEAST (ESTHER 9:18-32)

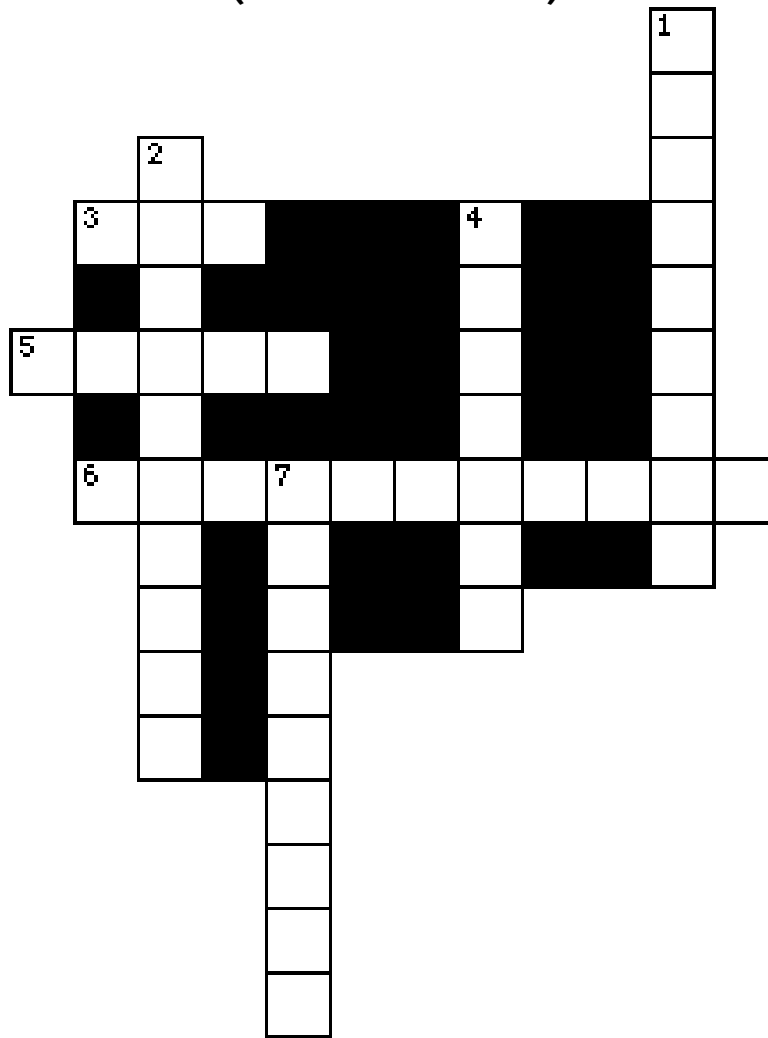

- 3 ACROSS "Those who sow in tears shall reap in _____." **PSALM 126:5**
- 2 DOWN "The Jews of the villages who dwelt in the unwalled towns celebrated the _____ day of the month of Adar as a day of gladness and feasting." **ESTHER 9:19**
- 4 DOWN This was "as a _____, and for sending presents to one another." **ESTHER 9:19**
- 1 DOWN "And Mordecai wrote these things and sent letters to all the Jews who were in the provinces of King Ahasuerus, both near and far, to establish among them that they should _____ yearly the fourteenth and fifteenth days of the month of Adar." **ESTHER 9:20-21**
- 7 DOWN This custom was accepted because "when Esther came before the king, he _____ by letter that this wicked plot which Haman had devised against the Jews should return on his own head, and that he and his sons should be hanged on the gallows." **ESTHER 9:25**
- 6 ACROSS "The Jews established and imposed it upon themselves and their _____ and all who should join them, that without fail they should celebrate these two days every year." **ESTHER 9:27**
- 5 ACROSS "So the decree of Esther confirmed these matters of _____, and it was written in the book." **ESTHER 9:32**

Bible Story 135

**RIGHTEOUS JOB
FEARS GOD**

JOB 1:1-5

135. RIGHTEOUS JOB FEARS GOD

(JOB 1:1-5)



"There was a man in the land of Uz, whose name was Job; and that man was blameless and upright, and one who feared God and shunned evil."

JOB 1:1

135. RIGHTEOUS JOB FEARS GOD

(JOB 1:1-5)

MEMORY VERSE:

"There was a man in the land of Uz, whose name was Job; and that man was blameless and upright, and one who feared God and shunned evil." JOB 1:1

TRUE OR FALSE:

1. "There was a man in the land of Uz, whose name was Job; and that man was blameless and upright, and one who feared God and shunned evil." **JOB 1:1**

TRUE OR FALSE

FILL IN THE BLANKS:

2. "And _____ sons and _____ daughters were born to him." **JOB 1:2**

TRUE OR FALSE:

3. "Also, his possessions were..." **JOB 1:3**

seven thousand sheep

TRUE OR FALSE

three thousand camels

TRUE OR FALSE

five hundred yoke of oxen

TRUE OR FALSE

five hundred female donkeys

TRUE OR FALSE

and a very large backyard

TRUE OR FALSE

CIRCLE THE CORRECT WORD:

4. "Now his sons would go and (**SING, FEAST**) in their houses, each on his appointed day, and would send and invite their three sisters to eat and drink with them." **JOB 1:4**

TRUE OR FALSE:

5. "So it was, when the days of feasting had run their course, that Job would send and sanctify them." **JOB 1:5**

TRUE OR FALSE

CIRCLE THE CORRECT WORDS:

6. Job "would rise early in the morning and offer burnt (**WOOD, OFFERINGS**) according to the numbering of them all." **JOB 1:5**

7. "For Job said, 'It may be that my sons have sinned and cursed God in their (**HEARTS, WORDS**). Thus Job did (**RARELY, REGULARLY**).'" **JOB 1:5**

135. RIGHTEOUS JOB FEARS GOD

(JOB 1:1-5)

B E R F Z V T I F P B T T I Y
 L O E H I Q B O H Z B E I L O
 A O U N V T I V A C R J O Y F
 M H W G V A T H G I R P U F V
 E F S G N I R E F F O Z T I X
 L R J J B Q A Q W C B Z A T S
 E B N G U F M Z Y Q M D N C V
 S Y S R Q Z M U P I E C R N M
 S S N O I S S E S S O P P A A
 J N Z Q Y B O J E W F S I S Z
 F M T S A E F A S Z J T Q S G
 F H K I E H T N G K S R D T O
 D A U G H T E R S K N A J F D
 O L B P L P Y M D Q O E Q A S
 P D Z H N J L G E J S H R Y H

BLAMELESS	HEARTS	SANCTIFY
DAUGHTERS	JOB	SONS
FEAST	OFFERINGS	UPRIGHT
GOD	POSSESSIONS	UZ

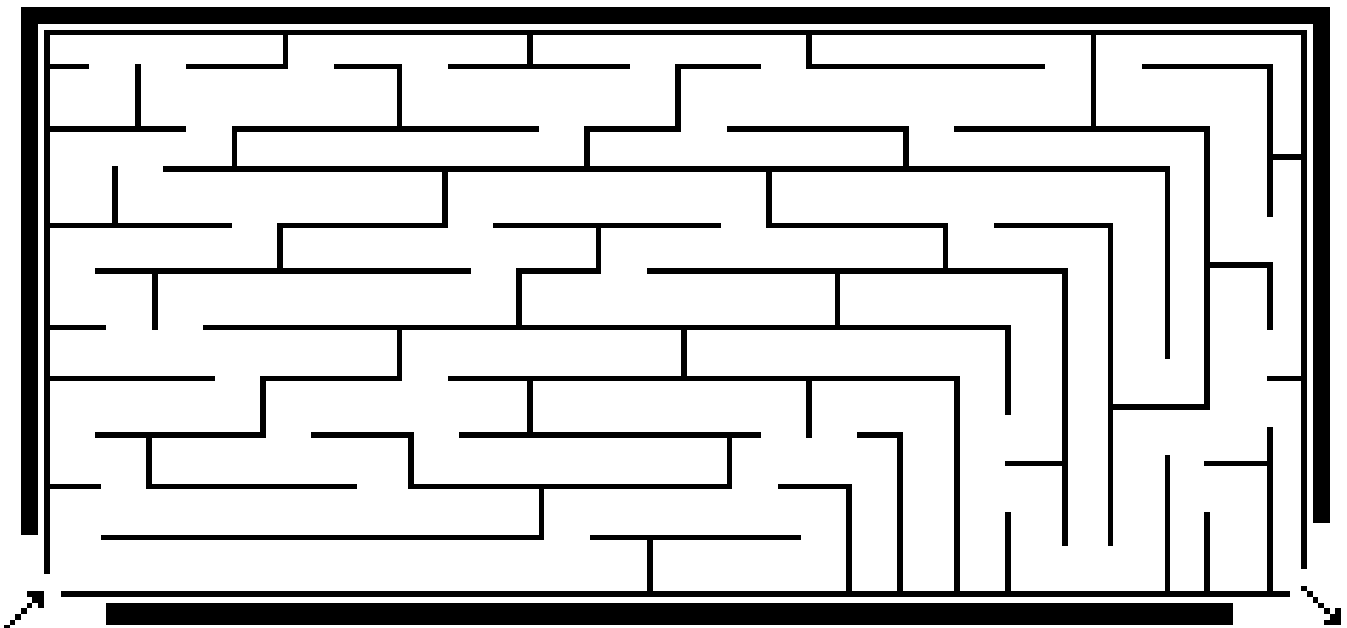

135. RIGHTEOUS JOB FEARS GOD

(JOB 1:1-5)

MEMORY VERSE:

"There was a man in the land of Uz, whose name was Job; and that man was blameless and upright, and one who feared God and shunned evil." JOB 1:1

TRUE OR FALSE:

1. "There was a man in the land of Uz, whose name was Job; and that man was blameless and upright, and one who feared God and shunned evil." **JOB 1:1**

TRUE OR FALSE

FILL IN THE BLANKS:

2. "And _____ sons and _____ daughters were born to him." **JOB 1:2**

MATCHING:

3. "Also, his possessions were..." **JOB 1:3**

_____ seven thousand

_____ three thousand

_____ five hundred yoke of

_____ five hundred female

_____ and a very large

a. **OXEN**

b. **HOUSEHOLD**

c. **DONKEYS**

d. **SHEEP**

e. **CAMELS**

CIRCLE THE CORRECT WORD:

4. "Now his sons would go and (**SING, FEAST**) in their houses, each on his appointed day, and would send and invite their three sisters to eat and drink with them." **JOB 1:4**

TRUE OR FALSE:

5. "So it was, when the days of feasting had run their course, that Job would send and sanctify them." **JOB 1:5**

TRUE OR FALSE

FILL IN THE BLANKS:

6. Job "would rise early in the morning and offer burnt _____ according to the numbering of them all." **JOB 1:5**

7. "For Job said, 'It may be that my sons have sinned and cursed God in their _____. Thus Job did _____.'" **JOB 1:5**

135. RIGHTEOUS JOB FEARS GOD

(JOB 1:1-5)

L Z M L T D B V E E O G S K H B W D N Q
 B F E O L V L U J B O S S R Y W D I F O
 M W W U M N A I O V K A O E G Y I M G V
 I R G P E P E P B T P U E N M U C O I Y
 O Y F W Z Y Z S R E T H G U A D P O E N
 N L Z U I G C N M O Z B Z A M K L F G C
 K N A P I S L S H J L K F I U Y O U W J
 E D N R D N N C Y A S E P P V H P D K N
 Y C S I Z W W O M Q A S E Q E F O I O B
 T V H G P Y C E I S T Y U F Z F D V I L
 E O U H Z Z L N T S V N V R F Q N E L L
 Z S S T V E A P Y L S F F E U W R M D D
 Q H Y C S D Z Y M P G E R C U H O N S N
 V K E S U U O C F V W I S G I M B B U K
 L L J A D G S G B I N L I S M G Q A J A
 S D N P R F D B P G T K U O O Q J S L S
 R F D R W T G C S G U C H W Q P J P J O
 S A Y F E Y S R R Y D Z N J B W C W T N
 B B I M E I P P Y Q K I I A V G O J B S
 B R B E B F P R R D A Q P V S W V H V U

BLAMELESS
 BORN
 DAUGHTERS
 FEAST
 GOD

HEARTS
 JOB
 OFFERINGS
 POSSESSIONS

SANCTIFY
 SONS
 UPRIGHT
 UZ

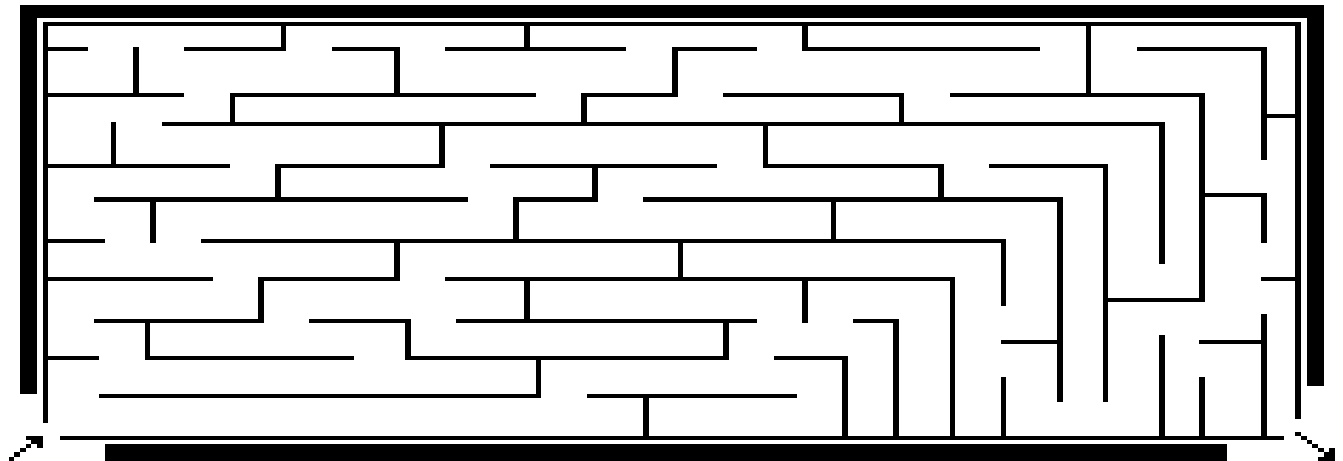

135. RIGHTEOUS JOB FEARS GOD

(JOB 1:1-5)

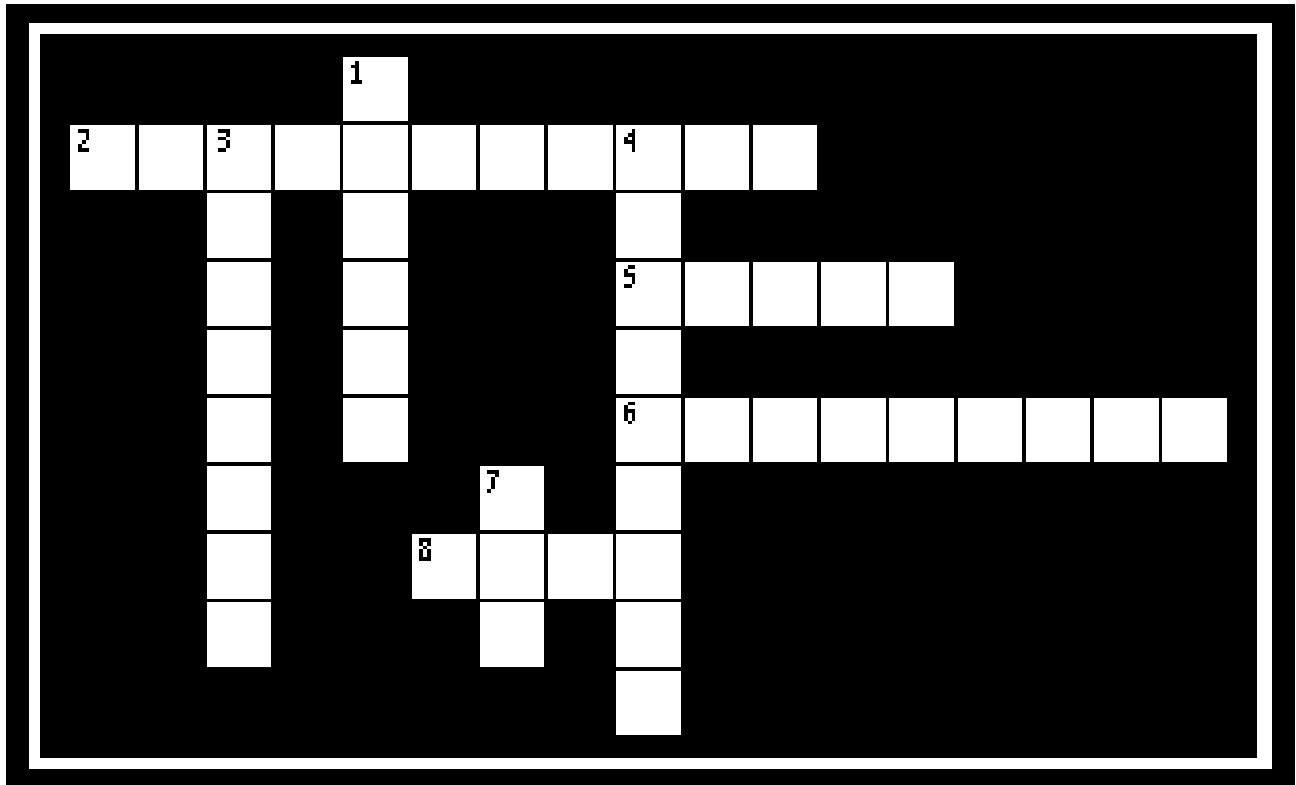

- 7 DOWN "There was a man in the land of Uz, whose name was _____; and that man was blameless and upright, and one who feared God and shunned evil." **JOB 1:1**
- 8 ACROSS "And seven sons and three daughters were _____ to him." **JOB 1:2**
- 2 ACROSS "Also, his _____ were seven thousand sheep, three thousand camels, five hundred yoke of oxen, five hundred female donkeys, and a very large household." **JOB 1:3**
- 5 ACROSS "Now his sons would go and _____ in their houses, each on his appointed day, and would send and invite their three sisters to eat and drink with them." **JOB 1:4**
- 3 DOWN "So it was, when the days of feasting had run their course, that Job would send and _____ them." **JOB 1:5**
- 4 DOWN Job "would rise early in the morning and offer burnt _____ according to the numbering of them all." **JOB 1:5**
- 1 DOWN "For Job said, 'It may be that my sons have sinned and cursed God in their _____.'" **JOB 1:5**
- 6 ACROSS "Thus Job did _____." **JOB 1:5**

Bible Story 136

JOB'S FIRST TEST

JOB 1:6-22

136. JOB'S FIRST TEST

(JOB 1:6-22)



"While he was yet speaking, there came also another, and said, The Chaldeans made out three bands, and fell upon the camels, and have carried them away, yea, and slain the servants with the edge of the sword; and I only am escaped alone to tell thee."

JOB 1:17

136. JOB'S FIRST TEST

(JOB 1:6-22)

MEMORY VERSE:

"In all this Job did not sin nor charge God with wrong." JOB 1:22

"Now there was a day when the sons of God came to present themselves before the LORD, and Satan also came among them." JOB 1:6

FILL IN THE BLANKS:

1. "The LORD said to Satan, 'Have you considered _____, that there is none like him on the earth, a blameless and upright man, one who fears God and shuns evil?' " **JOB 1:8**

CIRCLE THE CORRECT WORDS:

THE SAME WORD IS USED THREE TIMES IN THIS VERSE. CIRCLE THAT WORD.

2. "So Satan answered the LORD and said, 'Does Job fear God for nothing? Have You not made a hedge _____ him, _____ his household, and _____ all that he has on every side?' " **JOB 1:9-10**
UNDER OVER AROUND
3. Also Satan said, "You have blessed the work of his hands, and his possessions have increased in the land. But now stretch out Your hand and touch all that he has, and he will surely (**CURSE, BLESS**) You to Your face!" **JOB 1:10-11**
4. "So the LORD said to Satan, 'Behold, all that he has is in your (**POCKET, POWER**); only do not lay a hand on his person.' Then Satan went out from the presence of the LORD." **JOB 1:12**

TRUE OR FALSE:

"A messenger came to Job and said..."

5. "The oxen were plowing and the donkeys feeding beside them, when the Sabeans raided them and took them away- indeed they have killed the servants with the edge of the sword; and I alone have escaped to tell you!" **JOB 1:14-15**

TRUE OR FALSE

CIRCLE THE CORRECT WORDS:

"While he was still speaking, another also came and said..."

6. "The (**FIRE, RAIN**) of God fell from heaven and burned up the sheep and the servants, and consumed them; and I alone have escaped to tell you!" **JOB 1:16**

"While he was still speaking, another also came and said..."

7. "The (**BALDEANS, CHALDEANS**) formed three bands, raided the camels and took them away, yes, and killed the servants with the edge of the sword; and I alone have escaped to tell you!" **JOB 1:17**

"While he was still speaking, another also came and said..."

8. "Your sons and daughters were eating and drinking wine in their oldest brother's house, and suddenly a great (**WIND, CLOUD**) came from across the wilderness and struck the four corners of the house, and it fell on the young men, and they are dead; and I alone have escaped to tell you!" **JOB 1:18-19**

TRUE OR FALSE:

9. Then Job arose and tore his robe and shaved his head, and he fell to the ground and gave up. **JOB 1:20**

TRUE OR FALSE

10. "In all this Job did not sin nor charge God with wrong." **JOB 1:22**

TRUE OR FALSE

136. JOB'S FIRST TEST

(JOB 1:6-22)

MEMORY VERSE:

"In all this Job did not sin nor charge God with wrong." JOB 1:22

"Now there was a day when the sons of God came to present themselves before the LORD, and Satan also came among them." JOB 1:6

FILL IN THE BLANKS:

1. "The LORD said to Satan, 'Have you considered _____, that there is none like him on the earth, a blameless and upright man, one who fears God and shuns evil?' " **JOB 1:8**

CIRCLE THE CORRECT WORDS:

THE SAME WORD IS USED THREE TIMES IN THIS VERSE. CIRCLE THAT WORD.

2. "So Satan answered the LORD and said, 'Does Job fear God for nothing? Have You not made a hedge _____ him, _____ his household, and _____ all that he has on every side?' " **JOB 1:9-10**
UNDER OVER AROUND

FILL IN THE BLANKS:

3. Also Satan said, "You have blessed the work of his hands, and his possessions have increased in the land. But now stretch out Your hand and touch all that he has, and he will surely _____ You to Your face!" **JOB 1:10-11**
4. "So the LORD said to Satan, 'Behold, all that he has is in your _____; only do not lay a hand on his person.' Then Satan went out from the presence of the LORD." **JOB 1:12**

TRUE OR FALSE:

"A messenger came to Job and said..."

5. "The oxen were plowing and the donkeys feeding beside them, when the Sabeans raided them and took them away- indeed they have killed the servants with the edge of the sword; and I alone have escaped to tell you!" **JOB 1:14-15**

TRUE OR FALSE

FILL IN THE BLANKS:

"While he was still speaking, another also came and said..."

6. "The _____ of God fell from heaven and burned up the sheep and the servants, and consumed them; and I alone have escaped to tell you!" **JOB 1:16**

"While he was still speaking, another also came and said..."

7. "The Chaldeans formed three bands, raided the _____ and took them away, yes, and killed the _____ with the edge of the sword; and I alone have escaped to tell you!" **JOB 1:17**

"While he was still speaking, another also came and said..."

8. "Your sons and daughters were eating and drinking wine in their oldest brother's house, and suddenly a great _____ came from across the wilderness and struck the four corners of the house, and it fell on the young men, and they are dead; and I alone have escaped to tell you!" **JOB 1:18-19**

9. "Then Job arose and tore his robe and shaved his head, and he fell to the ground and _____." **JOB 1:20**

TRUE OR FALSE:

10. "In all this Job did not sin nor charge God with wrong." **JOB 1:22**

TRUE OR FALSE

136. JOB'S FIRST TEST

(JOB 1:6-22)

C C B K O R R T O D E Q X W Y D L S I Z
 W E R I F E Q A V E F D S L P R W I N D
 G N M T P U I Q Q P J J N Z Z C M V T Y
 D Q H D E W P F Z Z T O V O W G S R E N
 T D E Y O J H H M C E B M P S R Z C J J
 H C D E S S E L B C J J A P B R F M K T
 A E R H O N Z P A Q Z Q Z J M G E L K P
 S N D B C S I J N I Z R S H W N P P P L
 T W J G F Z V T M W K I H D E V A H S J
 O T S Q E K V B G Z C L M G U G G B Z C
 T I T S K B B I F Z C H Y E F Z K W Y V
 W D E P I H S R O W T S A U I J B A Y T
 F W A S B Z Q A H K I T S L P P U C O W
 A P Z I Y F Y M A Q O F V W D N K W J H
 M P S L N H E B W J T A O D G E C J F P
 F W D S M N L T S B A Y D E D I A R A J
 S E R V A N T S P B N Y J W Y U U N H H
 H Q J J H G N Y E R R O J G P O M U S Q
 K T Q F L N V L S B P F E O Y F D K A O
 N A I F D G Q I G K I V A D B L L O H A

BLESSED
 CHALDEANS
 FIRE
 GOD

HEDGE
 JOB
 PERSON
 RAIDED

SERVANTS
 SHAVED
 WIND
 WORSHIPED

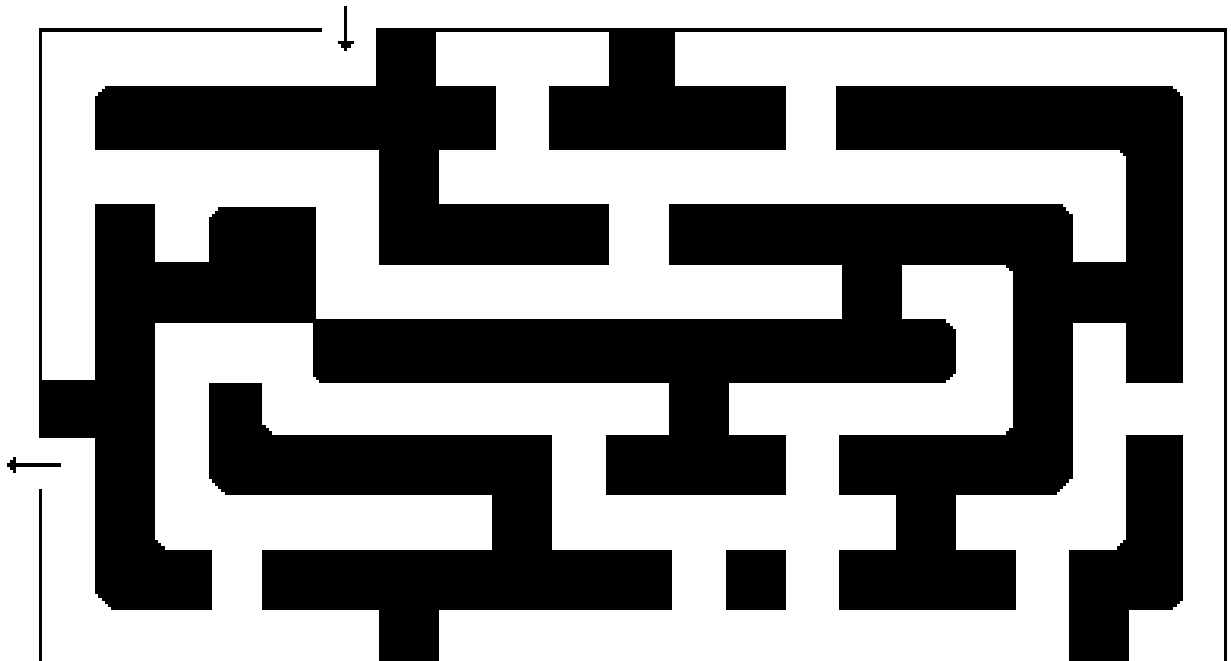

136. JOB'S FIRST TEST

(JOB 1:6-22)

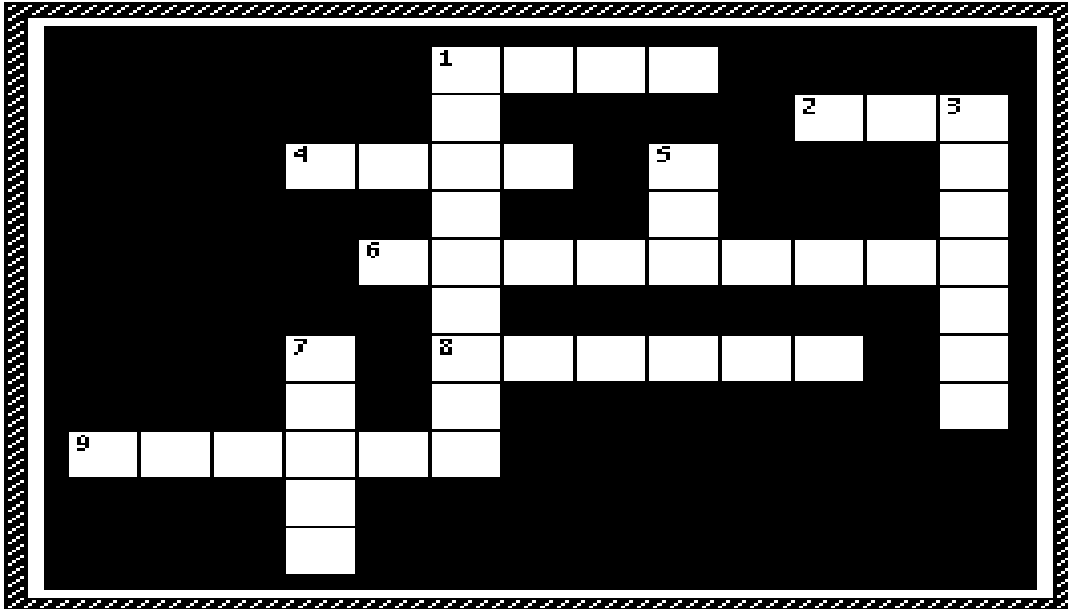

- 2 ACROSS "The LORD said to Satan, 'Have you considered My servant _____, that there is none like him on the earth, a blameless and upright man, one who fears God and shuns evil?' " **JOB 1:8**
- 7 DOWN "So Satan answered the LORD and said, 'Does Job fear God for nothing? Have You not made a _____ around him, around his household, and around all that he has on every side?' " **JOB 1:9-10**
- 3 DOWN Also Satan said, "You have _____ the work of his hands, and his possessions have increased in the land." **JOB 1:10**
- 8 ACROSS "So the LORD said to Satan, 'Behold, all that he has is in your power; only do not lay a hand on his _____.' Then Satan went out from the presence of the LORD." **JOB 1:12**
- 9 ACROSS "The oxen were plowing and the donkeys feeding beside them, when the Sabeans _____ them and took them away." **JOB 1:14-15**
- 4 ACROSS "The _____ of God fell from heaven and burned up the sheep and the servants, and consumed them; and I alone have escaped to tell you!" **JOB 1:16**
- 6 ACROSS "The _____ formed three bands, raided the camels and took them away, yes, and killed the servants with the edge of the sword; and I alone have escaped to tell you!" **JOB 1:17**
- 1 ACROSS "Your sons and daughters were eating and drinking wine in their oldest brother's house, and suddenly a great _____ came from across the wilderness and struck the four corners of the house, and it fell on the young men, and they are dead; and I alone have escaped to tell you!" **JOB 1:18-19**
- 1 DOWN "Then Job arose and tore his robe and shaved his head, and he fell to the ground and _____." **JOB 1:20**
- 5 DOWN "In all this Job did not sin nor charge _____ with wrong." **JOB 1:22**

Bible Story 137

JOB'S SECOND TEST

JOB 2:1-10

137. JOB'S SECOND TEST

(JOB 2:1-10)



"Then said his wife unto him, Dost thou still retain thine integrity? curse God, and die. But he said unto her, Thou speakest as one of the foolish women speaketh. What? shall we receive good at the hand of God, and shall we not receive evil? In all this did not Job sin with his lips."

JOB 2:9-10

137. JOB'S SECOND TEST

(JOB 2:1-10)

MEMORY VERSE:

"Shall we indeed accept good from God, and shall we not accept adversity?" JOB 2:10

"Again there was a day when the sons of God came to present themselves before the LORD, and Satan came also among them to present himself before the LORD." JOB 2:1

TRUE OR FALSE:

1. "The LORD said to Satan, 'Have you considered My servant Job, that there is none like him on the earth, a blameless and upright man, one who fears God and shuns evil?' " **JOB 2:3**
TRUE OR FALSE

CIRCLE THE CORRECT WORDS:

2. Also the LORD said concerning Job, "... he holds fast to his integrity, although you incited Me against him, to destroy him (**WITH, WITHOUT**) cause." **JOB 2:3**
3. "So Satan answered the LORD and said, 'Skin for skin! Yes, all that a man has he will give for his (**LIFE, KNIFE**).' " **JOB 2:4**

FILL IN THE BLANKS:

4. "But stretch out Your hand now, and touch his _____ and his _____, and he will surely curse You to Your face!" **JOB 2:5**

TRUE OR FALSE:

5. So the LORD said to Satan, "Behold, he is in your hand, and take his life also." **JOB 2:6**
TRUE OR FALSE

CIRCLE THE CORRECT WORDS:

6. "Then Satan went out from the presence of the LORD, and struck Job with painful (**SOILS, BOILS**) from the sole of his foot to the crown of his head." **JOB 2:7**
7. "And he took for himself a potsherd with which to (**TAPE, SCRAPE**) himself while he sat in the midst of the ashes." **JOB 2:8**

TRUE OR FALSE:

8. "Then his wife said to him, 'Do you still hold to your integrity? Curse God and die!' " **JOB 2:9**
TRUE OR FALSE
9. "In all this Job did not sin with his lips." **JOB 2:10**
TRUE OR FALSE

137. JOB'S SECOND TEST

(JOB 2:1-10)

I H S E L F Q P I H E K B T R
K S E M S G Y J O B P Q K I I
T I O H Z R E T V S O J E O L
D L O L K Q L B E A E I F T S
Y S T H G I R P U N Z H L A T
H J S D B I N I Q W O B S S F
S F C I Z P V A Z X C B J A A
K F F R N H Q M U P C B T N Y
I Y T I R G E T N I Q E S R Y
N O K E F Z T X A E I P E P O
U P B U H I A T N S I A J I F
B L Y W N V Q Y M L E R Z Q V
P O T S H E R D G F W C Z D X
Q R J J G V F L I G Z S K J S
S D N N X B H L F D K R C Q V

ASHES

JOB

SCRAPE

BOILS

LIFE

SIN

BONE

LIPS

SKIN

FLESH

LORD

UPRIGHT

INTEGRITY

POTSHERD

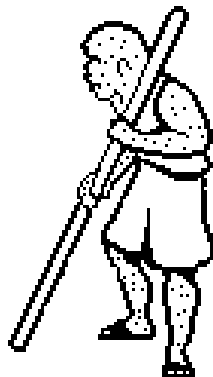

137. JOB'S SECOND TEST

(JOB 2:1-10)

MEMORY VERSE:

"Shall we indeed accept good from God, and shall we not accept adversity?" JOB 2:10

"Again there was a day when the sons of God came to present themselves before the LORD, and Satan came also among them to present himself before the LORD." JOB 2:1

TRUE OR FALSE:

1. "The LORD said to Satan, 'Have you considered My servant Job, that there is none like him on the earth, a blameless and upright man, one who fears God and shuns evil?' " **JOB 2:3**
TRUE OR FALSE

FILL IN THE BLANKS:

2. Also the LORD said concerning Job, "... he holds fast to his integrity, although you incited Me against him, to destroy him _____ cause." **JOB 2:3**
3. "So Satan answered the LORD and said, 'Skin for skin! Yes, all that a man has he will give for his _____.'" **JOB 2:4**
4. "But stretch out Your hand now, and touch his _____ and his _____, and he will surely curse You to Your face!" **JOB 2:5**

TRUE OR FALSE:

5. So the LORD said to Satan, "Behold, he is in your hand, and take his life also." **JOB 2:6**
TRUE OR FALSE

FILL IN THE BLANKS:

6. "Then Satan went out from the presence of the LORD, and struck Job with painful _____ from the sole of his foot to the crown of his head." **JOB 2:7**
7. "And he took for himself a potsherd with which to _____ himself while he sat in the midst of the ashes." **JOB 2:8**
8. "Then his wife said to him, 'Do you still hold to your _____? Curse God and die!' "
JOB 2:9

TRUE OR FALSE:

9. "In all this Job did not sin with his lips." **JOB 2:10**
TRUE OR FALSE

137. JOB'S SECOND TEST

(JOB 2:1-10)

U K B J A T A Q E C G G M F N S T I V M H N V R M
 Y T O X L N L H N D W C A L I E W B S J L D F S L
 Y G H W O A B A H W A Z S Y S J I R U Q A K H K M
 R E S B Z A Z U L S F S C R A P E W G L U N N B S
 F Y O E M S D I Q K E H V H V M H G H J V U E I G
 H J S L F L P V N I U L Y X U G J T U T A Y E F E
 E G R V M S Z U E E T K F O U O D K S L I O B W Y
 L M V D Q P N T N R O K K I A V U W Q W E E M L U
 M Q N D S L K T A P S R W R D S W I T K I E J J W
 G H G Z Q T O D Y I M I L F D P O U P T S J Q B I
 M V D Z V N B D Q Y D E T Y W T T M L H G A V B A
 B V P O P D H Q U B J R W Y T W S F J G J V E K C
 P G K W B R F C Q B K N O X L B H O B I P K S I N
 M S S H Q A V U T P G C W L A H E E J R Z U V J L
 W N S K J Z I I H P H V Z D O J R P H P F O V K P
 N B P Q I E O J N Y G C O F A Y D K T U B Z L U A
 G K P I I N N K T T D C A B P K O J J M X X A M I
 K K R L C M H S T F E H K E A P E F Y L K A I X E
 B O X H T D I M R O V G U H D G N Y R U M M L Y Y
 Y J O T C W U J R J B R R T Y K O T D G Z Z R R A
 K Q S Y J Q A T W W A E N I S G B W C C X B U T Q
 P S L O W X F E P S S M U L T P L U G V I T U T A
 U P K A Y I F A N S H Q D U M Y O G S U Z P C C O
 Y M W V J I F A K I E N L W U S U H Q B F Z Q M Y
 F B V C L T T S B A S Y U Q R O I V U N Z F N P E

ADVERSITY	INTEGRITY	POTSHERD
ASHES	JOB	SCRAPE
BOILS	LIFE	SIN
BONE	LIPS	SKIN
FLESH	LORD	UPRIGHT

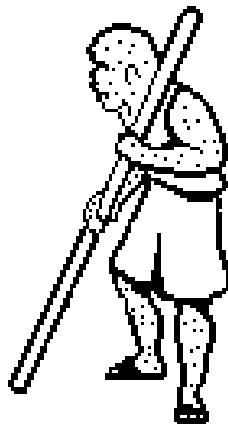

137. JOB'S SECOND TEST

(JOB 2:1-10)

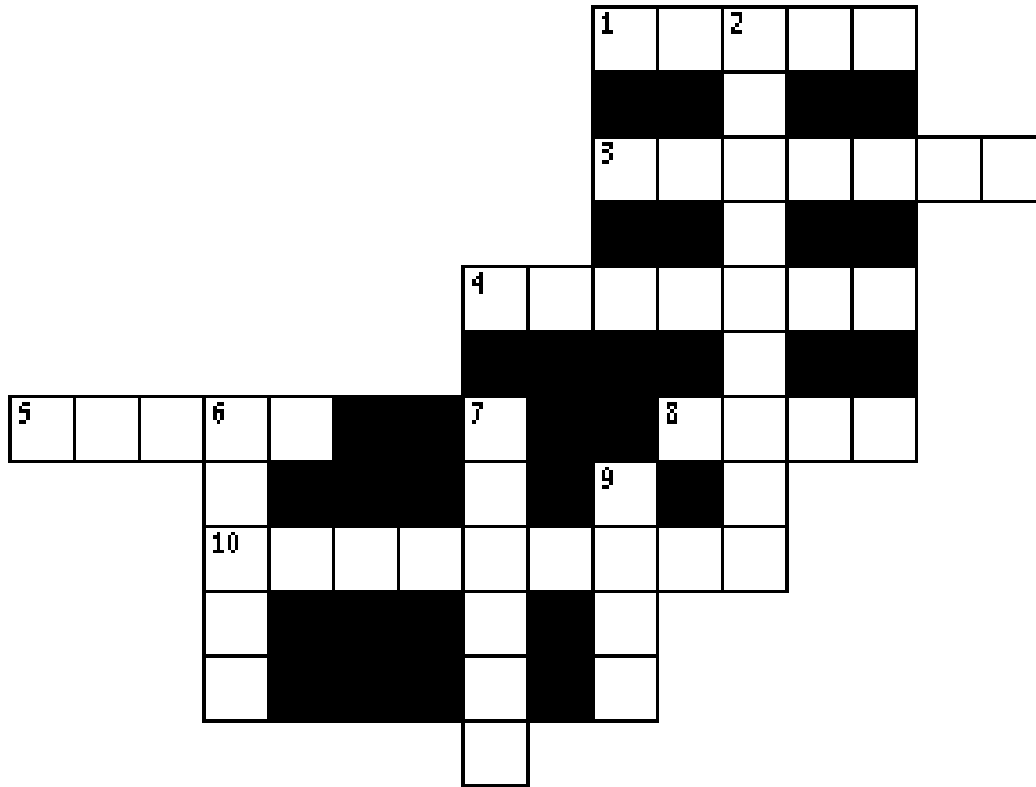

- 4 ACROSS "The LORD said to Satan, 'Have you considered My servant Job, that there is none like him on the earth, a blameless and _____ man, one who fears God and shuns evil?' " **JOB 2:3**
- 3 ACROSS Also the LORD said concerning Job, "... he holds fast to his integrity, although you incited Me against him, to destroy him _____ cause." **JOB 2:3**
- 8 ACROSS "So Satan answered the LORD and said, 'Skin for skin! Yes, all that a man has he will give for his _____.'" **JOB 2:4**
- 5 ACROSS "But stretch out Your hand now, and touch his bone and his _____, and he will surely curse You to Your face!" **JOB 2:5**
- 6 DOWN "So the LORD said to Satan, 'Behold, he is in your hand, but _____ his life.'" **JOB 2:6**
- 1 ACROSS "Then Satan went out from the presence of the LORD, and struck Job with painful _____ from the sole of his foot to the crown of his head." **JOB 2:7**
- 7 DOWN "And he took for himself a potsherd with which to _____ himself while he sat in the midst of the ashes." **JOB 2:8**
- 2 DOWN "Then his wife said to him, 'Do you still hold to your _____? Curse God and die!' " **JOB 2:9**
- 10 ACROSS "Shall we indeed accept good from God, and shall we not accept _____?" **JOB 2:10**
- 9 DOWN "In all this Job did not sin with his _____." **JOB 2:10**

Bible Story 138

**JOB &
HIS THREE FRIENDS**

JOB 2:11-32:1

138. JOB AND HIS THREE FRIENDS

(JOB 2:11-32:1)



"Now when Job's three friends heard of all this evil that was come upon him, they came every one from his own place; Eliphaz the Temanite, and Bildad the Shuhite, and Zophar the Naamathite: for they had made an appointment together to come to mourn with him and to comfort him."

JOB 2:11

138. JOB AND HIS THREE FRIENDS

(JOB 2:11-32:1)

MEMORY VERSE:

"For I know that my Redeemer lives, and He shall stand at last on the earth." JOB 19:25

TRUE OR FALSE:

1. "Now when Job's three friends heard all this adversity that had come upon him, each one came from his own place." JOB 2:11

TRUE OR FALSE

2. "They made an appointment together to come and mourn with him, and to comfort him." JOB 2:11

TRUE OR FALSE

3. When they raised their eyes from afar, they recognized him, and raised their voices in song. JOB 2:12

TRUE OR FALSE

CIRCLE THE CORRECT WORDS:

4. "Each one (**CLEANED, TORE**) his robe and sprinkled (**DUST, FOOD**) on his head toward heaven." JOB 2:12

5. "So they sat down with him on the ground seven days and seven nights, and no one spoke a word to him, for they saw that his grief was very (**SMALL, GREAT**)." JOB 2:13

6. "After this Job opened his mouth and (**CURSED, BLESSED**) the day of his birth." JOB 3:1

TRUE OR FALSE:

7. Eliphaz charged Job, saying, "Remember now, who ever perished being innocent? Or where were the upright ever cut off? Even as I have seen, those who plow iniquity and sow trouble reap the same." JOB 4:7-8

TRUE OR FALSE

FILL IN THE BLANKS:

8. Bildad believed that Job needed to repent and charged him, saying, "_____ would earnestly seek God and make your supplication to the Almighty, _____ were pure and upright, surely now He would awake for you, and prosper your rightful habitation." JOB 8:5-6

9. Job asked "How can a man be _____ before God?" JOB 9:2

CIRCLE THE CORRECT WORDS:

10. Zophar charged Job, saying, "If iniquity were in your hand, and you put it far away, and would not let wickedness dwell in your tents; then surely you could lift up your face (**WITH, WITHOUT**) spot." JOB 11:14-15

11. Job answered and said, "I am one (**SHOCKED, MOCKED**) by his friends, who called on God, and He answered him, the just and blameless who is laughed to scorn." JOB 12:4

TRUE OR FALSE:

12. "So these three men ceased answering Job, because he was righteous in his own eyes." JOB 32:1

TRUE OR FALSE

138. JOB AND HIS THREE FRIENDS

(JOB 2:11-32:1)

R T R O F M O C D N G B C J Y
P I V M A H Y U R U O M M K N
I L X F E I R G W J K D L K J
Q M O C K E D F C E B L B P T
D S T N E C O N N I P S L Z P
J T S M W G P I G O B T A Y L
Z F V S L E Z X R F I V C Y E
O A M V Z U W G G L L R W O B
P S U O E T H G I R D Z J J O
H Y A O N R U O M L A A U F R
A Y Z J X W B Y N M D H K A J
R O S J P D M P G S U P O H C
R E D E E M E R Z Z G I I A V
Q F H E J W W Y J F S L T H T
R D E N N I S B P P M E E Z W

BILDAD

JOB

ROBE

COMFORT

MOCKED

SINNED

ELIPHAZ

MOURN

WEPT

GRIEF

REDEEMER

ZOPHAR

INNOCENT

RIGHTEOUS



138. JOB AND HIS THREE FRIENDS

(JOB 2:11-32:1)

MEMORY VERSE:

"For I know that my Redeemer lives, and He shall stand at last on the earth." JOB 19:25

FILL IN THE BLANK:

1. "Now when Job's three friends heard all this _____ that had come upon him, each one came from his own place." JOB 2:11

TRUE OR FALSE:

2. "They made an appointment together to come and mourn with him, and to comfort him." JOB 2:11
TRUE OR FALSE
3. When they raised their eyes from afar, they recognized him, and raised their voices in song. JOB 2:12
TRUE OR FALSE

FILL IN THE BLANKS:

4. "Each one _____ his robe and sprinkled _____ on his head toward heaven." JOB 2:12
5. "So they sat down with him on the ground seven _____ and seven _____, and no one spoke a word to him, for they saw that his grief was very great." JOB 2:13
6. "After this Job opened his mouth and _____ the day of his birth." JOB 3:1

TRUE OR FALSE:

7. Eliphaz charged Job, saying, "Remember now, who ever perished being innocent? Or where were the upright ever cut off? Even as I have seen, those who plow iniquity and sow trouble reap the same." JOB 4:7-8
TRUE OR FALSE

FILL IN THE BLANKS:

8. Bildad believed that Job needed to repent and charged him, saying, "____ _____ would earnestly seek God and make your supplication to the Almighty, _____ were pure and upright, surely now He would awake for you, and prosper your rightful habitation." JOB 8:5-6
9. Job asked "How can a man be _____ before God?" JOB 9:2
10. Zophar charged Job, saying, "If _____ were in your hand, and you put it far away, and would not let wickedness dwell in your tents; then surely you could lift up your face without spot." JOB 11:14-15
11. Job answered and said, "I am one _____ by his friends, who called on God, and He answered him, the just and blameless who is laughed to scorn." JOB 12:4

TRUE OR FALSE:

12. "So these three men ceased answering Job, because he was righteous in his own eyes." JOB 32:1
TRUE OR FALSE

138. JOB AND HIS THREE FRIENDS

(JOB 2:11-32:1)

C A K M D K Y T V N S T Q E E B C U A N
P S F G H F H A D M S P H T J K R A I A
N V S A N E D Z I R A W G V O D B U Q E
S V Z B I L D A D W W T M G Z O D G A H
S D E N N I S T A Q P N F F S Z P R F T
C M V G S D C A R E F Y F B D S H B Z O
E F U D K S O E W N S U A L F M T K I M
T H W I Y A M F E I R G M P K O N Q V G
H Q M B J E F R L W L F H Y T C E I B R
C T N E E G O H I E I I T A S K C A C M
P E Z D E T R L P Q T B Z Z H E O P T M
A W E V Z W T L H W M N H Y A D N W F H
J R I Z T J E I A A K R F G Y E N H M K
H I C K H R E K Z N Y U E K V T I Y N G
R N J O T G E S T G M O A V E H Z Q D R
E D J W M T M K J T W M J J G O T J P Y
B N D C E R W L M E M Q D B P Q A M S D
O G Q O G N O S S U O E T H G I R B J R
R B Q C B D V R L J H F A U O R Y O X J
M N K E J A G Q T T B R M U B M U J L A

BILDAD

INNOCENT

RIGHTEOUS

COMFORT

JOB

ROBE

ZOPHAR

MOCKED

SINNED

ELIPHAZ

MOURN

WEPT

GRIEF

REDEEMER

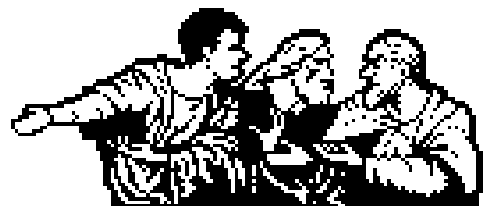

138. JOB AND HIS THREE FRIENDS

(JOB 2:11-32:1)

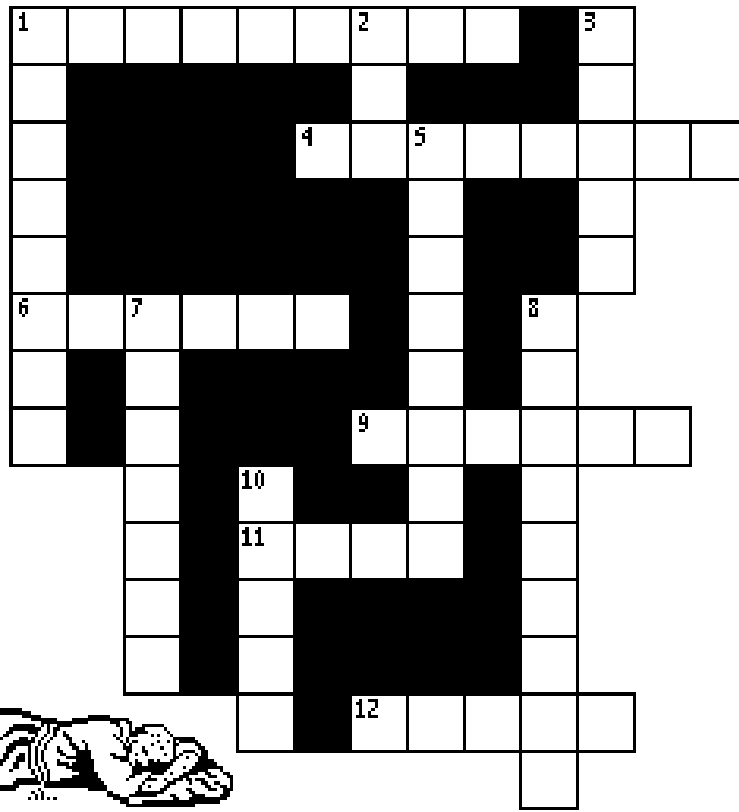

- 8 DOWN "Now when Job's three friends heard all this _____ that had come upon him, each one came from his own place." **JOB 2:11**
- 7 DOWN "They made an appointment together to come and mourn with him, and to _____ him." **JOB 2:11**
- 11 ACROSS "When they raised their eyes from afar, and did not recognize him, they lifted their voices and _____." **JOB 2:12**
- 9 ACROSS "Each one tore his robe and sprinkled dust on his head toward _____." **JOB 2:12**
- 3 DOWN "So they sat down with him on the ground seven days and seven nights, and no one spoke a word to him, for they saw that his _____ was very great." **JOB 2:13**
- 12 ACROSS "After this Job opened his mouth and cursed the day of his _____." **JOB 3:1**
- 5 DOWN Eliphaz charged Job, saying, "Remember now, who ever perished being _____?" **JOB 4:7**
- 10 DOWN Bildad believed that Job needed to repent and charged him, saying, "If you would earnestly seek God and make your supplication to the Almighty, if you were pure and upright, surely now He would _____ for you, and prosper your rightful habitation." **JOB 8:5-6**
- 1 ACROSS Job asked "How can a man be _____ before God?" **JOB 9:2**
- 4 ACROSS Zophar charged Job, saying, "If _____ were in your hand, and you put it far away, and would not let wickedness dwell in your tents; then surely you could lift up your face with spot." **JOB 11:14-15**
- 6 ACROSS Job answered and said, "I am one _____ by his friends, who called on God, and He answered him, the just and blameless who is laughed to scorn." **JOB 12:4**
- 1 DOWN "For I know that my _____ lives, and He shall stand at last on the earth." **JOB 19:25**
- 2 DOWN "So these three men ceased answering Job, because he was righteous in his _____ eyes." **JOB 32:1**

Bible Story 139

**ELIHU
CONTRADICTS
JOB'S FRIENDS**

JOB 32:1-37:24

139. ELIHU CONTRADICTS JOB'S FRIENDS

(JOB 32:1-37:24)

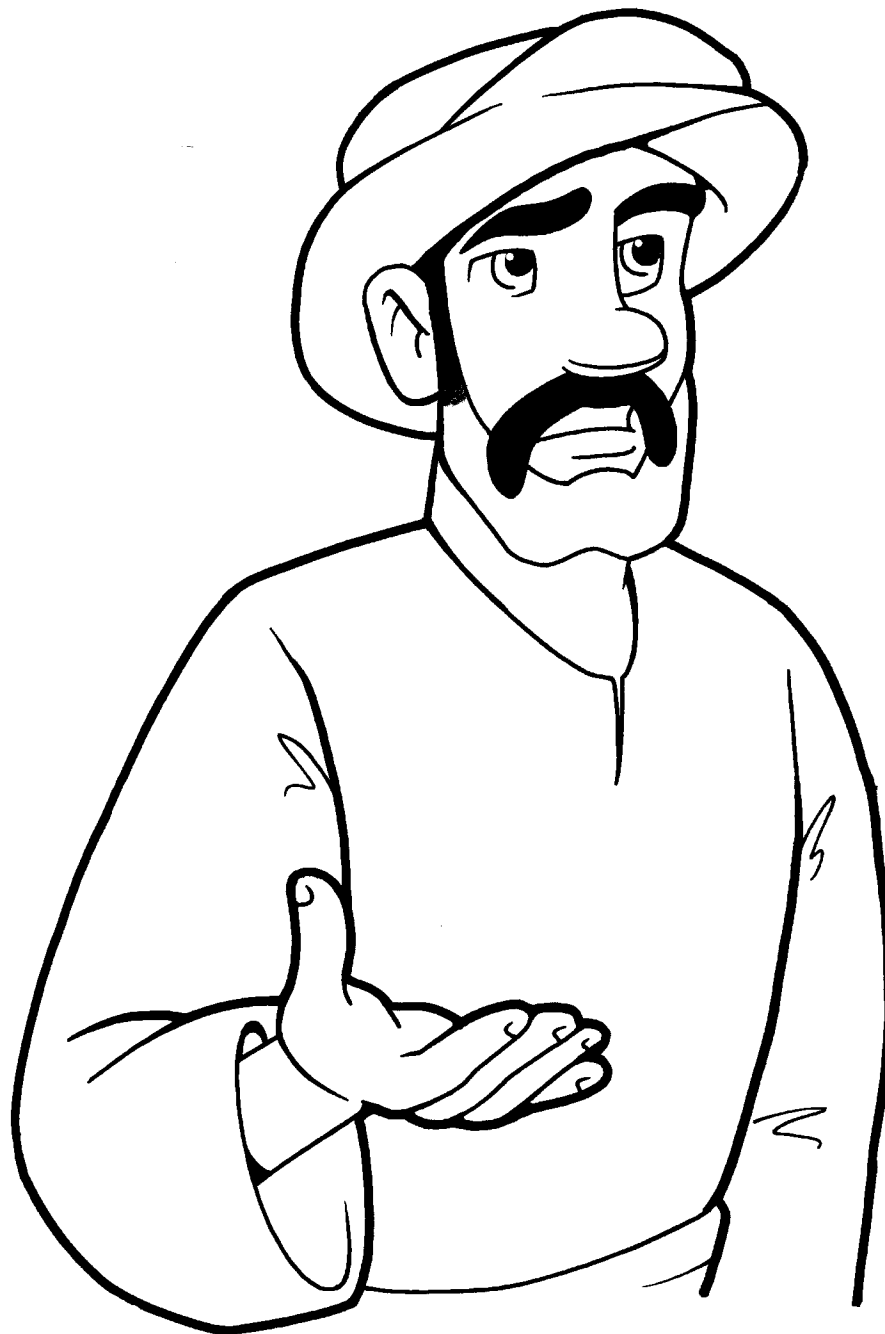

"Behold, my belly *is* as wine *which* hath no vent; it is ready to burst like new bottles. I will speak, that I may be refreshed: I will open my lips and answer."

JOB 32:19-20

139. ELIHU CONTRADICTS JOB'S FRIENDS

(JOB 32:1-37:24)

MEMORY VERSE:

"Surely God will never do wickedly, nor will the Almighty pervert justice." JOB 34:12

FILL IN THE BLANKS:

1. "The wrath of Elihu, the son of Barachel the Buzite, of the family of Ram, was aroused against Job; his wrath was aroused because he justified _____ rather than _____."
JOB 32:2

CIRCLE THE CORRECT WORDS:

2. "Also against his three friends his wrath was aroused, because they had found **(ONE, NO)** answer, and yet had condemned Job." **JOB 32:3**
3. "Now because they were years **(OLDER, YOUNGER)** than he, Elihu had waited to speak to Job." **JOB 32:4**
4. Elihu said to Job, "If there is a messenger for him, a **(MEDIATOR, MEDLER)**, one among a thousand, to show man His uprightness, then He is gracious to him and says, 'Deliver him from going down to the Pit.' " **JOB 33:23-24**

TRUE OR FALSE:

5. Then Elihu also charged Job, saying, "Men of understanding say to me, wise men who listen to me: 'Job speaks without knowledge, his words are without wisdom.' " **JOB 34:34-35**
TRUE OR FALSE
6. "Surely God will not listen to empty talk, nor will the Almighty regard it." **JOB 35:13**
TRUE OR FALSE

CIRCLE THE CORRECT WORD:

7. Finally Elihu said to Job, "Listen to this O Job; stand still and consider the wondrous works of **(GOD, MAN)**." **JOB 37:14**

139. ELIHU CONTRADICTS JOB'S FRIENDS (JOB 32:1-37:24)

E	L	I	H	U	V	X	U	J	F
Z	G	Z	B	U	R	J	O	B	R
J	R	O	T	A	I	D	E	M	I
P	L	F	D	M	C	A	K	K	E
N	L	P	U	D	M	C	O	K	N
K	L	A	T	Y	T	P	M	E	D
U	M	O	D	S	I	W	I	P	S
O	M	G	N	L	L	W	T	Z	O
W	I	C	K	E	D	L	Y	Y	J
F	S	B	C	S	B	J	E	Y	F

ELIHU

GOD

WICKEDLY

EMPTY TALK

JOB

WISDOM

FRIENDS

MEDIATOR

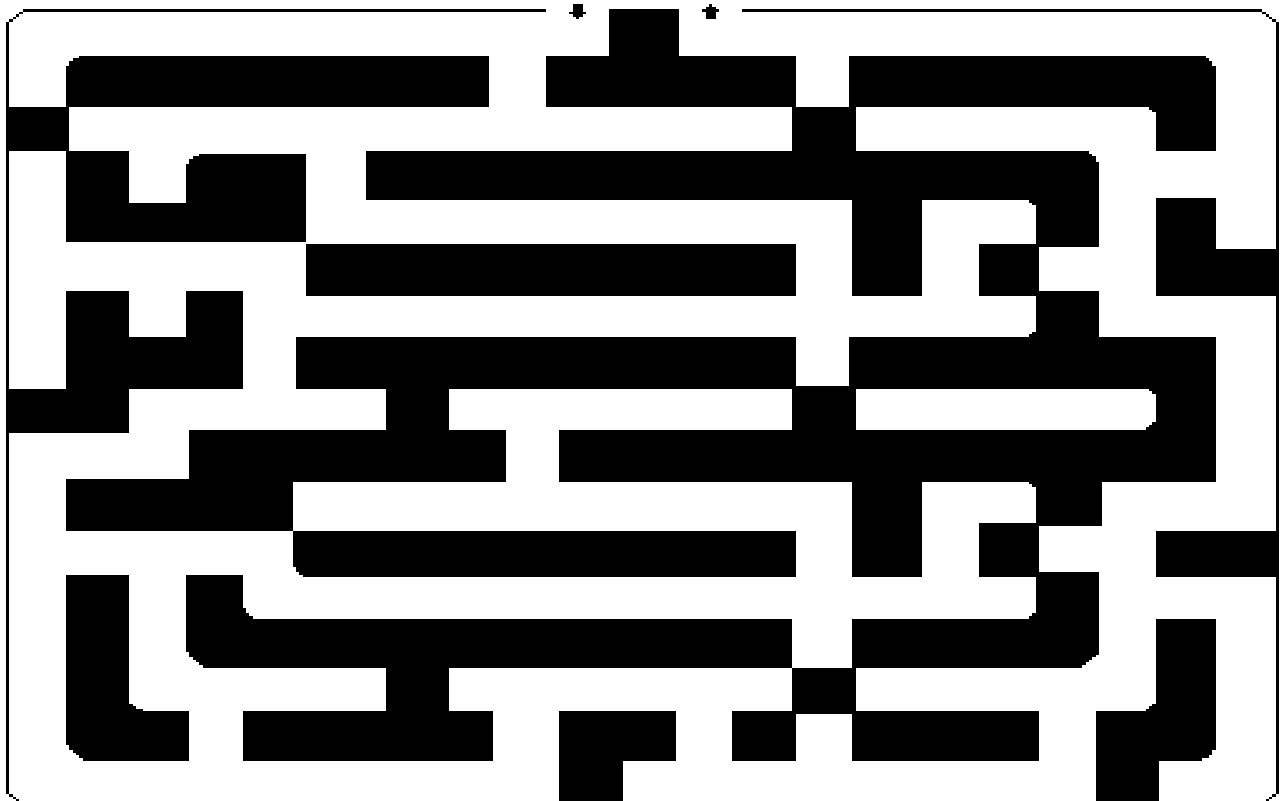

139. ELIHU CONTRADICTS JOB'S FRIENDS

(JOB 32:1-37:24)

MEMORY VERSE:

"Surely God will never do wickedly, nor will the Almighty pervert justice." JOB 34:12

FILL IN THE BLANKS:

1. "The wrath of Elihu, the son of Barachel the Buzite, of the family of Ram, was aroused against Job; his wrath was aroused because he justified _____ rather than _____."
JOB 32:2

TRUE OR FALSE:

2. "Also against his three friends his wrath was aroused, because they had found no answer, and yet had condemned Job." **JOB 32:3**

TRUE OR FALSE

3. Now because they were years younger than he, Elihu had waited to speak to Job. **JOB 32:4**

TRUE OR FALSE

FILL IN THE BLANK:

4. Elihu said to Job, "If there is a messenger for him, a _____, one among a thousand, to show man His uprightness, then He is gracious to him and says, 'Deliver him from going down to the Pit.' " **JOB 33:23-24**

TRUE OR FALSE:

5. Then Elihu also charged Job, saying, "Men of understanding say to me, wise men who listen to me: 'Job speaks without knowledge, his words are without wisdom.' " **JOB 34:34-35**

TRUE OR FALSE

6. "Surely God will not listen to empty talk, nor will the Almighty regard it." **JOB 35:13**

TRUE OR FALSE

FILL IN THE BLANK:

7. Finally Elihu said to Job, "Listen to this O Job; stand still and consider the wondrous works of _____." **JOB 37:14**

139. ELIHU CONTRADICTS JOB'S FRIENDS (JOB 32:1-37:24)

K P M G O K L Q S I O T Q W P A V Q U H
 H U B M H W H V L T N D P P I F B N D T
 H G P Q S V H P P W I S D O M U G Y L L
 R I M H E J T T U A H D N N Y T C M U U
 V C W V S M Y B A L I Q A K B O Z A F W
 P E N V R M P Q T R U C Y B U H I L E Q
 H U G G V W O T N B W U Q M B M H S L N
 V N K S N E A J Y Z A J U E P S K V Y I
 N M B N G L V I D T F N Q D P D K Y H S
 C K Y B D V C C D O A S T I Y N R K P V
 O U K K P D A T R Z G L H A F E E W O U
 Q Y P K K W L C A N L M K T O I N L I U
 L Y U O S D I J Z K T J T O J R C W R A
 R R Y J P Z O C E O Q T B R W F P W F D
 H F F Q P Z Z W K B H A O C S J C Z Y D
 I H R S R O M Y M E A A J D S K C O X W
 D E T P L W F J D H D U T W I G H A D T
 Y L G M O H M T W F U L R K A H R K F L
 E M E B S Q Q N Q V U E Y I G G E U B A
 D G Y B L I S A P I T N R E W D M N E O

ELIHU	GOD	WICKEDLY
EMPTY TALK	JOB	WISDOM
FRIENDS	MEDIATOR	WRATH

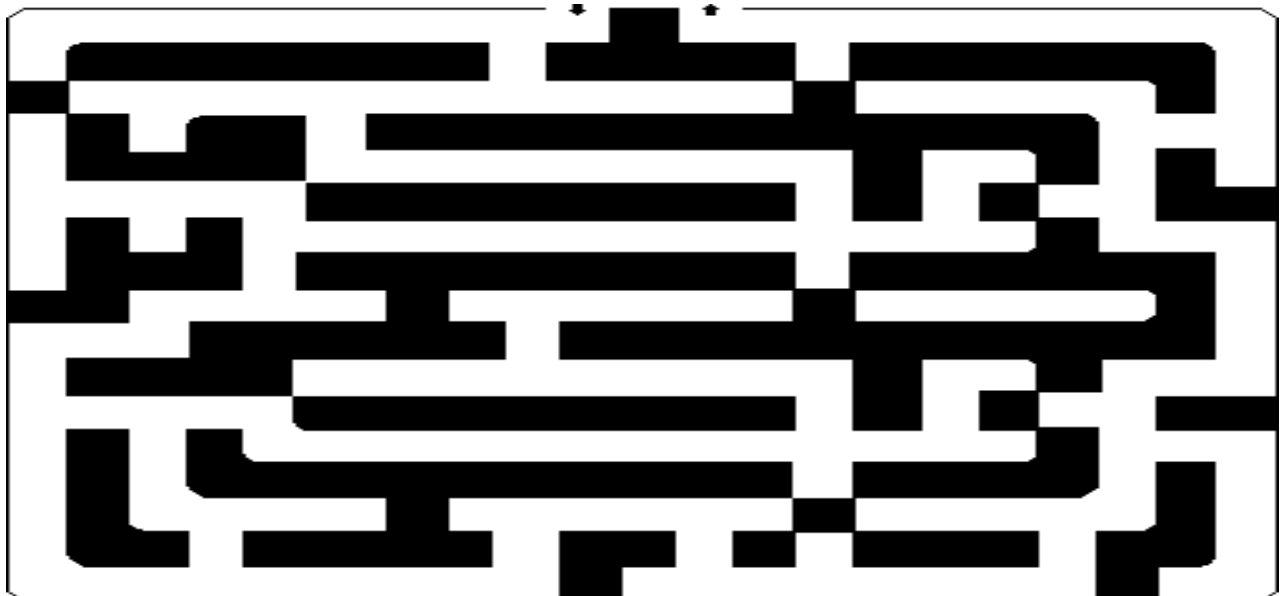

139. ELIHU CONTRADICTS JOB'S FRIENDS

(JOB 32:1-37:24)

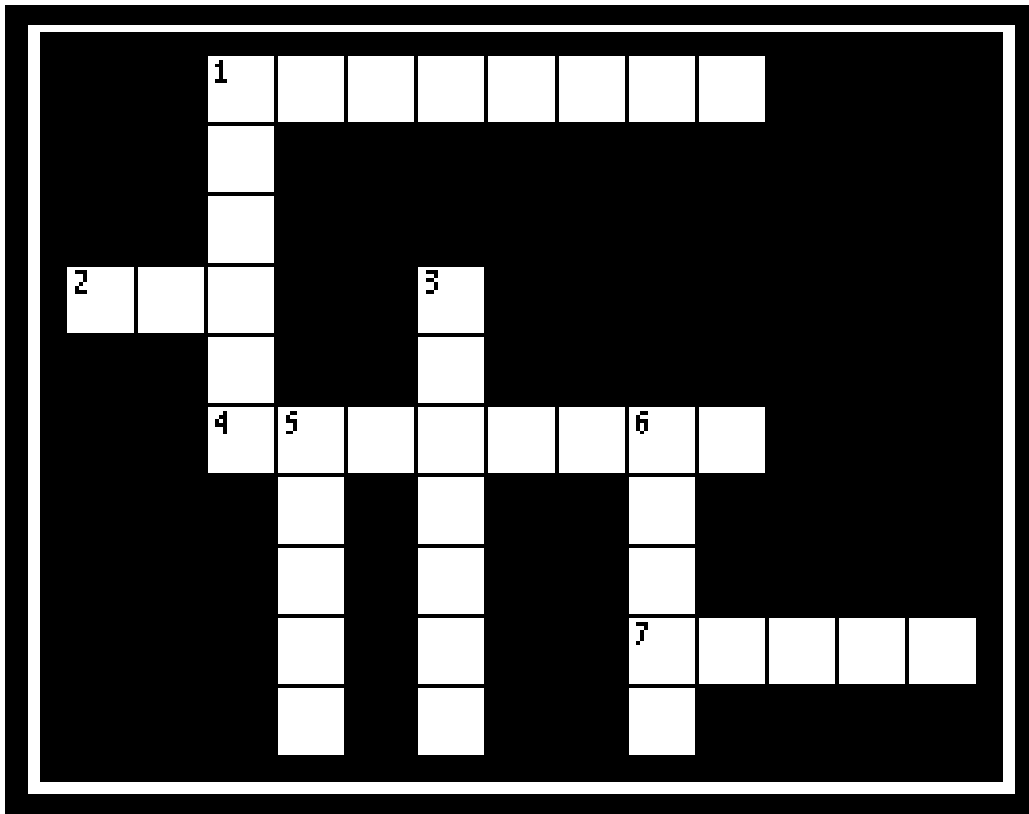

- 5 DOWN "The wrath of _____, the son of Barachel the Buzite, of the family of Ram, was aroused against Job; his wrath was aroused because he justified himself rather than God." **JOB 32:2**
- 3 DOWN "Also against his three _____ his wrath was aroused, because they had found one answer, and yet had condemned Job." **JOB 32:3**
- 6 DOWN "Now because they were years _____ than he, Elihu had waited to speak to Job." **JOB 32:4**
- 4 ACROSS Elihu said to Job, "If there is a messenger for him, a _____, one among a thousand, to show man His uprightness, then He is gracious to him and says, 'Deliver him from going down to the Pit.'" **JOB 33:23-24**
- 1 ACROSS "Surely God will never do _____, nor will the Almighty pervert justice." **JOB 34:12**
- 1 DOWN Then Elihu also charged Job, saying, "Men of understanding say to me, wise men who listen to me: 'Job speaks without knowledge, his words are without _____.'" **JOB 34:34-35**
- 7 ACROSS "Surely God will not listen to _____ talk, nor will the Almighty regard it." **JOB 35:13**
- 2 ACROSS Finally Elihu said to Job, "Listen to this O Job; stand still and consider the wondrous works of _____." **JOB 37:14**

Bible Story 140

THE LORD SPEAKS

JOB 38:1-40:24

140. THE LORD SPEAKS

(JOB 38:1-40:24)



"Then the LORD answered Job out of the whirlwind, and said,
Who is this that darkeneth counsel by words without knowledge?"

JOB 38:1-2

140. THE LORD SPEAKS

(JOB 38:1-40:24)

MEMORY VERSE:

"Shall the one who contends with the Almighty correct Him? " JOB 40:2

TRUE OR FALSE:

1. "The LORD answered Job out of the whirlwind." **JOB 38:1**
TRUE OR FALSE

CIRCLE THE CORRECT WORDS:

2. The LORD asked, "Who is this who darkens counsel by words (**WITH, WITHOUT**) knowledge." **JOB 38:2**
3. Again the LORD said, "Where were you when I laid the foundations of the (**HOUSE, EARTH**)?" **JOB 38:4**
4. Then the LORD asked Job, "Have you (**COMMANDED, WATCHED**) the morning since your days began, and caused the dawn to know its place?" **JOB 38:12**
5. The LORD continued, "Can you lift up your voice to the (**CLOUDS, CROWDS**), that an abundance of water may cover you? Can you send out (**LIGHTS, LIGHTNINGS**), that they may go, and say to you, 'Here we are!'" **JOB 38:34-35**
6. The LORD asked, "Does the (**EAGLE, BEAGLE**) mount up at your command, and make its nest on high?" **JOB 39:27**

"Then Job answered the LORD and said:

'Behold, I am vile; what shall I answer You? I lay my hand over my mouth.' " **JOB 40:3-4**

TRUE OR FALSE:

7. The LORD questioned Job, saying, "Would you condemn Me that you may be justified?" **JOB 40:8**

TRUE OR FALSE

FILL IN THE BLANKS:

8. Furthermore the LORD asked, "Have you an _____ like God?" **JOB 40:9**
9. The LORD said, "Then adorn _____ with majesty and splendor, and array _____ with glory and beauty." **JOB 40:10**
10. Finally the LORD said, "Then I will also confess to you that _____ right hand can save you." **JOB 40:14**

140. THE LORD SPEAKS

(JOB 38:1-40:24)

C L O U D S N Q W U Y F Q D A
J Y W F S B C N L N H B N D D
O D S F O G V Y W U L E I W Y
B B E U O G N A L M I G H T Y
W B S I M U C I W D O H S T S
K P I T F C N M N L I L O R D
H P A M J I D D Z T R T V L M
T Y G S O Z T N A U H L U A U
U F W D K R C S I T F G U O P
O E A N G H N A U W I S I A S
M L H E H K H I O J L O A L E
I I T T A K R S N F Y R N V J
E V R N G R E V A G M U I S E
P O A O D R M Y K L D W A H M
I J E C V E M K E A G L E P W

ALMIGHTY

EAGLE

JUSTIFIED

MOUTH

ARM

EARTH

LIGHTNINGS

SAVE

CLOUDS

FOUNDATIONS

LORD

VILE

CONTENDS

JOB

MORNING

WHIRLWIND

140. THE LORD SPEAKS

(JOB 38:1-40:24)

MEMORY VERSE:

"Shall the one who contends with the Almighty correct Him?" JOB 40:2

TRUE OR FALSE:

1. "The LORD answered Job out of the whirlwind." JOB 38:1

TRUE OR FALSE

FILL IN THE BLANKS:

2. The LORD asked, "Who is this who darkens counsel by words without _____."

JOB 38:2

3. Again the LORD said, "Where were you when I laid the foundations of the _____?"

JOB 38:4

4. Then the LORD asked Job, "Have you _____ the morning since your days began, and _____ the dawn to know its place?"

JOB 38:12

5. The LORD continued, "Can you lift up your voice to the _____, that an abundance of water may cover you? Can you send out _____, that they may go, and say to you, 'Here we are!'"

JOB 38:34-35

6. The LORD asked, "Does the _____ mount up at your command, and make its nest on high?"

JOB 39:27

"Then Job answered the LORD and said: 'Behold, I am vile; what shall I answer You? I lay my hand over my mouth.'" JOB 40:3-4

TRUE OR FALSE:

7. The LORD questioned Job, saying, "Would you condemn Me that you may be justified?"

JOB 40:8

TRUE OR FALSE

CIRCLE THE CORRECT WORD:

8. Furthermore the LORD asked, "Have you an (ARM, EAR) like God?"

JOB 40:9

FILL IN THE BLANKS:

9. The LORD said, "Then adorn _____ with majesty and splendor, and array _____ with glory and beauty."

JOB 40:10

TRUE OR FALSE:

10. Finally the LORD said, "Then I will also confess to you that your own right hand can save you."

JOB 40:14

TRUE OR FALSE

140. THE LORD SPEAKS

(JOB 38:1-40:24)

B R B I E B V M T D G S I Q B B I D N Q
B M L D B L U H V O S S E B V K C I B O
Z E O Z D A I Y I O A O A R E Y P M G V
F W U P V E P Y L K U E R C Z H L O I Y
W G P Z N Z N D E I F I T S U J O O E N
N F W C P C S M O P K L H G U F P F G C
Y Z C O Y S C B J Z I Z C O U Q D U W J
L A P N G L N P Q G S L P W I X Q D K N
N N R T N W N O H S O P K J X H W I O B
D S F E W C P T I U Y E R V Q H J V I L
C H M N Y A N R D T L U E H I M E E L L
V U E D Z I C S L T A V N R B G L M D D
O M T S N D R Y P V F D L Y V Q G N S N
S S O G U Z R Y T G L W N G J W A B U K
K Y S R G S C O V H I F A U B O E A J A
L J L V N D R R L N G I I M O G B S L M
D N M U F I P E D W S I A R M F J P J O
F D E D Y G N R G D K A M R W R C W T U
A Y Z W I P R G Y K I U V L Y W N J B T
B I I E F C E V Q A Q H P E A D V H V H

ALMIGHTY

EAGLE

JUSTIFIED

MOUTH

ARM

EARTH

LIGHTNINGS

SAVE

CLOUDS

FOUNDATIONS

LORD

VILE

CONTENDS

JOB

MORNING

WHIRLWIND

140. THE LORD SPEAKS

(JOB 38:1-40:24)

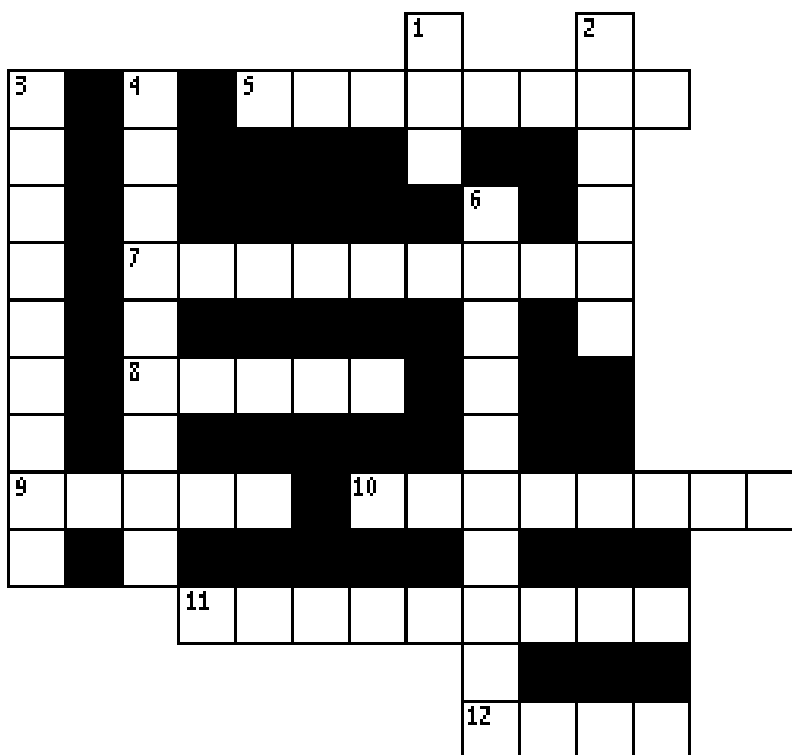

- 7 ACROSS "The LORD answered Job out of the ____." **JOB 38:1**
- 4 DOWN The LORD asked, "Who is this who darkens counsel by words without ____." **JOB 38:2**
- 8 ACROSS Again the LORD said, "Where were you when I laid the foundations of the ____?" **JOB 38:4**
- 11 ACROSS Then the LORD asked Job, "Have you ____ the morning since your days began, and caused the dawn to know its place?" **JOB 38:12**
- 2 DOWN The LORD continued, "Can you lift up your voice to the ____, that an abundance of water may cover you?" **JOB 38:34**
- 6 DOWN Can you send out ____, that they may go, and say to you, 'Here we are!?' " **JOB 38:35**
- 9 ACROSS The LORD asked, "Does the ____ mount up at your command, and make its nest on high?" **JOB 39:27**
- 10 ACROSS "Shall the one who ____ with the Almighty correct Him?" **JOB 40:2**
- 3 DOWN The LORD questioned Job, saying, "Would you condemn Me that you may be ____?" **JOB 40:8**
- 1 DOWN Furthermore the LORD asked, "Have you an ____ like God?" **JOB 40:9**
- 5 ACROSS The LORD said, "Then adorn ____ with majesty and splendor, and array yourself with glory and beauty." **JOB 40:10**
- 12 ACROSS The LORD said, "Then I will also confess to you that your own right hand can ____ you." **JOB 40:14**

Bible Story 141

JOB IS BLESSED

JOB 42:1-17

141. JOB IS BLESSED

(JOB 42:1-17)



"And the LORD turned the captivity of Job, when he prayed for his friends: also the LORD gave Job twice as much as he had before."

JOB 42:10

141. JOB IS BLESSED

(JOB 42:1-17)

MEMORY VERSE:

"I know that You can do everything, and that no purpose of Yours can be withheld from You." JOB 42:2

TRUE OR FALSE:

1. "The LORD restored Job's losses when he prayed for his friends." JOB 42:10
TRUE OR FALSE
2. Indeed the LORD gave Job half as much as he had before. JOB 42:10
TRUE OR FALSE

CIRCLE THE CORRECT WORD:

3. "Then all his brothers, all his sisters, and all those who had been his acquaintances before, came to him and (**ATE, THREW**) food with him in his house." JOB 42:11

TRUE OR FALSE:

4. "They consoled him and comforted him for all the adversity that the LORD had brought upon him." JOB 42:11
TRUE OR FALSE

FILL IN THE BLANKS:

5. "Each one gave him a piece of _____ and each a ring of _____." JOB 42:11

TRUE OR FALSE:

6. "Now the LORD blessed the latter days of Job more than his beginning." JOB 42:12
TRUE OR FALSE
7. But Job had no sons in the latter days of his life. JOB 42:13
TRUE OR FALSE

CIRCLE THE CORRECT WORDS:

8. "In (**ALL, HALF**) the land were found no women so beautiful as the daughters of Job." JOB 42:15
9. "After this Job lived one hundred and forty years, and saw his children and grandchildren for (**TWO, FOUR**) generations." JOB 42:16
10. "So Job died, old and full of (**DAYS, GRAYS**)." JOB 42:17

141. JOB IS BLESSED

(JOB 42:1-17)

C F P J F H K A E U K K N V U
O A L H O H S R P E D I R R G
M H J U S Q U L T C D J Y S F
F A S Q W O H W C D E Y A R P
O E L U F I T U A E B S Y E K
R H B O L E D J S N O U D T D
T Z V A S L L O R D K E J H B
E Y T O O W P R E V L I S G N
D S N O I T A R E N E G I U N
Z S W W D D E R O T S E R A A
Y N S R E H T O R B Q A E D T
Y J O B S E E U C Q K V T F W
R I N G O F G O L D L D A E L
O J H V J B V O H L W Q P J A
J T P M S R E T S I S E T O P

ATE

HOUSE

RESTORED

BEAUTIFUL

JOB

RING OF GOLD

BROTHERS

LORD

SILVER

COMFORTED

OLD

SISTERS

DAUGHTERS

PRAYED

SONS

GENERATIONS

141. JOB IS BLESSED

(JOB 42:1-17)

MEMORY VERSE:

"I know that You can do everything, and that no purpose of Yours can be withheld from You." JOB 42:2

TRUE OR FALSE:

1. "The LORD restored Job's losses when he prayed for his friends." JOB 42:10
TRUE OR FALSE
2. Indeed the LORD gave Job half as much as he had before. JOB 42:10
TRUE OR FALSE

FILL IN THE BLANKS:

3. "Then all his _____, all his _____, and all those who had been his _____ before, came to him and ate food with him in his house." JOB 42:11
4. "They _____ him and _____ him for all the adversity that the LORD had brought upon him." JOB 42:11
5. "Each one gave him a piece of _____ and each a ring of _____." JOB 42:11

TRUE OR FALSE:

6. "Now the LORD blessed the latter days of Job more than his beginning." JOB 42:12
TRUE OR FALSE
7. But Job had no sons in the latter days of his life. JOB 42:13
TRUE OR FALSE
8. "In all the land were found no women so beautiful as the daughters of Job." JOB 42:15
TRUE OR FALSE

FILL IN THE BLANKS:

9. "After this Job lived one hundred and forty years, and saw his children and grandchildren for _____ generations." JOB 42:16
10. "So Job died, old and _____ of days." JOB 42:17

141. JOB IS BLESSED

(JOB 42:1-17)

G O V N B T Q K O K C K E A B O P U J I Z P Q M E
D W P D H D X B J G H U H P H L K X Q S F Z N P A
P H B R F D N C D H R N T A J O J H L G Z F R M E
K Q Q A V G A D B E E C O M F O R T E D L V Q L Q
S I S Z I Q E R W G R U L D Y P F U J J D F G C J
P L J R O C O N S D M O U Y K I Y D E Y A R P S T
P H I E E T Y W E V Q D T S P I T Q T P K H B G V
R T C M H T Q K S R N L W S G B W T W Z L N I E S
X Y T E N U S I I B A U Q A E R B P K F U E F Y E
O O R D H J U I A G Y T N M T R E L M S Y E W U T
S S C W I H Q E S C M F I U K E A J L R E M L W K
L A J Q U S O P G Z A L I O G W U B U E E J J I N
K V W X A K O U W H S Y S N N G T J G T J Q B A B
W C C I F S T N S K V H V S P S I H C H A V B C Y
V A Y O F M H R S E Y B U E S T F T V G V E K L Z
J L J T N J T I I K K O U J O N U J U U W V J P A
X O T A T S T Y A N W I A M T W L Y B A U V W A R
W Z N L Q T O B F R G R D G W I U R N D O L U I U
E M A B H A B L U E L O D O I U G D H B Z A M E E
L F S Z A O R B E N W F F V H M H C B N R I J Y D
V M L Z J A R D T D W Y W G J F D G A K A L Y A K
D Q P N U U W P R C Z M T S O L N S U M M R R Q G
D S U W U E P P O O O D L P O L V Q V Z Z U T A C
Z S I L V E R Y M V L F A T D O D U A L B U T O M
Z Q T O T N N F J C A B O W U E S M E I T C C Y N

ATE

GENERATIONS

RESTORED

BEAUTIFUL

HOUSE

RING OF GOLD

BROTHERS

JOB

SILVER

COMFORTED

LORD

SISTERS

CONSOLED

OLD

SONS

DAUGHTERS

PRAYED

141. JOB IS BLESSED

(JOB 42:1-17)

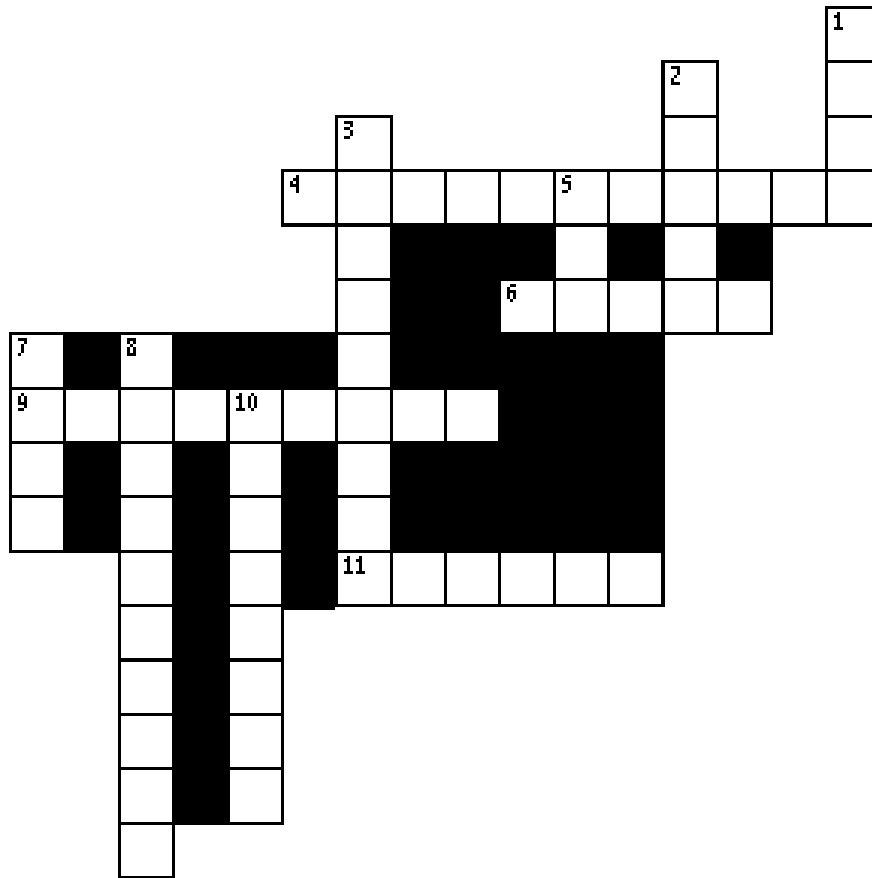

- 8 DOWN "I know that You can do _____, and that no purpose of Yours can be withheld from You." **JOB 42:2**
- 10 DOWN "The LORD _____ Job's losses when he prayed for his friends." **JOB 42:10**
- 2 DOWN "Indeed the LORD gave Job _____ as much as he had before." **JOB 42:10**
- 5 DOWN "Then all his brothers, all his sisters, and all those who had been his acquaintances before, came to him and _____ food with him in his house." **JOB 42:11**
- 9 ACROSS "They consoled him and comforted him for all the _____ that the LORD had brought upon him." **JOB 42:11**
- 7 DOWN "Each one _____ him a piece of silver and each a ring of gold." **JOB 42:11**
- 11 ACROSS "Now the LORD blessed the _____ days of Job more than his beginning." **JOB 42:12**
- 6 ACROSS "He also had _____ sons and three daughters." **JOB 42:13**
- 3 DOWN "In all the land were found no women so _____ as the daughters of Job." **JOB 42:15**
- 4 ACROSS "After this Job lived one hundred and forty years, and saw his children and grandchildren for four _____." **JOB 42:16**
- 1 DOWN "So Job died, old and full of _____." **JOB 42:17**

Bible Story 142

SANCTIFIED LIPS

ISAIAH 6:1-13

142. SANCTIFIED LIPS (ISAIAH 6:1-13)



"Then flew one of the seraphims unto me, having a live coal in his hand, *which* he had taken with the tongs from off the altar: And he laid *it* upon my mouth, and said, Lo, this hath touched thy lips; and thine iniquity is taken away, and thy sin purged."

ISAIAH 6:6-7

142. SANCTIFIED LIPS

(ISAIAH 6:1-13)

MEMORY VERSE:

"In the year that King Uzziah died, I saw the Lord sitting on a throne, high and lifted up, and the train of His robe filled the temple." ISAIAH 6:1

CIRCLE THE CORRECT WORD:

1. "Above it stood seraphim; each one had six (**HANDS, WINGS**): with two he covered his face, with two he covered his feet, and with two he flew." **ISAIAH 6:2**

"And one cried to another and said: 'Holy, holy, holy is the LORD of hosts; the whole earth is full of His glory!' " **ISAIAH 6:3**

TRUE OR FALSE:

2. "And the posts of the door were shaken by the voice of him who cried out, and the house was filled with smoke." **ISAIAH 6:4**

TRUE OR FALSE

"Then I said: 'Woe is me, for I am undone! Because I am a man of unclean lips, and I dwell in the midst of people of unclean lips; for my eyes have seen the King, the LORD of hosts.' " **ISAIAH 6:5**

CIRCLE THE CORRECT WORDS:

3. "Then one of the seraphim flew to me, having in his hand a live (**COAL, BOWL**) which he had taken with the tongs from the altar." **ISAIAH 6:6**

4. "And he touched my (**MOUTH, EARS**) with it." **ISAIAH 6:7**

He said, "Behold, this has touched your lips; your iniquity is taken away, and your sin is purged." ISAIAH 6:7

"Also I heard the voice of the Lord, saying: 'Whom shall I send, and who will go for Us?' " **ISAIAH 6:8**

FILL IN THE BLANKS:

5. "Then I said, 'Here I am! _____.'" **ISAIAH 6:8**

142. SANCTIFIED LIPS

(ISAIAH 6:1-13)

I S A I A H Q M U M
E E K T A A D O T X
J N A E L C N U M N
O D K W P P V T O O
U H O L Y L S H E B
D E I F I T C N A S
G E L P M E T C L U
F D S L P V M Z O L
S E R A P H I M R P
K B A L A O C L D M

COAL

LORD

SERAPHIM

HOLY

MOUTH

TEMPLE

ISAIAH

SANCTIFIED

UNCLEAN

LIPS

SEND

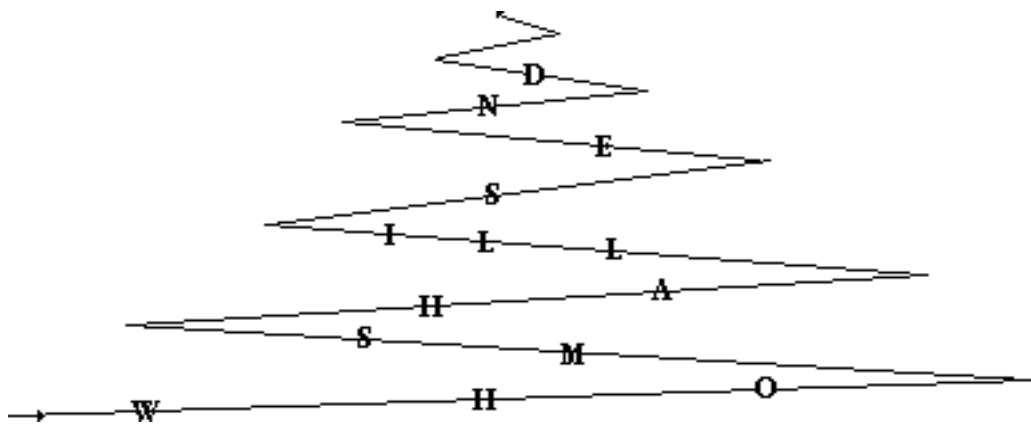

WRITE DOWN THE LETTERS FROM ABOVE AS YOU COME TO THEM ON THE LINES BELOW

" _____ ?"

142. SANCTIFIED LIPS

(ISAIAH 6:1-13)

MEMORY VERSE:

"In the year that King Uzziah died, I saw the Lord sitting on a throne, high and lifted up, and the train of His robe filled the temple." ISAIAH 6:1

UNDERLINE THE CORRECT ANSWER:

1. "Above it stood seraphim; each one had six wings:" **ISAIAH 6:2**
 - a. with two he covered his face
 - b. with two he covered his feet
 - c. and with two he flew
 - d. all of the above

"And one cried to another and said: 'Holy, holy, holy is the LORD of hosts; the whole earth is full of His glory!' " ISAIAH 6:3

TRUE OR FALSE:

2. "And the posts of the door were shaken by the voice of him who cried out, and the house was filled with smoke." **ISAIAH 6:4**

TRUE OR FALSE

"Then I said: 'Woe is me, for I am undone! Because I am a man of unclean lips, and I dwell in the midst of people of unclean lips; for my eyes have seen the King, the LORD of hosts.' " ISAIAH 6:5

FILL IN THE BLANKS:

3. "Then one of the seraphim flew to me, having in his hand a live _____ which he had taken with the tongs from the altar." **ISAIAH 6:6**

4. "And he touched my _____ with it." **ISAIAH 6:7**

He said, "Behold, this has touched your lips; your iniquity is taken away, and your sin is purged." ISAIAH 6:7

"Also I heard the voice of the Lord, saying: 'Whom shall I send, and who will go for Us?' " ISAIAH 6:8

FILL IN THE BLANKS:

5. "Then I said, 'Here I am! _____ .'" **ISAIAH 6:8**

142. SANCTIFIED LIPS

(ISAIAH 6:1-13)

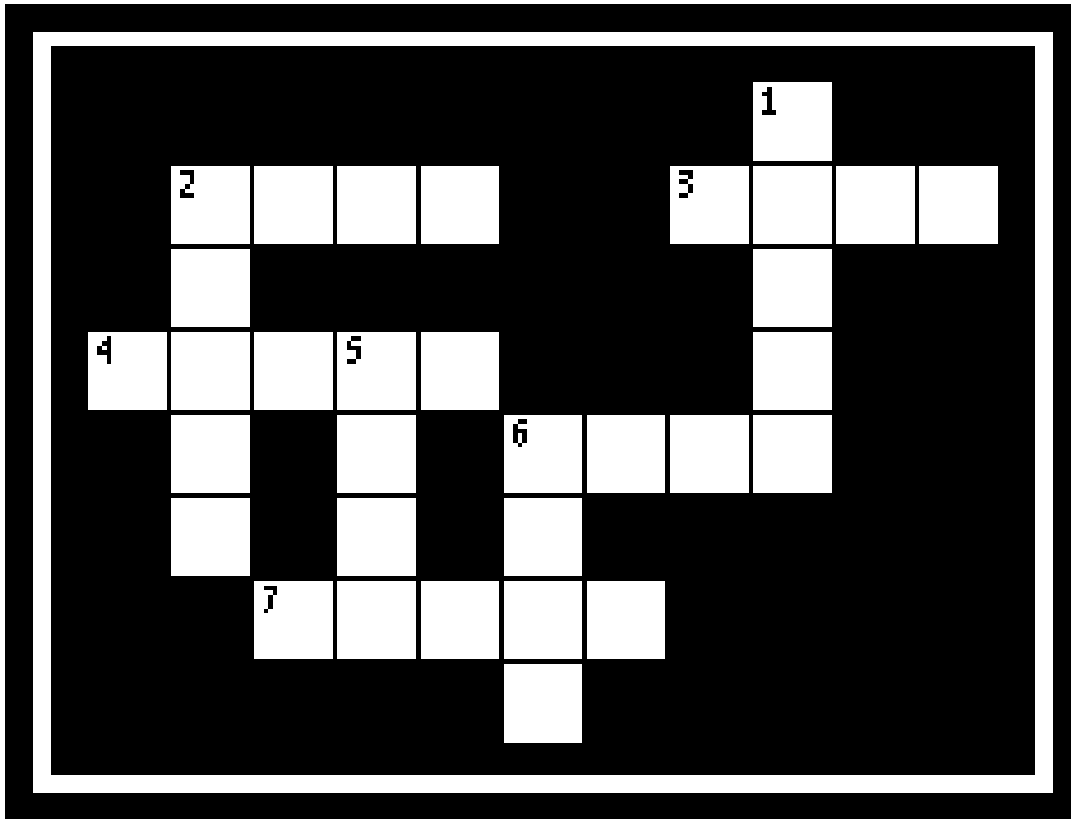

- 6 DOWN "In the year that King Uzziah died, I saw the _____ sitting on a throne, high and lifted up, and the train of His robe filled the temple." **ISAIAH 6:1**
- 1 DOWN "Above it stood seraphim; each one had six _____: with two he covered his face, with two he covered his feet, and with two he flew." **ISAIAH 6:2**
- 7 ACROSS "And one cried to another and said: 'Holy, holy, holy is the LORD of hosts; the whole earth is full of His _____!'" **ISAIAH 6:3**
- 2 DOWN "And the posts of the door were shaken by the voice of him who cried out, and the house was filled with _____." **ISAIAH 6:4**
- 3 ACROSS "Then I said: 'Woe is me, for I am undone! Because I am a man of unclean lips, and I dwell in the midst of people of unclean lips; for my eyes have seen the _____, the LORD of hosts.'" **ISAIAH 6:5**
- 5 DOWN "Then one of the seraphim flew to me, having in his hand a live _____ which he had taken with the tongs from the altar." **ISAIAH 6:6**
- 6 ACROSS He said, "Behold, this has touched your _____; your iniquity is taken away, and your sin is purged." **ISAIAH 6:7**
- 4 ACROSS "Also I heard the _____ of the Lord, saying: 'Whom shall I send, and who will go for Us?' "**ISAIAH 6:8**
- 2 ACROSS "Then I said, 'Here I am! _____ me.'" **ISAIAH 6:8**

Bible Story 143

**UNTO US
A CHILD IS BORN**

ISAIAH 9:1-7

143. UNTO US A CHILD IS BORN
(ISAIAH 9:1-7)



"For unto us a child is born, unto us a son is given: and the government shall be upon his shoulder: and his name shall be called Wonderful, Counsellor, The mighty God, The everlasting Father, The Prince of Peace."

ISAIAH 9:6

143. UNTO US A CHILD IS BORN

(ISAIAH 9:1-7)

W U O D Z H N J I H Z K E T S E
 O Q O R F Z V T O A C Q F A T V
 N S C E H I Q B V W C J J N F E
 D S F U N V D O G Y T H G I M R
 E I R O L E S N U O C B T R A L
 R L K W G V T I Q P Q B E P Y A
 F S B J L B A A Z P I R J I Y S
 U J Y N G Q Q M U E W B Z Q O T
 L E C A E P F O E C N I R P F I
 K F N S R N O S A S Z T Z D V N
 T F D L I H C L N G K H K J B G
 D O M Z Q Y F T M D D G C Q O F
 G O V E R N M E N T R I T R R A
 Y P H K I E H Y G E O L I I N T
 H E L B P L P L F P L K O L P H
 W F T G H Q S D F G D D V P L E
 P M H G T R H K P L M F D N W R

BORN

LORD

CHILD

MIGHTY GOD

COUNSELOR

PRINCE OF PEACE

GOVERNMENT

SON

LIGHT

WONDERFUL

EVERLASTING FATHER



143. UNTO US A CHILD IS BORN (ISAIAH 9:1-7)

MEMORY VERSE:

"And His name will be called Wonderful, Counselor, Mighty God, Everlasting Father, Prince of Peace." ISAIAH 9:6

The LORD spoke to Isaiah saying...

FILL IN THE BLANKS:

1. "The people who walked in darkness have seen a great _____." ISAIAH 9:2
2. "Those who dwelt in the land of the shadow of death, upon them a _____ has shined." ISAIAH 9:2
3. "For unto us a _____ is born, unto us a _____ is given." ISAIAH 9:6

TRUE OR FALSE:

4. "And the government will be upon His shoulder." ISAIAH 9:6
TRUE OR FALSE

CIRCLE ALL OF THE CORRECT WORDS:

5. "And His name will be called..." ISAIAH 9:6

Wonderful

Counselor

Mighty God

John

Everlasting Father

Prince of Peace

TRUE OR FALSE:

6. "Of the increase of His government and peace there will be no end." ISAIAH 9:7
TRUE OR FALSE

FILL IN THE BLANK:

7. "The _____ of the LORD of hosts will perform this." ISAIAH 9:7

143. UNTO US A CHILD IS BORN

(ISAIAH 9:1-7)

B O O H I E I T Y P O C A F L P D E T L S Y N B C
 Y J S T C M O D Q I M C K B A T U P P J G E E I S
 K Q L Y T D N D T Y J H U E O W O K L T J E E F G
 P S K O C E H Q W N K P R I N C E O F P E A C E E
 U P E A J W V O U B E R N H A B L J J W P J M W Y
 Y M W C W Q N E Q B G M S O N H O E M A N A J L U
 F B V V A D I C R P H E N T P J U F B K D L I H C
 K B J C E E U U T L G M U R A Y I Y J M Z V Q J W
 T O X R Y X P J H P A Q D L E K I T H L F K V B I
 G H F A J I A K T Y D S L U D V B W T U B U E B A
 E U W L L O R D T F D N T W Y P O U J G X O V K C
 L S E O T T F S R O V O U I S G R G Y C K Z V J L
 Y S L Z N A N M R J B Y G Q N L W G R V M X L K P
 G R C M A L R J W W G M F Y M G A H D U Z A A U A
 M V V O S B O T P S C A L N T K F E C B X M I M I
 Q N D F U Z B A N S Z S Y I U H G A Z N I Z L X E
 H G D M L N F A K I H V H S B G G X T H Z B R Y Y
 V D Z Q P Z S U B A K Y F V S P T I G H F T U R A
 V P Z S U N T E C G K K O U E S K V M R E P U T Q
 G K O Q T K Q E L W R W I U J O W S S A Z R C T A
 S S W V N O H N D O E L R A M T I U Q U X Z Q C O
 N P H P D B A Q W A R W F D G W U X U V D F N M Y
 B P Q B R H U T K F N W Y D O I M H M A K V R P E
 K R I Q A F U N I U C Z X W V H F U J E L F U M A
 K X L J Z V T A E T V O D T S J O Q Q I U H K L E

BORN

LORD

PRINCE OF PEACE

CHILD

MIGHTY GOD

SON

COUNSELOR

NAME

WONDERFUL

EVERLASTING FATHER

PEACE

ZEAL

GOVERNMENT



143. UNTO US A CHILD IS BORN

(ISAIAH 9:1-7)

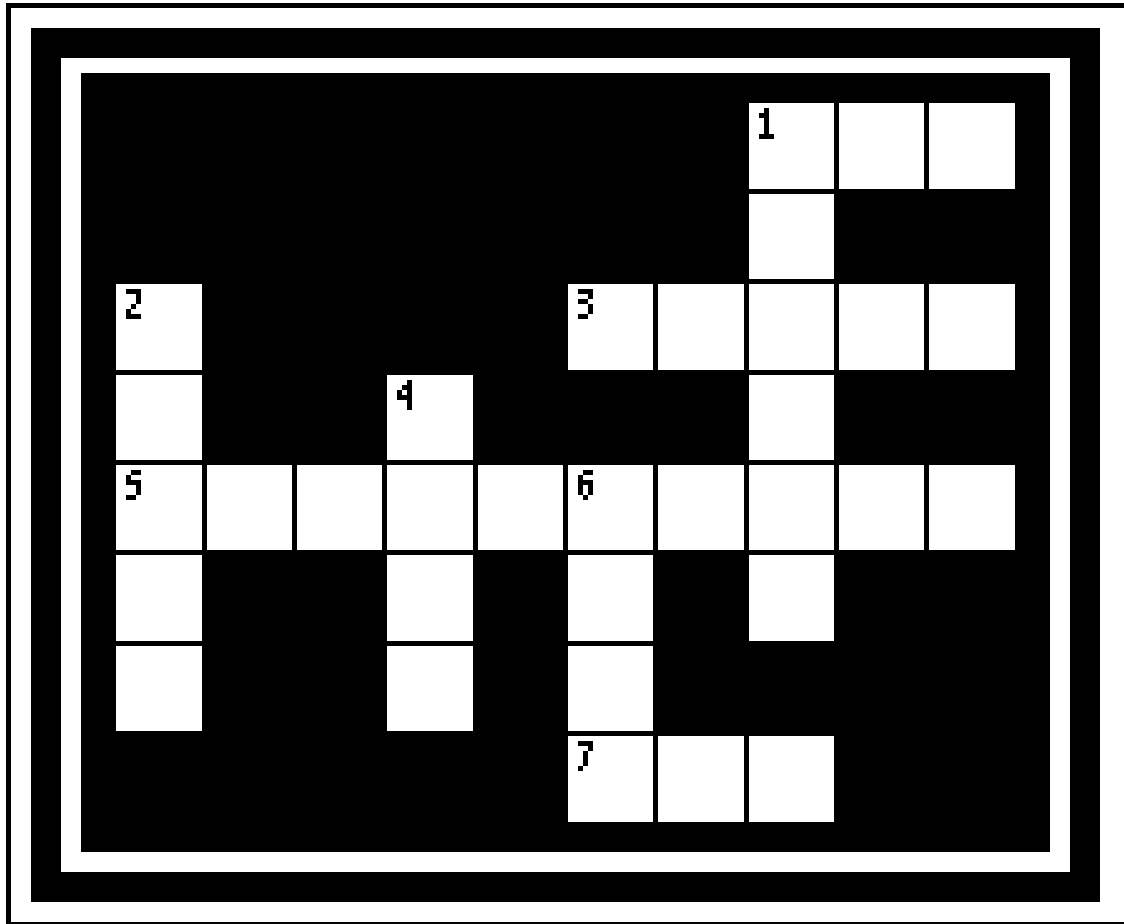

- 2 DOWN "The people who walked in darkness have seen a great ____." **ISAIAH 9:2**
- 1 DOWN "Those who dwelt in the land of the shadow of death, upon them a light has ____." **ISAIAH 9:2**
- 3 ACROSS "For unto us a _____ is born." **ISAIAH 9:6**
- 1 ACROSS "Unto us a _____ is given." **ISAIAH 9:6**
- 5 ACROSS "And the ____ will be upon His shoulder." **ISAIAH 9:6**
- 6 DOWN "And His ____ will be called Wonderful, Counselor, Mighty God, Everlasting Father, Prince of Peace." **ISAIAH 9:6**
- 7 ACROSS "Of the increase of His government and peace there will be no ____." **ISAIAH 9:7**
- 4 DOWN "The ____ of the LORD of hosts will perform this." **ISAIAH 9:7**

Bible Story 144

PEACE ON EARTH

ISAIAH 11:1-9

144. PEACE ON EARTH

(ISAIAH 11:1-9)



"The wolf also shall dwell with the lamb, and the leopard shall lie down with the kid; and the calf and the young lion and the fatling together; and a little child shall lead them."

ISAIAH 11:6

144. PEACE ON EARTH

(ISAIAH 11:1-9)

MEMORY VERSE:

"There shall come forth a Rod from the stem of Jesse, and a Branch shall grow out of his roots."
ISAIAH 11:1

CIRCLE THE CORRECT WORDS:

THE SAME WORD IS USED TO FILL IN EACH OF THE BLANKS-CIRCLE THAT WORD

1. "The _____ of the LORD shall rest upon Him, the _____ of wisdom and understanding, the _____ of counsel and might, the _____ of knowledge and of the fear of the LORD." **ISAIAH 11:2**
SPIRIT **SIGHT**

2. "His (**FRIGHT, DELIGHT**) is in the fear of the LORD." **ISAIAH 11:3**

FILL IN THE BLANK:

3. "He shall not judge by the sight of His eyes, nor decide by the hearing of His ears; but with _____ He shall judge the poor, and decide with equity for the meek of the earth."
ISAIAH 11:3-4

TRUE OR FALSE:

CIRCLE T FOR TRUE AND CIRCLE F FOR FALSE-

- | | | | |
|--|-------------|----------|----------|
| 4. He shall strike the earth with the rod of His mouth | vs 4 | T | F |
| With the breath of His lips He shall slay the wicked | vs 4 | T | F |
| Righteousness shall be the belt of His loins | vs 5 | T | F |
| Faithfulness shall be the belt of His waist | vs 5 | T | F |
| | | | |
| 5. The wolf shall hurt the lamb | vs 6 | T | F |
| The leopard shall lie down with the young goat | vs 6 | T | F |
| The calf and the young lion and the fatling will fight | vs 6 | T | F |
| A little child shall lead them | vs 6 | T | F |
| The cow and the bear shall moo | vs 7 | T | F |
| Their young ones shall lie down together | vs 7 | T | F |
| The lion shall eat straw like the ox | vs 7 | T | F |
| | | | |
| 6. The nursing child shall play by the cobra's hole | vs 8 | T | F |
| The weaned child shall put his hand in the viper's den | vs 8 | T | F |
| | | | |
| 7. They shall not hurt nor destroy in all My holy mountain | vs 9 | T | F |
| The earth shall be full of the knowledge of the LORD | | | |
| as the waters cover the sea | vs 9 | T | F |

144. PEACE ON EARTH

(ISAIAH 11:1-9)

F H T R A E R Z B K I F M J E
H P E F M O A C R C Q A A E U
N H L H D Q W C B T D Y Z A W
G R O O T Z X Q K I J Y S W D
X Z N I A T N U O M Y L O H W
G I N P X U P I E O Q O H L Y
C V V J T A H W F E G D U J P
H V Q T Y C E Z J T R F M Z Z
I S S E N S U O E T H G I R W
L B T A L N S K T A I V W W B
D Q R B I M G K E N L P S P M
R B A I O G D Q J T I R I P S
F A I T H F U L N E S S V J W
Q Y Q A V F E J Z R S S O H U
I D R O L H P B Z P T V J G F

BRANCH
CHILD
EARTH
FAITHFULNESS

HOLY MOUNTAIN
JUDGE
LORD
RIGHTEOUSNESS

ROD
ROOT
SPIRIT

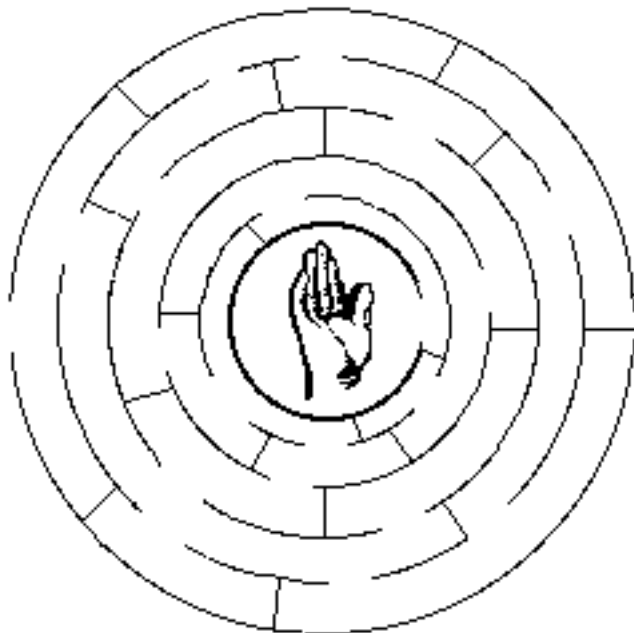

144. PEACE ON EARTH

(ISAIAH 11:1-9)

MEMORY VERSE:

"There shall come forth a Rod from the stem of Jesse, and a Branch shall grow out of his roots."
ISAIAH 11:1

CIRCLE THE CORRECT WORDS:

THE SAME WORD IS USED TO FILL IN EACH OF THE BLANKS-CIRCLE THAT WORD

1. "The _____ of the LORD shall rest upon Him, the _____ of wisdom and understanding, the _____ of counsel and might, the _____ of knowledge and of the fear of the LORD." **ISAIAH 11:2**

SPIRIT

SIGHT

2. "His (**FRIGHT, DELIGHT**) is in the fear of the LORD." **ISAIAH 11:3**

TRUE OR FALSE:

3. "He shall not judge by the sight of His eyes, nor decide by the hearing of His ears; but with righteousness He shall judge the poor, and decide with equity for the meek of the earth." **ISAIAH 11:3-4**

TRUE OR FALSE

FILL IN THE BLANKS:

4. He shall strike the earth with the rod of His _____ **vs 4**
With the _____ of His lips He shall slay the wicked **vs 4**
_____ shall be the belt of His loins **vs 5**
_____ shall be the belt of His waist **vs 5**
5. The wolf shall _____ with the lamb **vs 6**
The _____ shall lie down with the young goat **vs 6**
The calf and the young lion and the fatling _____ **vs 6**
A little _____ shall lead them **vs 6**
The cow and the bear shall _____ **vs 7**
Their _____ ones shall lie down together **vs 7**
The lion shall eat _____ like the ox **vs 7**
6. The nursing child shall play by the _____ hole **vs 8**
The weaned child shall put his hand in the _____ den **vs 8**
7. They shall not hurt nor destroy in all My _____ mountain **vs 9**
The earth shall be _____ of the knowledge of the LORD
as the waters cover the sea **vs 9**

144. PEACE ON EARTH

(ISAIAH 11:1-9)

B S C E Y O N Z P A C J R F J Z P O M I
C T O O R O S I J N C T P V E W L O R D
P T N R H C Z V T M Q R T P A B Y F D T
O O W J B F H V B G I O I I W M B L L E
G T T S Q R B B I F W D Q S R C H I L D
E W S S E N L U F H T I A F L I D L S J
U A I T S B Z Q A H Z E D V Z W P M V K
P F R A S Y F Y M A K J J M X U R S R K
M A W T I N H E X W K Z Q E G D U J C P
N M P Z H M N L T X Q Z R A P F C S M Z
R F P S L H G N Y P J K I Z J I G Z L Y
P S S E N S U O E T H G I R H H R F B Y
D H W D S L X V L E B C L S G C G P R O
C K Q J J D G Q I S B T S H E N N G A J
U N T Q F R R T O G R I T M U A G K C F
G C A I F E Q A V D B O F M W R Z B W A
H O L Y M O U N T A I N A S D B J U J H
D U U K O U I Q Q E K T Y V W X P K U A
T Q U T P W P F Z P E A Y O Y G N C K H
A D H D E J H H U Z F N O J P Y U U O Z

BRANCH

HOLY MOUNTAIN

ROD

CHILD

JUDGE

ROOT

EARTH

LORD

SPIRIT

FAITHFULNESS

RIGHTEOUSNESS



144. PEACE ON EARTH

(ISAIAH 11:1-9)

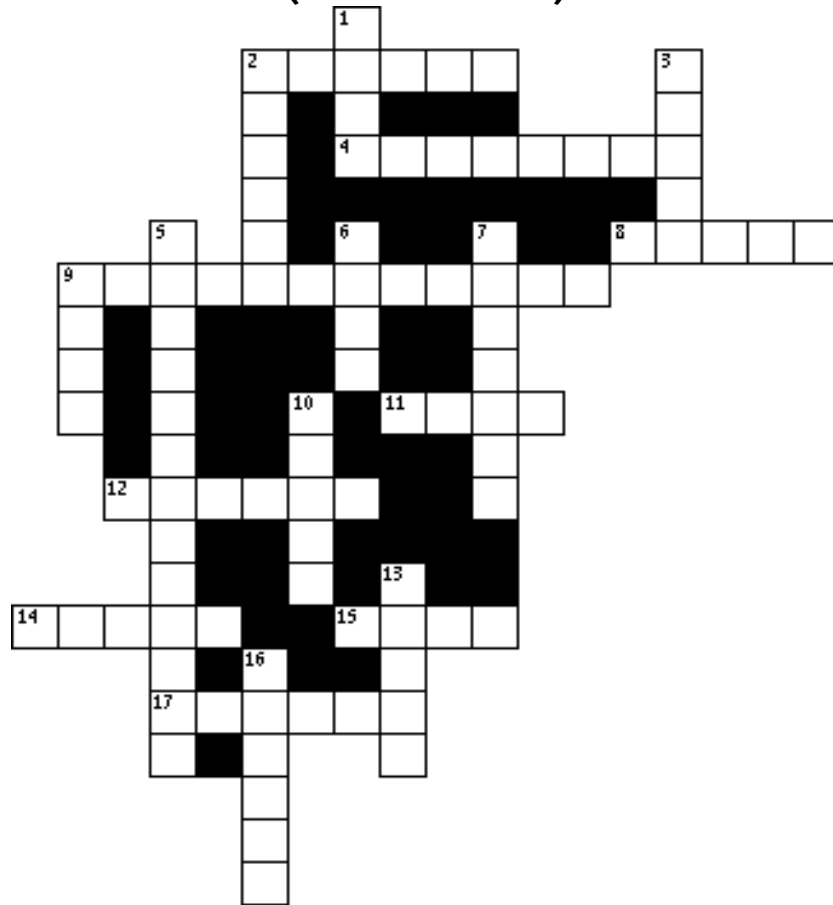

- 2 DOWN "There shall come forth a Rod from the stem of Jesse, and a _____ shall grow out of his roots." **ISAIAH 11:1**
- 17 ACROSS "The _____ of the LORD shall rest upon Him, the Spirit of wisdom and understanding, the Spirit of counsel and might, the Spirit of knowledge and of the fear of the LORD." **ISAIAH 11:2**
- 9 DOWN "His delight is in the _____ of the LORD." **ISAIAH 11:3**
- 5 DOWN "He shall not judge by the sight of His eyes, nor decide by the hearing of His ears; but with _____ He shall judge the poor." **ISAIAH 11:3-4**
- 13 DOWN "He shall strike the earth with the rod of His _____." **ISAIAH 11:4**
- 2 ACROSS "With the _____ of His lips He shall slay the wicked." **ISAIAH 11:4**
- 1 DOWN "Righteousness shall be the _____ of His loins." **ISAIAH 11:5**
- 9 ACROSS "_____ shall be the belt of His waist." **ISAIAH 11:5**
- 8 ACROSS "The wolf also shall _____ with the lamb." **ISAIAH 11:6**
- 7 DOWN "The _____ shall lie down with the young goat." **ISAIAH 11:6**
- 4 ACROSS "The calf and the young lion and the fatling _____." **ISAIAH 11:6**
- 11 ACROSS "A little child shall _____ them." **ISAIAH 11:6**
- 10 DOWN "The cow and the bear shall _____." **ISAIAH 11:7**
- 14 ACROSS "Their _____ ones shall lie down together." **ISAIAH 11:7**
- 3 DOWN "The lion shall eat _____ like the ox." **ISAIAH 11:7**
- 12 ACROSS "The nursing child shall play by the _____ hole." **ISAIAH 11:8**
- 16 DOWN "The weaned child shall put his hand in the _____ den." **ISAIAH 11:8**
- 15 ACROSS "They shall not hurt nor destroy in all My _____ mountain." **ISAIAH 11:9**
- 6 DOWN "The earth shall be _____ of the knowledge of the LORD as the waters cover the sea." **ISAIAH 11:9**

Bible Story 145

**CHRIST'S
SACRIFICE IS
FORETOLD**

ISAIAH 53:2-12

145. CHRIST'S SACRIFICE IS FORETOLD
(ISAIAH 53:2-12)

" But he was wounded for our transgressions,
he was bruised for our iniquities; the
chastisement for our peace was upon him, and
with his stripes we are healed"

ISAIAH 53:5



145. CHRIST'S SACRIFICE IS FORETOLD

(ISAIAH 53:2-12)

MEMORY VERSE:

"All we like sheep have gone astray; we have turned, every one, to his own way; and the LORD has laid on Him the iniquity of us all." ISAIAH 53:6

"Behold, My Servant..."

TRUE OR FALSE:

1. "He is despised and rejected by men, a man of sorrows acquainted with grief." ISAIAH 53:3
TRUE OR FALSE
2. "And we hid, as it were, our faces from Him; He was despised, and we did not esteem Him." ISAIAH 53:3
TRUE OR FALSE

CIRCLE THE CORRECT WORDS:

3. "He was wounded for (OUR, HIS) transgressions, He was bruised for (OUR, HIS) iniquities." ISAIAH 53:5
4. "The chastisement for (OUR, HIS) peace was upon Him, and by (OUR, HIS) stripes we are healed"
ISAIAH 53:5

FILL IN THE BLANKS:

5. " _____ we like sheep have gone astray; We have turned, _____, _____, to his own way; And the LORD has laid on Him the iniquity of us _____." ISAIAH 53:6

UNDERLINE THE CORRECT ANSWERS:

6. "He was oppressed and He was afflicted..." ISAIAH 53:7
 - a. yet He opened not His mouth
 - b. but He defended Himself

"He was led as a lamb to the slaughter, and as a sheep before its shearers is silent..." ISAIAH 53:7

 - a. So He opened not His mouth
 - b. He defended Himself

TRUE OR FALSE:

7. "He was cut off from the land of the living; for the transgressions of My people He was stricken." ISAIAH 53:8
TRUE OR FALSE
8. "They made His grave with the wicked- but with the rich at His death." ISAIAH 53:9
TRUE OR FALSE

FILL IN THE BLANKS:

9. "By His knowledge My righteous Servant shall _____ many, for He shall bear their _____ iniquities."
ISAIAH 53:11

145. CHRIST'S SACRIFICE IS FORETOLD

(ISAIAH 53:2-12)

S H E A L E D W P Z S H E E P
E T Q Y Z J H B Y J G D M E Y
R I R O S E G M B P K L L S Y
V O B M A L E W D N J B B E O
A T D E D N U O W U E R P P J
N A I F H A U U R O S U A I F
T N L V M W W R C F U I C R A
T R S R M L D F E L S S W T H
E D E S I P S E D J B E J S A
J P T S S Z W I G L E D U J H
Z I Y F I T S U J M L C T K Z
Z Q F V V X Y M R S K S T K Y
S T R I C K E N G Z C V O E N
K D A M O P P G N F L R I P D
C J Y A J J Z Y G P M C T Z J

BRUISED

JUSTIFY

SHEEP

DESPISED

LAMB

STRICKEN

HEALED

REJECTED

STRIPES

JESUS

SERVANT

WOUNDED

145. CHRIST'S SACRIFICE IS FORETOLD

(ISAIAH 53:2-12)

MEMORY VERSE:

"All we like sheep have gone astray; we have turned, every one, to his own way; and the LORD has laid on Him the iniquity of us all." ISAIAH 53:6

"Behold, My Servant..."

TRUE OR FALSE:

1. "He is despised and rejected by men, a man of sorrows acquainted with grief." **ISAIAH 53:3**
TRUE OR FALSE
2. "And we hid, as it were, our faces from Him; He was despised, and we did not esteem Him." **ISAIAH 53:3**
TRUE OR FALSE

FILL IN THE BLANKS:

3. "He was wounded for _____ transgressions, He was bruised for _____ iniquities." **ISAIAH 53:5**
4. "The chastisement for _____ peace was upon Him, and by _____ stripes we are healed" **ISAIAH 53:5**
5. "_____ we like sheep have gone astray; we have turned, _____, _____ to his own way; and the LORD has laid on Him the iniquity of us _____." **ISAIAH 53:6**

UNDERLINE THE CORRECT ANSWERS:

6. "He was oppressed and He was afflicted..." **ISAIAH 53:7**
 - a. yet He opened not His mouth
 - b. but He defended Himself

"He was led as a lamb to the slaughter, and as a sheep before its shearers is silent..." **ISAIAH 53:7**

- a. So He opened not His mouth
- b. He defended Himself

TRUE OR FALSE:

7. "He was cut off from the land of the living; for the transgressions of My people He was stricken." **ISAIAH 53:8**
TRUE OR FALSE
8. "They made His grave with the wicked- but with the rich at His death." **ISAIAH 53:9**
TRUE OR FALSE

FILL IN THE BLANKS:

9. "By His knowledge My righteous Servant shall _____ many, for He shall bear their _____ iniquities." **ISAIAH 53:11**
10. "He was numbered with the transgressors, and _____ of many, and made intercession for the transgressors." **ISAIAH 53:12**

145. CHRIST'S SACRIFICE IS FORETOLD

(ISAIAH 53:2-12)

U O J Q Q T H Q F P V E U P F S U A Q B
Q T N A V R E S J I H A W Y L V K H O K
S O N I T Y A I T Q S H D B L R O Z A S
S C S P A L W W E D V E D E M C I Y W U
I F Z H Q I M Z J J M A W D D M T N V H
L K D E S I U R B Q A L Y R S N E J M P
S B K Z F O P K Z R Z E P C Z L U T F E
J Y B I H V E K Z I S D Z G F B J O S V
F N Z V P Q S Q K L H W W R P W K P W A
M M F V J Z S H C S R L B G G A K L W R
O H H B T U G J E T M E M N K C P J U L
U D E S I P S E D E P Z J G B Y Z C D W
T L N Q B A D B T F P R W E W F Y V S J
H D G Y I N S B I A S P U Z C I Y T J U
F R T E A T E S O Y V J F J P T O W H O
O E G L R M P R U Y O H I E C S E H Q E
S T R I C K E N T S J G V P Q U J D O P
P U P N M G Z B A O E A X N M J F P E T
E E B M A L R K N F R J G U D W A J W C
S W R V P F R E R G J E Y O L J H H E S

BRUISED

DESPISED

GRAVE

HEALED

JESUS

JUSTIFY

LAMB

MOUTH

REJECTED

SERVANT

SHEEP

STRICKEN

STRIPES

WOUNDED

145. CHRIST'S SACRIFICE IS FORETOLD (ISAIAH 53:2-12)

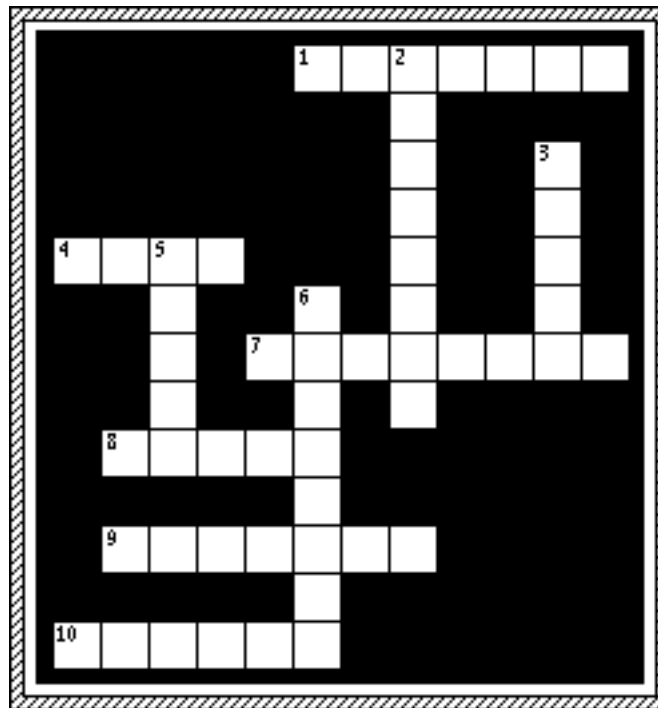

- 7 ACROSS "He is despised and _____ by men, a man of sorrows acquainted with grief." **ISAIAH 53:3**
- 6 DOWN "And we hid , as it were, our faces from Him; He was _____ and we did not esteem Him." **ISAIAH 53:3**
- 9 ACROSS "He was wounded for our transgressions, He was _____ for our iniquities." **ISAIAH 53:5**
- 10 ACROSS "The chastisement for our peace was upon Him, and by His stripes we are _____." **ISAIAH 53:5**
- 8 ACROSS "All we like _____ have gone astray; we have turned, every one, to his own way; and the LORD has laid on Him the iniquity of us all." **ISAIAH 53:6**
- 5 DOWN "He was oppressed and He was afflicted yet He opened not His _____." **ISAIAH 53:7**
- 4 ACROSS "He was led as a _____ to the slaughter, and as a sheep before its shearers is silent, so He opened not His mouth." **ISAIAH 53:7**
- 2 DOWN "He was cut off from the land of the living; for the transgressions of My people He was _____." **ISAIAH 53:8**
- 3 DOWN "They made His _____ with the wicked- but with the rich at His death." **ISAIAH 53:9**
- 1 ACROSS "By His knowledge My righteous Servant shall _____ many, for He shall bear their iniquities." **ISAIAH 53:11**

Bible Story 146

**NEW HEAVENS
AND A NEW EARTH**

ISAIAH 65:17-25

146. NEW HEAVENS AND A NEW EARTH (ISAIAH 65:17-25)



"For behold, I create new heavens and a new earth."
ISAIAH 65:17

146. NEW HEAVENS AND A NEW EARTH (ISAIAH 65:17-25)

MEMORY VERSE:

"For behold, I create new heavens and a new earth." ISAIAH 65:17

"Thus says the LORD GOD..."

FILL IN THE BLANKS:

1. "Behold, I create new _____ and a new _____." ISAIAH 65:17

TRUE OR FALSE:

2. The former shall be remembered and come to mind. ISAIAH 65:17
TRUE OR FALSE

CIRCLE THE CORRECT WORDS:

3. "Be (GLAD, SAD) and (WEEP, REJOICE) forever in what I create." ISAIAH 65:18

4. "For as the days of a tree so shall the days of My people, and My elect shall long (ENJOY, DESTROY) the work of their hands." ISAIAH 65:22

TRUE OR FALSE:

5. "They shall not labor in vain." ISAIAH 65:23
TRUE OR FALSE

6. "They shall be the descendants of the blessed of the LORD, and their offspring with them."
ISAIAH 65:23

TRUE OR FALSE

CIRCLE THE CORRECT WORDS:

7. "The wolf and the lamb shall (BARK, FEED) together." ISAIAH 65:25

8. "The (LION, SHARK) shall eat straw like the ox." ISAIAH 65:25

9. "(DUST, RUST) shall be the serpent's food." ISAIAH 65:25

10. "'They (SHALL, SHALL NOT) hurt nor destroy in all My holy mountain,' says the LORD." ISAIAH 65:25

146. NEW HEAVENS AND A NEW EARTH (ISAIAH 65:17-25)

L X G S U L L K F N V J W W R
 O G Z Z M A K P A J T H U E H
 R Y J F M B O Z H T W Q D B T
 D P P B D P E C I O J E R U R
 G Y N I A T N U O M L I O N A
 O B N P L A I Y A F R U I T E
 D D U G S C T Y H P H O S S L
 W R O K V W E S E S U O H U W
 B D L I H C M E L A S U R E J
 M C F B R E T A E R C A J O J
 W G S N E V A E H L P W Y H U
 U R L B C J J O Z J W V H P O
 R E M E M B E R E D O M Q E E
 F G L K M D K J Y C L F O V P
 I N M C N A M D L O F S E A T

CREATE

JERUSALEM

MOUNTAIN

EARTH

JOY

OLD MAN

FRUIT

LAMB

REJOICE

HEAVENS

LION

REMEMBERED

HOUSES

LORD GOD

WOLF

CHILD



146. NEW HEAVENS AND A NEW EARTH

(ISAIAH 65:17-25)

MEMORY VERSE:

"For behold, I create new heavens and a new earth; and the former shall not be remembered or come to mind." ISAIAH 65:17

"Thus says the LORD GOD..."

FILL IN THE BLANKS:

1. "Behold, I create new _____ and a new _____." ISAIAH 65:17

TRUE OR FALSE:

2. The former shall be remembered and come to mind. ISAIAH 65:17

TRUE OR FALSE

FILL IN THE BLANKS:

3. "Be _____ and _____ forever in what I create." ISAIAH 65:18

4. "For as the days of a tree so shall the days of My people, and My elect shall long _____ the work of their hands." ISAIAH 65:22

TRUE OR FALSE:

5. "They shall not labor in vain." ISAIAH 65:23

TRUE OR FALSE

6. "They shall be the descendants of the blessed of the LORD, and their offspring with them." ISAIAH 65:23

TRUE OR FALSE

FILL IN THE BLANKS:

7. "The _____ and the _____ shall feed together." ISAIAH 65:25

8. "The _____ shall eat straw like the ox." ISAIAH 65:25

9. "_____ shall be the serpent's food." ISAIAH 65:25

10. "'They shall not _____ nor _____ in all My holy mountain,' says the LORD." ISAIAH 65:25

146. NEW HEAVENS AND A NEW EARTH (ISAIAH 65:17-25)

O P D V Q S W B F J Y C O W B H W I S M
 J P D C J L Q H T P Q D J A G R Z R V U
 Q R Z A I P M F Q R E M E M B E R E D P
 S J E L H U N E H S U W W F C E O F U S
 P O Z T C O I V L M Q K S S E S U O H E
 M S O O A T L I A A T I S U Z M A Y U J
 B L W Z T E T Y U J S E I T H Q K X A M
 B K H M C N R O M T H U A O K N T D D G
 O J O Y C D A C E O T P R M K Y N F D O
 H W Q F W H L N U C U I N E R M U B W V
 S H I M J O I H T A I N G A J A D E T S
 S V E Q W R L L T A T O T J M S L H L P
 R J L A Y A B F D U R Y J A E D U T A T
 V X H S V Z Z I D E R B D E I V L L O W
 N W T Q B E Z U D N W B O K R N F O A B
 G E Y M J E N A Q Q P F G G N Y L U P H
 D L A V T N N S C P R P D H C K Y W A J
 P L O P N M O F Q U N P R G V W H Q D Y
 K E A R T H K I I N W Y O D C L X N Y K
 S V A B A D O T L A B F L V C W O I S P

CHILD

CREATE

EARTH

FRUIT

HEAVENS

HOLY MOUNTAIN

HOUSES

JERUSALEM

JOY

LAMB

LION

LORD GOD

OLD MAN

REJOICE

REMEMBERED

WOLF



146. NEW HEAVENS AND A NEW EARTH (ISAIAH 65:17-25)

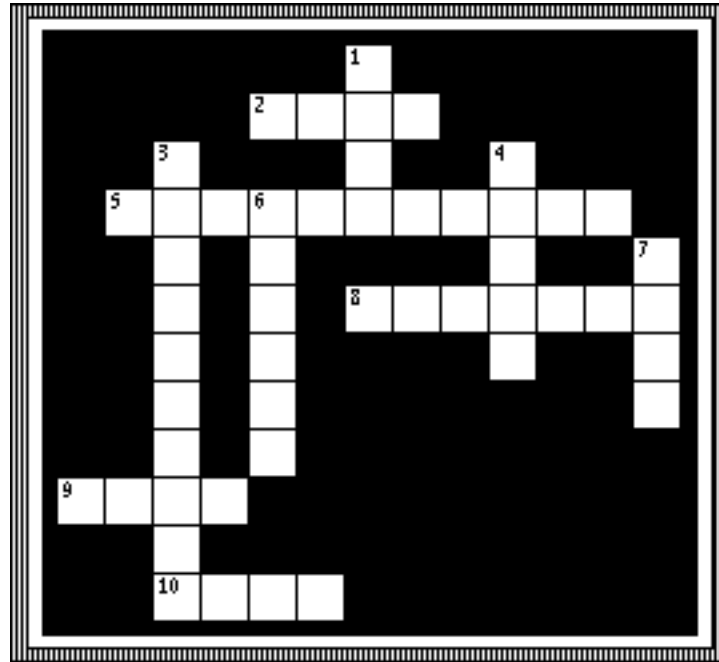

- 6 DOWN "Behold, I _____ new heavens and a new earth." **ISAIAH 65:17**
- 3 DOWN "The former shall not be _____ or come to mind." **ISAIAH 65:17**
- 8 ACROSS "Be glad and _____ forever in what I create." **ISAIAH 65:18**
- 4 DOWN "For as the days of a tree so shall the days of My people, and My elect shall long _____ the work of their hands." **ISAIAH 65:22**
- 2 ACROSS "They shall not labor in _____." **ISAIAH 65:23**
- 5 ACROSS "They shall be the _____ of the blessed of the LORD, and their offspring with them." **ISAIAH 65:23**
- 7 DOWN "The wolf and the lamb shall _____ together." **ISAIAH 65:25**
- 1 DOWN "The _____ shall eat straw like the ox." **ISAIAH 65:25**
- 10 ACROSS "_____ shall be the serpent's food." **ISAIAH 65:25**
- 9 ACROSS "'They shall not _____ nor destroy in all My holy mountain,' says the LORD." **ISAIAH 65:25**

Bible Story 147

THE CALLING OF JEREMIAH

JEREMIAH 1:1-12

147. THE CALLING OF JEREMIAH

(JEREMIAH 1:1-12)



"Then said I, Ah, Lord GOD! behold, I cannot speak: for I *am* a child.
But the LORD said unto me, Say not, I *am* a child: for thou shalt go to all
that I shall send thee, and whatsoever I command thee thou shalt speak."

JEREMIAH 1:6-7

147. THE CALLING OF JEREMIAH

(JEREMIAH 1:1-12)

MEMORY VERSE:

"Before I formed you in the womb I knew you; before you were born I sanctified you; and I ordained you a prophet to the nations." JEREMIAH 1:5

"Then the word of the LORD came to me, saying:..." JEREMIAH 1:4

FILL IN THE BLANKS:

1. "Before I _____ you in the womb I knew you; before you were _____ I sanctified you; and I ordained you a prophet to the _____ nations." **JEREMIAH 1:5**

TRUE OR FALSE:

2. Then Jeremiah said, "Ah, Lord God! Behold, I cannot speak, for I am a youth." **JEREMIAH 1:6**
TRUE OR FALSE
3. And the LORD said to Jeremiah, "It is right for you to say, 'I am a youth.' For you cannot go to all to whom I send you, and whatever I command you, you cannot speak." **JEREMIAH 1:7**
TRUE OR FALSE

CIRCLE THE CORRECT WORD:

4. "Do not be afraid of their (**WEAPONS, FACES**), for I am with you to deliver you." says the LORD." **JEREMIAH 1:8**

"Then the LORD put forth His hand and touched my mouth, and the LORD said to me..."
JEREMIAH 1:9

TRUE OR FALSE:

5. "Behold, I have put My words in your mouth." **JEREMIAH 1:9**
TRUE OR FALSE

CIRCLE THE CORRECT WORDS:

6. "Moreover the word of the LORD came to me, saying, 'Jeremiah, what do you see?' And I said, 'I see a branch of an (**ALMOND, APPLE**) tree.'" **JEREMIAH 1:11**
7. "Then the LORD said to me, 'You have seen well, for I (**AM NOT, AM**) ready to perform My word.'" **JEREMIAH 1:12**

147. THE CALLING OF JEREMIAH

(JEREMIAH 1:1-12)

K A E P S Z T Q M Y
 Q Q R E E K A D O D
 Y T E H P O R P U R
 I O B F J C N J T O
 W J U J Z T R Q H L
 E E R T D N O M L A
 Z B K T H I P R S Y
 K D R O W O I I T O
 J E R E M I A H F F
 K B S E C A F L A V

ALMOND TREE
 FACES
 JEREMIAH

LORD
 MOUTH
 PROPHET

SPEAK
 WORD
 YOUTH

WRITE DOWN ALL THE LETTERS EXCEPT X AS YOU COME TO THEM

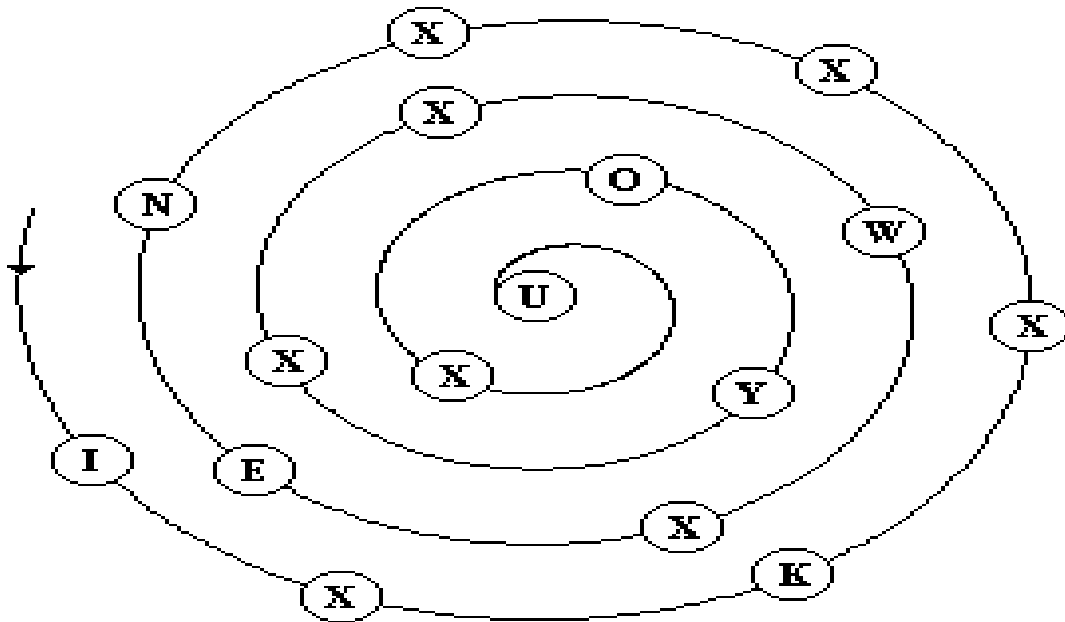

"Before I formed you in the womb...

-----"
 JEREMIAH 1:5

147. THE CALLING OF JEREMIAH

(JEREMIAH 1:1-12)

MEMORY VERSE:

"Before I formed you in the womb I knew you; before you were born I sanctified you; and I ordained you a prophet to the nations." JEREMIAH 1:5

"Then the word of the LORD came to me, saying:..." JEREMIAH 1:4

FILL IN THE BLANKS:

1. "Before I _____ you in the womb I knew you; before you were _____ I sanctified you; and I ordained you a prophet to the _____ nations." **JEREMIAH 1:5**

TRUE OR FALSE:

2. Then Jeremiah said, "Ah, Lord God! Behold, I cannot speak, for I am a youth."
JEREMIAH 1:6

TRUE OR FALSE

3. And the LORD said to Jeremiah, "It is right for you to say, 'I am a youth.' For you cannot go to all to whom I send you, and whatever I command you, you cannot speak." **JEREMIAH 1:7**

TRUE OR FALSE

FILL IN THE BLANKS:

4. "'Do not be afraid of their _____, for I am with you to deliver you.' says the LORD."
JEREMIAH 1:8

"Then the LORD put forth His hand and touched my mouth, and the LORD said to me..."
JEREMIAH 1:9

5. "Behold, I have put _____ in your mouth." **JEREMIAH 1:9**

6. "Moreover the word of the LORD came to me, saying, 'Jeremiah, what do you see?' And I said, 'I see a branch of an _____ tree.'" **JEREMIAH 1:11**

CIRCLE THE CORRECT WORD(S):

7. "Then the LORD said to me, 'You have seen well, for I (**AM NOT**, **AM**) ready to perform My word.'" **JEREMIAH 1:12**

147. THE CALLING OF JEREMIAH

(JEREMIAH 1:1-12)

P V S N P J O V Q Y D I B A D
 U V P G D B W C V J R T H F Q
 Y K M A R E H A P T A A F F C
 F G A A L M I L B N H T U O Y
 K S N E P M Q F Q A Z L V T U
 T C B D P W O O I S E B I Q J
 H N B P R S H N J T M Z O H K
 G B O H T E I A D D C Z N A S
 E P H T O L L Z I T R N H U M
 Y K R U S V H M I M R O A U J
 G K S O L D T F C L E E W S T
 M O S M P D Y M T P D R E T A
 Q J R K K H O Q C U W N E T A
 L O R D W Z E S J T Q K I J U
 H Q V S V Z A T W N X O U D E

ALMOND TREE
 BRANCH
 JEREMIAH
 LORD

MOUTH
 PROPHET
 SANCTIFIED

SPEAK
 WORD
 YOUTH

WRITE DOWN ALL THE LETTERS EXCEPT X AS YOU COME TO THEM

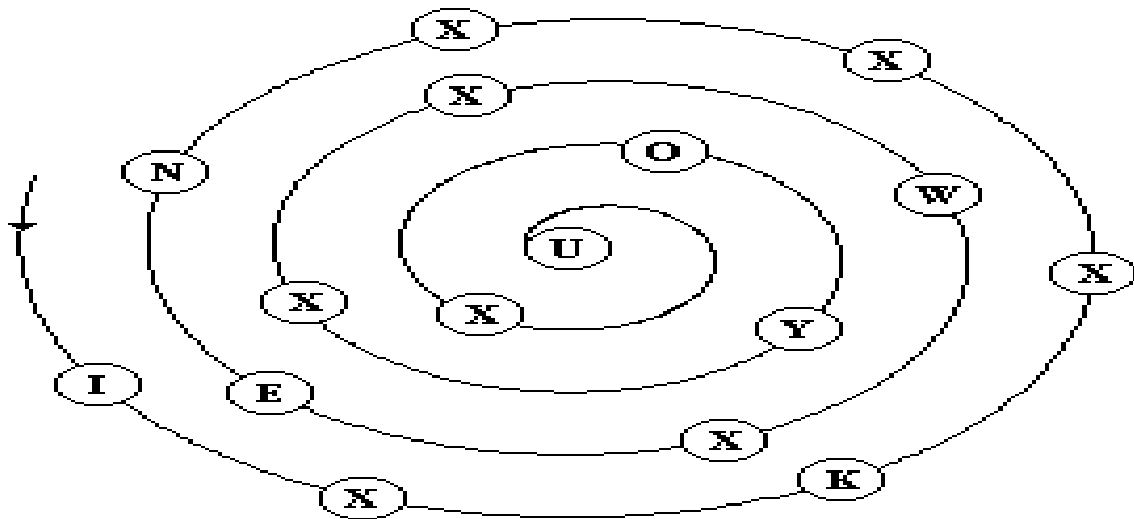

"Before I formed you in the womb...

-----"

JEREMIAH 1:5

147. THE CALLING OF JEREMIAH

(JEREMIAH 1:1-12)

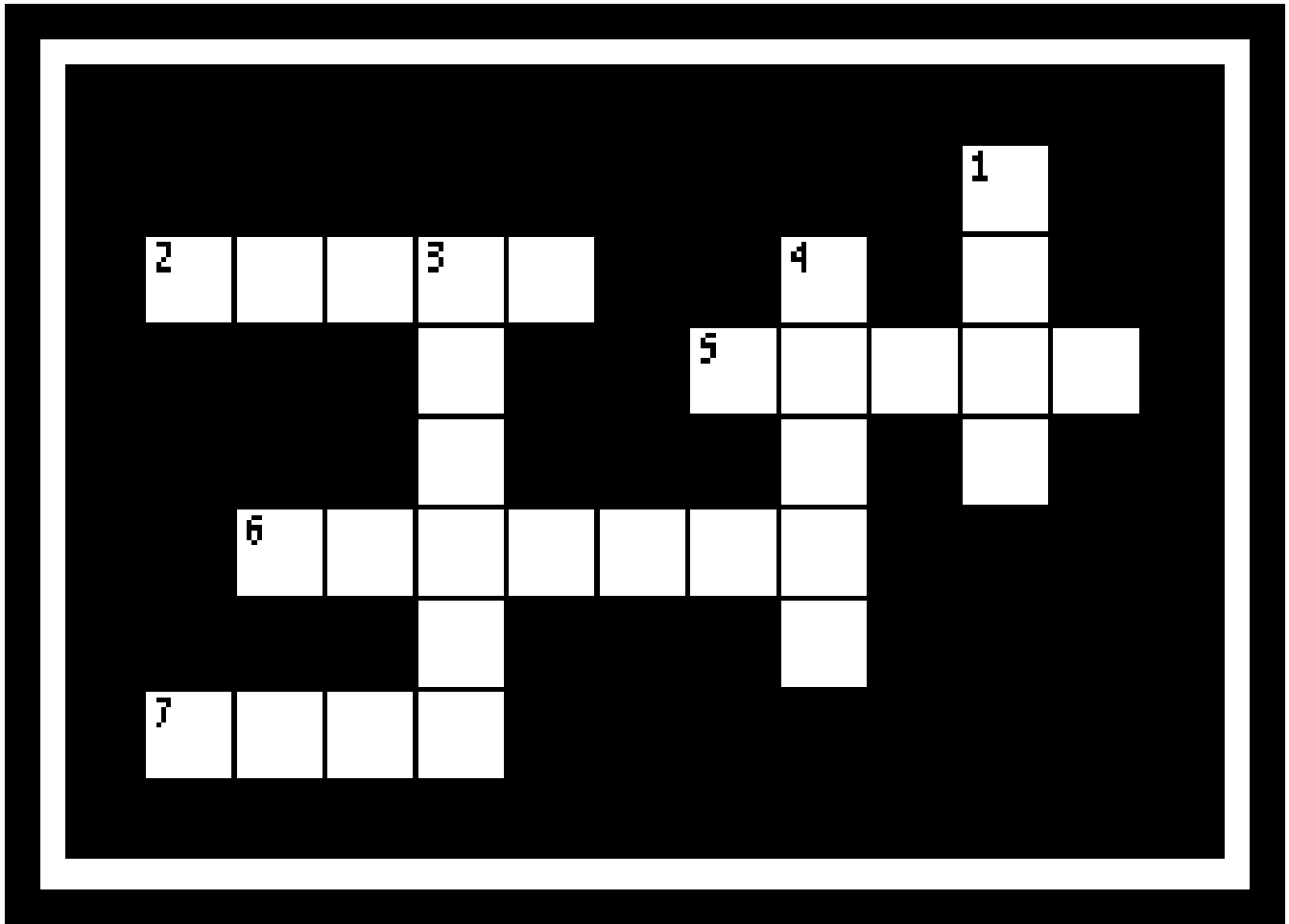

- 6 ACROSS "Before I formed you in the womb I knew you; before you were born I sanctified you; and I ordained you a _____ to the nations." **JEREMIAH 1:5**
- 5 ACROSS Then Jeremiah said, "Ah, Lord God! Behold, I cannot speak, for I am a _____." **JEREMIAH 1:6**
- 2 ACROSS And the LORD said to Jeremiah, "Do not say, 'I am a youth.' For you shall go to all to whom I send you, and whatever I command you, you shall _____." **JEREMIAH 1:7**
- 1 DOWN "'Do not be afraid of their faces, for I am _____ you to deliver you.' says the LORD." **JEREMIAH 1:8**
- 4 DOWN "Behold, I have put My words in your _____." **JEREMIAH 1:9**
- 3 DOWN "Moreover the word of the LORD came to me, saying, 'Jeremiah, what do you see?' And I said, 'I see a branch of an _____ tree.'" **JEREMIAH 1:11**
- 7 DOWN "Then the LORD said to me, 'You have seen well, for I am ready to perform My _____.'" **JEREMIAH 1:12**

Bible Story 148

THE TRUE AND LIVING GOD

JEREMIAH 10:1-16

148. THE TRUE AND LIVING GOD

(JEREMIAH 10:1-16)



"But the LORD *is* the true God, he *is* the living God, and an everlasting king: at his wrath the earth shall tremble, and the nations shall not be able to abide his indignation."

JEREMIAH 10:10

148. THE TRUE AND LIVING GOD

(JEREMIAH 10:1-16)

MEMORY VERSE:

"But the LORD is the true God; He is the living God and the everlasting King."

JEREMIAH 10:10

"Hear the word which the LORD speaks to you, O house of Israel. Thus says the LORD:..." JEREMIAH 10:1-2

CONCERNING THE PAGAN GODS:

FILL IN THE BLANK:

1. "For one cuts a _____ from the forest, the work of the hands of the workman, with the ax."
JEREMIAH 10:3

TRUE OR FALSE:

2. "They decorate it with copper and brass." JEREMIAH 10:4
TRUE OR FALSE
3. "They fasten it with nails and hammers so that it will not topple." JEREMIAH 10:4
TRUE OR FALSE

CIRCLE THE CORRECT WORDS:

4. "They are upright, like a (PEACH, PALM) tree." JEREMIAH 10:5
5. "They (CAN, CANNOT) speak; they must be carried, because they (CAN, CANNOT) go by themselves." JEREMIAH 10:5

"But the LORD is the true God..."

TRUE OR FALSE:

6. "He is the living God and the everlasting King." JEREMIAH 10:10
TRUE OR FALSE
7. "He has made the earth by His power." JEREMIAH 10:12
TRUE OR FALSE

CIRCLE THE CORRECT WORDS:

8. "For He is the Maker of (NO, ALL) things." JEREMIAH 10:16

TRUE OR FALSE:

9. "The LORD of hosts is His name." JEREMIAH 10:16
TRUE OR FALSE

148. THE TRUE AND LIVING GOD

(JEREMIAH 10:1-16)

H G N I K O R H V T I Q W C R
K T H J S O E N L P A Z X Q B
N I E Q S C U G O K O U P I K
C W R I I F W X R A A W E W E
T P S L I A N G D Q M E E Z F
U R J K L K J R B F M A P R J
G P E T S B N D Q D L O G S T
O W S E J Y S Q E E T N S K E
D G N I V I L I M C Y M G K J
Q Q T D F N Z A Y H O G D Q Z
D T A Y F M N P E P L R E J Z
C A Z H O H K H L R E K A M K
S I L V E R B Z N J I F P T C
N N S U P L Z I V T O H Z B E
W T D Q E D F V Q B V A C B T

DECORATE
GOD
GOLD
KING

LIVING
LORD
MAKER

NAILS
NAME
POWER

SILVER
SPEAK
TREE

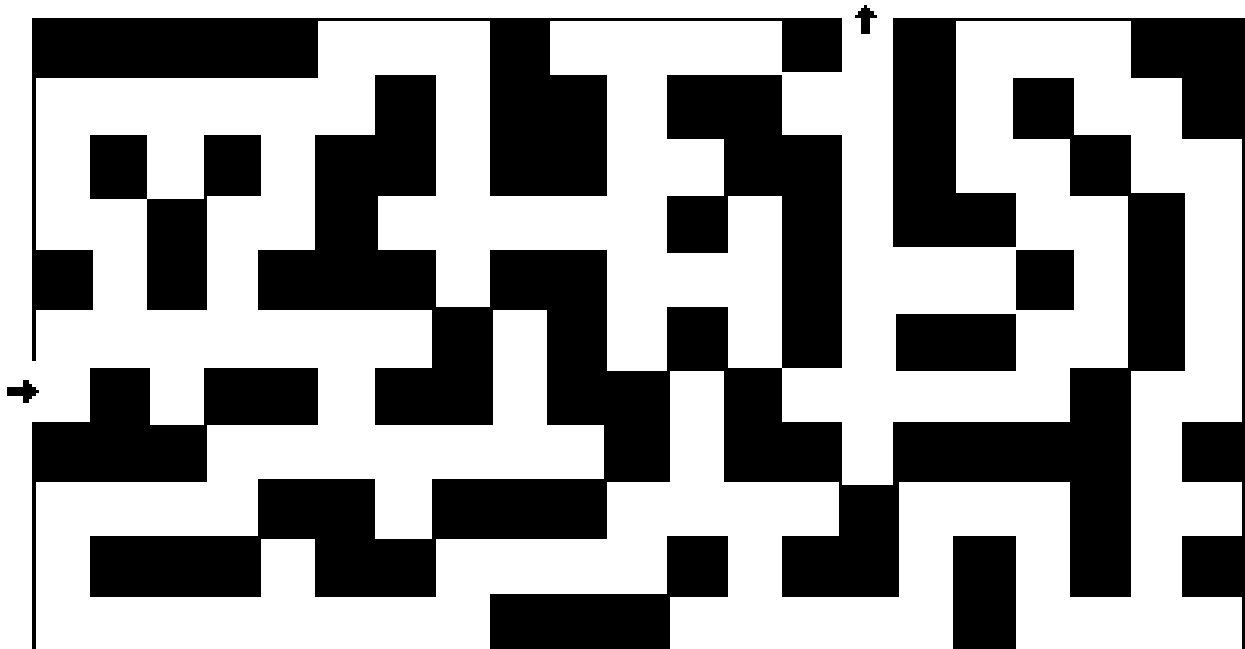

148. THE TRUE AND LIVING GOD

(JEREMIAH 10:1-16)

MEMORY VERSE:

"But the LORD is the true God; He is the living God and the everlasting King."
JEREMIAH 10:10

"Hear the word which the LORD speaks to you, O house of Israel. Thus says the LORD:..." JEREMIAH 10:1-2

CONCERNING THE PAGAN GODS:

FILL IN THE BLANK:

1. "For one cuts a _____ from the forest, the work of the hands of the workman, with the ax."
JEREMIAH 10:3

TRUE OR FALSE:

2. "They decorate it with copper and brass." JEREMIAH 10:4
TRUE OR FALSE
3. "They fasten it with nails and hammers so that it will not topple." JEREMIAH 10:4
TRUE OR FALSE

FILL IN THE BLANKS:

4. "They are upright, like a _____ tree." JEREMIAH 10:5
5. "They cannot _____; they must be _____ because they cannot go by themselves."
JEREMIAH 10:5

"But the LORD is the true God..."

6. "He is the _____ God and the _____." JEREMIAH 10:10
7. "He has made the earth by His _____." JEREMIAH 10:12
8. "For He is the _____ of all things." JEREMIAH 10:16

TRUE OR FALSE:

9. "The LORD of hosts is His name." JEREMIAH 10:16
TRUE OR FALSE

148. THE TRUE AND LIVING GOD

(JEREMIAH 10:1-16)

G E P P D V Q T Z A C X N Y S D C L I U
 M Y M R D C J N Z F B N K B I V V W R U
 B G B E Z A K D N T O P P L E B C W F A
 P M E X E L I A K F J A B B A G C Z Y D
 M R B U Z V C R E T K Y C E M A N O X D
 T Q O O R O E A O P S Q D P S L I A N W
 W H H S O T T R B Q S M W L G C H A D T
 N V S L W Z C Z L H M Q K I W R R K F L
 G V S G O D J E R A J T I V A E E U B A
 K G R K H M W M H E S H E I F V M N E O
 B L V W Q F Y D F A W T P N U L Q U H A
 Y S O V I D J W V U T O I G T I N D T P
 K N N R L M E Q I U A T P N O S Y L L A
 P B G J D Q T C G N I K R P G Z M U U D
 U K D X H S N X O T A T E Y M H A F W Y
 Y K P W T Q A I O R U R K F J K S L Q S
 F O K E Y D S T N T A R A O K K V Y N M
 K J S L L V L A H D E T M J G R Y H I U
 T Q P O J P P L I D N W E W H E K R S R
 G S G V A B U B U Q Q P I S G N W O V S

FIND THE WORDS FROM BELOW IN THE WORDSEARCH ABOVE

DECORATE
 EVERLASTING
 GOD
 GOLD

KING
 LIVING
 LORD
 MAKER

NAILS
 NAME
 POWER
 SILVER

SPEAK
 TOPPLE
 TREE
 TRUE

NOW UNSCRAMBLE THE WORDS FROM ABOVE AND WRITE THEM ON THE LINES BELOW

DRLO _____

ERTE _____

LEPOTP _____

AMNE _____

EPASK _____

RCTEDEOA _____

ODG _____

GKNI _____

VLEISR _____

KRMEA _____

LOGD _____

SRGNVEETLIA _____

ISALN _____

ETUR _____

VILGNI _____

RPEWO _____

148. THE TRUE AND LIVING GOD

(JEREMIAH 10:1-16)

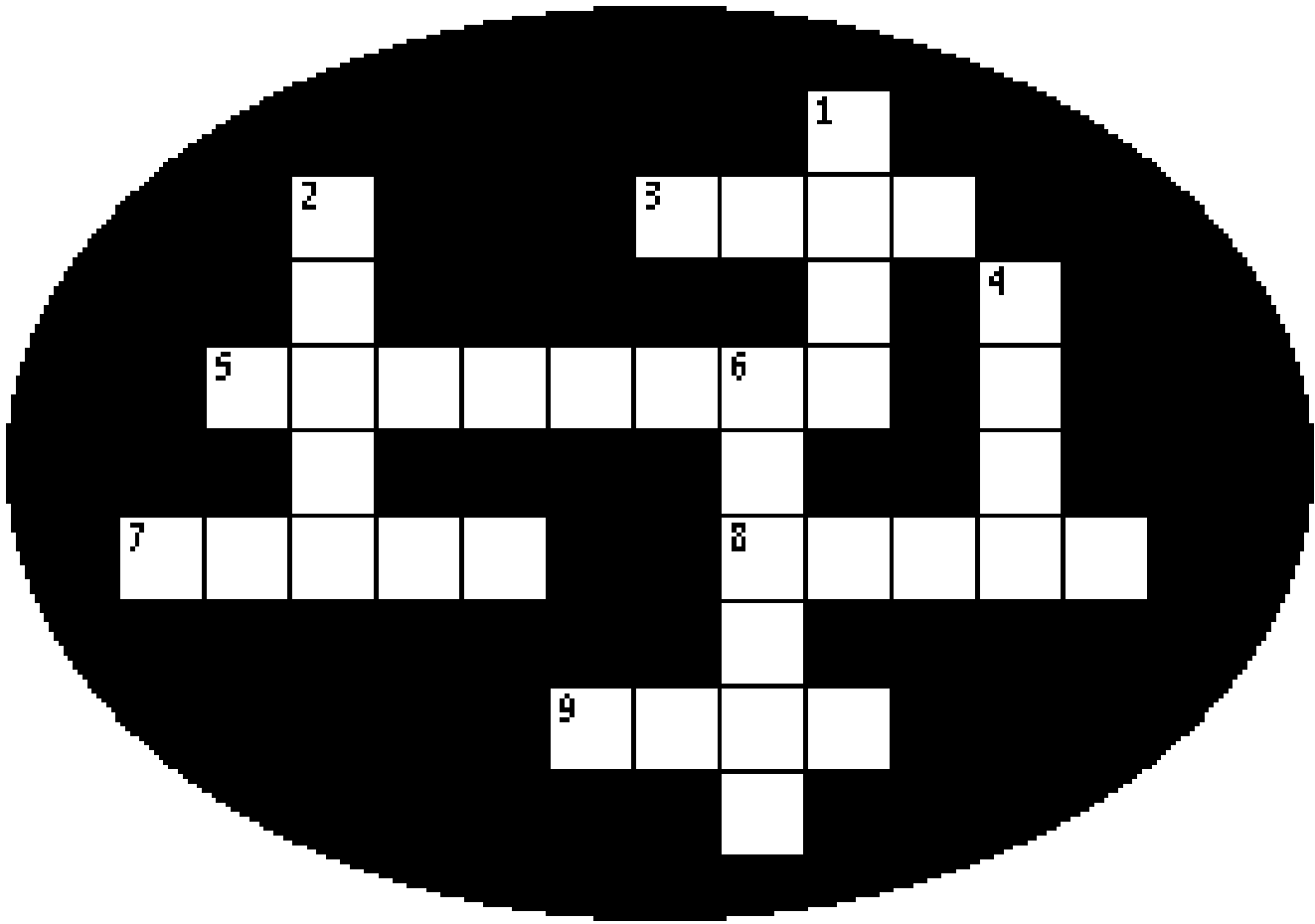

- 1 DOWN "For one cuts a _____ from the forest, the work of the hands of the workman, with the ax." **JEREMIAH 10:3**
- 5 ACROSS "They _____ it with silver and gold." **JEREMIAH 10:4**
- 6 DOWN "They fasten it with nails and hammers so that it will not _____." **JEREMIAH 10:4**
- 9 ACROSS "They are upright, like a _____ tree." **JEREMIAH 10:5**
- 2 DOWN "They cannot _____; they must be carried, because they cannot go by themselves." **JEREMIAH 10:5**
- 3 ACROSS "But the _____ is the true God; He is the living God and the everlasting King." **JEREMIAH 10:10**
- 8 ACROSS "He has made the earth by His _____." **JEREMIAH 10:12**
- 7 ACROSS "For He is the _____ of all things." **JEREMIAH 10:16**
- 4 DOWN "The LORD of hosts is His _____." **JEREMIAH 10:16**

Bible Story 149

**CLAY IN THE
POTTER'S HAND**

JEREMIAH 18:1-11

149. CLAY IN THE POTTER'S HAND (JEREMIAH 18:1-11)



"And the vessel that he made of clay was marred in the hand of the potter: so he made it again another vessel, as seemed good to the potter to make *it*." **JEREMIAH 18:4**

"O house of Israel, cannot I do with you as this potter? saith the LORD. Behold, as the clay *is* in the potter's hand, so *are* ye in mine hand, O house of Israel." **JEREMIAH 18:6**

149. CLAY IN THE POTTER'S HAND

(JEREMIAH 18:1-11)

MEMORY VERSE:

"As the clay is in the potter's hand, so you are in My hand." JEREMIAH 18:6

"The word which came to Jeremiah from the LORD, saying..."

CIRCLE THE CORRECT WORDS:

1. "Arise and go down to the (**POTTER'S, PUTTER'S**) house, and there I will cause you to hear My words." JEREMIAH 18:2
2. "Then I went down to the potter's house, and there he was, (**BREAKING, MAKING**) something at the wheel." JEREMIAH 18:3
3. "And the vessel that he made of (**CLAY, HAY**) was (**PERFECT, MARRED**) in the hand of the potter." JEREMIAH 18:4

TRUE OR FALSE:

4. "So he made it again into another vessel, as it seemed good to the potter to make." JEREMIAH 18:4

TRUE OR FALSE

5. The LORD asked, "O house of Israel, can I not do with you as this potter?" JEREMIAH 18:6

TRUE OR FALSE

CIRCLE THE CORRECT WORDS:

6. Then He said, "Look, as the clay is in the potter's (**EYES, HAND**), so you are in My (**SIGHT, HAND**) O house of Israel!" JEREMIAH 18:6

TRUE OR FALSE:

7. The LORD said, "If that nation against whom I have spoken turns from its evil, I will relent of the disaster that I thought to bring upon it." JEREMIAH 18:8

TRUE OR FALSE

CIRCLE THE CORRECT WORD:

8. But He said, "If it does evil in My sight so that it does not (**OBEY, HEAR**) My voice, then I will relent concerning the good with which I said I would benefit it." JEREMIAH 18:10

149. CLAY IN THE POTTER'S HAND

(JEREMIAH 18:1-11)

L O R R W L P E W M B R U F T
O T D X Q S U E P U S I H B K
M D N N Z H E H U M W S F P R
N Q A U M S H M K H F F C G M
P C H I X M L E S S E V W Q Y
V I W J H S Y Z K R W Z N F V
J A S C J D Z K H U H R L V A
I S J S Y R N I N W E C G K C
H H E J V O J R L O E C L A Y
D Y R R Z W V J A W L O T H C
Y T E E P L L G R X H R N M W
N J M T I N M H O U D F E U W
H V I T J J I B E D R V L D U
Y M A O L E C I O V H T E G X
Y A H P N H T W P M A R R E D

CLAY

POTTER

VOICE

HAND

RELENT

WHEEL

JEREMIAH

VESSEL

WORDS

MARRED

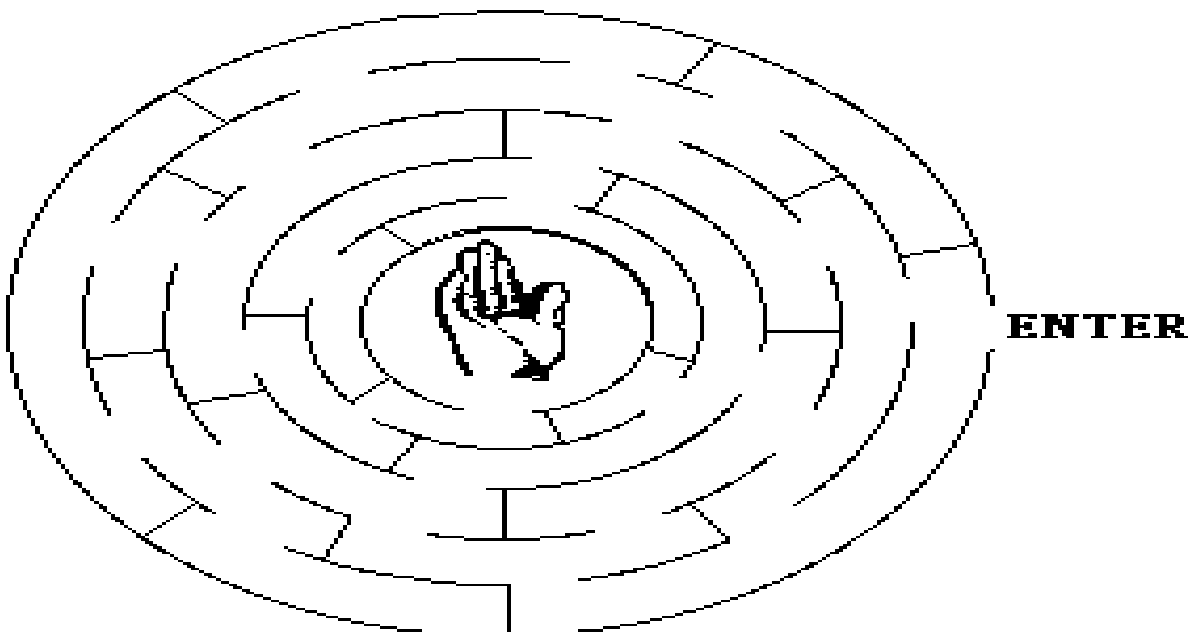

149. CLAY IN THE POTTER'S HAND

(JEREMIAH 18:1-11)

MEMORY VERSE:

"As the clay is in the potter's hand, so you are in My hand." JEREMIAH 18:6

"The word which came to Jeremiah from the LORD, saying..."

FILL IN THE BLANKS:

1. "Arise and go down to the _____ house, and there I will cause you to hear My words."
JEREMIAH 18:2
2. "Then I went down to the potter's house, and there he was, _____ something at the wheel."
JEREMIAH 18:3

CIRCLE THE CORRECT WORDS:

3. "And the vessel that he made of (**CLAY, HAY**) was (**PERFECT, MARRED**) in the hand of the potter."
JEREMIAH 18:4
4. "So he made it again into another (**BLOB, VESSEL**), as it seemed good to the potter to make."
JEREMIAH 18:4

TRUE OR FALSE:

5. The LORD asked, "O house of Israel, can I not do with you as this potter?"
JEREMIAH 18:6
TRUE OR FALSE

FILL IN THE BLANKS:

6. Then He said, "Look, as the clay is in the potter's _____, so you are in My _____, O house of Israel!"
JEREMIAH 18:6

TRUE OR FALSE:

7. The LORD said, "If that nation against whom I have spoken turns from its evil, I will relent of the disaster that I thought to bring upon it."
JEREMIAH 18:8
TRUE OR FALSE

FILL IN THE BLANK:

8. But He said, "If it does evil in My sight so that it does not _____ My voice, then I will relent concerning the good with which I said I would benefit it."
JEREMIAH 18:10

149. CLAY IN THE POTTER'S HAND (JEREMIAH 18:1-11)

R S D T A S H Z S S M L K S I Z T Q Z T
 U C M C A D W Q D B K K R R H A H P J R
 N K A C W H D Y E I T I V Q H D S A H H
 L Y R P F C H H D P B B U H R S D B F G
 T N R K C V O I C E D A A B P D L P H J
 C V E J Q N M Q R R B I P C Z Z B S A H
 A M D V S R J S S C M R F T J W U T N D
 N A O C D F R E N E N S M C F G H Y D H
 R Y M Y R D C N R E L G A N J Z Q L R P
 X Q E Q O M Q E J U V T Q L W Y O V K N
 C Z M O W O J R G L V T P O L E S S E V
 D I I L Y Z F F W W F W N Z Q T J O Y W
 W D Q T G E B Y K N W H P E U R N C S Q
 W P J Y Y W M P H T G K U R L L G T S A
 F T W V I L C A P E L L E Y J E A Z D V
 A F E O E V E F K A C T C L N U R O E U
 O C J D S Q T Y J D T F W S E K E E H D
 Q D M U D O G N A O Z N D H N E S P A L
 V L S I E N I W P L W Q C R V U H J R Z
 D D T R W J T Q G E C Y V V J P E W O N

CLAY
 HAND
 JEREMIAH
 MARRED

POTTER
 RELENT
 VESSEL

VOICE
 WHEEL
 WORDS

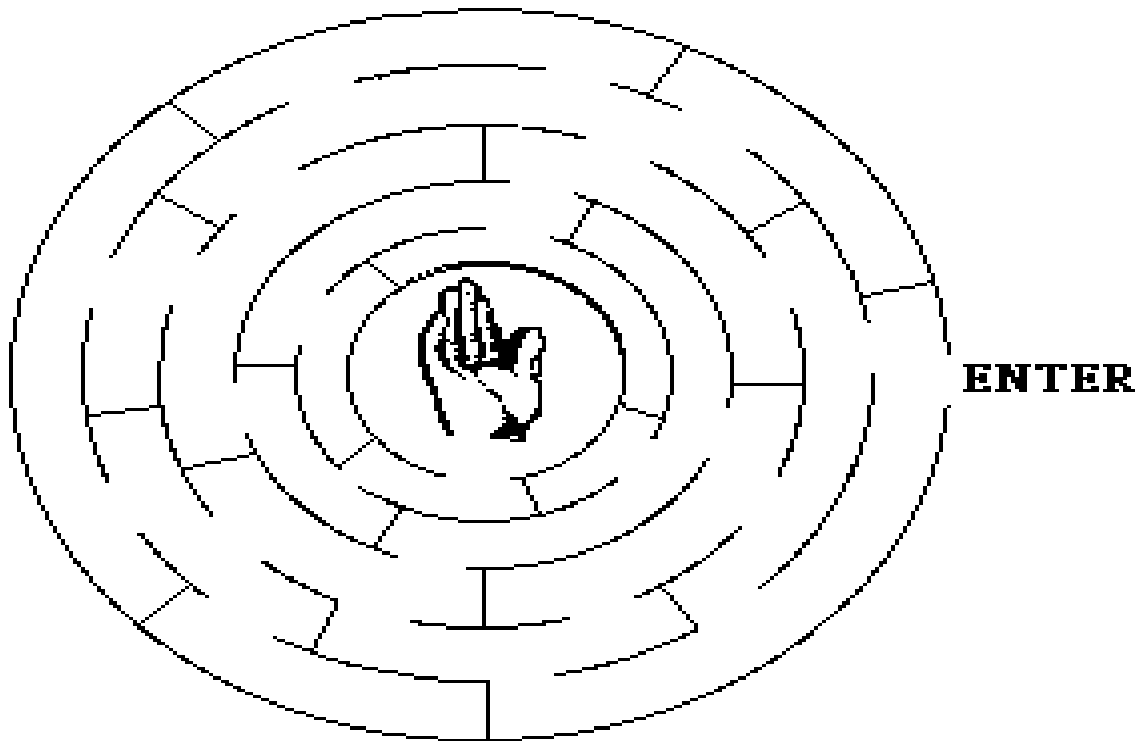

149. CLAY IN THE POTTER'S HAND (JEREMIAH 18:1-11)

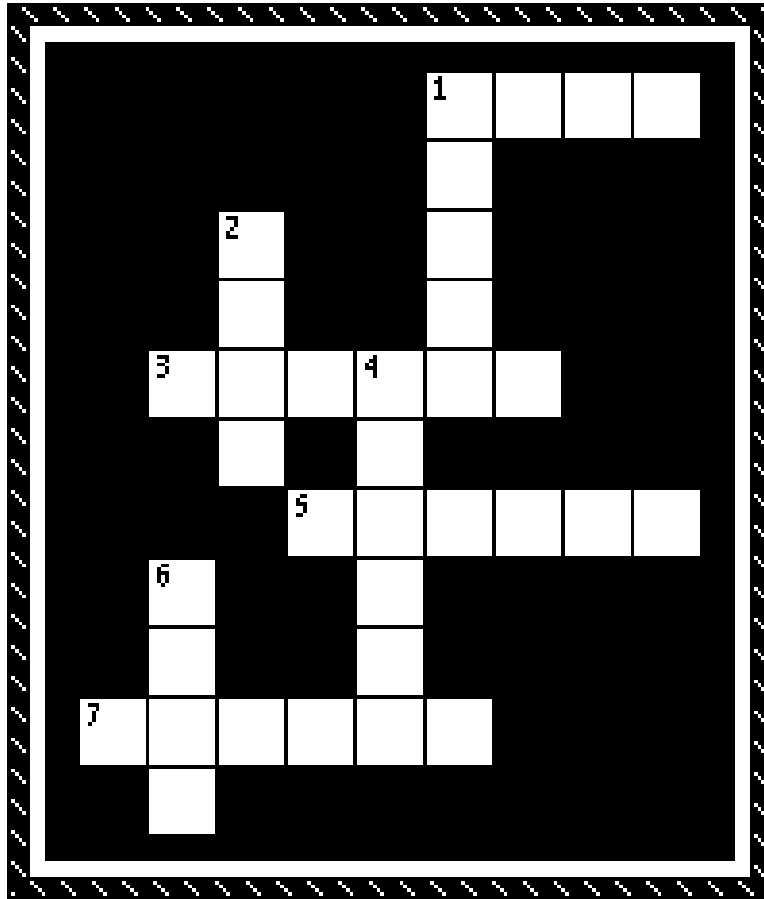

- 1 DOWN "Arise and go down to the potter's _____, and there I will cause you to hear My words." **JEREMIAH 18:2**
- 7 ACROSS "Then I went down to the potter's house, and there he was, _____ something at the wheel." **JEREMIAH 18:3**
- 6 DOWN "And the vessel that he made of _____ was marred in the hand of the potter." **JEREMIAH 18:4**
- 3 ACROSS "So he made it again into another _____, as it seemed good to the potter to make." **JEREMIAH 18:4**
- 5 ACROSS The LORD asked, "O house of Israel, can I not do with you as this _____?" **JEREMIAH 18:6**
- 1 ACROSS Then He said, "Look, as the clay is in the potter's _____, so you are in My hand, O house of Israel!" **JEREMIAH 18:6**
- 4 DOWN The LORD said, "If that nation against whom I have _____ turns from its evil, I will relent of the disaster that I thought to bring upon it." **JEREMIAH 18:8**
- 2 DOWN But He said, "If it does evil in My sight so that it does not _____ My voice, then I will relent concerning the good with which I said I would benefit it." **JEREMIAH 18:10**

Bible Story 150

JEREMIAH'S SCROLL

JEREMIAH 36:1-32

150. JEREMIAH'S SCROLL

(JEREMIAH 36:1-32)



"Therefore go thou, and read in the roll, which thou hast written from my mouth, the words of the LORD in the ears of the people in the LORD'S house upon the fasting day: and also thou shalt read them in the ears of all Judah that come out of their cities."

JEREMIAH 36:6

150. JEREMIAH'S SCROLL

(JEREMIAH 36:1-32)

MEMORY VERSE:

"It may be that the house of Judah will hear all the adversities which I propose to bring upon them, that everyone may turn from his evil way, that I may forgive their iniquity and their sin."
JEREMIAH 36:3

"Now it came to pass in the fourth year of Jehoiakim the son of Josiah, king of Judah, that this word came to Jeremiah from the LORD, saying:"

CIRCLE THE CORRECT WORDS:

1. "Take a (**COVER, SCROLL**) of a book and write on it all the words that I have spoken to you against Israel, against Judah, and against all the nations, from the day I spoke to you, from the days of Josiah even to this day." JEREMIAH 36:2
2. "And Jeremiah commanded Baruch, saying, 'I am (**CONFINED, FREE**), I cannot go into the house of the LORD.'" JEREMIAH 36:5
3. "You go, therefore, and read from the scroll which you have written at my instruction, the words of the LORD, in the hearing of the people in the LORD's (**HOUSE, LAND**) on the day of fasting." JEREMIAH 36:6

FILL IN THE BLANK:

4. "It may be that they will present their supplication before the LORD, and everyone will _____ from his evil way." JEREMIAH 36:7

TRUE OR FALSE:

5. But Baruch would not read from the book the words of Jeremiah in the house of the LORD. JEREMIAH 36:10
TRUE OR FALSE

CIRCLE THE CORRECT WORD:

6. The princes sent Jehudi to Baruch, saying, "Take in your hand the scroll from which you have (**COLORED, READ**) in the hearing of the people, and come." JEREMIAH 36:14

TRUE OR FALSE:

7. But Baruch would not read from the book the words of Jeremiah in their hearing. JEREMIAH 36:15
TRUE OR FALSE

CIRCLE THE CORRECT WORDS:

8. "Now it happened, when they had heard all the words, that they looked in fear from one to another, and said to Baruch, 'We will surely tell the (**KING, QUEEN**) of all these words.'" JEREMIAH 36:16
9. "When Jehudi had read three or four columns, that the king (**BUTTERED, CUT**) it with the scribe's knife and cast it into the fire that was on the hearth, until all the scroll was consumed in the fire that was on the hearth."
JEREMIAH 36:23

"Now after the king had burned the scroll with the words which Baruch had written at the instruction of Jeremiah, the word of the LORD came to Jeremiah, saying:"

TRUE OR FALSE:

10. "Take yet another scroll, and write on it all the former words that were in the first scroll which Jehoiakim the king of Judah has burned." JEREMIAH 36:28
TRUE OR FALSE

150. JEREMIAH'S SCROLL

(JEREMIAH 36:1-32)

C N K G N I K J T F D A
O E Q J R E Y I T W C N
N Q V E V L L O R C S R
F H A I M E R E J E B U
I D K S L N Y B V J K T
N L L U D R D P O O K P
E E S U O H S D R O L P
D K W E H C U R A B K A
U D N O I T A N R U A X
J E H O I A K I M G T V
E D K A Q E R I F F W Q
C O I D E N R U B K L D

BARUCH
BOOK
BURNED
CONFINED

CUT
EVIL
FIRE
JEHOIAKIM

JEREMIAH
KING
LORD'S HOUSE
NATION

READ
SCROLL
TURN

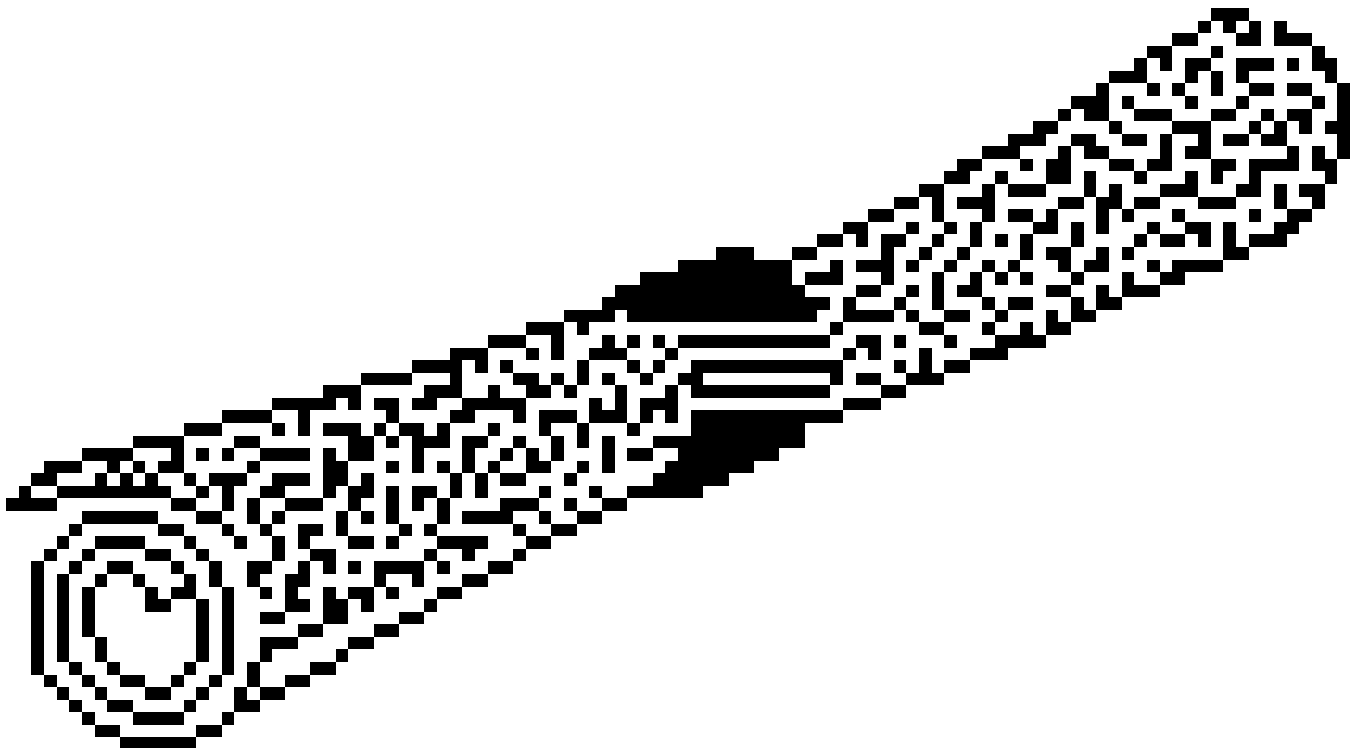

150. JEREMIAH'S SCROLL

(JEREMIAH 36:1-32)

MEMORY VERSE:

"It may be that the house of Judah will hear all the adversities which I propose to bring upon them, that everyone may turn from his evil way, that I may forgive their iniquity and their sin."
JEREMIAH 36:3

"Now it came to pass in the fourth year of Jehoiakim the son of Josiah, king of Judah, that this word came to Jeremiah from the LORD, saying:"

FILL IN THE BLANKS:

1. "Take a _____ of a book and write on it all the words that I have spoken to you against Israel, against Judah, and against all the nations, from the day I spoke to you, from the days of Josiah even to this day."
JEREMIAH 36:2
2. "And Jeremiah commanded Baruch, saying, 'I am _____, I cannot go into the house of the LORD.'
JEREMIAH 36:5
3. "You go, therefore, and read from the scroll which you have written at my instruction, the words of the LORD, in the hearing of the people in the _____ on the day of fasting." JEREMIAH 36:6
4. "It may be that they will present their supplication before the LORD, and everyone will _____ from his evil way." JEREMIAH 36:7

TRUE OR FALSE:

5. But Baruch would not read from the book the words of Jeremiah in the house of the LORD. JEREMIAH 36:10
TRUE OR FALSE

FILL IN THE BLANK:

6. The princes sent Jehudi to Baruch, saying, "Take in your hand the scroll from which you have _____ in the hearing of the people, and come." JEREMIAH 36:14

TRUE OR FALSE:

7. But Baruch would not read from the book the words of Jeremiah in their hearing. JEREMIAH 36:15
TRUE OR FALSE

FILL IN THE BLANK:

8. "Now it happened, when they had heard all the words, that they looked in fear from one to another, and said to Baruch, 'We will surely tell the _____ of all these words.'" JEREMIAH 36:16

CIRCLE THE CORRECT WORD:

9. "When Jehudi had read three or four columns, that the king (**BUTTERED**, **CUT**) it with the scribe's knife and cast it into the fire that was on the hearth, until all the scroll was consumed in the fire that was on the hearth."
JEREMIAH 36:23

"Now after the king had burned the scroll with the words which Baruch had written at the instruction of Jeremiah, the word of the LORD came to Jeremiah, saying:"

TRUE OR FALSE:

10. "Take yet another scroll, and write on it all the former words that were in the first scroll which Jehoiakim the king of Judah has burned." JEREMIAH 36:28

TRUE OR FALSE

150. JEREMIAH'S SCROLL

(JEREMIAH 36:1-32)

G V J T V A W B H T H E I B N K N B L S
 S N X Y P S Q H A A T P A G C W U E A P
 N G W K B L D F U S C R O L L L D H O T
 B D O O L P P E U A T I G C V W L T A W
 K O E A Q O I V N U R Y W D A E R L P B
 B P L V J U R I T R R B A Z N O I T A N
 K K V C I T T D T E U B F C W W U U A H
 O S D A C N A O S N W B N O C H F W D J
 J P D F I R E N D H P P T N H A L Q Y Y
 Q P Z L E D L H D Q O P O F R I Y N S K
 S B Z O T V B I Q R N U M I E M H I M P
 P R A Z C J I U C N K Y S N M E L S M G
 M X O R J R E L U A B F J E Q R O V J K
 B O W M U A Z H N R J T K D N E I U S G
 B S H F W C Z A O Y C O G H Y J R U E P
 O L Q M Y Z H F J I D J H K M Z F A J S
 H K I Q J T N B K Q A W G K A O Y D M O
 S W L S T E U T S U W K D R S A M D G T
 S K I N G M N C M Q K S I E V K D W O W
 R V H Q N D O Q J T I S V M Y N F T V I

BARUCH
 BOOK
 BURNED
 CONFINED

CUT
 EVIL
 FIRE
 JEHOIAKIM

JEREMIAH
 KING
 LORD'S HOUSE
 NATION

READ
 SCROLL
 TURN

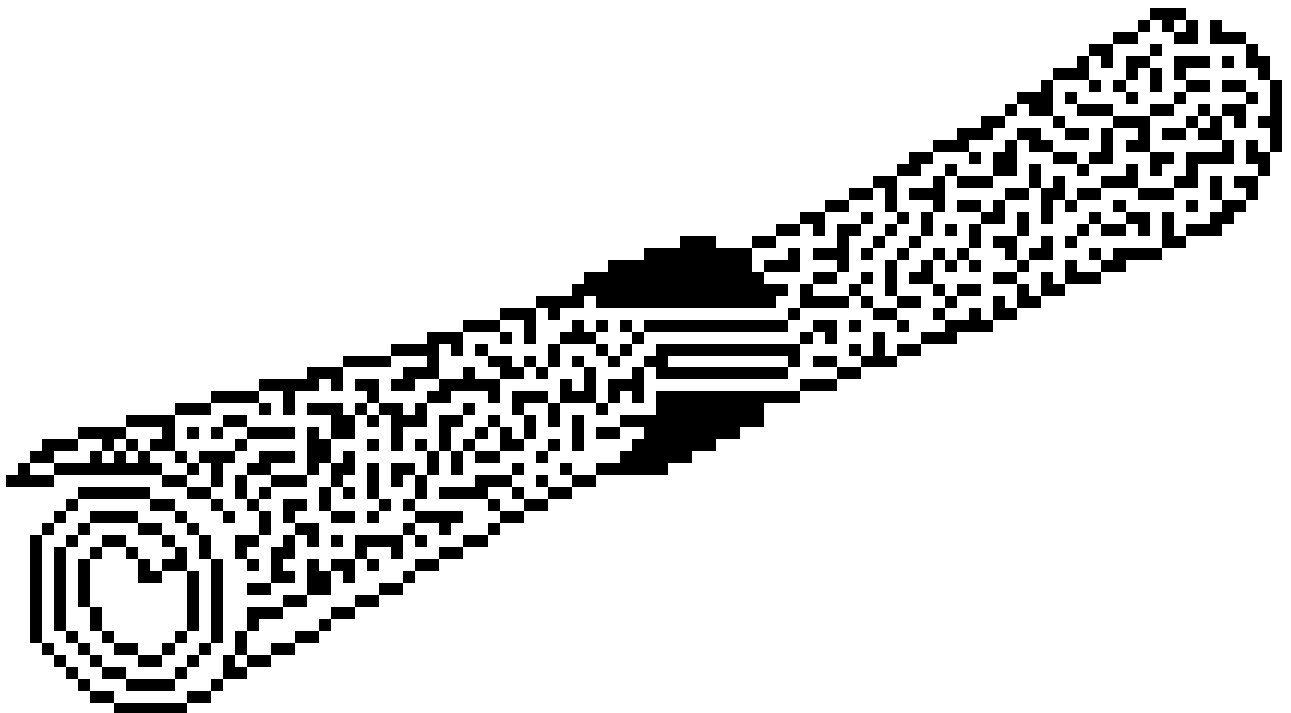

150. JEREMIAH'S SCROLL

(JEREMIAH 36:1-32)

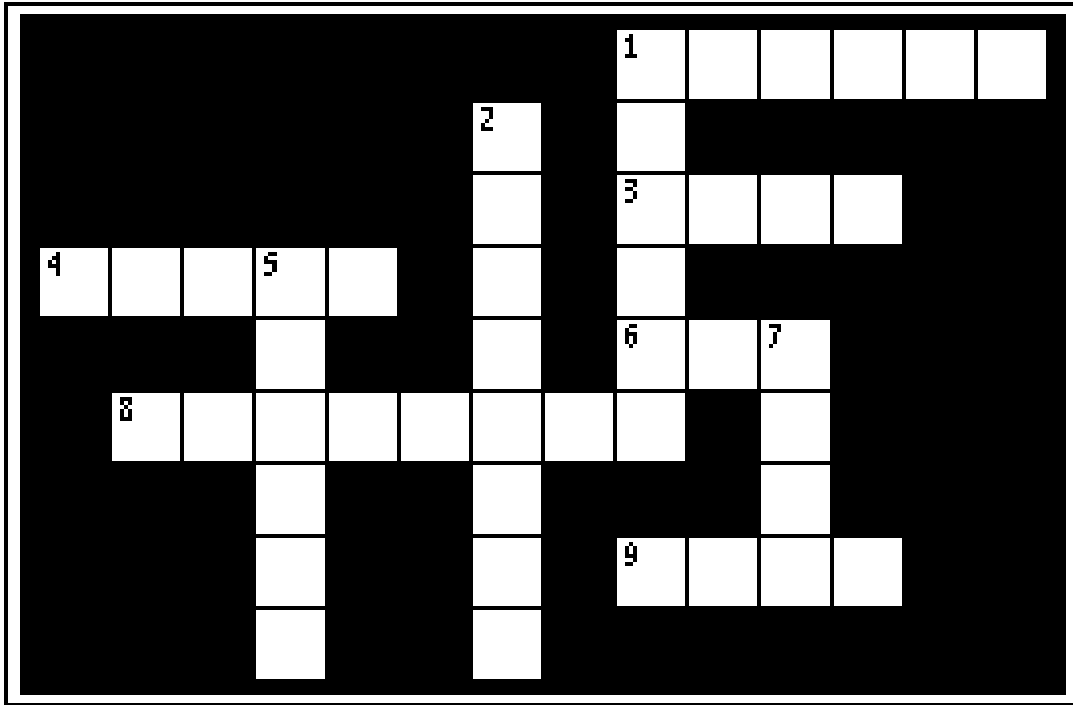

- 5 DOWN "Take a ____ of a book and write on it all the words that I have spoken to you against Israel, against Judah, and against all the nations, from the day I spoke to you, from the days of Josiah even to this day." **JEREMIAH 36:2**
- 2 DOWN "And Jeremiah commanded Baruch, saying, 'I am ____, I cannot go into the house of the LORD.'" **JEREMIAH 36:5**
- 4 ACROSS "You go, therefore, and read from the scroll which you have written at my instruction, the words of the LORD, in the hearing of the people in the LORD's ____ on the day of fasting." **JEREMIAH 36:6**
- 7 DOWN "It may be that they will present their supplication before the LORD, and everyone will ____ from his evil way." **JEREMIAH 36:7**
- 8 ACROSS "Then Baruch read from the book the words of ____ in the house of the LORD." **JEREMIAH 36:10**
- 3 ACROSS The princes sent Jehudi to Baruch, saying, "Take in your hand the scroll from which you have ____ in the hearing of the people, and come." **JEREMIAH 36:14**
- 1 DOWN "So ____ read it in their hearing." **JEREMIAH 36:15**
- 9 ACROSS "Now it happened, when they had heard all the words, that they looked in fear from one to another, and said to Baruch, 'We will surely tell the ____ of all these words.'" **JEREMIAH 36:16**
- 6 ACROSS "When Jehudi had read three or four columns, that the king ____ it with the scribe's knife and cast it into the fire that was on the hearth, until all the scroll was consumed in the fire that was on the hearth." **JEREMIAH 36:23**
- 1 ACROSS "Take yet another scroll, and write on it all the former words that were in the first scroll which Jehoiakim the king of Judah has ____." **JEREMIAH 36:28**

Bible Story 151

EZEKIEL'S CALL

EZEKIEL 2:1-3:15

151. EZEKIEL'S CALL

(EZEKIEL 2:1-3:15)



"And when I looked, behold, an hand *was* sent unto me; and, lo, a roll of a book *was* therein; And he spread it before me; and it *was* written within and without: and *there was* written therein lamentations, and mourning, and woe."

EZEKIEL 2:9-10

151. EZEKIEL'S CALL

(EZEKIEL 2:1-3:15)

MEMORY VERSE:

"Son of man, receive into your heart all My words that I speak to you, and hear with your ears."
EZEKIEL 3:10

CIRCLE THE CORRECT WORD:

1. The LORD said to Ezekiel, "Son of man, stand on your (**FEET, HEAD**), and I will speak to you." **EZEKIEL 2:1**

TRUE OR FALSE:

2. "Then the Spirit entered me when He spoke to me, and set me on my feet; and I heard Him who spoke to me."
EZEKIEL 2:2

TRUE OR FALSE

CIRCLE THE CORRECT WORDS:

3. "And He said to me: 'Son of man, I am sending you to the children of Israel, to a rebellious nation that has (**REBELLED, SPOKEN**) against Me." **EZEKIEL 2:3**
4. "Now when I looked, there was a hand stretched out to me; and behold, a (**COVER, SCROLL**) of a book was on it." **EZEKIEL 2:9**

TRUE OR FALSE:

5. "So I opened my mouth, and He caused me to eat that scroll." **EZEKIEL 3:2**

TRUE OR FALSE

CIRCLE THE CORRECT WORD:

6. "Moreover He said to me: 'Son of man, receive into your (**HEAD, HEART**) all My words that I speak to you, and hear with your ears.' " **EZEKIEL 3:10**

FILL IN THE BLANK:

7. Ezekiel said, "Then the Spirit lifted me up, and I heard behind me a great thunderous voice: 'Blessed is the _____ of the LORD from his place!' " **EZEKIEL 3:12**

CIRCLE THE CORRECT WORDS:

THE SAME WORD FITS IN ALL OF THESE SPACES. CIRCLE THAT WORD.

8. "I also heard the _____ of the wings of the living creatures that touched one another, and the _____ of the wheels beside them, and a great thunderous _____." **EZEKIEL 3:13**

SILENCE

NOISE

9. "So the Spirit lifted _____ up and took _____ away, and I went in bitterness, in the heat of my spirit; but the hand of the LORD was strong upon _____." **EZEKIEL 3:14**

ME

NO ONE

151. EZEKIEL'S CALL

(EZEKIEL 2:1-3:15)



EAT

HEART

REBELLED

EZEKIEL

LORD

SCROLL

FEET

MOUTH

SPIRIT

GLORY

NOISE

VOICE

WRITE DOWN THE LETTERS AS YOU COME TO THEM ON THE LINES BELOW



151. EZEKIEL'S CALL

(EZEKIEL 2:1-3:15)

MEMORY VERSE:

"Son of man, receive into your heart all My words that I speak to you, and hear with your ears."
EZEKIEL 3:10

FILL IN THE BLANK:

1. The LORD said to Ezekiel, "Son of man, stand on your _____, and I will speak to you." **EZEKIEL 2:1**

TRUE OR FALSE:

2. "Then the Spirit entered me when He spoke to me, and set me on my feet; and I heard Him who spoke to me."
EZEKIEL 2:2

TRUE OR FALSE

FILL IN THE BLANKS:

3. "And He said to me: 'Son of man, I am sending you to the children of Israel, to a rebellious nation that has _____ against Me.'" **EZEKIEL 2:3**
4. "Now when I looked, there was a hand stretched out to me; and behold, a _____ of a book was on it."
EZEKIEL 2:9

TRUE OR FALSE:

5. "So I opened my mouth, and He caused me to eat that scroll." **EZEKIEL 3:2**

TRUE OR FALSE

FILL IN THE BLANKS:

6. "Moreover He said to me: 'Son of man, receive into your _____ all My words that I speak to you, and hear with your ears.'" **EZEKIEL 3:10**
7. Ezekiel said, "Then the Spirit lifted me up, and I heard behind me a great thunderous voice: 'Blessed is the _____ of the LORD from his place!'" **EZEKIEL 3:12**

CIRCLE THE CORRECT WORDS:

THE SAME WORD FITS IN ALL OF THESE SPACES. CIRCLE THAT WORD.

8. "I also heard the _____ of the wings of the living creatures that touched one another, and the _____ of the wheels beside them, and a great thunderous _____." **EZEKIEL 3:13**

SILENCE

NOISE

9. "So the Spirit lifted _____ up and took _____ away, and I went in bitterness, in the heat of my spirit; but the hand of the LORD was strong upon _____." **EZEKIEL 3:14**

ME

NO ONE

FILL IN THE BLANKS:

10. "Then I came to the captives at _____, who dwelt by the River Chebar; and I sat where they sat, and remained there astonished among them seven days." **EZEKIEL 3:15**

151. EZEKIEL'S CALL

(EZEKIEL 2:1-3:15)



EAT
EZEKIEL
FEET
GLORY
HEART

LORD
MOUTH
NOISE
REBELLED

SCROLL
SPIRIT
STRONG
VOICE

WRITE DOWN THE LETTERS AS YOU COME TO THEM ON THE LINES BELOW

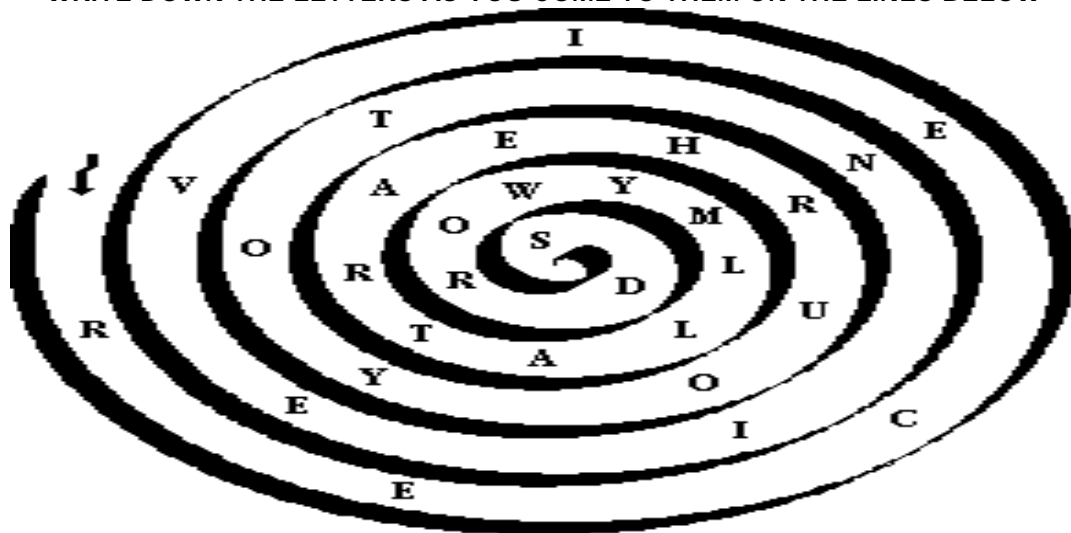

151. EZEKIEL'S CALL

(EZEKIEL 2:1-3:15)

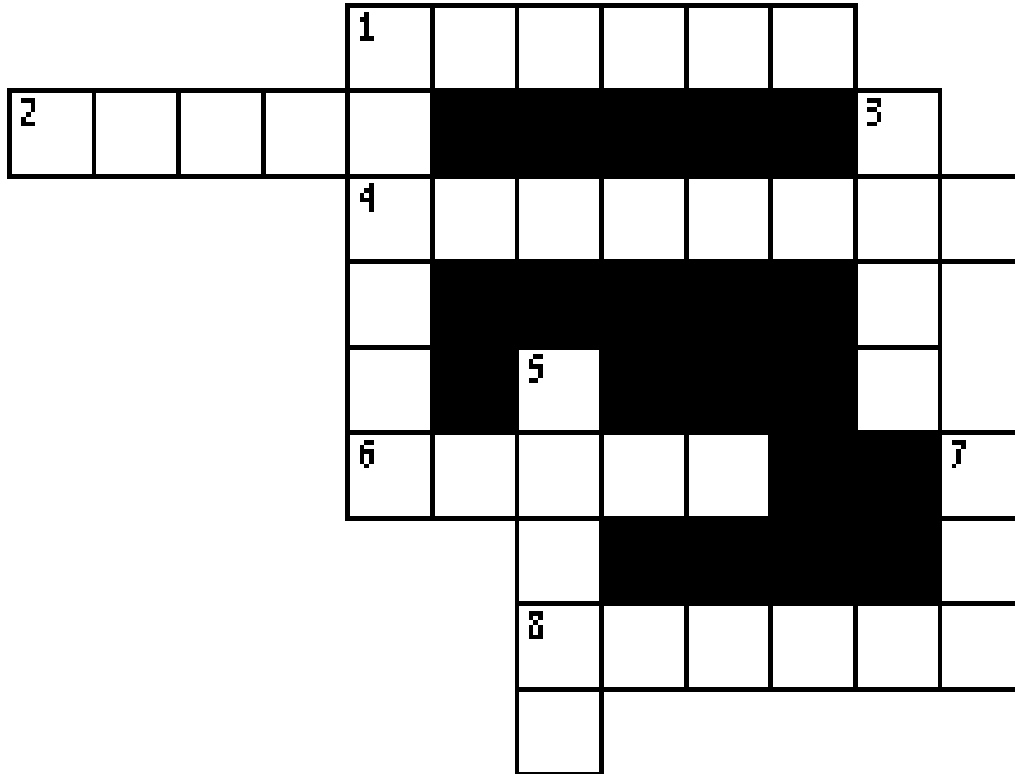

- 3 DOWN The LORD said to Ezekiel, "Son of man, stand on your _____, and I will speak to you." **EZEKIEL 2:1**
- 8 ACROSS "Then the _____ entered me when He spoke to me, and set me on my feet; and I heard Him who spoke to me." **EZEKIEL 2:2**
- 4 ACROSS "And He said to me: 'Son of man, I am sending you to the children of Israel, to a rebellious nation that has _____ against Me.'" **EZEKIEL 2:3**
- 1 ACROSS "Now when I looked, there was a hand stretched out to me; and behold, a _____ of a book was on it." **EZEKIEL 2:9**
- 7 DOWN "So I opened my mouth, and He caused me to _____ that scroll." **EZEKIEL 3:2**
- 2 ACROSS "Moreover He said to me: 'Son of man, receive into your _____ all My words that I speak to you, and hear with your ears.'" **EZEKIEL 3:10**
- 6 ACROSS Ezekiel said, "Then the Spirit lifted me up, and I heard behind me a great thunderous voice: 'Blessed is the _____ of the LORD from his place!' " **EZEKIEL 3:12**
- 5 DOWN "I also heard the _____ of the wings of the living creatures that touched one another, and the noise of the wheels beside them, and a great thunderous noise." **EZEKIEL 3:13**
- 1 DOWN "So the Spirit lifted me up and took me away, and I went in bitterness, in the heat of my spirit; but the hand of the LORD was _____ upon me." **EZEKIEL 3:14**

Bible Story 152

**GOD,
THE TRUE
SHEPHERD**

EZEKIEL 34:11-31

152. GOD, THE TRUE SHEPHERD
(EZEKIEL 34:11-31)



"For thus saith the Lord GOD; Behold, I, *even* I, will both search my sheep, and seek them out."
EZEKIEL 34:11

152. GOD, THE TRUE SHEPHERD (EZEKIEL 34:11-31)

MEMORY VERSE:

"You are My flock, the flock of My pasture." EZEKIEL 34:31

"For thus says the Lord GOD:"

CIRCLE THE CORRECT WORDS:

1. "Indeed I Myself will (**SEARCH, LISTEN**) for My sheep and seek them out." EZEKIEL 34:11
2. "As a (**SOLDIER, SHEPHERD**) seeks out his flock on the day he is among his scattered sheep, so I will seek out My sheep and deliver them from all the places where they were scattered on a cloudy and dark day." EZEKIEL 34:12
3. "And I will bring them out from the peoples and gather them from the countries, and will bring them to their (**NEIGHBOR'S, OWN**) land." EZEKIEL 34:13
4. "I will (**FORGET, SEEK**) what was lost and bring back what was driven away, bind up the broken and strengthen what was sick." EZEKIEL 34:16

TRUE OR FALSE:

5. The Lord GOD also said, "I will save My flock, and they shall no longer be a prey; and I will judge between sheep and sheep." EZEKIEL 34:22

TRUE OR FALSE

6. He said, "And I, the LORD, will be their God, and My servant David a prince among them; I, the LORD, have spoken." EZEKIEL 34:24

TRUE OR FALSE

CIRCLE THE CORRECT WORDS:

7. "I will make them and the places all around My hill a blessing; and I will cause showers to come down in their season; there shall be (**SHOWERS, DROPS**) of blessing." EZEKIEL 34:26

TRUE OR FALSE:

8. Then the trees of the field shall wither and produce no fruit. EZEKIEL 34:27

TRUE OR FALSE

9. "They shall be safe in their land; and they shall know that I am the LORD." EZEKIEL 34:27

TRUE OR FALSE

FILL IN THE BLANKS:

10. "I will raise up for them a _____ of renown, and they shall no longer be consumed with hunger in the land, nor bear the shame of the Gentiles anymore." EZEKIEL 34:29
11. "Thus they shall _____ that I, the LORD their God, am with them, and that they, the house of Israel, are My people," says the Lord GOD." EZEKIEL 34:30

152. GOD, THE TRUE SHEPHERD

(EZEKIEL 34:11-31)

O	D	H	Z	P	C	S	R	I	B	F	D	K	A	B
S	D	T	D	E	I	S	H	O	W	E	R	S	Y	C
L	H	R	S	S	R	L	A	T	H	F	Q	S	Q	D
K	O	C	R	H	J	U	G	A	R	D	E	N	U	W
L	Z	A	R	B	E	P	T	A	F	T	C	M	Q	K
W	E	Y	M	A	W	P	Z	S	V	Q	G	J	T	I
L	Z	O	S	Q	E	U	H	L	A	H	N	T	H	E
V	O	A	F	E	Y	S	E	E	I	P	I	A	T	P
J	G	V	M	J	E	T	M	B	R	A	S	A	T	I
X	W	A	Q	I	J	K	D	S	O	D	S	U	R	Y
W	H	C	T	S	T	N	A	Z	N	U	E	E	R	B
E	Q	A	S	H	A	F	W	Z	H	U	L	N	W	B
L	I	L	Q	C	E	V	Q	N	I	T	B	Q	P	P
F	R	U	I	T	N	R	E	K	U	T	U	X	N	P
V	L	O	V	T	A	D	X	O	A	D	J	N	K	Y

BLESSING
FRUIT
GARDEN
GATHER

ISRAEL
LORD
PASTURE

SAFE
SAVE
SEARCH

SEEK
SHEPHERD
SHOWERS

WRITE DOWN THE LETTERS AS YOU COME TO THEM ON THE LINES BELOW

→	Y							L						
	U					F							K	
			O											
							Y					C		
	R	A							O					
				E		M								

" _____ "

152. GOD, THE TRUE SHEPHERD (EZEKIEL 34:11-31)

MEMORY VERSE:

"You are My flock, the flock of My pasture." EZEKIEL 34:31

"For thus says the Lord GOD:"

FILL IN THE BLANKS:

1. "Indeed I Myself will _____ for My sheep and seek them out." EZEKIEL 34:11
2. "As a _____ seeks out his flock on the day he is among his scattered sheep, so I will seek out My sheep and deliver them from all the places where they were scattered on a cloudy and dark day."
EZEKIEL 34:12

CIRCLE THE CORRECT WORD:

3. "And I will bring them out from the peoples and gather them from the countries, and will bring them to their (NEIGHBOR'S, OWN) land." EZEKIEL 34:13

TRUE OR FALSE:

4. "I will seek what was lost and bring back what was driven away, bind up the broken and strengthen what was sick." EZEKIEL 34:16

TRUE OR FALSE

5. The Lord GOD also said, "I will save My flock, and they shall no longer be a prey; and I will judge between sheep and sheep." EZEKIEL 34:22

TRUE OR FALSE

FILL IN THE BLANKS:

6. He said, "And I, the LORD, will be their _____, and My servant David a _____ among them; I, the LORD, have spoken." EZEKIEL 34:24
7. "I will make them and the places all around My hill a blessing; and I will cause showers to come down in their season; there shall be _____." EZEKIEL 34:26

TRUE OR FALSE:

8. Then the trees of the field shall wither and produce no fruit. EZEKIEL 34:27

TRUE OR FALSE

9. "They shall be safe in their land; and they shall know that I am the LORD." EZEKIEL 34:27

TRUE OR FALSE

FILL IN THE BLANKS:

10. "I will raise up for them a _____ of renown, and they shall no longer be consumed with hunger in the land, nor bear the shame of the Gentiles anymore." EZEKIEL 34:29
11. "Thus they shall _____ that I, the LORD their God, am with them, and that they, the house of Israel, are My people," says the Lord GOD." EZEKIEL 34:30

152. GOD, THE TRUE SHEPHERD

(EZEKIEL 34:11-31)

U E U Z J O H F U Y H I M R I P Z S Z S
 J Q S F T T B D B H S H O N Y S Z N H Y
 I H C R A E S F S Z S O N M H P E E E K
 N M A D O U V F O M V Y J E J S E E C K
 J Q F U L O G Y Q C Y P K H N P Q P K A
 Z M V Y Z W W O Z K N D L B M J H P M Y
 C J N G F L L O A U B R S S B G S A U P
 V O H P G P H F P K M E U H B Q Y G H M
 R E H T A G V J I P H H L O N B G K E B
 O B L E S S I N G A Q P I W A M I P C N
 T E A O L K Y M I I C E H E Q T T P K E
 R S B P B A A P Z K J H O R P I A E K D
 N A Z K S K K D L H J S B S W S H Q Q R
 Q M C E E W Y O P Y B V N C T R A N F A
 O O M V N T C G S Z V C T U R A Y Y S G
 M B A J J E V D E B G T R I R E E F A S
 M S O M O S B R I R F E N P U L N N K O
 O Z S S U B M O G T N J G H V R M D S K
 G W Q F W P F L F L O C K J O Y F Y O J
 R Z C I B V F E R F F B T J U M I G M B

- | | | | |
|----------|----------|--------|----------|
| BLESSING | GATHER | SAFE | SHEEP |
| FLOCK | ISRAEL | SAVE | SHEPHERD |
| FRUIT | LORD GOD | SEARCH | SHOWERS |
| GARDEN | PASTURE | SEEK | |

WRITE DOWN THE LETTERS AS YOU COME TO THEM ON THE LINES BELOW

→	Y							L				
	U					F						K
			O									
								Y				C
	R	A								O		
				E		M						

" _____ "

152. GOD, THE TRUE SHEPHERD

(EZEKIEL 34:11-31)

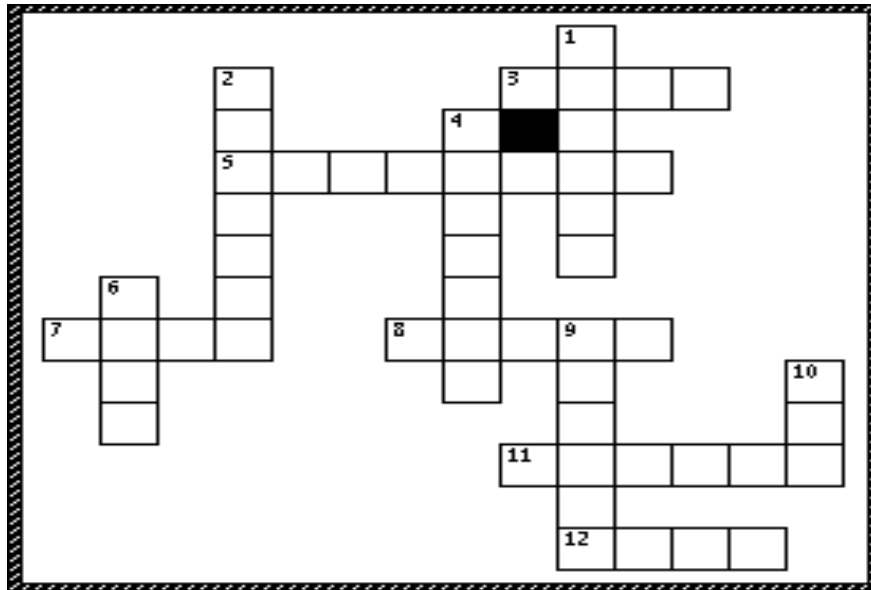

- 1 DOWN "Indeed I Myself will _____ for My sheep and seek them out." **EZEKIEL 34:11**
- 5 ACROSS "As a _____ seeks out his flock on the day he is among his scattered sheep, so I will seek out My sheep and deliver them from all the places where they were scattered on a cloudy and dark day." **EZEKIEL 34:12**
- 10 DOWN "And I will bring them out from the peoples and gather them from the countries, and will bring them to their _____ land." **EZEKIEL 34:13**
- 3 ACROSS "I will _____ what was lost and bring back what was driven away, bind up the broken and strengthen what was sick." **EZEKIEL 34:16**
- 6 DOWN The Lord GOD also said, "I will _____ My flock, and they shall no longer be a prey; and I will judge between sheep and sheep." **EZEKIEL 34:22**
- 12 ACROSS He said, "And I, the _____, will be their God, and My servant David a prince among them; I, the LORD, have spoken." **EZEKIEL 34:24**
- 4 DOWN "I will make them and the places all around My hill a blessing; and I will cause showers to come down in their season; there shall be _____ of blessing." **EZEKIEL 34:26**
- 8 ACROSS "Then the trees of the field shall yield their _____." **EZEKIEL 34:27**
- 7 ACROSS "They shall be _____ in their land; and they shall know that I am the LORD." **EZEKIEL 34:27**
- 11 ACROSS "I will raise up for them a _____ of renown, and they shall no longer be consumed with hunger in the land, nor bear the shame of the Gentiles anymore." **EZEKIEL 34:29**
- 9 DOWN "Thus they shall know that I, the LORD their God, am with them, and that they, the house of _____, are My people," says the Lord GOD." **EZEKIEL 34:30**
- 2 DOWN "You are My flock, the flock of My _____." **EZEKIEL 34:31**

Bible Story 153

A RENEWED HEART

EZEKIEL 36:26-27

153. A RENEWED HEART

(EZEKIEL 36:26-27)



"A new heart also will I give you, and a new spirit will I put within you: and I will take away the stony heart out of your flesh, and I will give you an heart of flesh."

EZEKIEL 36:26

153. A RENEWED HEART

(EZEKIEL 36:26-27)

MEMORY VERSE:

"I will give you a new heart and put a new spirit within you." EZEKIEL 36:26

"Thus says the Lord GOD: ..." EZEKIEL 36:22

CIRCLE THE CORRECT WORDS:

1. "I will give you a (NEW, COLD) heart and put a (NEW, OLD) spirit within you."
EZEKIEL 36:26

TRUE OR FALSE:

2. The Lord GOD also said, "I will take the heart of stone out of your flesh and give you a heart of flesh." EZEKIEL 36:26

TRUE OR FALSE

FILL IN THE BLANK:

3. Then the Lord GOD said, "I will put My _____ within you." EZEKIEL 36:27

CIRCLE THE CORRECT WORD:

4. He continued, "...and cause you to (WALK, FALL) in My statutes." EZEKIEL 36:27

TRUE OR FALSE:

5. Then He said, "But you will not keep My judgments nor will you do them."
EZEKIEL 36:27

TRUE OR FALSE

153. A RENEWED HEART

(EZEKIEL 36:26-27)

F Y F D B S I F D B Z E C N
U T W C R H B M Z D U Z A S
M E B V N U L T P V G C Z C
N E N O T S O E I S F L S N
V Z N S E S U T T R A E H P
S Q I O T Y P A Z N I E D C
L V H S W N T L V P Z P G B
B L T K G U E M U E Y H S C
M S I K T J W M K Y I S P M
I R W E L N C I G G F E C P
O S S L F A E E D D B L V R
N B Y D Z L W Z W N U F U E
K B L F A D P I E W L J I M
E Z N A N Y R I E Y A W P H

EZEKIEL

JUDGMENTS

STONE

FLESH

SPIRIT

WALK

HEART

STATUTES

WITHIN



153. A RENEWED HEART

(EZEKIEL 36:26-27)

MEMORY VERSE:

"I will give you a new heart and put a new spirit within you." EZEKIEL 36:26

"Thus says the Lord GOD: ..." EZEKIEL 36:22

FILL IN THE BLANKS:

1. "I will give you a _____ and put a _____ within you."
EZEKIEL 36:26

UNDERLINE THE CORRECT ANSWER:

2. The Lord GOD also said, "I will take the heart of stone out of your flesh and give you ..."
EZEKIEL 36:26
a. a heart of flesh
b. another heart of stone

FILL IN THE BLANK:

3. Then the Lord GOD said, "I will put My _____ within you." **EZEKIEL 36:27**

TRUE OR FALSE:

4. He continued, "...and cause you to walk in My statutes." **EZEKIEL 36:27**
TRUE OR FALSE
5. Then He said, "But you will not keep My judgments nor will you do them." **EZEKIEL 36:27**
TRUE OR FALSE

153. A RENEWED HEART

(EZEKIEL 36:26-27)

L S R X Y D G J M T D H G R B Q Z W O Q
 V O F H K T H Q G F F P I I X R R B V O
 N V W P Y N S X G Z H P C Y B K O V M T
 M Z T T T Y E Z T B G R N S U D J B G H
 J D P R P B Q P E C U B E E N O T S D K
 C C W Q A P M S L S Q N B Y L F L H E W
 M W V R S E B Q T S J G P D Y H L Z O W
 Y O G O J N H L E N V B U Y L L E C T L
 S P J N V U P T S L E L U B H K K O C L
 O O T C D L U A T S Q M R O I D L Y U R
 J R F B T T C I V N D L G E N I A K V Q
 I J G B A N R L P P W N L D K P W E N C
 M Y J T T I B L Z M D I J J N M A O V R
 O M S I P Z B M S N D B T B K J G J M H
 Y G W S Q H Y S M Q V Z Z H N W H S U N
 D U J F F R U O B Q V S F V I L G Z O N
 V U H A N A W A A H D V J G D N N N X V
 U O G W F A D L K V K M F W O G W W M G
 R V B T T J O K I Z N O E H F S B I G R
 S V A B H Y K N Y U S N O H M F L E S H

EZEKIEL

JUDGMENTS

STONE

FLESH

SPIRIT

WALK

HEART

STATUTES

WITHIN



153. A RENEWED HEART

(EZEKIEL 36:26-27)

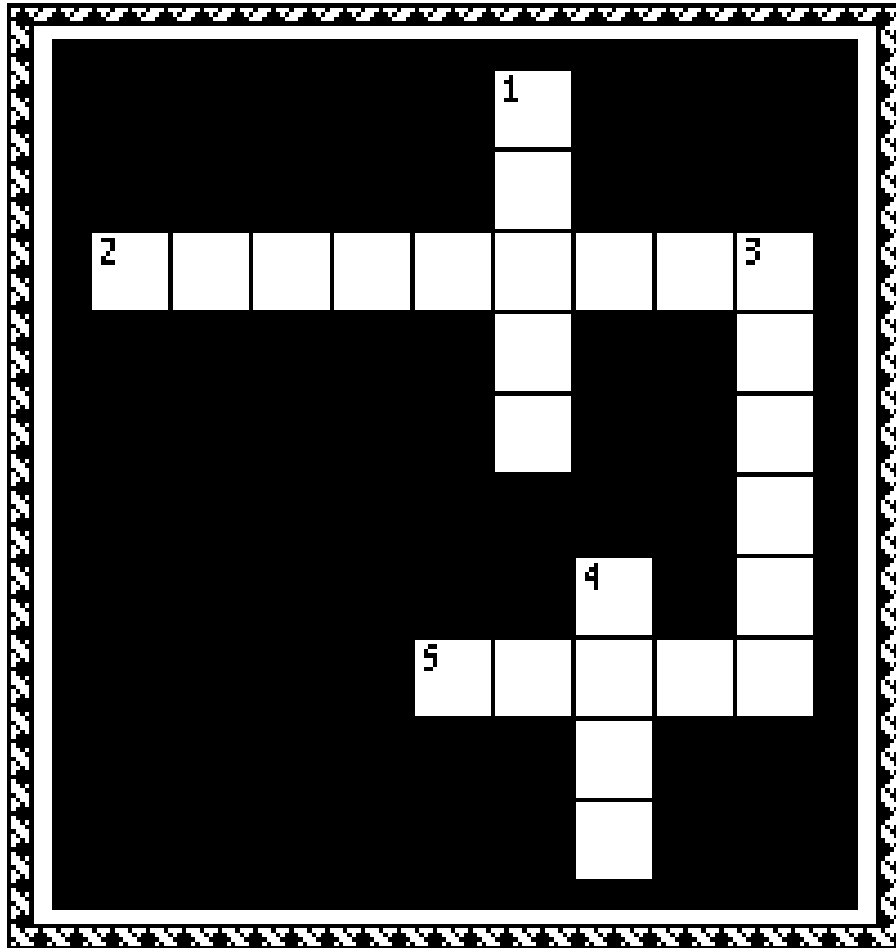

"Thus says the Lord GOD: ..." EZEKIEL 36:22

- 5 ACROSS "I will give you a new _____ and put a new spirit within you." **EZEKIEL 36:26**
- 1 DOWN The Lord GOD also said, "I will take the heart of stone out of your flesh and give you a heart of _____." **EZEKIEL 36:26**
- 3 DOWN Then the Lord GOD said, "I will put My _____ within you." **EZEKIEL 36:27**
- 4 DOWN He continued, "...and cause you to _____ in My statutes." **EZEKIEL 36:27**
- 2 ACROSS Then He said, "And you will keep My _____ and do them." **EZEKIEL 36:27**

Bible Story 154

**THE GLORY
RETURNS
TO THE TEMPLE**

EZEKIEL 43:1-12

154. THE GLORY RETURNS TO THE TEMPLE (EZEKIEL 43:1-12)



"So the spirit took me up, and brought me into the inner court;
and, behold, the glory of the LORD filled the house."

EZEKIEL 43:5

154. THE GLORY RETURNS TO THE TEMPLE

(EZEKIEL 43:1-12)

MEMORY VERSE:

"Son of man, this is the place of My throne and the place of the soles of My feet, where I will dwell in the midst of the children of Israel forever." EZEKIEL 43:7

CIRCLE THE CORRECT WORDS:

1. "Behold, the (**STORY**, **GLORY**) of the God of Israel came from the way of the east."
EZEKIEL 43:2
2. "His voice was like the sound of many (**WATERS**, **PEOPLE**)."
EZEKIEL 43:2
3. "The earth (**SHONE**, **SHOOK**) with His glory."
EZEKIEL 43:2

TRUE OR FALSE:

4. "And the glory of the LORD came into the temple by the way of the gate which faces toward the east."
EZEKIEL 43:4

TRUE OR FALSE

FILL IN THE BLANK:

5. "The Spirit lifted me up and brought me into the inner court; and behold, the glory of the LORD _____ the temple."
EZEKIEL 43:5

CIRCLE THE CORRECT WORD:

6. "And He said to me, 'Son of man, this is the place of My throne and the place of the soles of My feet, where I will dwell in the midst of the children of Israel (**FOR NOW**, **FOREVER**)."
EZEKIEL 43:7

FILL IN THE BLANK:

7. "This is the law of the temple: The whole area surrounding the mountaintop shall be most _____. Behold, this is the law of the temple."
EZEKIEL 43:12

154. THE GLORY RETURNS TO THE TEMPLE

(EZEKIEL 43:1-12)

G L O R Y D G F Q V
 D W E L L A A I T O
 L S R E T A W L I I
 A P F E G B T L R C
 W T H O L Y W E I E
 R E V E R O F D P N
 D E N O R H T P S O
 J V E O F K L A D H
 T E M P L E A N V S
 I R J U K K P V S M

DWELL	GLORY	SHONE	THRONE
FILLED	HOLY	SPIRIT	VOICE
FOREVER	LAW	TEMPLE	WATERS
GATE			

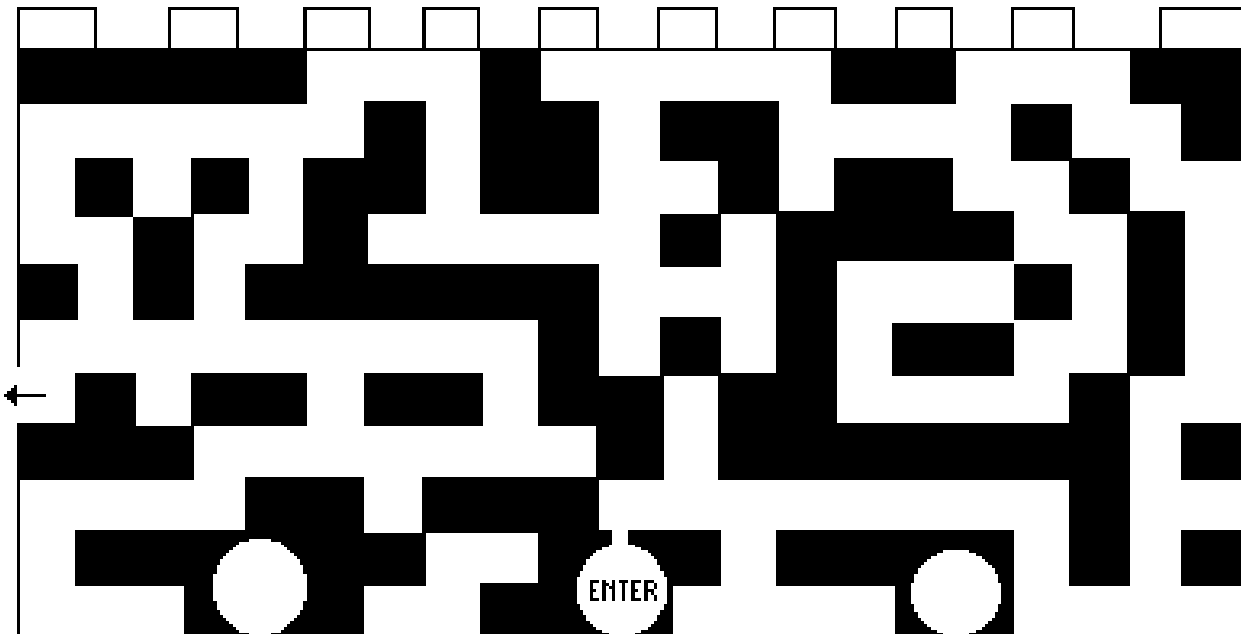

154. THE GLORY RETURNS TO THE TEMPLE

(EZEKIEL 43:1-12)

MEMORY VERSE:

"Son of man, this is the place of My throne and the place of the soles of My feet, where I will dwell in the midst of the children of Israel forever." EZEKIEL 43:7

FILL IN THE BLANKS:

1. "Behold, the _____ of the God of Israel came from the way of the east." **EZEKIEL 43:2**
2. "His voice was like the sound of many _____." **EZEKIEL 43:2**
3. "The earth _____ with His glory." **EZEKIEL 43:2**

TRUE OR FALSE:

4. "And the glory of the LORD came into the temple by the way of the gate which faces toward the east." **EZEKIEL 43:4**

TRUE OR FALSE

FILL IN THE BLANK:

5. "The Spirit lifted me up and brought me into the inner court; and behold, the glory of the LORD _____ the temple." **EZEKIEL 43:5**

UNDERLINE THE CORRECT ANSWER:

6. "And He said to me, 'Son of man, this is the place ...' " **EZEKIEL 43:7**
 - a. of My throne
 - b. of the soles of My feet
 - c. where I will dwell in the midst of the children of Israel forever
 - d. all of the above

FILL IN THE BLANK:

7. "This is the law of the temple: The whole area surrounding the mountaintop shall be most _____. Behold, this is the law of the temple." **EZEKIEL 43:12**

154. THE GLORY RETURNS TO THE TEMPLE

(EZEKIEL 43:1-12)

G K S P J Z L O B J R Q Z U Q
 E O S R E V S P I R I T Z A C
 Y E R F O N H Z Q T A X N F M
 G J N I O Z O M J N L L E W D
 M Q C O N R T R I A Z I K F J
 Q E V M H O E F H S W D O T K
 H S N L W S Y V C T A E B Q S
 V P G O A W O M E L T L H H M
 V G D S T W A Q T R E L F A J
 G M L L E E V S C P R I V U T
 S B P O L H M Q J U S F I U A
 N B K K R Q C P G T E T O T A
 B O S W V Y A A L N M A N T U
 H O L Y D I T V W E D L H D E
 K H P V D E L P Y D W B I D N

DWELL	GLORY	SHONE	THRONE
FILLED	HOLY	SPIRIT	VOICE
FOREVER	LAW	TEMPLE	WATERS
GATE			

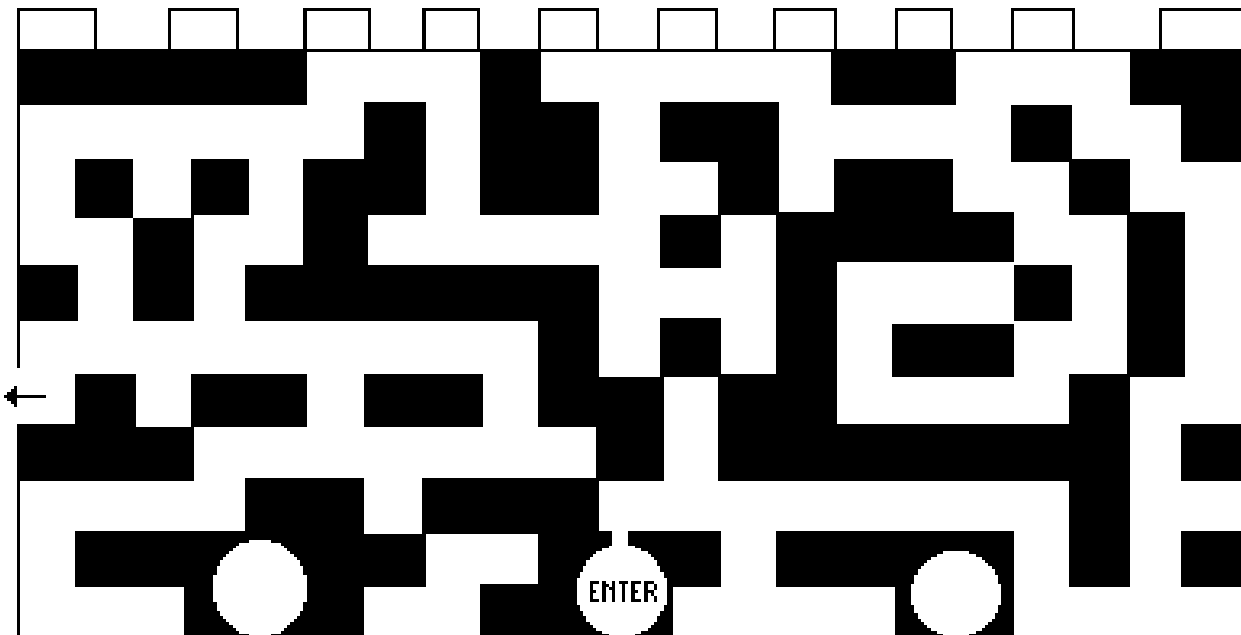

154. THE GLORY RETURNS TO THE TEMPLE

(EZEKIEL 43:1-12)

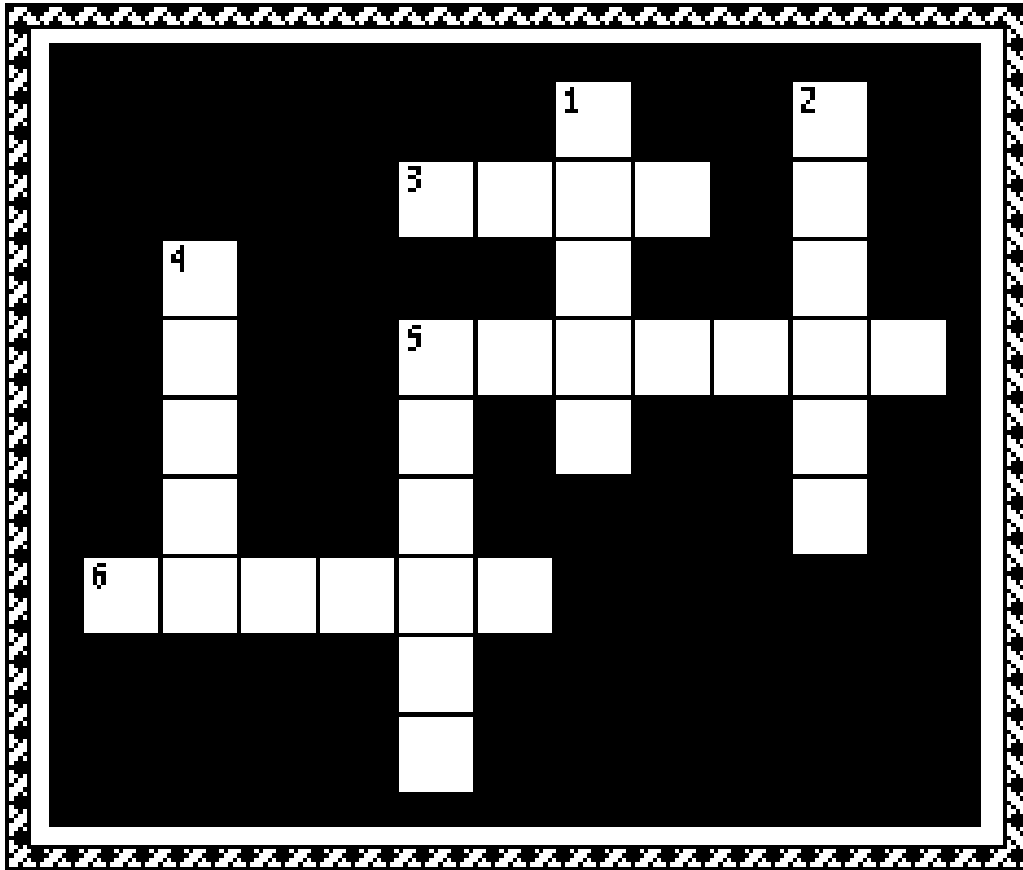

- 1 DOWN "Behold, the _____ of the God of Israel came from the way of the east." **EZEKIEL 43:2**
- 2 DOWN "His voice was like the sound of many _____." **EZEKIEL 43:2**
- 4 DOWN "The earth _____ with His glory." **EZEKIEL 43:2**
- 6 ACROSS "And the glory of the LORD came into the _____ by the way of the gate which faces toward the east." **EZEKIEL 43:4**
- 5 DOWN "The Spirit lifted me up and brought me into the inner court; and behold, the glory of the LORD _____ the temple." **EZEKIEL 43:5**
- 5 ACROSS "Son of man, this is the place of My throne and the place of the soles of My feet, where I will dwell in the midst of the children of Israel _____." **EZEKIEL 43:7**
- 3 ACROSS "This is the law of the temple: The whole area surrounding the mountaintop shall be most _____. Behold, this is the law of the temple." **EZEKIEL 43:12**

Bible Story 155

**DANIEL & HIS
FRIENDS OBEY GOD**

DANIEL 1:3-15

155. DANIEL AND HIS FRIENDS OBEY GOD

(DANIEL 1:1-17)



"Then said Daniel to Melzar, whom the prince of the eunuchs had set over Daniel, Hananiah, Mishael, and Azariah, prove the servants, I beseech thee, ten days; and let them give us vegetables to eat, and water to drink."

DANIEL 1:11-12

155. DANIEL AND HIS FRIENDS OBEY GOD

(DANIEL 1:1-17)

MEMORY VERSE:

"As for these four young men, God gave them knowledge and skill in all literature and wisdom."
DANIEL 1:17

"In the third year of the reign of Jehoiakim king of Judah, Nebuchadnezzar king of Babylon came to Jerusalem and besieged it." DANIEL 1:1

WRITE THE WORDS FROM BELOW IN THE CORRECT SPACES:

1. "Then the king instructed Ashpenaz, the master of his eunuchs, to bring some of the children of _____ and some of the king's _____ and some of the _____." DANIEL 1:3

DESCENDANTS

NOBLES

ISRAEL

TRUE OR FALSE:

2. "Now from among those of the sons of Judah were Daniel, Hananiah, Mishael, and Azariah." DANIEL 1:6
TRUE OR FALSE

MATCHING:

3. "To them the chief of the eunuchs gave names:" DANIEL 1:7
- | | | |
|-------|-------------------------|-----------------|
| _____ | he gave Daniel the name | a. Shadrach |
| _____ | to Hananiah | b. Abed-Nego |
| _____ | to Mishael | c. Belteshazzar |
| _____ | and to Azariah | d. Meshach |

CIRCLE THE CORRECT WORDS:

4. "Daniel purposed in his heart that he would not (**FILL, DEFILE**) himself with the portion of the king's delicacies, nor with the wine which he drank; therefore he requested of the chief of the eunuchs that he might not (**FILL, DEFILE**) himself." DANIEL 1:8

TRUE OR FALSE:

5. "Now God had brought Daniel into the favor and good will of the chief of the eunuchs." DANIEL 1:9
TRUE OR FALSE

CIRCLE THE CORRECT WORDS:

6. "Daniel said to the steward whom the chief of the eunuchs had set over Daniel, Hananiah, Mishael, and Azariah, 'Please (**TEST, REST**) your servants for ten days, and let them give us (**FRUITS, VEGETABLES**) to eat and (**WATER, SODA**) to drink.'" DANIEL 1:11-12

TRUE OR FALSE:

7. But he would not consent with them in this matter, and would not test them for ten days. DANIEL 1:14
TRUE OR FALSE
8. "And at the end of ten days their countenance appeared better and fatter in flesh than all the young men who ate the portion of the king's delicacies." DANIEL 1:15
TRUE OR FALSE

155. DANIEL AND HIS FRIENDS OBEY GOD (DANIEL 1:1-17)

S Q Z P F M O X W M G G F C C
H J Z I A A J P D W Y Z L U D
A B K Q Y Z J J W U P J L M O
D B C D Y S H C A H S E M D G
R R O G E N D E B A Y P M L W
A B T J O H E H Y F B N S S J
C K I Q F M A G P I D U Z V U
H E O R V L W G N I K O F R K
Q R A Z Z E N D A H C U B E N
I F T I N R E T A W R L P C O
W J E L I F E D Z B C E G M C
Z T A L S S L E W T G I K L H
V E G E T A B L E S R N B B I
K E N S V V Z U B E G A U R E
K J R T R O V A F T N D N A F

ABED-NEGO
CHIEF
DANIEL
DEFILE

FAVOR
GOD
KING

MESHACH
NEBUCHADNEZZAR
SHADRACH

TEST
VEGETABLES
WATER

DANIEL, SHADRACH, MESHACH AND ABED-NEGO ARE CARRIED AWAY TO BABYLON



155. DANIEL AND HIS FRIENDS OBEY GOD

(DANIEL 1:1-17)

MEMORY VERSE:

"As for these four young men, God gave them knowledge and skill in all literature and wisdom."

DANIEL 1:17

"In the third year of the reign of Jehoiakim king of Judah, Nebuchadnezzar king of Babylon came to Jerusalem and besieged it." DANIEL 1:1

TRUE OR FALSE:

1. "Then the king instructed Ashpenaz, the master of his eunuchs, to bring some of the children of Israel and some of the king's descendants and some of the nobles." **DANIEL 1:3**
TRUE OR FALSE
2. "Now from among those of the sons of Judah were Daniel, Hananiah, Mishael, and Azariah." **DANIEL 1:6**
TRUE OR FALSE

FILL IN THE BLANKS:

3. "To them the chief of the eunuchs gave names:" **DANIEL 1:7**
he gave Daniel the name _____
to Hananiah _____
to Mishael _____
and to Azariah _____
4. "Daniel purposed in his heart that he would not _____ himself with the portion of the king's delicacies, nor with the wine which he drank; therefore he requested of the chief of the eunuchs that he might not _____ himself." **DANIEL 1:8**

TRUE OR FALSE:

5. "Now God had brought Daniel into the favor and good will of the chief of the eunuchs." **DANIEL 1:9**
TRUE OR FALSE

FILL IN THE BLANKS:

6. "Daniel said to the steward whom the chief of the eunuchs had set over Daniel, Hananiah, Mishael, and Azariah, 'Please _____ your servants for ten days, and let them give us _____ to eat and _____ to drink.'" **DANIEL 1:11-12**

TRUE OR FALSE:

7. But he would not consent with them in this matter, and would not test them for ten days. **DANIEL 1:14**
TRUE OR FALSE
8. "And at the end of ten days their countenance appeared better and fatter in flesh than all the young men who ate the portion of the king's delicacies." **DANIEL 1:15**
TRUE OR FALSE

155. DANIEL AND HIS FRIENDS OBEY GOD (DANIEL 1:1-17)

B P V V J L Q H T K Q D J K E S D B D M
 K K D C I P P F Q S U W W G N V L E W G
 K S D A C U H W H V E G E T A B L E S O
 O P L L N T I C A M Q K S H C Y U H T V
 J P Z E T E T I A J T I S E L I F E D S
 Q R Z O I N B O U R H E I G W K F T L P
 S B O Z C N A U U T D P A D C W L L A T
 P O W M J D A N C A T A G V C L Y U O W
 M S H F C R L D O H T I H B H W H W A B
 B L Q M K H B H T G A T R S R W N Q P H
 B M I Q W I I I T A E D W E E Z O N A J
 O K E S Y A N E D U R N N G T O I I D Y
 H W L S J Z Z G F E R B D E M T R S Y K
 S V H Q H E Z U D N W B A E Z A E V S P
 S J T V D A N A Q Q P P F C B Z F B M G
 R B Y O T M C F C N N W M Z Q A A W T K
 V W G P N T B H W N A P T H N K Y R R G
 N E O B A D S F J T K Y O K Y U W U S P
 G F A V O R O E E A B F M K M N D A E S
 D L A Q S W B R T Y C O J R A U F D J O

ABED-NEGO
 BETTER
 CHIEF
 SHADRACH
 TEST

DEFILE
 FAVOR
 GOD
 WATER
 KING

MESHACH
 NEBUCHADNEZZAR
 VEGETABLES
 DANIEL

DANIEL, SHADRACH, MESHACH AND ABED-NEGO ARE CARRIED AWAY TO BABYLON



155. DANIEL AND HIS FRIENDS OBEY GOD

(DANIEL 1:1-17)

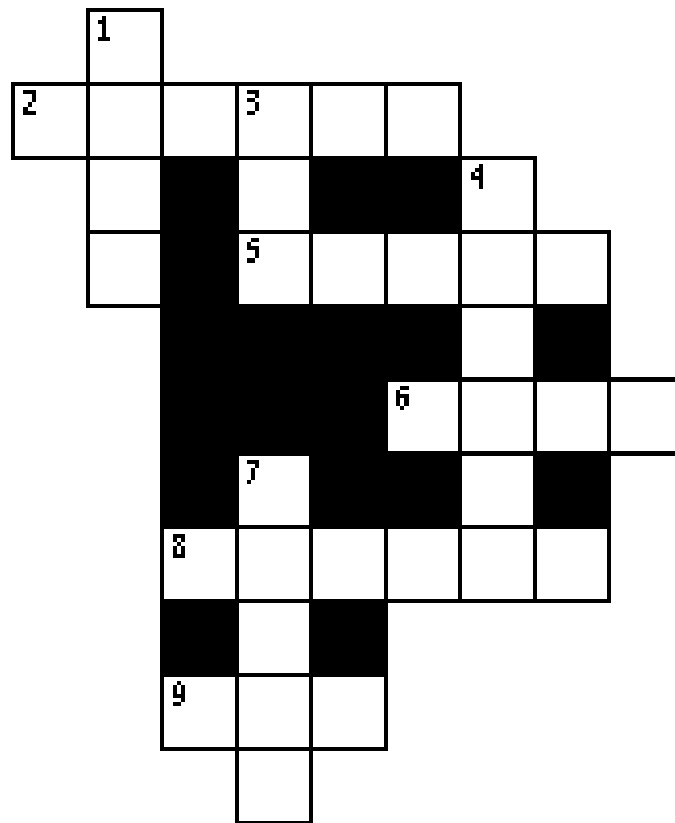

- 6 ACROSS "Then the _____ instructed Ashpenaz, the master of his eunuchs, to bring some of the children of Israel and some of the king's descendants and some of the nobles." **DANIEL 1:3**
- 8 ACROSS "Now from among those of the sons of Judah were _____, Hananiah, Mishael, and Azariah." **DANIEL 1:6**
- 5 ACROSS "To them the chief of the eunuchs gave _____." **DANIEL 1:7**
- 4 DOWN "Daniel purposed in his heart that he would not _____ himself with the portion of the king's delicacies, nor with the wine which he drank; therefore he requested of the chief of the eunuchs that he might not defile himself." **DANIEL 1:8**
- 7 DOWN "Now God had brought Daniel into the _____ and good will of the chief of the eunuchs." **DANIEL 1:9**
- 1 DOWN "Daniel said to the steward whom the chief of the eunuchs had set over Daniel, Hananiah, Mishael, and Azariah, 'Please _____ your servants for ten days, and let them give us vegetables to eat and water to drink.'" **DANIEL 1:11-12**
- 3 DOWN "So he consented with them in this matter, and tested them _____ days." **DANIEL 1:14**
- 2 ACROSS "And at the end of ten days their countenance appeared _____ and fatter in flesh than all the young men who ate the portion of the king's delicacies." **DANIEL 1:15**
- 9 ACROSS "As for these four young men, _____ gave them knowledge and skill in all literature and wisdom." **DANIEL 1:17**

Bible Story 156

**NEBUCHADNEZZAR'S
DREAM**

DANIEL 2:1-49

156. NEBUCHADNEZZAR'S DREAM

(DANIEL 2:1-49)



“Then Arioch brought in Daniel before the king in haste, and said thus unto him, I have found a man of the captives of Judah, that will make known unto the king the interpretation. The king answered and said to Daniel, whose name was Belteshazzar, Art thou able to make known unto me the dream which I have seen, and the interpretation thereof?”

DANIEL 2:25-26

156. NEBUCHADNEZZAR'S DREAM (DANIEL 2:1-49)

MEMORY VERSE:

"Truly your God is the God of gods, the Lord of kings, and a revealer of secrets." DANIEL 2:47

CIRCLE THE CORRECT WORD:

1. "Now in the second year of Nebuchadnezzar's reign, Nebuchadnezzar had (SCREAMS, DREAMS)."
DANIEL 2:1

TRUE OR FALSE:

2. "His spirit was so troubled that his sleep left him." DANIEL 2:1
TRUE OR FALSE

CIRCLE THE CORRECT WORDS:

3. "Then the king gave the command to call the ...
magicians clowns queen
astrologers sorcerers Chaldeans
to tell the king his dreams." DANIEL 2:2

TRUE OR FALSE:

4. The king said to them, "If you do not make known the dream to me, and its interpretation, you shall be cut in pieces, and your houses shall be made an ash heap." DANIEL 2:5
TRUE OR FALSE
5. The Chaldeans said to the king, "It is a difficult thing that the king requires, and there is no other who can tell it to the king except the gods, whose dwelling is not with flesh." DANIEL 2:11
TRUE OR FALSE
6. For this reason the king was very happy and joyful, and gave a command to celebrate the wisdom of the Chaldeans. DANIEL 2:12
TRUE OR FALSE

CIRCLE THE CORRECT WORDS:

7. "So the decree went out, and they began (KILLING, PRAISING) the wise men of Babylon." DANIEL 2:13
8. "Daniel went in and asked the king to give him (MONEY, TIME), that he might tell the king the interpretation." DANIEL 2:16
9. "Then Daniel went to his house, and made the decision known to Hananiah, Mishael, and Azariah, his companions, that they might seek mercies from the (GOD, CLOUDS) of heaven concerning this secret, so that Daniel and his companions might not perish with the rest of the wise men of Babylon." DANIEL 2:17-18

TRUE OR FALSE:

10. But the secret was not revealed to Daniel or to his companions. DANIEL 2:19
TRUE OR FALSE

CIRCLE THE CORRECT WORD:

11. Daniel was brought before the king and said, "There is a God in heaven who reveals secrets, and He has made known to King Nebuchadnezzar what will be in the (EARLY, LATTER) days." DANIEL 2:28

156. NEBUCHADNEZZAR'S DREAM

(DANIEL 2:1-49)

A R K Z H D Q S H B A C D U P
S C O Y E C O W Q K R S D E N
H M I C Z V A U O S L C O A O
H L R Y Y T Y O R T S E D V I
E E D N A M M O C U W H K D S
A B T O N W W D E H J U Q Q I
P B E J J H S L E E P E K E V
C A J F T P V L E I N A D N T
U R A Z Z E N D A H C U B E N
M C K A P S E I C R E M L R V
D W N E M E S I W P U C W Y R
L G O D L J M S W E O N K Y F
L A T T E R D A Y S E Q I D E
S J K H J H F J E V P L J J J
V U P A S M A E R D T K S I O

ASH HEAP

DREAMS

MERCIES

COMMAND

GOD

SLEEP

DANIEL

LATTER DAYS

VISION

DECREE

NEBUCHADNEZZAR

WISE MEN

DESTROY

156. NEBUCHADNEZZAR'S DREAM (DANIEL 2:1-49)

MEMORY VERSE:

"Truly your God is the God of gods, the Lord of kings, and a revealer of secrets." DANIEL 2:47

FILL IN THE BLANK:

1. "Now in the second year of Nebuchadnezzar's reign, Nebuchadnezzar had _____." DANIEL 2:1

TRUE OR FALSE:

2. "His spirit was so troubled that his sleep left him." DANIEL 2:1
TRUE OR FALSE

CIRCLE THE CORRECT WORDS:

3. "Then the king gave the command to call the ...

magicians

clowns

queen

astrologers

sorcerers

Chaldeans

to tell the king his dreams." DANIEL 2:2

TRUE OR FALSE:

4. The king said to them, "If you do not make known the dream to me, and its interpretation, you shall be cut in pieces, and your houses shall be made an ash heap." DANIEL 2:5
TRUE OR FALSE
5. The Chaldeans said to the king, "It is a difficult thing that the king requires, and there is no other who can tell it to the king except the gods, whose dwelling is not with flesh." DANIEL 2:11
TRUE OR FALSE
6. For this reason the king was very happy and joyful, and gave a command to celebrate the wisdom of the Chaldeans. DANIEL 2:12
TRUE OR FALSE

FILL IN THE BLANKS:

7. "So the decree went out, and they began _____ the wise men of Babylon." DANIEL 2:13
8. "Daniel went in and asked the king to give him _____, that he might tell the king the interpretation." DANIEL 2:16
9. "Then Daniel went to his house, and made the decision known to Hananiah, Mishael, and Azariah, his companions, that they might seek _____ from the _____ of heaven concerning this secret, so that Daniel and his companions might not perish with the rest of the wise men of Babylon." DANIEL 2:17-18

TRUE OR FALSE:

10. But the secret was not revealed to Daniel or to his companions. DANIEL 2:19
TRUE OR FALSE

FILL IN THE BLANKS:

11. Daniel was brought before the king and said, "There is a God in heaven who reveals secrets, and He has made known to King Nebuchadnezzar what will be in the _____." DANIEL 2:28

156. NEBUCHADNEZZAR'S DREAM

(DANIEL 2:1-49)

L Z X L M E I P C R O S E E Y W D J N A
B F E O E B F C R E O A Z N G Y I C S O
M W W U T D B V P N K U P A M U C H B I
I X G P L V L U R V P K E I M K H N A L
O Y F W M N A S E I C R E M L E I N A D
X D N A M M O C E T Z S U P A Y P V S D
K L Z C E R E I M O S Y D P U H L D P S
E N A S Z P A P H J T R V Q V F O I W U
Y D N Y I Y Z Z Y Q E X W I S E M E N J
T C S A I G C N Z A V F F F E Q P M J L
E V H D D N L S M E G L I R Z N E O H J
Z O U R Z W W S Y L N K U C U H E O N T
Q S S E P N C Y M P W D H G U M R F F B
V K Y T Z Y O C O V D I A O I G C L G V
L L J T V Z A I B R K Q I H M Q E D I Q
S D N A U U Z N S G T S P W C W D I E O
R F D L S L E E P I G S K J Q U D V G V
S A Y P D G S P P Y V O E V B G B E W Y
B B I R W F D C R Q A S D D V M Q E K X
B R B F E Y G R Y D G O R H B W J M N C

ASH HEAP

DREAMS

NEBUCHADNEZZAR

COMMAND

GOD

SLEEP

DANIEL

LATTER DAYS

VISION

DECREE

MERCIES

WISE MEN

DESTROY

156. NEBUCHADNEZZAR'S DREAM

(DANIEL 2:1-49)

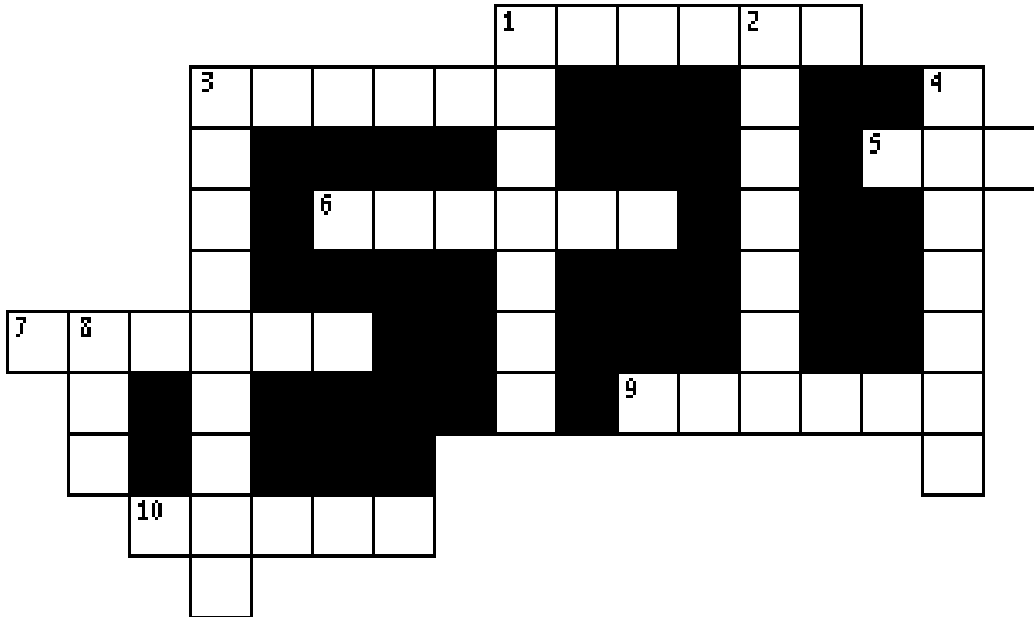

- 1 ACROSS "Now in the second year of Nebuchadnezzar's reign, Nebuchadnezzar had ____." **DANIEL 2:1**
- 10 ACROSS "His spirit was so troubled that his ____ left him." **DANIEL 2:1**
- 4 DOWN "Then the king gave the ____ to call the magicians, the astrologers, the sorcerers and the Chaldeans to tell the king his dreams." **DANIEL 2:2**
- 8 DOWN The king said to them, "If you do not make known the dream to me, and its interpretation, you shall be cut in pieces, and your houses shall be made an ____ heap." **DANIEL 2:5**
- 3 DOWN The Chaldeans said to the king, "It is a ____ thing that the king requires, and there is no other who can tell it to the king except the gods, whose dwelling is not with flesh." **DANIEL 2:11**
- 1 DOWN "For this reason the king was angry and very furious, and gave a command to ____ all the wise men of Babylon." **DANIEL 2:12**
- 3 ACROSS "So the ____ went out, and they began killing the wise men of Babylon." **DANIEL 2:13**
- 7 ACROSS " ____ went in and asked the king to give him time, that he might tell the king the interpretation." **DANIEL 2:16**
- 2 DOWN "Then Daniel went to his house, and made the decision known to Hananiah, Mishael, and Azariah, his companions, that they might seek ____ from the God of heaven concerning this secret." **DANIEL 2:17-18**
- 9 ACROSS "Then the secret was revealed to Daniel in a night ____." **DANIEL 2:19**
- 6 ACROSS Daniel was brought before the king and said, "There is a God in heaven who reveals secrets, and He has made known to King Nebuchadnezzar what will be in the ____ days." **DANIEL 2:28**
- 5 ACROSS "Truly your ____ is the God of gods, the Lord of kings, and a revealer of secrets." **DANIEL 2:47**

Bible Story 157

THE FIERY FURNACE

DANIEL 3:1-30

157. THE FIERY FURNACE

(DANIEL 3:1-30)



"Then Nebuchadnezzar the king was astonished, and rose up in haste, *and* spake, and said unto his counsellors, Did not we cast three men bound into the midst of the fire? They answered and said unto the king, True, O king. He answered and said, Lo, I see four men loose, walking in the midst of the fire, and they have no hurt; and the form of the fourth is like the Son of God."

DANIEL 3:24-25

157. THE FIERY FURNACE

(DANIEL 3:1-30)

MEMORY VERSE:

"Blessed be the God of Shadrach, Meshach, and Abed-Nego, who sent His Angel and delivered His servants who trusted in Him." DANIEL 3:28

TRUE OR FALSE:

1. Nebuchadnezzar the king made an image of stone. **DANIEL 3:1**
TRUE OR FALSE

CIRCLE THE CORRECT WORDS:

2. "To you it is commanded, O peoples, nations, and languages, that at the time you hear the sound of the horn, flute, harp lyre and psaltery, in symphony with all kinds of music, you shall fall down and (**POLISH, WORSHIP**) the gold image that King Nebuchadnezzar has set up." **DANIEL 3:4-5**
3. "Whoever does not fall down and worship shall be cast immediately into the midst of a burning fiery (**VOLCANO, FURNACE**)."
DANIEL 3:6

FILL IN THE BLANKS:

Nebuchadnezzar "gave the command to bring Shadrach, Meshach, and Abed-Nego. So they brought these men before the king."

4. "Nebuchadnezzar spoke, saying to them, 'Is it true, Shadrach, Meshach, and Abed-Nego, that you do not _____ my gods or _____ the gold image which I have set up?'" **DANIEL 3:13-14**

TRUE OR FALSE:

5. Nebuchadnezzar said to them, "If you do not worship, you shall be cast immediately into the midst of a burning fiery furnace. And who is the god who will deliver you from my hands?" **DANIEL 3:15**
TRUE OR FALSE

CIRCLE THE CORRECT WORDS:

6. They answered him, "If that is the case, our (**SELVES, GOD**) whom we serve is able to deliver us from the burning fiery furnace, and (**HE, WE**) will deliver us from your hand, O king. But if not let it be known to you, O king, that we do not serve your gods, nor will we worship the gold image which you have set up."
DANIEL 3:17-18
7. "And he commanded certain mighty men of valor who were in his army to (**BIND, FREE**) Shadrach, Meshach, and Abed-Nego, and cast them into the burning fiery furnace." **DANIEL 3:20**
8. "Therefore, because the king's command was urgent, and the furnace exceedingly hot, the flame of the fire (**TICKLED, KILLED**) those men who took up Shadrach, Meshach, and Abed-Nego." **DANIEL 3:22**

TRUE OR FALSE:

9. "And these three men, Shadrach, Meshach, and Abed-Nego, fell down bound into the midst of the burning fiery furnace." **DANIEL 3:23**
TRUE OR FALSE
10. Nebuchadnezzar looked into the burning fiery furnace and said, "I see four men loose, walking in the midst of the fire; and they are not hurt, and the form of the fourth is like the Son of God." **DANIEL 3:25**
TRUE OR FALSE
11. The king said, "Leave them all in there until they and the burning fiery furnace are consumed!" **DANIEL 3:26**
TRUE OR FALSE

157. THE FIERY FURNACE

(DANIEL 3:1-30)

S B U G L B B Z H P P M Q U T
H D O K S I I Y A L J F O H E
A R F B N A T Y H J H S E P V
D C L D V C R E V I L E D E R E
R G O G E N D E B A G O D V E
A R F U R W E O Z G O L D A S
C G L I C J J J Y C Q W W R C
H N M K R U K E G A M I E L S
I R A Z Z E N D A H C U B E N
N G S C M P I H S R O W B W C
G Z E C A N R U F V O U K J H
Y J Z U L B B F N T A D S U U
S O N O F G O D J W W S H O E
P P F M B O P A T H V J O E C
Y N P D H C A H S E M H T P N

ABED-NEGO	FURNACE	IMAGE	SHADRACH
BIND	GOD	MESHACH	SON OF GOD
DELIVER	GOLD	SERVE	WORSHIP
FIRE	HOT	NEBUCHADNEZZAR	

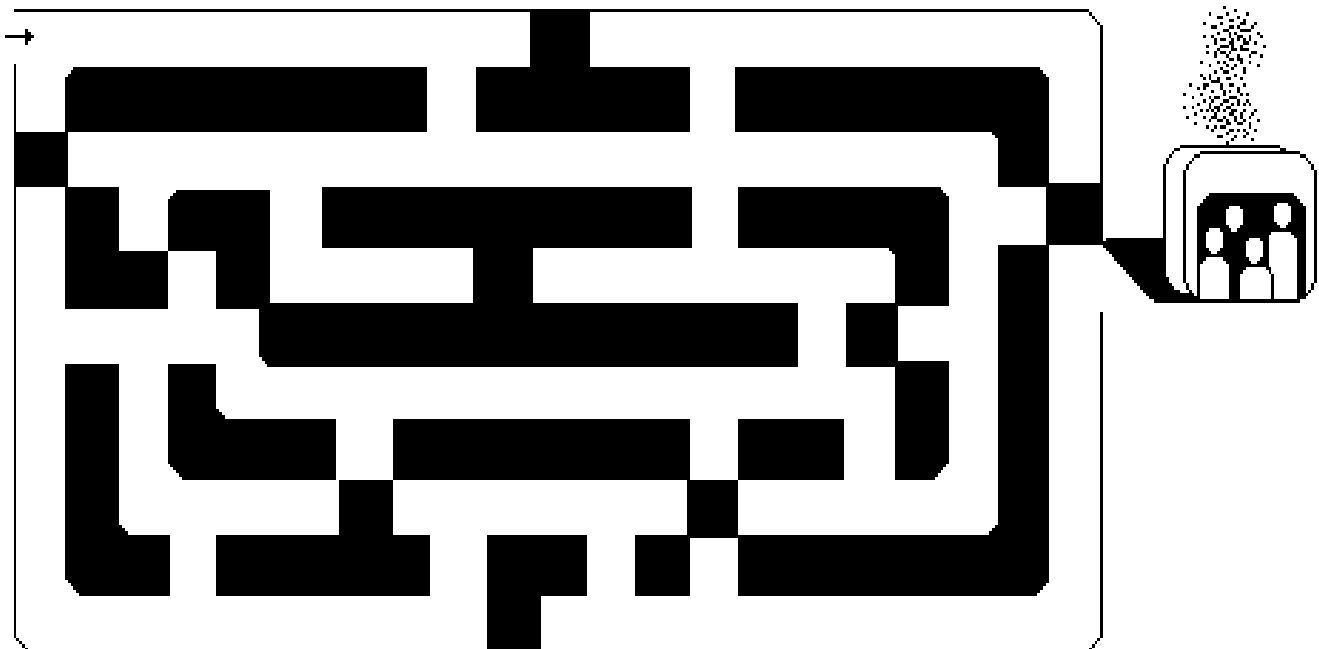

157. THE FIERY FURNACE

(DANIEL 3:1-30)

MEMORY VERSE:

"Blessed be the God of Shadrach, Meshach, and Abed-Nego, who sent His Angel and delivered His servants who trusted in Him." DANIEL 3:28

TRUE OR FALSE:

1. Nebuchadnezzar the king made an image of stone. DANIEL 3:1
TRUE OR FALSE

FILL IN THE BLANKS:

2. "To you it is commanded, O peoples, nations, and languages, that at the time you hear the sound of the horn, flute, harp lyre and psaltery, in symphony with all kinds of music, you shall fall down and _____ the gold image that King Nebuchadnezzar has set up." DANIEL 3:4-5
3. "Whoever does not fall down and worship shall be cast immediately into the midst of a burning fiery _____." DANIEL 3:6

Nebuchadnezzar "gave the command to bring Shadrach, Meshach, and Abed-Nego. So they brought these men before the king."

4. "Nebuchadnezzar spoke, saying to them, 'Is it true, Shadrach, Meshach, and Abed-Nego, that you do not _____ my gods or _____ the gold image which I have set up?'" DANIEL 3:13-14

TRUE OR FALSE:

5. Nebuchadnezzar said to them, "If you do not worship, you shall be cast immediately into the midst of a burning fiery furnace. And who is the god who will deliver you from my hands?" DANIEL 3:15
TRUE OR FALSE

FILL IN THE BLANKS:

6. They answered him, "If that is the case, our _____ whom we serve is able to deliver us from the burning fiery furnace, and _____ will deliver us from your hand, O king. But if not let it be known to you, O king, that we do not serve your gods, nor will we worship the gold image which you have set up." DANIEL 3:17-18
7. "And he commanded certain mighty men of valor who were in his army to _____ Shadrach, Meshach, and Abed-Nego, and _____ them into the burning fiery furnace." DANIEL 3:20

CIRCLE THE CORRECT WORD:

8. "Therefore, because the king's command was urgent, and the furnace exceedingly hot, the flame of the fire (TICKLED, KILLED) those men who took up Shadrach, Meshach, and Abed-Nego." DANIEL 3:22

FILL IN THE BLANKS:

9. "And these three men, _____, _____, and _____ - _____, fell down bound into the midst of the burning fiery furnace." DANIEL 3:23
10. Nebuchadnezzar looked into the burning fiery furnace and said, "I see _____ men loose, walking in the midst of the fire; and they are not hurt, and the form of the fourth is like the Son of God." DANIEL 3:25

TRUE OR FALSE:

11. The king said, "Leave them all in there until they and the burning fiery furnace are consumed!" DANIEL 3:26
TRUE OR FALSE

157. THE FIERY FURNACE (DANIEL 3:1-30)

O P D C J L W O F U A B F O K Y N D D G
 J P Z A I P Q B F J Y C O M K M U F W O
 Q R Z L C U O H T S O N O F G O D B T V
 S B P O N T N G Q K Q D J J R A D E L S
 P O O I T E I F E S U W W H C A H S E M
 M S W Z H N B V H N Q K S K E S L H A P
 B L H M C S T U A M D I S G N V U T O T
 B K Q F J D R I C J T E I H C Y F L A W
 O H O T G R A O R H H E B G V K L U P B
 H W I M F O L O W E A P E A C W Y W A H
 S F L Q W I L N U T V D A G C L H Q D J
 S V U S Y S R D U A T I N D A W M N Y Y
 R J H R J A H E T A T I L E H M O I S K
 V B T Q N Z L A T U R Y G E Z W I S M P
 N W Y V D A Z H D E R B W V D Z I V U G
 G E O O T E C I D R W B A B R Z A U J K
 D L G P N D Z E D N A P F G E O R R S G
 P V A B A M N U Q Q P C W C M A F U E P
 K S E R V E N I C B N P H Z Q K Y A J S
 S D V Q S D K A B N K Y T H N U L D M O

ABED-NEGO	FURNACE	IMAGE	SHADRACH
BIND	GOD	MESHACH	SON OF GOD
DELIVER	GOLD	SERVE	WORSHIP
FIRE	HOT	NEBUCHADNEZZAR	

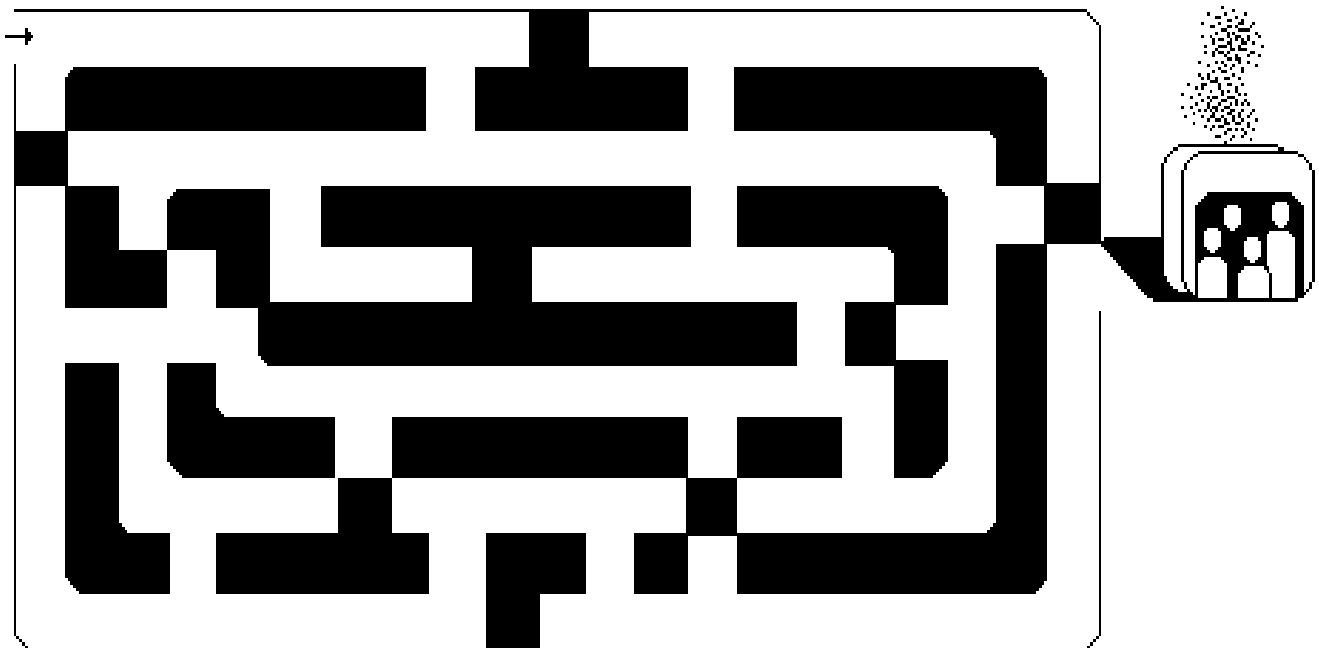

157. The Fiery Furnace

(Daniel 3:1-30)

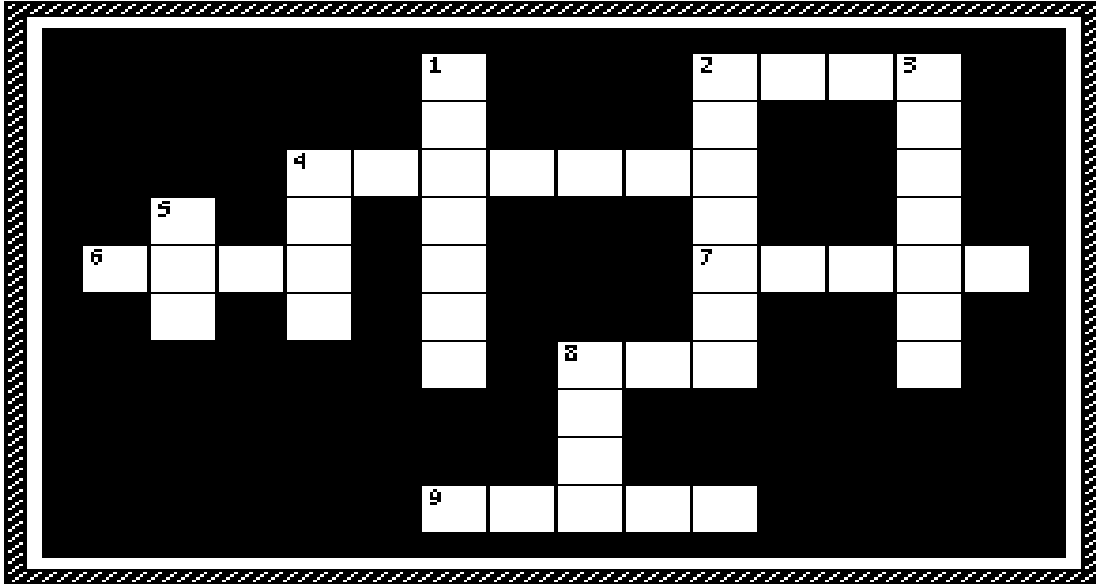

- 8 DOWN "Nebuchadnezzar the king made an image of ____." **DANIEL 3:1**
- 1 DOWN It was commanded, "____ the gold image that King Nebuchadnezzar has set up." **DANIEL 3:5**
- 4 ACROSS "Whoever does not fall down and worship shall be cast immediately into the midst of a burning fiery ____." **DANIEL 3:6**
- 7 ACROSS "Nebuchadnezzar spoke, saying to them, 'Is it true, Shadrach, Meshach, and Abed-Nego, that you do not ____ my gods or worship the gold image which I have set up?' " **DAN 3:13-14**
- 3 DOWN Nebuchadnezzar said to them, "If you do not worship, you shall be cast immediately into the midst of a burning fiery furnace. And who is the god who will ____ you from my hands?" **DANIEL 3:15**
- 8 ACROSS They answered him, "If that is the case, our ____ whom we serve is able to deliver us from the burning fiery furnace, and He will deliver us from your hand, O king." **DANIEL 3:17**
- 2 ACROSS "And he commanded certain mighty men of valor who were in his army to ____ Shadrach, Meshach, and Abed-Nego, and cast them into the burning fiery furnace." **DANIEL 3:20**
- 5 DOWN "Therefore, because the king's command was urgent, and the furnace exceedingly ____." **DANIEL 3:22**
- 9 ACROSS "And these three men, Shadrach, Meshach, and Abed-Nego, fell down bound into the ____ of the burning fiery furnace." **DANIEL 3:23**
- 6 ACROSS Nebuchadnezzar looked into the burning fiery furnace and said, "I see ____ men loose." **DANIEL 3:25**
- 4 DOWN "Then Shadrach, Meshach, and Abed-Nego came from the midst of the ____." **DANIEL 3:26**
- 2 DOWN "____ be the God of Shadrach, Meshach, and Abed-Nego, who sent His Angel and delivered His servants who trusted in Him." **DANIEL 3:28**

Bible Story 158

**NEBUCHADNEZZAR
IS HUMBLD**

DANIEL 4:28-37

158. NEBUCHADNEZZAR IS HUMBLLED

(DANIEL 4:28-37)



"Now I Nebuchadnezzar praise and extol and honour the King of heaven, all whose works are truth, and his ways judgment: and those that walk in pride he is able to abase."

DANIEL 4:37

158. Nebuchadnezzar is Humbled

(Daniel 4:28-37)

MEMORY VERSE:

"Those who walk in pride He is able to abase." DANIEL 4:37

Nebuchadnezzar "was walking about the royal palace of Babylon..."

CIRCLE THE CORRECT WORDS:

1. "The king spoke, saying, 'Is this not the great Babylon, that (I, **GOD**) have built for a royal dwelling by (MY, **HIS**) mighty power and for the honor of (MY, **HIS**) majesty?' " DANIEL 4:30

"While the word was still in the king's mouth, a voice fell from heaven..."

TRUE OR FALSE:

2. The voice said, "King Nebuchadnezzar, to you it is spoken: the kingdom has departed from you!" DANIEL 4:31

TRUE OR FALSE

"That very hour the word was fulfilled concerning Nebuchadnezzar..."

3. "He was driven from men and ate grass like oxen." DANIEL 4:33

TRUE OR FALSE

4. "His body was wet with the dew of heaven till his hair had grown like eagles feathers." DANIEL 4:33

TRUE OR FALSE

5. His nails were like a bird's beak. DANIEL 4:33

TRUE OR FALSE

CIRCLE THE CORRECT WORDS:

6. The king declared, "At the end of the time I, Nebuchadnezzar, lifted my eyes to heaven, and my (HAIR, **UNDERSTANDING**) returned to me." DANIEL 4:34

FILL IN THE BLANKS:

7. "I _____ the Most High and praised and honored Him who lives forever." DANIEL 4:34

CIRCLE THE CORRECT WORDS:

8. "At the same time my (**MONEY, REASON**) was returned to me, and for the glory of my kingdom, my honor and splendor returned to me." DANIEL 4:36

9. He then declared, "Now I, Nebuchadnezzar, praise and extol and honor the King of heaven, all of whose works are (**TRUTH, THROUGH**), and His ways justice." DANIEL 4:37

158. NEBUCHADNEZZAR IS HUMBLLED

(DANIEL 4:28-37)

B H E L B P N T V P W B J R I
L U O D Z H V B Q P Z K T P L
E Q O R F Z Q I Z E K E E N S
S S C E H I H T U R T C J O T
S S N O L Y B A B S K L Z S F
E I F U N V T A U G Q A Z A A
D L K W G V A M A D J W K E Y
J S B J L B Q D N E B S C R Y
Q R A Z Z E N D A H C U B E N
I J Y N G Q F T M P B S T I O
K F E D I R P Y G Z R S I Q O
T F N S R Y H L F C R A O D T
D E P A R T E D H C I R T J E
D O M Z Q E P I A Q A G A Q N
Y P H K I L J O W I H F N R F

BABYLON

GRASS

PRIDE

BLESSED

HAIR

REASON

CLAWS

NEBUCHADNEZZAR

TRUTH

DEPARTED

OXEN

158. NEBUCHADNEZZAR IS HUMBLLED

(DANIEL 4:28-37)

MEMORY VERSE:

"Those who walk in pride He is able to abase." DANIEL 4:37

Nebuchadnezzar "was walking about the royal palace of Babylon..."

FILL IN THE BLANKS:

1. "The king spoke, saying, 'Is this not the great Babylon, that ____ have built for a royal dwelling by ____ mighty power and for the honor of ____ majesty?' " **DANIEL 4:30**

"While the word was still in the king's mouth, a voice fell from heaven..."

2. The voice said, "King Nebuchadnezzar, to you it is spoken: the kingdom has _____ from you!" **DANIEL 4:31**

"That very hour the word was fulfilled concerning Nebuchadnezzar..."

3. "He was driven from men and ate _____ like oxen." **DANIEL 4:33**

TRUE OR FALSE:

4. "His body was wet with the dew of heaven till his hair had grown like eagles feathers." **DANIEL 4:33**

TRUE OR FALSE

5. His nails were like a bird's beak. **DANIEL 4:33**

TRUE OR FALSE

FILL IN THE BLANKS:

6. The king declared, "At the end of the time I, Nebuchadnezzar, lifted my eyes to heaven, and my _____ returned to me." **DANIEL 4:34**

7. "I _____ the Most High and praised and honored Him who lives forever." **DANIEL 4:34**

CIRCLE THE CORRECT WORDS:

8. "At the same time my (**MONEY, REASON**) was returned to me, and for the glory of my kingdom, my honor and splendor returned to me." **DANIEL 4:36**

9. He then declared, "Now I, Nebuchadnezzar, praise and extol and honor the King of heaven, all of whose works are (**TRUTH, THROUGH**), and His ways justice." **DANIEL 4:37**

158. NEBUCHADNEZZAR IS HUMBLLED

(DANIEL 4:28-37)

H L J J Q M Z A Y F U Z C P E Z F H V T
I I K U H I F B J M D U A C M S L I R W
T J V Y F O W R N E W G Z N V T K U H Y
J C O K P D G L D T E F S C T V T P Y U
H J B R O K Y N O S A E R M O H I K G K
B H I B I E L E Y L E D D P J G Q R M Y
C D Y D H R N W I M E Y G R Q W S E P H
E L D S H Y A G B P B I P E L D S N U F
G Q G W Q T D Z A E D F C M P K B A V Q
H H C A U E C R Z Z V B V H V A O I E P
G Y G L F Z T F L E N L U Y B A E P Z H
Q O E C R E V Z O I N A I Y G G Z Q U M
P F W C D Q O A U I P D L Y Y S P F U G
O R E N M V S N P D Y O A M Q A E R I Q
C G Y Z N L R I A H N E P H D U U C L W
S Q B R V S K S W Z G Z N B C W V G Q G
P S Z D S R D E S S E L B P O U J O B X
Q C A Y L S L H C P N C S R O S B W V W
X P N R B B D L P Z W L C Y K Y I E B D
V C R Q G B F S R V Y W N R P H U J N I

BABYLON

GRASS

PRIDE

BLESSED

HAIR

REASON

CLAWS

NEBUCHADNEZZAR

TRUTH

DEPARTED

OXEN

158. NEBUCHADNEZZAR IS HUMBLLED

(DANIEL 4:28-37)

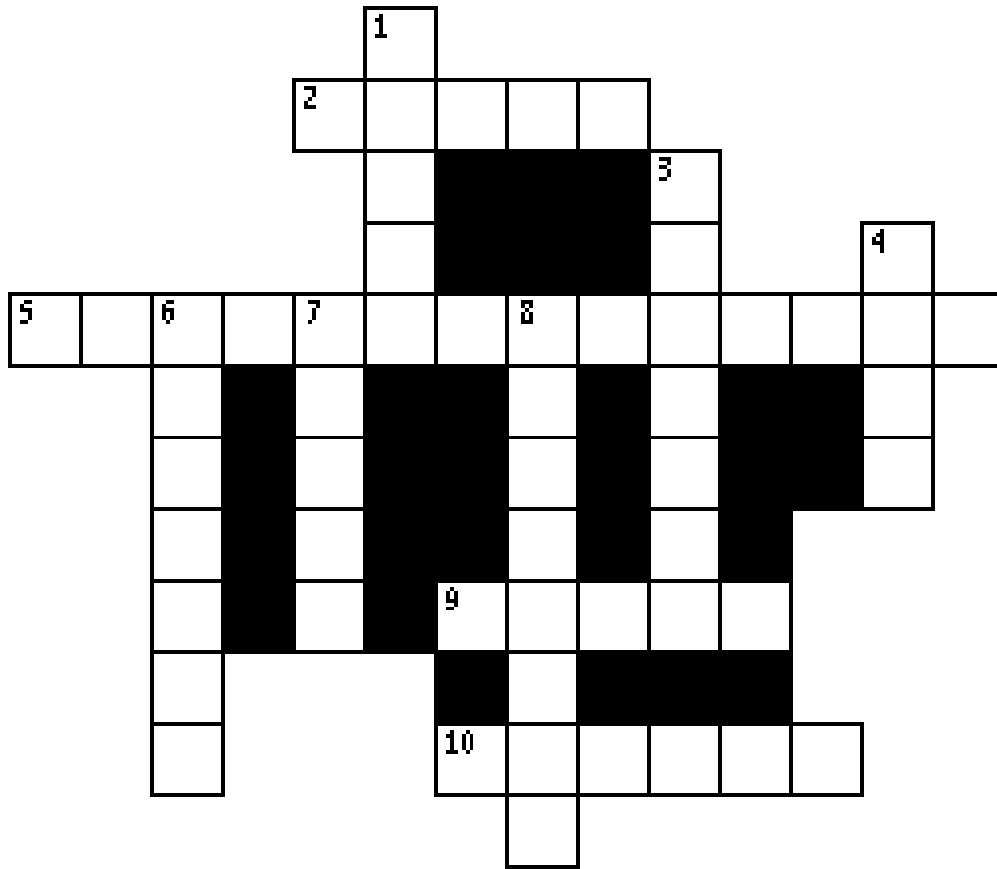

- 6 DOWN "The king spoke, saying, 'Is this not the great _____, that I have built for a royal dwelling by my mighty power and for the honor of my majesty?' " **DANIEL 4:30**
- 8 DOWN The voice said, "King Nebuchadnezzar, to you it is spoken: the kingdom has _____ from you!" **DANIEL 4:31**
- 2 ACROSS "He was driven from men and ate _____ like oxen." **DANIEL 4:33**
- 4 DOWN "His body was wet with the dew of heaven till his _____ had grown like eagles feathers." **DANIEL 4:33**
- 7 DOWN "His nails were like birds' _____." **DANIEL 4:33**
- 5 ACROSS The king declared, "At the end of the time I, _____, lifted my eyes to heaven, and my understanding returned to me." **DANIEL 4:34**
- 3 DOWN "I _____ the Most High and praised and honored Him who lives forever." **DANIEL 4:34**
- 10 ACROSS "At the same time my _____ was returned to me, and for the glory of my kingdom, my honor and splendor returned to me." **DANIEL 4:36**
- 1 DOWN He then declared, "Now I, Nebuchadnezzar, praise and extol and honor the King of heaven, all of whose works are _____, and His ways justice." **DANIEL 4:37**
- 9 ACROSS "Those who walk in _____ He is able to abase." **DANIEL 4:37**

Bible Story 159

THE WRITING ON THE WALL

DANIEL 5:1-31

159. THE WRITING ON THE WALL (DANIEL 5:1-31)



"In the same hour came forth fingers of a man's hand, and wrote over against the candlestick upon the plaister of the wall of the king's palace: and the king saw the part of the hand that wrote."

DANIEL 5:5

159. THE WRITING ON THE WALL

(DANIEL 5:1-31)

MEMORY VERSE:

"The Most High God rules in the kingdom of men, and appoints over it whomever He chooses."
DANIEL 5:21

CIRCLE THE CORRECT WORDS:

1. "Belshazzar the king made a great feast for a (COUPLE, THOUSAND) of his lords, and drank wine in the presence of the (TWO, THOUSAND)." DANIEL 5:1

TRUE OR FALSE:

2. "While he tasted the wine, Belshazzar gave the command to bring the gold and silver vessels which his father Nebuchadnezzar had taken from the temple which had been in Jerusalem." DANIEL 5:2
TRUE OR FALSE
3. "They drank wine, and praised the gods of gold and silver, bronze and iron, wood and stone." DANIEL 5:4
TRUE OR FALSE

CIRCLE THE CORRECT WORDS:

4. "In the same hour the (KNUCKLES, FINGERS) of a man's hand appeared and wrote opposite the lampstand on the plaster of the wall of the king's palace." DANIEL 5:5
5. "Then the king's countenance changed, and his thoughts troubled him, so that the joints of his hips were (LOOSENED, TIGHTENED) and his knees (LOCKED, KNOCKED) against each other." DANIEL 5:6

FILL IN THE BLANK:

6. "Then Daniel was brought in before the king. And the king spoke, and said to Daniel, 'Are you that Daniel who is one of the _____ from Judah, whom my father the king brought from Judah?' " DANIEL 5:13

TRUE OR FALSE:

7. The king said to Daniel, 'If you can read the writing and make known to me its interpretation, you shall be clothed with purple and have a chain of gold around your neck, and shall be the third ruler in the kingdom.' DANIEL 5:16
TRUE OR FALSE
8. Daniel said to the king, "I will take your gifts and your rewards, but I will not read the writing to the king!" DANIEL 5:17
TRUE OR FALSE

MATCHING:

9. "This is the inscription that was written: MENE, MENE, TEKEL, UPHARSIN." DANIEL 5:25
DRAW A LINE TO THE CORRECT INTERPRETATION FOR EACH WORD-
- | | |
|---------------------|--|
| (DANIEL 5:26) MENE | You have been weighed in the balances, and found wanting |
| (DANIEL 5:27) TEKEL | Your kingdom has been divided, and given to the Medes and Persians |
| (DANIEL 5:28) PERES | God has numbered your kingdom, and finished it |

159. THE WRITING ON THE WALL

(DANIEL 5:1-31)

R U B H Q A Q F M N
A N W R I T I N G E
Z K I V D N E S S D
Z U U S G A M K V C
A P A E R Z N E E I
H S R T C A S I R L
S S K D M S H Y E U
L J D A E E U P H L
E D I L R H N Q U N
B J S C H Q K E V J

BELSHAZZAR
DANIEL
FINGERS

MENE
TEKEL
UPHARSIN

VESSELS
WRITING

MENE, MENE,

TEKEL, UPHARSIN

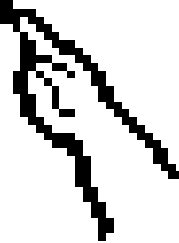

159. THE WRITING ON THE WALL

(DANIEL 5:1-31)

MEMORY VERSE:

"The Most High God rules in the kingdom of men, and appoints over it whomever He chooses."
DANIEL 5:21

FILL IN THE BLANKS:

1. "Belshazzar the king made a great feast for a _____ of his lords, and drank wine in the presence of the _____." DANIEL 5:1

TRUE OR FALSE:

2. "While he tasted the wine, Belshazzar gave the command to bring the gold and silver vessels which his father Nebuchadnezzar had taken from the temple which had been in Jerusalem." DANIEL 5:2
TRUE OR FALSE

UNDERLINE THE CORRECT ANSWER:

3. "They drank wine, and praised the gods of..." DANIEL 5:4
a. gold and silver
b. bronze and iron
c. wood and stone
d. all of the above

FILL IN THE BLANKS:

4. "In the same hour the _____ of a man's hand appeared and wrote opposite the lampstand on the plaster of the wall of the king's palace." DANIEL 5:5
5. "Then the king's countenance changed, and his thoughts troubled him, so that the joints of his hips were _____ and his knees _____ against each other." DANIEL 5:6
6. "Then Daniel was brought in before the king. And the king spoke, and said to Daniel, 'Are you that Daniel who is one of the _____ from Judah, whom my father the king brought from Judah?'" DANIEL 5:13

TRUE OR FALSE:

7. The king said to Daniel, "If you can read the writing and make known to me its interpretation, you shall be clothed with purple and have a chain of gold around your neck, and shall be the third ruler in the kingdom." DANIEL 5:16
TRUE OR FALSE
8. Daniel said to the king, "I will take your gifts and your rewards, but I will not read the writing to the king!" DANIEL 5:17
TRUE OR FALSE

MATCHING:

9. "This is the inscription that was written: MENE, MENE, TEKEL, UPHARSIN." DANIEL 5:25
DRAW A LINE TO THE CORRECT INTERPRETATION FOR EACH WORD-

(DANIEL 5:26) MENE You have been weighed in the balances, and found wanting

(DANIEL 5:27) TEKEL Your kingdom has been divided, and given to the Medes and Persians

(DANIEL 5:28) PERES God has numbered your kingdom, and finished it

159. THE WRITING ON THE WALL

(DANIEL 5:1-31)

I B K Y B A R Z L E K E T H L
A N E B V U K H V Q K T U X U
A H T L L E G K C N W S T O W
U T I E S G S K C Y L A R I Q
E T S N R H H S H M W E O R N
N R E O P P A S E A W F U F I
Q R P I P M R Z D L Z W B Y S
P W W T Y W E E Z O S U L P U
N P R P F A S N T A G N E D P
A N I I O F G R E A R U D F H
Y K T R J W D R E S T A F B A
Q B I C W T V E R G N I L E R
U C N S S O B N E I N D O H S
Q D G N S M G C E V O I Y N I
T W I I I J C L M Y A L F T N

BELSHAZZAR

GODS

RULES

UPHARSIN

DANIEL

INSCRIPTION

TEKEL

VESSELS

FEAST

INTERPRETATION

TROUBLED

WRITING

FINGERS

MENE

MENE, MENE,

TEKEL, UPHARSIN

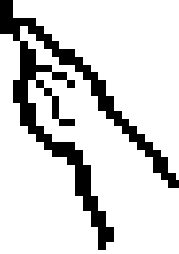

159. THE WRITING ON THE WALL

(DANIEL 5:1-31)

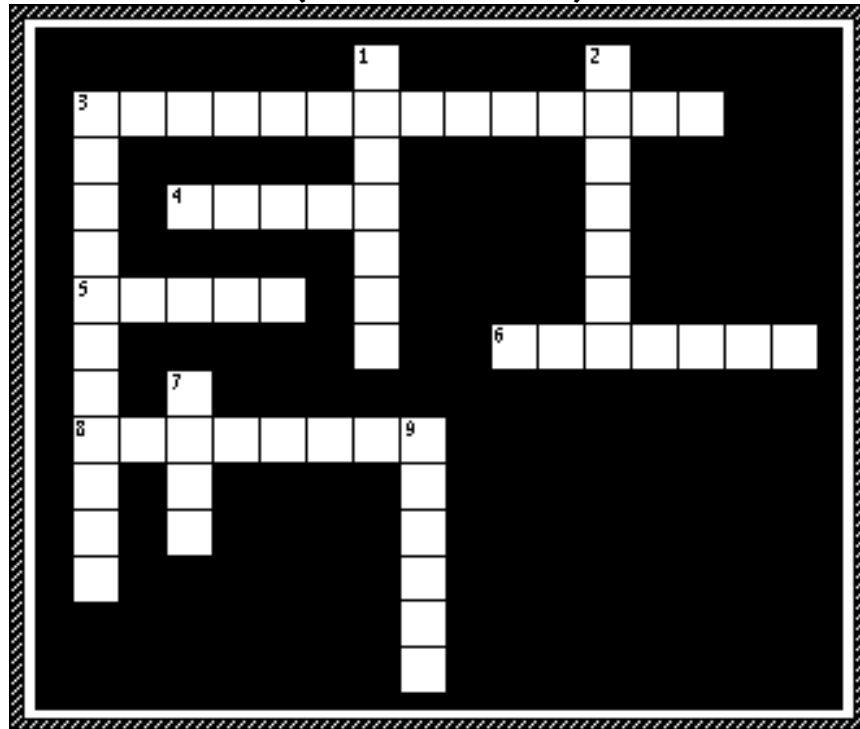

- 4 ACROSS "Belshazzar the king made a great _____ for a thousand of his lords, and drank wine in the presence of the thousand." **DANIEL 5:1**
- 6 ACROSS "While he tasted the wine, Belshazzar gave the command to bring the gold and silver _____ which his father Nebuchadnezzar had taken from the temple which had been in Jerusalem." **DANIEL 5:2**
- 7 DOWN "They drank wine, and praised the _____ of gold and silver, bronze and iron, wood and stone." **DANIEL 5:4**
- 2 DOWN "In the same hour the _____ of a man's hand appeared and wrote opposite the lampstand on the plaster of the wall of the king's palace." **DANIEL 5:5**
- 8 ACROSS "Then the king's countenance changed, and his thoughts _____ him." **DANIEL 5:6**
- 9 DOWN "Then _____ was brought in before the king." **DANIEL 5:13**
- 1 DOWN "The king said to Daniel, 'If you can read the _____ and make known to me its interpretation, you shall be clothed with purple.'" **DANIEL 5:16**
- 3 ACROSS Daniel said to the king, "Let your gifts be for yourself, and give your rewards to another; yet I will read the writing to the king, and make known to him the _____." **DANIEL 5:17**
- 5 ACROSS "The Most High God _____ in the kingdom of men, and appoints over it whomever He chooses." **DANIEL 5:21**
- 3 DOWN "This is the _____ that was written: MENE, MENE, TEKEL, UPHARSIN." **DANIEL 5:25**

Bible Story 160

**DANIEL IN THE
LION'S DEN**

DANIEL 6:1-22

160. DANIEL IN THE LION'S DEN

(DANIEL 6:1-28)



"Then the king commanded, and they brought Daniel, and cast *him* into the den of lions. Now the king spake and said unto Daniel, Thy God whom thou servest continually, he will deliver thee."

DANIEL 6:16

160. DANIEL IN THE LION'S DEN

(DANIEL 6:1-28)

MEMORY VERSE:

"For He is the living God, and steadfast forever." DANIEL 6:26

TRUE OR FALSE:

1. "Daniel distinguished himself above the governors and satraps, because an excellent spirit was in him."
DANIEL 6:3
TRUE OR FALSE
2. The king gave no thought to setting him over the whole realm. DANIEL 6:3
TRUE OR FALSE

FILL IN THE BLANK:

3. "So the governors and satraps sought to find some charge against Daniel concerning the kingdom, but they could find no charge or fault, because he was _____." DANIEL 6:4

CIRCLE THE CORRECT WORDS:

4. Then they told the king, "Whoever petitions any god or man for thirty days, except you, O king, shall be cast into the den of (LIONS, BEARS)." DANIEL 6:7
5. "Now when Daniel knew that the writing was signed, he went home. And in his upper room, with his windows open toward Jerusalem, he knelt down on his knees three times that day, and (CRIED, PRAYED) and gave (THANKS, TEARS) before his God, as was his custom since early days." DANIEL 6:10

FILL IN THE BLANK:

6. Now the men "said before the king, 'That Daniel, who is one of the captives from Judah, does not show due regard for you, O king, or for the decree that you have signed, but makes his _____ three times a day.'" DANIEL 6:13

CIRCLE THE CORRECT WORD:

7. "So the king gave the command, and they brought Daniel and cast him into the den of lions. But the king spoke, saying to Daniel, 'Your God, whom you serve continually, He will (DELIVER, FORGET) you.'" DANIEL 6:16

TRUE OR FALSE:

8. "Then the king arose very early in the morning and went in haste to the den of lions." DANIEL 6:19
TRUE OR FALSE

CIRCLE THE CORRECT WORD:

9. The king called down to Daniel and he replied, "My God sent His angel and shut the lions' (EARS, MOUTHS), so that they have not hurt me, because I was found innocent before Him; and also, O king, I have done no wrong before you." DANIEL 6:22

TRUE OR FALSE:

10. "So Daniel was taken up out of the den, and no injury whatever was found on him, because he believed in his God." DANIEL 6:23
TRUE OR FALSE

160. DANIEL IN THE LION'S DEN

(DANIEL 6:1-28)

P I K W G V A I Z E K J J D F
E L B J B B Q A U S K T Z J A
T S Y N G Q F M A G Q E Z R Y
I J N S R Y H M N D J S K E Y
T F L U F H T I A F B P C V O
I F M Z Q E P T M E B I T I F
O O H K I L J Y G P R R I L V
N P L B P N T L F Z B I O E P
Y D O G G N I V I L K T T D S
H E D Z H N O I L C E L A Q V
U O H T U O M I H C F E N R P
Q O R F Z V N O A Q G I R I R
B E L I E V E D W I N N P L A
S C E H I Q D V N W I A I S Y
S F U N V T B Q P Z K D Q T M

BELIEVED

FAITHFUL

MOUTH

DANIEL

KING

PETITION

DEN

LION

PRAY

DELIVER

LIVING GOD

SPIRIT



160. DANIEL IN THE LION'S DEN

(DANIEL 6:1-28)

MEMORY VERSE:

"For He is the living God, and steadfast forever." DANIEL 6:26

TRUE OR FALSE:

1. "Daniel distinguished himself above the governors and satraps, because an excellent spirit was in him." DANIEL 6:3
TRUE OR FALSE
2. The king gave no thought to setting him over the whole realm. DANIEL 6:3
TRUE OR FALSE

FILL IN THE BLANKS:

3. "So the governors and satraps sought to find some charge against Daniel concerning the kingdom, but they could find no charge or fault, because he was _____." DANIEL 6:4
4. Then they told the king, "Whoever petitions any god or man for thirty days, except you, O king, shall be cast into the den of _____." DANIEL 6:7
5. "Now when Daniel knew that the writing was signed, he went home. And in his upper room, with his windows open toward Jerusalem, he knelt down on his knees three times that day, and _____ and gave _____ before his God, as was his custom since early days." DANIEL 6:10
6. Now the men "said before the king, 'That Daniel, who is one of the captives from Judah, does not show due regard for you, O king, or for the decree that you have signed, but makes his _____ three times a day.'" DANIEL 6:13
7. "So the king gave the command, and they brought Daniel and cast him into the den of lions. But the king spoke, saying to Daniel, 'Your God, whom you serve continually, He will _____ you.'" DANIEL 6:16

TRUE OR FALSE:

8. "Then the king arose very early in the morning and went in haste to the den of lions." DANIEL 6:19
TRUE OR FALSE

CIRCLE THE CORRECT WORD:

9. The king called down to Daniel and he replied, "My God sent His angel and shut the lions' (**EARS, MOUTHS**), so that they have not hurt me, because I was found innocent before Him; and also, O king, I have done no wrong before you." DANIEL 6:22

TRUE OR FALSE:

10. "So Daniel was taken up out of the den, and no injury whatever was found on him, because he believed in his God." DANIEL 6:23
TRUE OR FALSE
11. "And the king gave the command, and they brought those men who had accused Daniel, and they cast them into the den of lions." DANIEL 6:24
TRUE OR FALSE

160. DANIEL IN THE LION'S DEN

(DANIEL 6:1-28)

A W J S N B V P U Z T J V A Z D M R K P
M L E I N A D J A C E Q T W W R S W K L
F Q Q J M Z V T N C J L D L B C Z M P J
H T I F H F B B M Q Z I S E M G F L Z C
K A K F L H Q I G I Z O V Z Y R P B Y V
M U N O I T I T E P K N M R W A G W R T
N O T O D N Y A F W C S A P U G R A O W
C U U P R G E M H Z T R Z J F N K P J H
U H D T E V L V R K I I S T I R I P S P
Q E Y E H G N E A K L L H H I G B W F J
D R H O U S V T W Q O I M G R Z U W A H
C D E V E I L E B J T S V E G J K J H Q
N J U O L R V Y R B A T R I Y P C U A O
W S Q E W Q Q L P B N F S U N N U K H A
T T D C J I T I E R R A V W P G M O Z W
I A S F N P A O S B P Y O G Y U G I Y V
F A I T H F U L G K I Y N D B O D O N M
W Z S K S H Q V D E Q I J W D F L T D F
P S I B Z Z F Q E F K O J Y E L S E J S
P D L Y K I H Z P J D F E P N L V J T W

BELIEVED
DANIEL
DELIVER
DEN

FAITHFUL
KING
LIONS
LIVING GOD

MOUTHS
PETITION
PRAYED
SPIRIT



160. DANIEL IN THE LION'S DEN

(DANIEL 6:1-28)

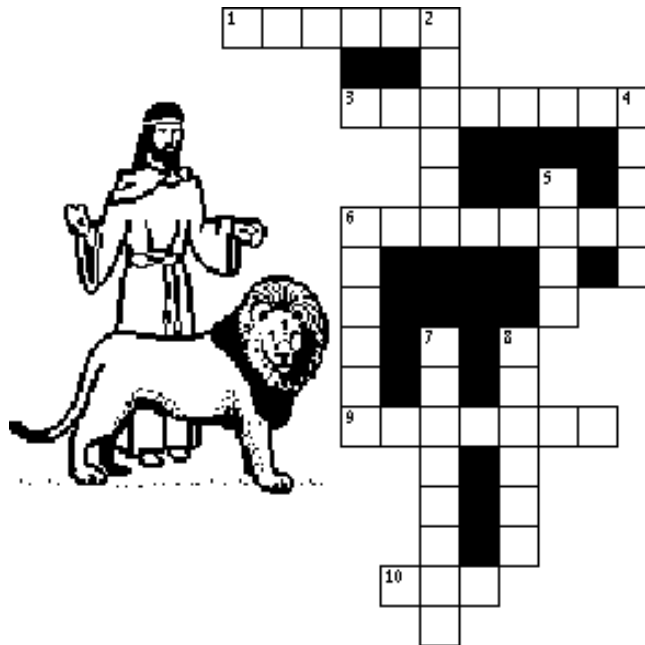

- 2 DOWN "Daniel distinguished himself above the governors and satraps, because an excellent _____ was in him." **DANIEL 6:3**
- 5 DOWN "The _____ gave thought to setting him over the whole realm." **DANIEL 6:3**
- 3 ACROSS "So the governors and satraps sought to find some charge against Daniel concerning the kingdom, but they could find no charge or fault, because he was _____." **DANIEL 6:4**
- 4 DOWN Then they told the king, 'Whoever petitions any god or man for thirty days, except you, O king, shall be cast into the den of _____.' **DANIEL 6:7**
- 6 DOWN "In his upper room, with his windows open toward Jerusalem, he knelt down on his knees three times that day, and _____ and gave thanks before his God, as was his custom since early days."
DANIEL 6:10
- 6 ACROSS Now the men "said before the king, 'That Daniel, who is one of the captives from Judah, does not show due regard for you, O king, or for the decree that you have signed, but makes his _____ three times a day.'" **DANIEL 6:13**
- 9 ACROSS "So the king gave the command, and they brought Daniel and cast him into the den of lions. But the king spoke, saying to Daniel, 'Your God, whom you serve continually, He will _____ you.'" **DANIEL 6:16**
- 10 ACROSS "Then the king arose very early in the morning and went in haste to the _____ of lions."**DANIEL 6:19**
- 1 ACROSS "My God sent His angel and shut the lions' _____, so that they have not hurt me, because I was found innocent before Him; and also, O king, I have done no wrong before you." **DAN 6:22**
- 7 DOWN "So Daniel was taken up out of the den, and no injury whatever was found on him, because he _____ in his God." **DANIEL 6:23**
- 8 DOWN "For He is the _____ God, and steadfast forever." **DANIEL 6:26**

Bible Story 161

**JONAH AND
THE GREAT FISH**

JONAH 1:1-2:10

161. JONAH AND THE GREAT FISH

(JONAH 1:1-2:10)

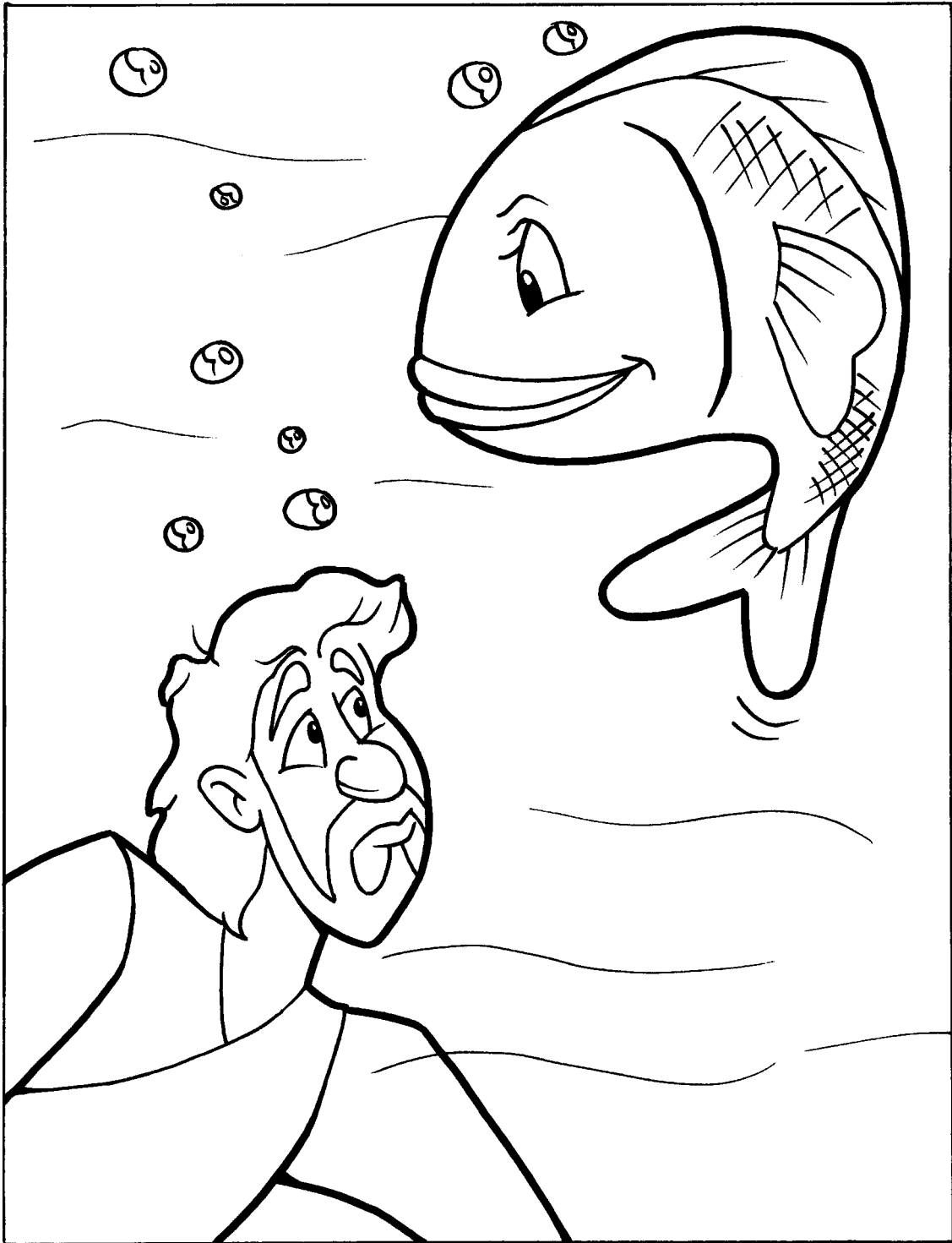

"So they took up Jonah, and cast him forth into the sea: and the sea ceased from her raging."

JONAH 1 : 15

"Now the LORD had prepared a great fish to swallow up Jonah. And Jonah was in the belly of the fish three days and three nights."

JONAH 1 : 17

161. JONAH AND THE GREAT FISH

(JONAH 1:1-2:10)

MEMORY VERSE:

"For as Jonah was three days and three nights in the belly of the great fish, so will the Son of Man be three days and three nights in the heart of the earth."
Matthew 12:40

TRUE OR FALSE:

1. The word of the LORD came to Jonah, saying, "Arise, go to Nineveh, that great city, and cry out against it." **JONAH 1:1-2**
TRUE OR FALSE
2. "But Jonah arose to flee to Tarsish from the presence of the LORD." **JONAH 1:3**
TRUE OR FALSE
3. The sea remained as smooth as glass and the whole journey went by smoothly. **JONAH 1:4**
TRUE OR FALSE

FILL IN THE BLANKS:

4. Jonah "said to them, 'I am a Hebrew; and I fear the LORD, the God of heaven, who made the sea and the dry land.' Then the men were exceedingly _____." **JONAH 1:9-10**
5. Jonah "said to them, 'Pick _____ up and throw _____ into the sea; then the sea will be calm for you. For I know that this great tempest is because of ____.'" **JONAH 1:12**

TRUE OR FALSE:

6. The men "picked up Jonah and threw him into the sea, and the sea ceased from its raging." **JONAH 1:15**
TRUE OR FALSE
7. "Now the LORD had prepared a great fish to swallow Jonah. And Jonah was in the belly of the fish three days and three nights." **JONAH 1:17**
TRUE OR FALSE
8. "Then Jonah prayed to the LORD his God from the fish's belly." **JONAH 2:1**
TRUE OR FALSE

CIRCLE THE CORRECT WORD:

9. "So the LORD (**RAN**, **SPOKE**) to the fish, and it vomited Jonah onto dry land." **JONAH 2:10**

161. JONAH AND THE GREAT FISH

(JONAH 1:1-2:10)

T K J L J O A P D Z E L S S P
 A D S O I U T A V L A E S M D
 R D N T P G W N S U M P M S E
 S A U S T F W O L L A W S R Y
 H O S Y A D E E R H T M O E A
 I K E N V K L V M T H C A N R
 S Q A R R D B E L L Y C T I P
 H K V Y F B A D I A R F A R M
 U S T H G I N E E R H T M A G
 E L D Y E N I A T P A C Z M E
 C W H E V E N I N M N V D N I
 N L O R D K P Q C O O Z N P K
 W I C K E D N E S S B K I C L
 Q K Q D J K H S I F N F W D P
 L I E J T S E P M E T K J T P

AFRAID
 BELLY
 CAPTAIN
 FISH
 JONAH

LORD
 LOTS
 MARINERS
 NINEVEH
 PRAYED

SEA
 SWALLOW
 TARSHISH
 TEMPEST

THREE DAYS
 THREE NIGHTS
 WICKEDNESS
 WIND

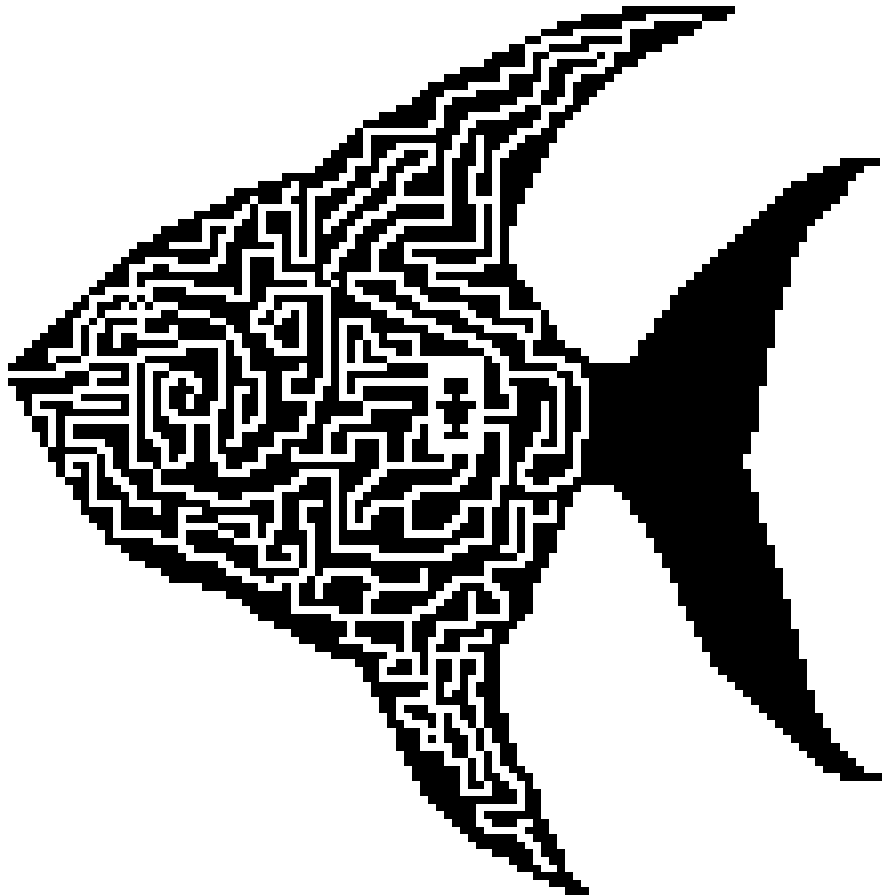

HELP JONAH FIND HIS WAY OUT OF THE GREAT FISH'S BELLY

161. JONAH AND THE GREAT FISH

(JONAH 1:1-2:10)

MEMORY VERSE:

"For as Jonah was three days and three nights in the belly of the great fish, so will the Son of Man be three days and three nights in the heart of the earth."
Matthew 12:40

FILL IN THE BLANKS:

1. The word of the LORD came to Jonah, saying, "Arise, go to _____, that great city, and cry out against it." **JONAH 1:1-2**
2. "But Jonah arose to flee to _____ from the presence of the LORD." **JONAH 1:3**

TRUE OR FALSE:

3. The sea remained as smooth as glass and the whole journey went by smoothly. **JONAH 1:4**

TRUE OR FALSE

FILL IN THE BLANKS:

4. Jonah "said to them, 'I am a Hebrew; and I fear the LORD, the God of heaven, who made the sea and the dry land.' Then the men were exceedingly_____."
JONAH 1:9-10
5. Jonah "said to them, 'Pick _____ up and throw _____ into the sea; then the sea will be calm for you. For I know that this great tempest is because of ____."
JONAH 1:12

TRUE OR FALSE:

6. The men "picked up Jonah and threw him into the sea, and the sea ceased from its raging." **JONAH 1:15**

TRUE OR FALSE

7. "Now the LORD had prepared a great fish to swallow Jonah. And Jonah was in the belly of the fish three days and three nights." **JONAH 1:17**

TRUE OR FALSE

FILL IN THE BLANKS:

8. "Then Jonah _____ to the LORD his God from the fish's belly."
JONAH 2:1
9. "So the LORD _____ to the fish, and it vomited Jonah onto dry land."
JONAH 2:10

161. JONAH AND THE GREAT FISH

(JONAH 1:1-2:10)

D C F B M F B A F L I O C J Q O P K R V M T K H C
 Y N I A T P A C V Z N F M F O E T I F Q C J U G Z
 H F H D P P B N W W G L L A A S C J E D C J A F N
 U K N Q T E R R S P Y L B H T S W S J V V G V Y R
 Q I N Y Y S B P V J P M N A E W R A O S Z E G Q P
 W B G E L G K I M H Y S A H M E S E L M K I O D J
 S N X L I D E Q A G B Z C Z P B C U N L F W W C P
 S Y I H S I H S R A T F W Y E K H E U I O B V M Q
 I N G N O E F D Z E D P J N S S U A G C R W Z P M
 L M R N E P J D S U R G U J T U E V F Z K A A O Q
 S H Q V V V R J S W C K K T W H C D K L S P M E F
 B L I Q Q O E Q H E G B T P V D N Q D U M P U A G
 E D P T L Z T H M D A U O H I P Q E B T O U E Y A
 L R H A Z C E R B W R K I A R E L N K M A Z F U M
 L E S S E N D E K C I W R L M E K R K O T V P H M
 Y U Z Q U C J I S Y G F T J F V E Y A E M L T A A
 J W I F A Q Z L V P A C E C S A D N T M Z F O E O
 F J V H N I Z S H Z N U J V W R D Y I X J R O T K
 F N V P M W K T O S G M K T U L O H W G S K N C S
 O S P J G Z C F J W I D K W D W A D L N H K I N C
 T H R E E D A Y S B Z F P H S N K J A O M T J A Y
 P Z A T F K T A J M J L Z P O J Q I P B N Y S I U
 E K Y B H K I Y E W P S Y J J U K P P U P R J Z D
 O B E I A Q O Y A U N V Y J H O L T A L C G Y S Y
 O Z D A W J T O W F U R O H Q E W V X P D I T N G

AFRAID	LORD	SEA	THREE DAYS
BELLY	LOTS	SWALLOW	THREE NIGHTS
CAPTAIN	MARINERS	TARSHISH	WICKEDNESS
FISH	NINEVEH	TEMPEST	WIND
JONAH	PRAYED		

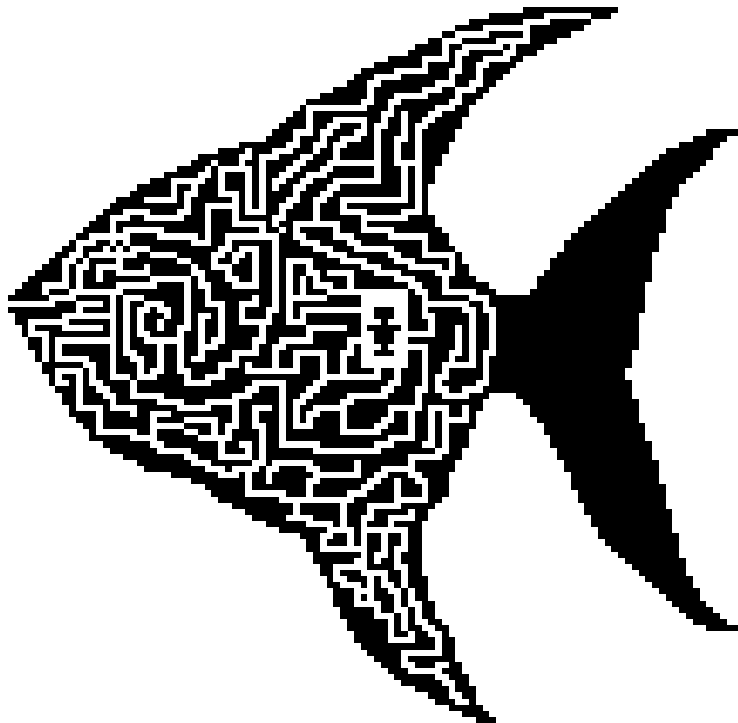

HELP JONAH FIND HIS WAY OUT OF THE GREAT FISH'S BELLY

161. JONAH AND THE GREAT FISH

(JONAH 1:1-2:10)

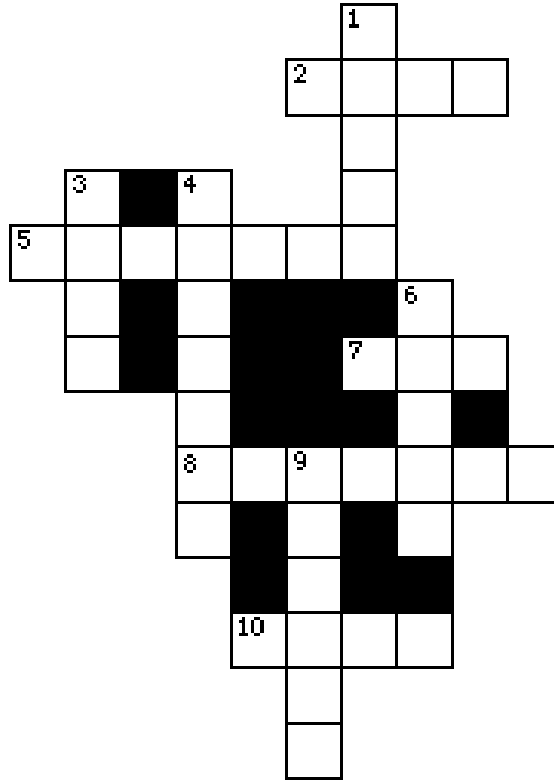

- 1 DOWN "For as _____ was three days and three nights in the belly of the great fish, so will the Son of Man be three days and three nights in the heart of the earth."
MATTHEW 12:40
- 5 ACROSS The word of the LORD came to Jonah, saying, "Arise, go to _____ that great city, and cry out against it." **JONAH 1:1-2**
- 2 ACROSS "But Jonah arose to flee to Tarshish from the presence of the _____." **JONAH 1:3**
- 4 DOWN "But the LORD sent out a great wind on the sea, and there was a mighty _____ on the sea, so that the ship was about to be broken up." **JONAH 1:4**
- 9 DOWN Jonah "said to them, 'I am a Hebrew; and I fear the LORD, the God of heaven, who made the sea and the dry land.' Then the men were exceedingly _____."
JONAH 1:9-10
- 10 ACROSS Jonah "said to them, 'Pick me up and throw me into the sea; then the sea will be for you. For I know that this great tempest is because of me" **JONAH 1:12**
- 7 ACROSS The men "picked up Jonah and threw him into the _____, and the sea ceased from its raging." **JONAH 1:15**
- 8 ACROSS "Now the LORD had prepared a great fish to _____ Jonah. And Jonah was in the belly of the fish three days and three nights." **JONAH 1:17**
- 6 DOWN "Then Jonah prayed to the LORD his God from the fish's _____." **JONAH 2:1**
- 3 DOWN "So the LORD spoke to the _____, and it vomited Jonah onto dry land." **JON 2:10**

Bible Story 162

NINEVEH REPENTS

JONAH 3:1-10

162. NINEVEH REPENTS

(JONAH 3:1-10)



"And Jonah began to enter into the city a day's journey, and he cried,
and said, Yet forty days, and Nineveh shall be overthrown."

JONAH 3: 4

162. NINEVEH REPENTS

(JONAH 3:1-10)

MEMORY VERSE:

"Who can tell if God will turn and relent, and turn away from His fierce anger so that we may not perish?" JONAH 3:9

TRUE OR FALSE:

1. "Now the word of the LORD came to Jonah a second time, saying, 'Arise, go to Nineveh, that great city and preach to it the message that I tell you.' " **JONAH 3:1-2**
TRUE OR FALSE

2. "And Jonah began to enter the city the first day's walk. Then he cried out and said, 'Yet twenty days, and Nineveh shall be overthrown!' " **JONAH 3:4**
TRUE OR FALSE

UNDERLINE THE CORRECT ANSWERS:

3. "So the people of Nineveh..." **JONAH 3:5**
a. believed God
b. proclaimed a fast
c. put on sackcloth from the greatest to the least of them
d. all of the above

4. "Then word came to the king of Nineveh; and..." **JONAH 3:6**
a. he acted like he didn't hear anything
b. covered himself with sackcloth and sat in ashes
c. none of the above

5. "The king caused it to be proclaimed and published throughout Nineveh..." **JONAH 3:7**
a. Let neither man nor beast, herd nor flock, taste anything, do not let them eat, or drink water.
b. Let the taxes be raised!
c. We shall have a national holiday.

TRUE OR FALSE:

6. The king also said, "But let man and beast be covered with sackcloth, and cry mightily to God; yes let everyone turn from his evil way and from the violence that is in his hands." **JONAH 3:8**
TRUE OR FALSE

7. The king said, "Who can tell if God will turn and relent, and turn away from His fierce anger that we may not perish?" **JONAH 3:9**
TRUE OR FALSE

8. When God saw their works, that they turned from their evil way, He brought disaster upon them anyway. **JONAH 3:10**
TRUE OR FALSE

162. NINEVEH REPENTS

(JONAH 3:1-10)

W H E V E N I N E J M Y R M D
 Z R Z I I L O Z R H W T S A F
 K B Z N R U T S E G U B G S L
 K A S H E S F H L E F D N Z S
 Q K D E V E I L E B W O R K S
 J E K O Q S V M N U J R G F V
 D F C T D T R R T W O C Z P R
 E J T A J B S S A D N G J G C
 C H T O L C K C A S A E P K M
 R Y R C D R O L W W H G N B L
 E T W N Q A V V L Y I A U U B
 E E O R R Y M O Z P N S O J B
 F O R T Y D A Y S Z G S F B A
 B J D P I Y A J N W Y E L N C
 B H S I R E P J P B P M L M W

ASHES	FAST	MESSAGE	SACKCLOTH
BELIEVED	FORTY DAYS	NINEVEH	TURN
CRY	JONAH	PERISH	WORD
DECREE	LORD	RELENT	WORKS

WRITE DOWN THE LETTERS AS YOU COME TO THEM ON THE LINES BELOW

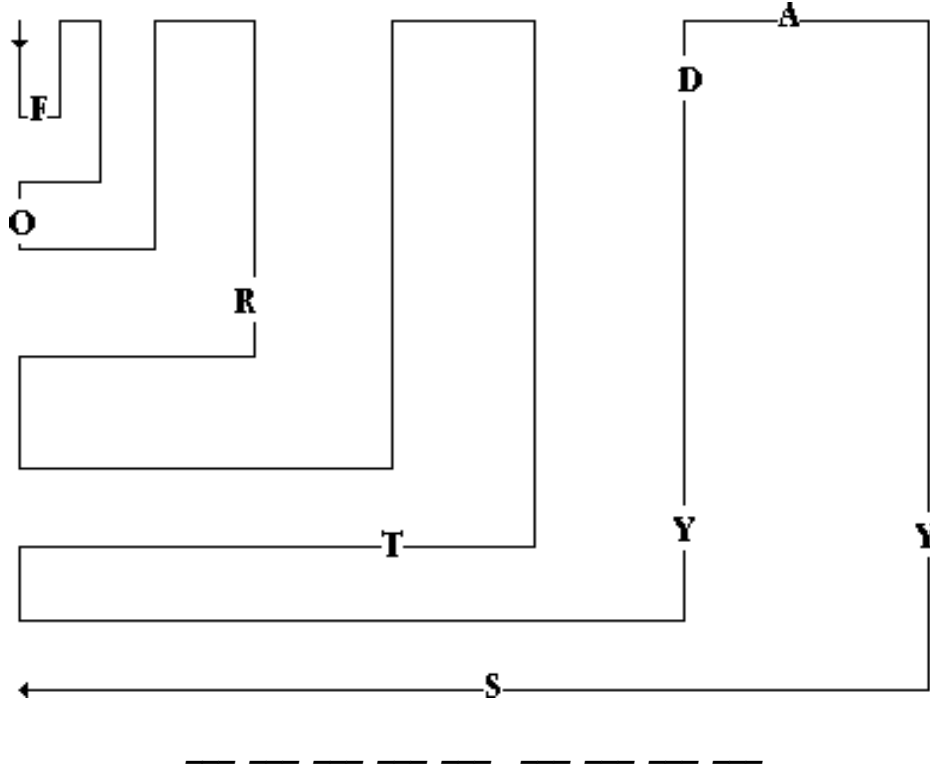

162. NINEVEH REPENTS

(JONAH 3:1-10)

MEMORY VERSE:

"Who can tell if God will turn and relent, and turn away from His fierce anger so that we may not perish?" JONAH 3:9

FILL IN THE BLANKS:

1. "Now the word of the LORD came to Jonah a second time, saying, 'Arise, go to Nineveh, that great city and preach to it the message that _____.' "
JONAH 3:1-2
2. "So Jonah arose and went to Nineveh, according to the word of the LORD. Now Nineveh was an exceedingly great city, a _____ journey in extent."
JONAH 3:3
3. "And Jonah began to enter the city the first day's walk. Then he cried out and said, 'Yet _____ days, and Nineveh shall be overthrown!' " **JONAH 3:4**

UNDERLINE THE CORRECT ANSWERS:

4. "So the people of Nineveh..." **JONAH 3:5**
 - a. believed God
 - b. proclaimed a fast
 - c. put on sackcloth from the greatest to the least of them
 - d. all of the above
5. "Then word came to the king of Nineveh; and..." **JONAH 3:6**
 - a. he acted like he didn't hear anything
 - b. covered himself with sackcloth and sat in ashes
 - c. none of the above
6. "The king caused it to be proclaimed and published throughout Nineveh..." **JONAH 3:7**
 - a. Let neither man nor beast, herd nor flock, taste anything, do not let them eat, or drink water.
 - b. Let the taxes be raised!
 - c. We shall have a national holiday.

FILL IN THE BLANKS:

7. The king also said, "But let man and beast be covered with sackcloth, and _____ mightily to God; yes let everyone _____ from his evil way and from the violence that is in his hands." **JONAH 3:8**
8. The king said, "Who can tell if _____ will turn and relent, and turn away from His fierce anger that we may not perish?" **JONAH 3:9**

TRUE OR FALSE:

9. When God saw their works, that they turned from their evil way, He brought disaster upon them anyway. **JONAH 3:10**

TRUE OR FALSE

162. NINEVEH REPENTS

(JONAH 3:1-10)

R D Z O N V T A B Q H P P R Y T Q E W V P M M F T
 B D R O L B E W R D M Z N C O W O P K R W O R D O
 D C S P S Q E N B J M W U M J R E T I F P M Z R N
 C N D E Z Y R P K Q S B O L F H E C J E A N J K I
 U W J O K E C E E R V M F B A H E L S J N O S K J
 G T Q O B L E S F I O W L R S P W V E P E R I S H
 D J I C Z N D G J L J U L N T J E S E N V B M Y J
 T I O E G A S S E M J F M A R H B C B N T B L R Y
 A W K N F V T D T S E I S C W U W H E S I L P G T
 S P T F A Q Y E E T A R Z W A Q T J A O E N C I H
 T P D K H H L P J F W G F J H O S K R O W H D N G
 O W Y B N T I Z Z A L Y S U A Y S E V U Q P S U F
 T Q H Y G A O C Z Y Z P P A R A J C D G D M T A Y
 W T U N N Q W C K Y B Y G C C W H N Q F W C B A Q
 F A S Y A D Y T R O F B K K H K P Q E W S C B V D
 A U Q M G F Q Q C O P D B O Z V C L N D M V G B C
 M U S H R H Z I T F J R U I Y M E L R B C Z E O M
 F H S L Q P U W I V H C K T N F W K O K Z L I U P
 H E I D I J A Z O F G G C E J S A D Y T L F L V O
 K R L R P T N K T S E R U J T W R D Y K H L L Z E
 B E L I E V E D A V U G M K P U L O D A U S P A A
 N J S E H B M K N M W N D K L D W K J T T M P U Y
 C S J U Z I G Q R A D G L P J S J Q I W M O U E U
 B T F W I A F J P Z W Z S Z C J B K P L O A Z F H
 Q A F J V M H B I S Y J V Y V H O L T A E T V P A

ASHES	FAST	MESSAGE	SACKCLOTH
BELIEVED	FORTY DAYS	NINEVEH	TURN
CRY	JONAH	PERISH	WORD
DECREE	LORD	RELENT	WORKS

WRITE DOWN THE LETTERS AS YOU COME TO THEM ON THE LINES BELOW

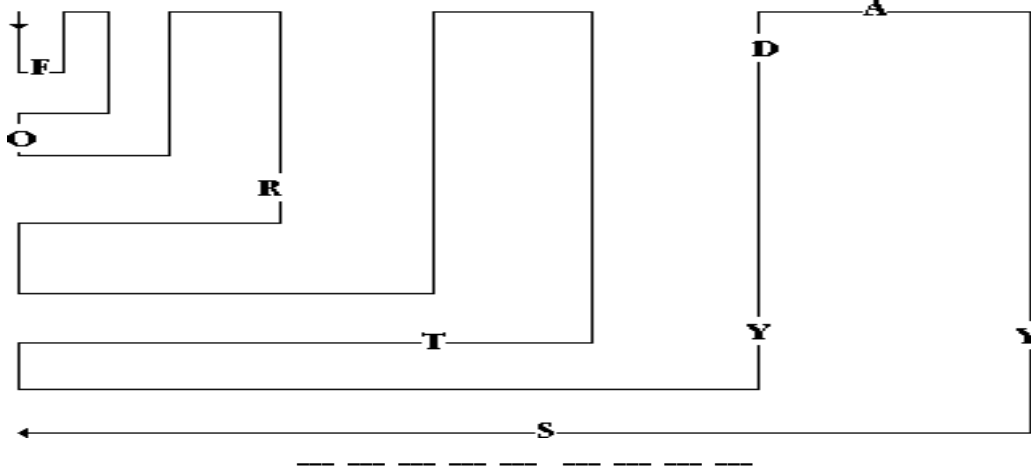

162. NINEVEH REPENTS

(JONAH 3:1-10)

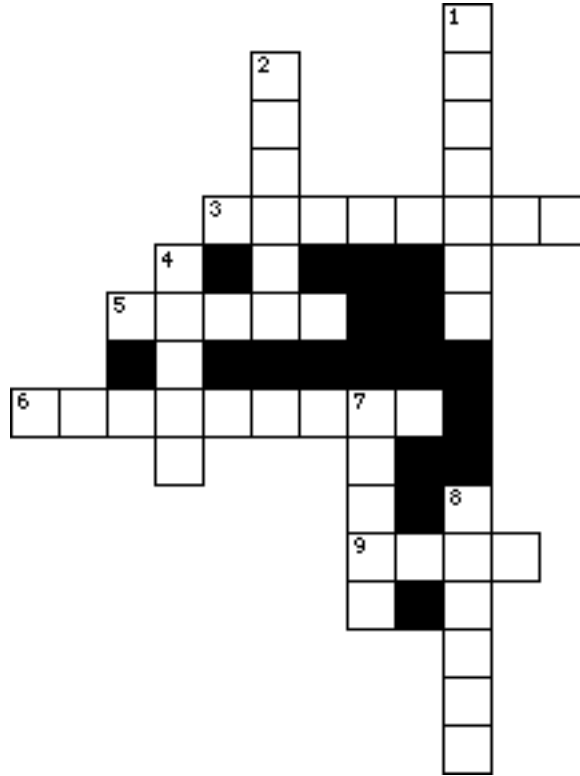

- 2 DOWN "Who can tell if God will turn and _____ and turn away from His fierce anger so that we may not perish?" **JONAH 3:9**
- 8 DOWN "Now the word of the LORD came to Jonah a second time, saying, 'Arise, go to Nineveh, that great city and _____ to it the message that I tell you.'" **JONAH 3:1-2**
- 5 ACROSS "And Jonah began to enter the city the first day's walk. Then he cried out and said, 'Yet _____ days, and Nineveh shall be overthrown!'" **JONAH 3:4**
- 3 ACROSS "So the people of Nineveh _____ God..." **JONAH 3:5**
- 1 DOWN "Then word came to the king of _____; and covered himself with sackcloth and sat in ashes..." **JONAH 3:6**
- 7 DOWN "The king caused it to be proclaimed and published throughout Nineveh "Let neither man nor beast, herd nor flock, _____ anything, do not let them eat, or drink water." **JONAH 3:7**
- 6 ACROSS The king also said, "But let man and beast be covered with _____, and cry mightily to God; yes let everyone turn from his evil way and from the violence that is in his hands." **JONAH 3:8**
- 9 ACROSS The king said, "Who can tell if God will _____ and relent, and turn away from His fierce anger that we may not perish?" **JONAH 3:9**
- 4 DOWN "Then God saw their _____, that they turned from their evil way, and God relented from the disaster that He had said He would bring upon them, and He did not do it." **JONAH 3:10**

Bible Story 163

**JONAH IS
HUMBLED BY GOD**

JONAH 4:1-11

163. JONAH IS HUMBLING BY GOD

(JONAH 4:1-11)



"And the LORD God prepared a gourd, and made *it* to come up over Jonah, that it might be a shadow over his head, to deliver him from his grief. So Jonah was exceeding glad of the gourd."

JONAH 4: 6

163. JONAH IS HUMBLLED BY GOD

(JONAH 4:1-11)

MEMORY VERSE:

"For as the heavens are high above the earth, so great is His mercy toward those who fear Him." PSALM 103:11

Then God saw the works of Nineveh, "that they turned from their evil way; and God relented from the disaster that He had said He would bring upon them, and He did not do it." JONAH 3:10

TRUE OR FALSE:

1. It pleased Jonah exceedingly, and he became happy. **JONAH 4:1**
TRUE OR FALSE
2. "So he prayed to the LORD, and said, 'Ah, LORD, was not this what I said when I was still in my country? Therefore I fled previously to Tarshish; for I know that You are a gracious and merciful God, slow to anger and abundant in lovingkindness, One who relents from doing harm.'" **JONAH 4:2**
TRUE OR FALSE

UNDERLINE THE CORRECT ANSWERS:

3. "Then the Lord said,..." **JONAH 4:4**
 - a. 'Where is your wife?'
 - b. 'Is it right for you to be angry?'
 - c. 'What time is it?'
4. "So Jonah went..." **JONAH 4:5**
 - a. out of the city and sat on the east side of the city
 - b. to see the king.
 - c. home
5. "And the Lord God prepared..." **JONAH 4:6-7**
 - a. a plant and made it come up over Jonah **JONAH 4:6**
 - b. a worm, and it so damaged the plant that it withered **JONAH 4:7**

TRUE OR FALSE:

6. "Then God said to Jonah, 'Is it right for you to be angry about the plant?' " **JONAH 4:9**
TRUE OR FALSE
7. "The LORD said, 'You have had pity on the plant for which you have not labored, nor made it grow, which came up in a night and perished in a night.'" **JONAH 4:10**
TRUE OR FALSE

CIRCLE THE CORRECT WORDS:

8. The LORD said, "And should I not (**PITY, DESTROY**) Nineveh, that (**SMALL, GREAT**) city, in which are more than one hundred and twenty thousand persons who cannot discern between their right hand and their left, and also much livestock?" **JONAH 4:11**

163. JONAH IS HUMBLLED BY GOD

(JONAH 4:1-11)

I T N A L P B H I A Z J E N S
K I O L Z G Q P O J C B J R T
T L O D K R Y J V D O B Z P F
D S C R B Q E T M W E N Z I A
Y J H E V E N I N R C Y A Q Y
H F L E Z I L B Q M O R A H Y
C F F O F P N I Z P Q W K R O
I O B U R H V A U E I B C D P
T S S E N D N I K G N I V O L
Y P B H H Z Q M A S W K T J F
U E Y W A I T X N G Z E I Q V
Q P N J N D A T M Y R G N A N
W I T H E R E D G D B F O R S
S T M N G V Q Y F E R J T I V
S Y H S N V F L H P Q T A L M

ANGRY
CITY
JONAH
LORD

LOVINGKINDNESS
NINEVEH
PITY
PLANT

PRAYED
SHADE
WITHERED
WORM



163. JONAH IS HUMBLLED BY GOD

(JONAH 4:1-11)

MEMORY VERSE:

"For as the heavens are high above the earth, so great is His mercy toward those who fear Him." PSALM 103:11

Then God saw the works of Nineveh, "that they turned from their evil way; and God relented from the disaster that He had said He would bring upon them, and He did not do it." JONAH 3:10

TRUE OR FALSE:

1. It pleased Jonah exceedingly, and he became happy. **JONAH 4:1**
TRUE OR FALSE

FILL IN THE BLANKS:

2. "So he prayed to the LORD, and said, 'Ah, LORD, was not this what I said when I was still in my country? Therefore I fled previously to Tarshish; for I know that You are a _____ and _____ God, slow to anger and abundant in lovingkindness, One who relents from doing harm.'" **JONAH 4:2**

UNDERLINE THE CORRECT ANSWERS:

3. "Then the Lord said,..." **JONAH 4:4**
a. 'Where is your wife?'
b. 'Is it right for you to be angry?'
c. 'What time is it?'
4. "So Jonah went..." **JONAH 4:5**
a. out of the city and sat on the east side of the city
b. to see the king.
c. home
5. "And the Lord God prepared..." **JONAH 4:6-7**
a. a plant and made it come up over Jonah **JONAH 4:6**
b. a worm, and it so damaged the plant that it withered **JONAH 4:7**
c. all of the above

FILL IN THE BLANKS:

6. "Then God said to Jonah, 'Is it _____ for you to be angry about the plant?' "**JONAH 4:9**
7. "The LORD said, 'You have had pity on the plant for which _____ labored nor made it grow, which came up in a night and perished in a night.'" **JONAH 4:10**
8. The LORD said, "And should I not _____ Nineveh, that _____ city, in which are more than one hundred and twenty thousand persons who cannot discern between their right hand and their left, and also much livestock?" **JONAH 4:11**

163. JONAH IS HUMBLLED BY GOD

(JONAH 4:1-11)

U B A U S R H F M K N A G C K J J H P I I P L D A
D C M H I E T H G Q R Z E G C K C Q T J S H A D E
W P F E L U N P F J P S U R U A V O C S P A P T V
R O H R S W A J H B I H W G M H N E S U T B M B B
K G K J J J L T A B Q M D N D K A G C E V V C N O
H U N S F N P B W R D L W G L P T N R L O R D G U
D P C T F S Z I N B J S Y Z S Z W W O Y R Q C E V
P M U H E V E N I N Q V P J V Y H E H J F D V I Z
T N Q A O Z I A P K R O Z P R Y P B U A E V Z K A
B R D Z P K V M E E I J W N C O J K E V J S K R U
H R C S E B V H S F L J B U M J H S C D O M F P E
R D N D O Z B T G J S E M O L F Q U N Q U C K P F
U B W J O F Q Y D T T A W F B A O H Q E G Z S U P
I U T Q C H Y L E E F W U L R H A P L N F L M Z T
W G S S E N D N I K G N I V O L W E K D K U O V O
V D I I F N E I P J A L F L A A V V D E D T A F N
B T W K K G L O P Z Y Z I M C H M A D Y B M T R I
M A P T B N N I Z Z Y D D S W Z F R O A K O M K J
C S P D Y G T V B B O P G Z J Y S L K R K E Z K J
B T W Y N Y V Q R N F J Y F U Y T I C P A M J Y Y
W I T H E R E D Q T V W P P R N W W Q R T X S R T
H O Q H M R Q Z I I N O Y G O J U J K Y W N M G H
P T T U H Q T U W O S R B K I T D U L Y L O B I G
D W A Q L I A A Z T V M D B T P S O W D A B P W F
E F U S D P Q N K A M H R U E L J E K J P U W U Y

ANGRY
CITY
JONAH
LORD

LOVINGKINDNESS
NINEVEH
PITY
PLANT

PRAYED
SHADE
WITHERED
WORM



163. JONAH IS HUMBLLED BY GOD

(JONAH 4:1-11)

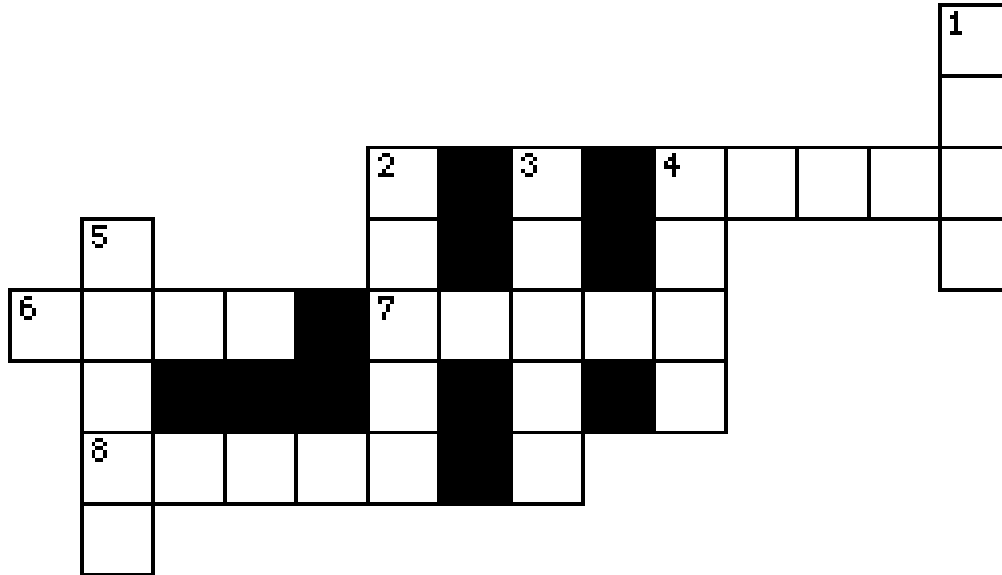

2 DOWN "For as the heavens are high above the earth, so great is His _____ toward those who fear Him." **PSALM 103:11**

Then God saw the works of Nineveh, "that they turned from their evil way; and God relented from the disaster that He had said He would bring upon them, and He did not do it." JONAH 3:10

8 ACROSS "But it displeased Jonah exceedingly, and he became _____." **JONAH 4:1**

6 ACROSS "So he prayed to the _____, and said, 'Ah, LORD, was not this what I said when I was still in my country? Therefore I fled previously to Tarshish; for I know that You are a gracious and merciful God, slow to anger and abundant in lovingkindness, One who relents from doing harm.'" **JONAH 4:2**

7 ACROSS "Then the Lord said, 'Is it _____ for you to be angry?' " **JONAH 4:4**

1 DOWN "So Jonah went out of the _____ and sat on the east side of the city" **JONAH 4:5**

4 ACROSS "And the Lord God prepared a _____ and made it come up over Jonah" **JONAH 4:6**

5 DOWN "Then God said to _____, 'Is it right for you to be angry about the plant?' " **JONAH 4:9**

3 DOWN "The LORD said, 'You have had pity on the plant for which you have not labored, nor made it grow, which came up in a _____ and perished in a night.'" **JONAH 4:10**

4 DOWN The LORD said, "And should I not _____ Nineveh, that great city, in which are more than one hundred and twenty thousand persons who cannot discern between their right hand and their left, and also much livestock?" **JONAH 4:11**